

Head Injury

Triage, assessment, investigation and early management of head injury in children, young people and adults.

Partial update of NICE CG56

Appendices

January 2014

*Commissioned by the National Institute for
Health and Care Excellence*

Disclaimer

Healthcare professionals are expected to take NICE clinical guidelines fully into account when exercising their clinical judgement. However, the guidance does not override the responsibility of healthcare professionals to make decisions appropriate to the circumstances of each patient, in consultation with the patient and/or their guardian or carer.

Copyright

National Clinical Guideline Centre, 2014.

Funding

National Institute for Health and Care Excellence

Contents

Appendix A:	List of stakeholders.....	5
Appendix B:	Declarations of interest	14
Appendix C:	Scope	25
Appendix D:	Review protocols.....	30
Appendix E:	Clinical article selection	42
Appendix F:	Economic article selection.....	48
Appendix G:	Literature search strategies	49
Appendix H:	Clinical evidence tables.....	67
Appendix I:	Economic evidence tables.....	156
Appendix J:	Forest plots	160
Appendix K:	Excluded clinical studies	171
Appendix L:	Excluded economic studies	179
Appendix M:	Cost-effectiveness analysis: Cervical spinal injury clearance strategies	181
Appendix N:	Research recommendations.....	218
Appendix O:	2003 and 2007 guideline appendices	226
Appendix P:	Reference list	580

Appendices

Appendix A: List of stakeholders

- 2gether NHS Foundation Trust
- A.Menarini Pharma U.K. S.R.L.
- Action for Advocacy
- Adults Strategy and Commissioning Unit
- Aintree University Hospital NHS Foundation Trust
- Airedale NHS Trust
- Alder Hey Children's NHS Foundation Trust
- Allocate Software PLC
- Ambulance Service Association
- AOP Orphan Pharmaceuticals
- Archimedes Pharma Ltd
- Arrowe Park Hospital
- Association for Continence Advice
- Association for Family Therapy and Systemic Practice in the UK
- Association of Anaesthetists of Great Britain and Ireland
- Association of British Healthcare Industries
- Association of British Insurers
- Association of British Neurologists
- Association of Chartered Physiotherapists in Neurology
- Association of Educational Psychologists
- Association of Neurophysiological Scientists
- Association of Paediatric Anaesthetists of Great Britain and Ireland
- Association of Paediatric Emergency Medicine
- Association of Professional Music Therapists
- Association of Surgeons of Great Britain and Ireland
- Barchester Healthcare
- Bard Limited
- Barnsley Primary Care Trust
- Bath Spa University
- Baxter Healthcare
- Biophausia AB
- Birmingham & the Black Country Critical Care Network
- Birmingham Children's Hospital NHS Foundation Trust
- Birmingham Community Healthcare Trust
- Boots
- Bradford District Care Trust

- Brain and Spine Foundation
- Brain Injury Rehabilitation Trust
- British Academy of Childhood Disability
- British and Irish Orthoptic Society
- British Association for Counselling and Psychotherapy
- British Association for Music Therapy
- British Association of Behavioural and Cognitive Psychotherapies
- British Association of Critical Care Nurses
- British Association of Music Therapy
- British Association of Neuroscience Nurses
- British Association of Oral and Maxillofacial Surgeons
- British Association of Plastic, Reconstructive and Aesthetic Surgeons)
- British Association of Social Workers
- British Dietetic Association
- British Infection Association
- British Medical Association
- British Medical Journal
- British National Formulary
- British Nuclear Cardiology Society
- British Orthopaedic Association - Patient Liaison group
- British Orthopaedic Association
- British Paediatric Accident & Emergency Group
- British Paediatric Mental Health Group
- British Paediatric Neurology Association
- British Pain Society
- British Paramedic Association
- British Psychological Society
- British Society for Antimicrobial Chemotherapy
- British Society of Paediatric Radiology
- British Society of Interventional Radiology
- British Society of Interventional Radiology
- British Society of Neuroradiologists
- British Society of Paediatric Gastroenterology Hepatology and Nutrition
- British Society of Rehabilitation Medicine
- British Trauma Society
- Calderdale and Huddersfield NHS Trust
- Calderdale Primary Care Trust
- Calderstones Partnerships NHS Foundation Trust
- Cambridge University Hospitals NHS Foundation Trust
- Camden Link
- Capsulation PPS
- Capsulation PPS

- Care Quality Commission (CQC)
- Carers UK
- Central Case Management Ltd
- Central Medical Supplies Ltd
- Changed to British Paediatric Mental Health Group ..British Paediatric Psychology & Psychiatry Group
- Chartered Society of Physiotherapy
- Child Brain Injury Trust
- Children's Commissioner for Wales
- Clarity Informatics Ltd
- Clinical Effectiveness Committee
- College of Emergency Medicine
- College of Occupational Therapists
- Community District Nurses Association
- Community Practitioners' & Health Visitors Association
- Coventry and Warwickshire Cardiac Network
- Covidien Ltd.
- Croydon Clinical Commissioning Group
- Croydon Health Services NHS Trust
- Cumberland Infirmary
- Cyrenians
- David Lewis Centre, The
- Department for Communities and Local Government
- Department of Health
- Department of Health, Social Services and Public Safety - Northern Ireland
- Dietitians in Critical Care
- Disabilities Trust, The
- DO NOT USE (disbanded) Bradford and Airedale Primary Care Trust
- Dorset Primary Care Trust
- Dudley Group Of Hospitals NHS Foundation Trust
- Durham University
- East and North Hertfordshire NHS Trust
- East Kent Hospitals University NHS Foundation Trust
- East Midland Ambulance Services NHS
- East Midlands Ambulance Service NHS
- East Sussex County Council
- Empowerment Matters
- Epilepsy Action
- Expert Patients Programme CIC
- Faculty of Dental Surgery
- Faculty of Forensic and Legal Medicine
- Faculty of Intensive Care Medicine

- Faculty of Intensive Care Medicine
- Faculty of Occupational Medicine
- Faculty of Public Health
- Faculty of Sport and Exercise Medicine
- Federation of Ophthalmic and Dispensing Opticians
- Five Boroughs Partnership NHS Trust
- Foundation Trust Network
- General Medical Council
- Gloucestershire Hospitals NHS Foundation Trust
- Great Ormond Street Hospital
- Great Western Hospitals NHS Foundation Trust
- Greater Manchester Critical Care Network
- Greater Manchester Neurosciences Network
- Greater Manchester West Mental Health NHS Foundation Trust
- Hammersmith and Fulham Primary Care Trust
- Hampshire Ambulance Service NHS Trust
- Harrogate and District NHS Foundation Trust
- Headway - The Brain Injury Association
- Health Protection Agency
- Health Quality Improvement Partnership
- Healthcare Improvement Scotland
- Heart of England NHS Foundation Trust
- Help the Hospices
- Hermal
- Hertfordshire Partnership NHS Trust
- Herts Valleys Clinical Commissioning Group
- Hindu Council UK
- Hip Impact Protection Ltd
- Hockley Medical Practice
- Humber NHS Foundation Trust
- Imperial College Healthcare NHS Trust
- Independent Children's Homes Association
- InferMed
- Institute of Physics and Engineering in Medicine
- Integrity Care Services Ltd.
- Intensive Care National Audit and Research Centre
- Isle of Wight NHS Primary Care Trust
- KCARE
- King's College Hospital NHS Foundation Trust
- Lancashire Care NHS Foundation Trust
- Lancashire Teaching Hospitals NHS Trust
- Leeds Community Healthcare NHS Trust

- Leeds Primary Care Trust (aka NHS Leeds)
- Leeds Teaching Hospitals NHS Trust
- Lewy Body Society, The
- Livability Icanho
- Liverpool Community Health
- Liverpool Primary Care Trust
- London Ambulance Service NHS Trust
- Luton and Dunstable Hospital NHS Trust
- Maidstone and Tunbridge Wells NHS Trust
- Medicines and Healthcare products Regulatory Agency
- Medtronic
- Medway NHS Foundation Trust
- Mental Health Act Commission
- Mental Health Nurses Association
- Mersey Care NHS Trust
- Ministry of Defence
- National Association of Primary Care
- National Clinical Guideline Centre
- National Collaborating Centre for Cancer
- National Collaborating Centre for Mental Health
- National Collaborating Centre for Women's and Children's Health
- National Confidential Enquiry into Patient Outcome and Death
- National Hospital for Neurology & Neurosurgery
- National Institute for Health Research Health Technology Assessment Programme
- National Institute for Health Research
- National Institute for Mental Health in England
- National Patient Safety Agency
- National Public Health Service for Wales
- National Treatment Agency for Substance Misuse
- Neuroanaesthesia Society of Great Britain and Ireland
- NHS Clinical Knowledge Summaries
- NHS Connecting for Health
- NHS County Durham and Darlington
- NHS Direct
- NHS England
- NHS Greater Manchester Commissioning Support Unit
- NHS Halton CCG
- NHS Milton Keynes
- NHS Nottingham City
- NHS Pathways
- NHS Plus
- NHS Sefton

- NHS Sheffield
- NHS Warwickshire North CCG
- NICE technical lead
- Norfolk and Norwich University Hospital
- North Cumbria University Hospitals NHS Trust
- North East & Cumbria Critical Care Network
- North East Ambulance Service Trust
- NORTH EAST LONDON FOUNDATION TRUST
- North Essex Mental Health Partnership Trust
- North Somerset Primary Care Trust
- North Staffordshire Combined Healthcare NHS Trust
- North Tees and Hartlepool NHS Foundation Trust
- North West Ambulance Service NHS Trust
- North West London Critical Care Network
- Northumberland, Tyne & Wear NHS Trust
- Nottingham City Council
- Nottingham City Hospital
- Oxford University Hospitals NHS Trust
- Pain UK
- Parenteral and Enteral Nutrition Group
- Partnerships for Children, Families, Women and Maternity
- PERIGON Healthcare Ltd
- Pfizer
- Pharmametrics GmbH
- Pituitary Foundation
- Primary Care Neurology Society
- Primary Care Pharmacists Association
- Public Health Wales NHS Trust
- Queen Elizabeth Hospital King's Lynn NHS Trust
- Robert Jones & Agnes Hunt Orthopaedic & District Hospital NHS Trust
- Rochdale and District Disability Action Group
- Roche Diagnostics
- Royal Berkshire NHS Foundation Trust
- Royal Brompton Hospital & Harefield NHS Trust
- Royal College of Anaesthetists
- Royal College of General Practitioners
- Royal College of General Practitioners in Wales
- Royal College of Midwives
- Royal College of Nursing
- Royal College of Obstetricians and Gynaecologists
- Royal College of Ophthalmologists
- Royal College of Paediatrics and Child Health

- Royal College of Paediatrics and Child Health , Gastroenterology, Hepatology and Nutrition
- Royal College of Pathologists
- Royal College of Physicians
- Royal College of Psychiatrists
- Royal College of Radiologists
- Royal College of Speech & Language Therapists
- Royal College of Speech and Language Therapists
- Royal College of Surgeons of Edinburgh
- Royal College of Surgeons of England
- Royal National Hospital for Rheumatic Diseases NHS Foundation Trust
- Royal Pharmaceutical Society
- Royal Society of Medicine
- Royal United Hospital Bath NHS Trust
- Salford Primary Care Trust
- Saracen Care Services
- Scottish Intercollegiate Guidelines Network
- SEE BETSI CADWALADR - North Wales NHS Trust
- Sensory Integration Network
- Sheffield Childrens Hospital
- Sheffield Primary Care Trust
- Sheffield Teaching Hospitals NHS Foundation Trust
- Shine
- Social Care Association
- Social Care Institute for Excellence
- Society and College of Radiographers
- Society for Acute Medicine
- Society for Endocrinology
- Society for Research in Rehabilitation
- Society of British Neurological Surgeons
- South Asian Health Foundation
- South Central Ambulance Service NHS Trust
- South London & Maudsley NHS Trust
- South London Cardiac and Stroke Network
- South Wales Critical Care Network
- South West Yorkshire Partnership NHS Foundation Trust
- South Western Ambulance Service NHS Foundation Trust
- Southern General Hospital
- Southport and Ormskirk Hospital NHS Trust
- Speakability
- St Andrews Healthcare
- St Georges Healthcare NHS Trust
- St John Ambulance

- St Mary's Hospital
- Staffordshire Ambulance Service NHS Trust
- Sue Ryder
- Surrey Heart & Stroke Network
- Teva UK
- The Association for Clinical Biochemistry & Laboratory Medicine
- The Association of the British Pharmaceutical Industry
- The College of Social Work
- The Patients Association
- The Priory Group
- The Rotherham NHS Foundation Trust
- The Stroke Association
- The Walton Centre for Neurology and Neurosurgery
- Torbay and Southern Devon Health and Care NHS Trust
- Trafford Healthcare NHS Trust
- Trauma Audit & Research Network
- Triangle
- UK Acquired Brain Injury Forum
- UK Pain Society
- UK Specialised Services Public Health Network
- Unite / Mental Health Nurses Association
- University College London Hospital NHS Foundation Trust
- University Hospital Aintree
- University Hospital Birmingham NHS Foundation Trust
- University Hospital of North Staffordshire NHS Trust
- University Hospital Of South Manchester NHS Foundation Trust
- University Hospitals Birmingham
- University of York
- Vitaline Pharmaceuticals
- Walsall Local Involvement Network
- Walsall Teaching Primary Care Trust
- Welsh Ambulance Services NHS Trust
- Welsh Government
- Wessex Neurological Centre
- Wessex Trauma Network
- West Midlands Ambulance Service NHS Trust
- Western Cheshire Primary Care Trust
- Western Sussex Hospitals NHS Trust
- Westminster Local Involvement Network
- Wiltshire Primary Care Trust
- Wirral University Teaching Hospital NHS Foundation Trust
- Withybush Hospital

- Worcestershire Health and Care NHS Trust
- Wound Care Alliance UK
- York Hospitals NHS Foundation Trust

Appendix B: Declarations of interest

B.1 GDG members

B.1.1 Fiona Lecky

GDG meeting	Declaration of Interests	Action taken
GDG 1 3 rd May 2012	Non-personal pecuniary: Chief investigator for HTA grant to University of Manchester to investigate a decision rule for bypass in head injury (Head Injury Transportation Straight to Neurosurgery (HITS-NS) trial).	Stepped down from chairing review question on bypass to neuroscience when evidence discussed and recommendation amended at GDG 6 and 7.
GDG 2 13 th June 2012	No change.	No action taken.
GDG 3 16 th July 2012	No change.	No action taken.
GDG 4 13 th September 2012	No change.	No action taken.
GDG 5 30 th October 2012	No change.	No action taken.
GDG 6 11 th December 2012	No change.	No action taken.
GDG 7 29 th January 2013	No change.	No action taken.
GDG 8 6 th March 2013	No change.	No action taken.
GDG 9 10 th April 2013	No change.	No action taken.
GDG 10 11 th April 2013	No change.	No action taken.
GDG 11 22 nd May 2013	Non-personal pecuniary: Co-applicant on CENTER-TBI project – FP7 grant on precision medicine and comparative effectiveness research in TBI. Grant has been awarded and will be initiated in October 2013.	No action taken.
GDG 12 28 th October 2013	No change.	No action taken.

B.1.2 Mukul Agarwal

GDG meeting	Declaration of Interests	Action taken
GDG 1 3 rd May 2012	None declared.	No action taken.
GDG 2 13 th June 2012	None declared.	No action taken.
GDG 3 16 th July 2012	Did not attend.	No action taken.
GDG 4 13 th September 2012	None declared.	No action taken.
GDG 5 30 th October 2012	None declared.	No action taken.
GDG 6 11 th December 2012	None declared.	No action taken.
GDG 7 29 th January 2013	None declared.	No action taken.
GDG 8 6 th March 2013	Did not attend.	No action taken.
GDG 9 10 th April 2013	None declared.	No action taken.
GDG 10 11 th April 2013	Did not attend.	No action taken.
GDG 11 22 nd May 2013	None declared.	No action taken.
GDG 12 28 th October 2013	None declared.	No action taken.

B.1.3 Robin Clarke

GDG meeting	Declaration of Interests	Action taken
GDG 1 3 rd May 2012	None declared.	No action taken.
GDG 2 13 th June 2012	None declared.	No action taken.
GDG 3 16 th July 2012	None declared.	No action taken.
GDG 4 13 th September 2012	None declared.	No action taken.
GDG 5 30 th October 2012	Did not attend.	No action taken.
GDG 6 11 th December 2012	None declared.	No action taken.
GDG 7 29 th January 2013	None declared.	No action taken.
GDG 8 6 th March 2013	None declared.	No action taken.
GDG 9 10 th April 2013	None declared.	No action taken.
GDG 10 11 th April 2013	None declared.	No action taken.
GDG 11 22 nd May 2013	Did not attend.	No action taken.
GDG 12 28 th October 2013	Did not attend.	No action taken.

B.1.4 Barbara Green

GDG meeting	Declaration of Interests	Action taken
GDG 1 3 rd May 2012	None declared.	No action taken.
GDG 2 13 th June 2012	Did not attend.	No action taken.
GDG 3 16 th July 2012	None declared.	No action taken.
GDG 4 13 th September 2012	None declared.	No action taken.
GDG 5 30 th October 2012	Did not attend.	No action taken.
GDG 6 11 th December 2012	None declared.	No action taken.

Barbara Green stepped down from the group due to a change in job and was no longer able to commit to the meeting dates going forward.

B.1.5 Kieran Hogarth

GDG meeting	Declaration of Interests	Action taken
GDG 1 3 rd May 2012	None declared.	No action taken.
GDG 2 13 th June 2012	None declared.	No action taken.
GDG 3 16 th July 2012	None declared.	No action taken.
GDG 4 13 th September 2012	None declared.	No action taken.
GDG 5 30 th October 2012	None declared.	No action taken.
GDG 6 11 th December 2012	None declared.	No action taken.
GDG 7 29 th January 2013	None declared.	No action taken.
GDG 8 6 th March 2013	None declared.	No action taken.
GDG 9 10 th April 2013	None declared.	No action taken.
GDG 10 11 th April 2013	None declared.	No action taken.
GDG 11 22 nd May 2013	None declared.	No action taken.
GDG 12 28 th October 2013	None declared.	No action taken.

B.1.6 Peter Hutchinson

GDG meeting	Declaration of Interests	Action taken
GDG 1 3 rd May 2012	Personal specific non-pecuniary: DVLA neurology panel regarding return to driving. Non-personal pecuniary: Co-applicant of EU Framework 7 grant for MRI imaging in mild/moderate head injury (grant to University of Cambridge).	No action taken.
GDG 2 13 th June 2012	No change.	No action taken.
GDG 3 16 th July 2012	Did not attend.	No action taken.
GDG 4 13 th September 2012	No change.	No action taken.
GDG 5 30 th October 2012	Did not attend.	No action taken.
GDG 6 11 th December 2012	No change.	No action taken.
GDG 7 29 th January 2013	No change.	No action taken.
GDG 8 6 th March 2013	No change.	No action taken.
GDG 9 10 th April 2013	No change.	No action taken.
GDG 10 11 th April 2013	Did not attend.	No action taken.
GDG 11 22 nd May 2013	Non-personal pecuniary: Co-applicant on CENTER-TBI project – FP7 grant on precision medicine and comparative effectiveness research in TBI. Grant has been awarded and will be initiated in October 2013.	No action taken.
GDG 12 28 th October 2013	Did not attend.	No action taken.

B.1.7 Gabrielle Lomas

GDG meeting	Declaration of Interests	Action taken
GDG 1 3 rd May 2012	None declared.	No action taken.
GDG 2 13 th June 2012	None declared.	No action taken.
GDG 3 16 th July 2012	None declared.	No action taken.
GDG 4 13 th September 2012	Did not attend.	No action taken.
GDG 5 30 th October 2012	None declared.	No action taken.
GDG 6 11 th December 2012	Did not attend.	No action taken.
GDG 7 29 th January 2013	None declared.	No action taken.
GDG 8 6 th March 2013	None declared.	No action taken.
GDG 9 10 th April 2013	Did not attend.	No action taken.
GDG 10 11 th April 2013	None declared.	No action taken.
GDG 11 22 nd May 2013	None declared.	No action taken.
GDG 12 28 th October 2013	None declared.	No action taken.

B.1.8 Mark Lyttle

GDG meeting	Declaration of Interests	Action taken
GDG 1 3 rd May 2012	<p>Personal non-pecuniary: International consensus guideline development. Contributor to Paediatric Emergency Research Network Project. No personal payment.</p> <p>Non- personal pecuniary: Co-chief investigator of a multi-centre research project in Australasia which is investigating the performance accuracy of paediatric head injury clinical decision rules. An application for an Australian national grant funding has been submitted, but not yet received.</p> <p>Personal non-pecuniary: I have published a systematic review of paediatric head injury clinical decision rules, and will be presenting further research work on the applicability of such rules at the International Conference of Emergency Medicine in June 2012. This applicability work is also in press for publication in a peer reviewed journal.</p>	No action taken.
GDG 2 13 th June 2012	No change.	No action taken.
GDG 3 16 th July 2012	No change.	No action taken.
GDG 4 13 th September 2012	No change.	No action taken.
GDG 5 30 th October 2012	No change.	No action taken.
GDG 6 11 th December 2012	Did not attend.	No action taken.
GDG 7 29 th January 2013	No change.	No action taken.
GDG 8 6 th March 2013	No change.	No action taken.
GDG 9 10 th April 2013	No change.	No action taken.
GDG 10 11 th April 2013	No change.	No action taken.
GDG 11 22 nd May 2013	RCPCH representative on the working group for radiological imaging guideline in development by the Royal College of Radiologists.	No action taken.
GDG 12 28 th October 2013	No change.	No action taken.

B.1.9 David Menon

GDG meeting	Declaration of Interests	Action taken
GDG 1 3 rd May 2012	<p>Personal pecuniary: Paid member of Data Monitoring Committee for Solvay Ltd; Paid consultant for GlaxoSmithKline Ltd; Brainscope Ltd; Ornim Medical; Shire Medical, and Neurovive Ltd. All non-specific.</p> <p>Non-personal pecuniary: Grant funding that focuses on early MR imaging and biomarkers in TBI, and putting together a future grant that covers this. As part of this, negotiations with biomarker companies will take place to obtain equipment (to obtain the best value for the grant). This research is publicly funded (currently by the EU Framework 7 grant process and by the HTA). A meeting is scheduled with Banyan Biomarkers.</p> <p>Personal non pecuniary: Co-Investigator in the HTA funded Risk Adjustment in Neurointensive Care (RAIN) project, which assessed the performance of prognostic schemes in TBI, and the outcome and effectiveness of TBI management in different healthcare locations. Report in the process of being submitted to the HTA.</p>	No action taken.
GDG 2 13 th June 2012	Personal non-pecuniary: he is on the advisory board of One Mind for Research (a campaign in the USA to promote research and improve outcomes from neurological and psychiatric disease).	No action taken.
GDG 3 16 th July 2012	No change.	No action taken.
GDG 4 13 th September 2012	Noted that he had been contacted by AstraZeneca regarding his opinion on a new neuroprotective agent and will meet with them in the next few weeks.	No action taken.
GDG 5 30 th October 2012	Did not attend.	No action taken.
GDG 6 11 th December 2012	No change.	No action taken.
GDG 7 29 th January 2013	No change.	No action taken.
GDG 8 6 th March 2013	No change.	No action taken.
GDG 9 10 th April 2013	Did not attend.	No action taken.
GDG 10 11 th April 2013	Did not attend.	No action taken.
GDG 11 22 nd May 2013	Vice Coordinator on CENTER-TBI project – FP7 grant on precision medicine and comparative effectiveness research in TBI. Grant has been awarded and will be initiated in October 2013.	No action taken.

GDG meeting	Declaration of Interests	Action taken
GDG 12 28 th October 2013	No change.	No action taken.

B.1.10 Lisa Turan

GDG meeting	Declaration of Interests	Action taken
GDG 1 3 rd May 2012	None declared.	No action taken.
GDG 2 13 th June 2012	None declared.	No action taken.
GDG 3 16 th July 2012	Did not attend.	No action taken.
GDG 4 13 th September 2012	None declared.	No action taken.
GDG 5 30 th October 2012	Did not attend.	No action taken.
GDG 6 11 th December 2012	None declared.	No action taken.
GDG 7 29 th January 2013	None declared.	No action taken.
GDG 8 6 th March 2013	None declared.	No action taken.
GDG 9 10 th April 2013	None declared.	No action taken.
GDG 10 11 th April 2013	Did not attend.	No action taken.
GDG 11 22 nd May 2013	None declared.	No action taken.
GDG 12 28 th October 2013	Did not attend.	No action taken.

B.1.11 Paul D Wallman

GDG meeting	Declaration of Interests	Action taken
GDG 1 3 rd May 2012	Personal non-pecuniary. Presentation/lecture on coagulation relating to NICE HI CG56 at the London Trauma Conference. Only expenses claimed.	No action taken.
GDG 2 13 th June 2012	No change.	No action taken.
GDG 3 16 th July 2012	No change.	No action taken.
GDG 4 13 th September 2012	Did not attend.	No action taken.
GDG 5 30 th October 2012	No change.	No action taken.
GDG 6 11 th December 2012	No change.	No action taken.
GDG 7 29 th January 2013	No change.	No action taken.
GDG 8 6 th March 2013	No change.	No action taken.
GDG 9 10 th April 2013	No change.	No action taken.
GDG 10 11 th April 2013	No change.	No action taken.
GDG 11 22 nd May 2013	No change.	No action taken.
GDG 12 28 th October 2013	Did not attend.	No action taken.

B.2 Declarations of interests of the Expert Advisers

Brian Pullen, Locality Manager, Welsh Ambulance Services NHS Trust and Dr Tsz-Yan Milly Lo, Consultant in Paediatric Intensive Care Medicine, Royal Hospital for Sick Children had no declarations of interest.

Appendix C: Scope

C.1 NATIONAL INSTITUTE FOR HEALTH AND CARE EXCELLENCE

SCOPE

C.1.1 Guideline title

Triage, assessment, investigation and early management of head injury in children, young people and adults.

C.1.1.1 Short title

Head injury.

C.1.2 The remit

This is a partial update of 'Head injury' (NICE clinical guideline 56). See section A.1.4.3 for details of which sections will be updated. We will also carry out an editorial review of all recommendations to ensure that they comply with NICE's duties under equalities legislation.

This update is being undertaken as part of the guideline review cycle.

C.1.3 Clinical need for the guideline

C.1.3.1 Epidemiology

a) 'Head injury' for the purposes of the guideline is defined as any trauma to the head, other than superficial injuries to the face.

b) Each year 1.4 million people attend hospitals in England and Wales with a recent head injury. Between 33 and 50% of these are children under 15 years of age. The majority, around 80%, are diagnosed with 'mild' head injury and do not require hospital admission.

c) Annually, around 200,000 people are admitted to hospital with head injury. Of these, one fifth have features suggesting that their injury may have been sufficient to cause a skull fracture, or have evidence of brain damage. Approximately 2% of children with head injuries and 7% of adults with head injuries experience impaired consciousness and around 4000 patients a year undergo a neurosurgical operation for an intracranial complication. Most patients recover without specific or specialist intervention but in others, long-term disability or even death result from the effects of complications, which can potentially be minimised or avoided with early detection and appropriate treatment.

C.1.3.2 Current practice

a) Hospital Episode Statistics data for the 2010/2011 annual dataset indicate that 461 patients in England underwent an operation to drain the extradural space (OPCS code A40) and 3481 patients underwent an operation to drain the subdural space (OPCS code A41). These figures do not include a small number of other neurosurgical procedures possible after head injury, and include some patients with a non-head-injury diagnosis.

b) Although the incidence of head injury is high, the incidence of death from head injury is low (6-10 per 100,000 population per annum). As few as 0.2% of all patients attending emergency departments

with a head injury will die as a result of this injury. Ninety five per cent of all people who have sustained a head injury will present with a minor or mild injury (Glasgow Coma Scale [GCS] greater than 12) but the majority of fatal outcomes will be in the moderate (GCS of 9 to 12) or severe (GCS less than or equal to 8) head injury groups which account for only 5% of attenders. Therefore emergency departments see a large number of patients with a minor or mild head injury, and need to identify the very small number of these that will go on to have serious acute intracranial complications.

c) The previous head injury guidelines produced by NICE in 2003 and updated in 2007 resulted in computed tomography (CT) scanning replacing skull radiography as the primary imaging modality for assessment of head injury, and an increasing proportion of people with head injury whose care is managed in specialist centres. This has been associated with a decline in fatality in severe head injury patients.

d) Much of the remaining controversy and uncertainty in the early care of people with head injury is focused upon how certain groups of patients, such as those on anticoagulants and those with a significant but non-surgical traumatic brain injury, are best managed within the evolving NHS trauma systems.

C.1.4 The guideline

C.1.4.1 Population

Groups that will be covered

a) All adults, young people and children (including those aged 15 and under and infants under 1 year) who present with a suspected or confirmed head injury with or without other major trauma.

b) Patients with a suspected or confirmed head injury who may be unaware that they have sustained a head injury and may be overlooked, for example because of intoxication or vulnerable groups with cognitive impairment.

Groups that will not be covered

a) People with other traumatic injury to the head that are outside of the current definition of head injury in section A.1.3, including people with superficial injuries to the eye or face.

C.1.4.2 Healthcare settings

a) Primary care, pre-hospital, in emergency departments (or similar units), tertiary care, existing inpatients or those in residential care homes where NHS care is delivered.

C.1.4.3 Management

Key issues that will be covered

Pre-hospital assessment, advice and referral to hospital:

a) Selection of patients with head injury, with or without cervical spine injury, for specialist neuroscience care using clinical decision rules.

Assessment in the emergency department:

b) Selection of patients with head injury for imaging:

- with or without cervical spine injury using clinical decision rules.

- who have no history of amnesia or loss of consciousness who are on anticoagulant or anti-platelet therapy.
- using diagnostic circulating biomarkers (S100b, NSE and GFAP).

c) Diagnosis of cervical spine injury in patients with head injury, using computed tomography (CT) and magnetic resonance imaging (MRI) scans.

Discharge and follow-up

d) Information for patients and carers on discharge from the emergency department or observation ward.

Key issues that will not be covered

- a) Rehabilitation or long-term care of patients with a head injury.
- b) Areas addressed in the 2007 guideline that will not be reviewed:
 - Pre-hospital assessment, advice and referral to hospital (excluding issues in A.1.4.3 a)
 - Immediate management at the scene and transport to hospital
 - Involvement of the neurosurgical department (excluding issues in A.1.4.3 b)
 - Discharge and follow-up (excluding issues in A.1.4.3 d)
 - Admission and observation
 - Medical radiation

C.1.4.4 Main outcomes

- a) Diagnostic accuracy
- b) Case fatality at 30 days
- c) All-cause mortality at 30 days
- d) Objective measures of disability (including Glasgow Outcome Scale, King's Outcome Scale for Childhood Head Injury and Cerebral Performance Category scale)
- e) Quality of life (validated quality-of-life scores only)
- f) Length of hospital stay

C.1.4.5 Economic aspects

Developers will take into account both clinical and cost-effectiveness when making recommendations involving a choice between alternative interventions. A review of the economic evidence will be conducted and analyses will be carried out as appropriate. The preferred unit of effectiveness is the quality-adjusted life year (QALY), and the costs considered will usually be only from an NHS and personal social services (PSS) perspective. Further detail on the methods can be found in 'The guidelines manual' (see 'Further information').

C.1.4.6 Status

Scope

This is the final scope.

Timings

The development of the guideline recommendations will begin in May 2012.

C.1.5 Related NICE guidance

C.1.5.1 Published guidance

NICE guidance to be updated

This guideline will update and replace the following NICE guidance: Head Injury. NICE clinical guideline 56 (2007).

Other related NICE guidance

- Patient experience in adult NHS services. NICE clinical guideline 138 (2012)
- The epilepsies: the diagnosis and management of the epilepsies in adults and children in primary and secondary care. NICE clinical guideline 137 (2012).
- Alcohol-use disorders: diagnosis, assessment and management of harmful drinking and alcohol dependence. NICE clinical guideline 115 (2011).
- Service user experience in adult mental health. NICE clinical guideline 136 (2011).
- Delirium: diagnosis, prevention and management. NICE clinical guideline 103 (2010).
- Transient loss of consciousness in adults and young people. NICE clinical guideline 109 (2010).
- Sedation in children and young people: Sedation for diagnostic and therapeutic procedures in children and young people. NICE clinical guideline 112 (2010).
- Strategies to prevent unintentional injuries among children and young people aged under 15. NICE public health guidance 29 (2010).
- When to suspect child maltreatment. NICE clinical guideline 89 (2009).
- Medicines adherence. NICE clinical guideline 76 (2009).
- Acutely ill patients in hospital. NICE clinical guideline 50 (2007).
- Dementia: Supporting people with dementia and their carers in health and social care. NICE clinical guideline 42 (2006).
- Post-traumatic stress disorder (PTSD): The management of PTSD in adults and children in primary and secondary care. NICE clinical guideline 26 (2005).
- Falls: The assessment and prevention of falls in older people. NICE clinical guideline 21 (2004).
- Pre-hospital initiation of fluid replacement therapy in trauma. NICE technology appraisal guidance 74 (2004).

C.1.5.2 Guidance under development

- NICE is currently developing the following related guidance (details available from the NICE website): Intravenous fluid therapy in hospitalised adult patients. Publication date to be confirmed.

C.1.6 Further information

Information on the guideline development process is provided in:

- 'How NICE clinical guidelines are developed: an overview for stakeholders the public and the NHS'
- 'The guidelines manual'.

Information on the progress of the guideline will also be available from the NICE website.

Appendix D: Review protocols

D.1 Clinical

Table 1: Direct transport to specialist neuroscience care

Review question	What is the effectiveness of pre-hospital assessment tools for selecting adults, infants and children with head injury, for transport direct to specialist neuroscience care or a major trauma centre with neuroscience if the nearest hospital does not provide these?
Objectives	To identify where to transport patients with head injury
Criteria for considering studies in the review	
Study design	Randomised controlled trials Diagnostic cohort studies (prospective and retrospective) Systematic reviews and meta-analyses of the above
Population	Infants, children and adult with suspected head injury
Intervention	Clinical decision rules or triage tools for direct transport to neuroscience centre or major trauma centre with neuroscience. (for children - also able to deal with children) Review children separately if possible
Comparison	Nearest emergency department (if nearest hospital is not an MTC with neuroscience care) – with option for secondary transfer
Outcomes	Diagnostic accuracy of traumatic brain injury – any – confirmed on CT Diagnostic accuracy of traumatic brain injury – requiring neurosurgical intervention
Setting	Pre-hospital assessment by paramedics Unlikely to be self referral or GP referral.
Equalities	Different cultures may present differently. Non-English language Non-accidental injuries older people
Search Strategy	Databases: Medline, Embase, Cochrane Library Language: Restrict to English only Date restriction: none
Review Strategy	Population size and directness: No limitations on sample size Studies examining general trauma triage tools or decision rules will be used as indirect evidence provided they report data relating to head injury patients. Appraisal of methodological quality: The methodological quality of each study will be assessed using NICE checklists and GRADE. Meta-analysis will be conducted if appropriate. If not appropriate, ranges of results will be reported for these outcomes. Stratify by age: Infants and children (15 and under) Adult Subgroups: Time to destination for example cut off of 17 minutes Seniority of staff making the decision on where to transfer ABC status

Review question	What is the effectiveness of pre-hospital assessment tools for selecting adults, infants and children with head injury, for transport direct to specialist neuroscience care or a major trauma centre with neuroscience if the nearest hospital does not provide these?
	Neuroscience care (major trauma centre or specialist neuroscience centre)

Table 2: Clinical decision rules for imaging the head

	Review protocol
Review question	What is the best clinical decision rule for selecting adults, infants and children with head injury for CT head scan?
Objectives	To determine which patients should receive imaging of the head The key clinical issue is to have a decision rule which is as sensitive and specific as possible in order to minimise the number of false negatives which can have catastrophic consequences.
Criteria for considering studies in the review	
Study design	Randomised controlled trials Diagnostic cohorts (prospective and retrospective) Systematic reviews and meta-analyses of the above
Population	Infants, children and adult with suspected head injury
Index test	Validated clinical decision rules including NEXUS, NOC, CHR, Canadian CT-rules, New Orleans criteria or CHALICE. Noted that separate decision rules exist for children and adults. Validated clinical decision rules for adults All clinical decision rules for children New/additional decision rules: post traumatic amnesia (also an outcome), updated Canadian CT rules, updated CHALICE, CATCH, PECARN,
Comparison	As above – compared to each other.
Reference standard	CT or negative follow up (1 month for adults, 2 weeks for children).
Outcomes	Diagnostic accuracy of need for neurosurgical intervention Diagnostic accuracy of any intracranial abnormality
Setting	Assessment in the emergency department
Equalities	Different cultures may present differently. Non-English language Non-accidental injuries Older people
Search Strategy	Databases: Medline, Embase, Cochrane Library Language: Restrict to English only Date restriction: Restrict search from 2006
Review Strategy	Population size and directness: No limitations on sample size Studies with indirect populations will not be considered Appraisal of methodological quality: The methodological quality of each study will be assessed using NICE checklists and GRADE. Meta-analysis will be conducted if appropriate. If not appropriate, ranges of results will be reported for these outcomes. Stratify by age: Infants and children (15 and under) Adult

	Review protocol
	Subgroups: People with delayed presentation of head injury. People who have had a seizure.

Table 3: Anticoagulants

	Review protocol
Review question	What is the best clinical decision rule for selecting adults, infants and children with head injury for CT head scan who have no history of amnesia or loss of consciousness who are on anticoagulant or antiplatelet therapy?
Objectives	To determine which patients with no history of amnesia or loss of consciousness who are on anticoagulant or antiplatelet therapy should receive a CT scan
Criteria for considering studies in the review	
Study design	Randomised controlled trials Diagnostic cohort studies (prospective or retrospective) Prospective observational studies Systematic reviews and meta-analyses of the above
Population	Noted that main population likely to be over 65 Infants, children and adult with head injury Anticoagulated patients (for example warfarin, unfractionated heparin, low molecular weight heparin) Patients receiving antiplatelet therapy (for example aspirin, clopidogrel)
Index test	Clinical decision rules for the selection of patients for imaging compared to each other.
Reference standard	CT for intracranial bleeding or negative 7 day follow up
Outcomes	Diagnostic accuracy of need for neurosurgical intervention Diagnostic accuracy of any intracranial abnormality
Setting	Assessment in the emergency department
Equalities	Different cultures may present differently. Non-English language Non-accidental injuries Older people
Search Strategy	Databases: Medline, Embase, the Cochrane Library Language: Restrict to English only Date restriction: No date restriction
Review Strategy	Population size and directness: No limitations on sample size Studies with indirect populations will not be considered Appraisal of methodological quality: The methodological quality of each study will be assessed using NICE checklists and GRADE. Meta-analysis will be conducted if appropriate. If not appropriate, ranges of results will be reported for these outcomes. Stratify by age: Infants and children (15 and under) Adult

	Review protocol
	Subgroups: Older people (over 65) Antiplatelet, anticoagulant

Table 4: Biomarkers

Review question	What is the diagnostic accuracy of biomarkers (S100b, NSE, GFAP) in the emergency department for selecting adults, infants and children with head injury for
Objectives	To determine the value of using biomarkers as a diagnostic tool for ruling out intracranial bleeds in adults, children and infants with head injury.
Criteria for considering studies in the review	
Study design	Randomised controlled trials Diagnostic cohort studies (prospective or retrospective). Systematic reviews and meta-analyses of the above
Population	Adults with head injury and/or suspected cervical spine injury
Index test	Biomarkers: S100b, NSE, GFAP (to be reviewed as single interventions, combinations will not be reviewed due to limited reviewing resource) Diagnostic threshold and timing of use of biomarker as per manufacturers instructions. Exclude studies where the interval between injury and blood sampling is over 6 hours.
Reference standard	CT or negative follow up (1 month for adults, 2 weeks for children).
Outcomes	Diagnostic accuracy of any intracranial abnormality Diagnostic accuracy of need for neurosurgical intervention
Setting	Assessment in the emergency department
Equalities	None noted
Search Strategy	Databases: Medline, Embase, the Cochrane Library Language: Restrict to English only Date restriction: No date restriction
Review Strategy	Population size and directness: No limitations on sample size Studies with indirect populations will not be considered Appraisal of methodological quality: The methodological quality of each study will be assessed using NICE checklists and GRADE. Meta-analysis will be conducted if appropriate. If not appropriate, ranges of results will be reported for these outcomes. Stratify by age: Children Adults Subgroups: Older people (over 65)

Table 5: Clinical decision rules for cervical spine imaging

	Review protocol
Review question	What is the best clinical decision rule for selecting adults, infants and children with head injury for initial imaging with plain X-rays or CT scan for cervical spine injury?
Objectives	To determine which patients presenting with head injury should receive imaging of the head/and or cervical spine
<u>Criteria for considering studies in the review</u>	
Study design	Randomised controlled trials Diagnostic cohort studies (prospective or retrospective) Prospective observational studies (if no data from decision rules identified) Systematic reviews and meta-analyses of the above
Population	Infants, children and adult with suspected head injury, with suspected cervical spine injury
Index test	Validated clinical decision rules including NEXUS, NOC, CCR. Noted that separate decision rules exist for children and adults. Validated clinical decision rules for adults and either validated rules or derivation of new rules in children and infants.
Reference standard	X-ray, CT, or follow up (48 hours minimum) for people with no initial imaging
Outcomes	Diagnostic accuracy any significant cervical spine injury (fracture/bony injury or soft tissue/ligament damage) Diagnostic accuracy of need for neurological intervention/spinal surgery
Setting	Assessment in the emergency department
Equalities	Different cultures may present differently. Non-English language Non-accidental injuries Older people
Search Strategy	Databases: Medline, Embase, Cochrane Library Language: Restrict to English only Date restriction: Restrict search from 2006
Review Strategy	Population size and directness: <ul style="list-style-type: none"> No limitations on sample size Studies with indirect populations will not be considered Appraisal of methodological quality: <ul style="list-style-type: none"> The methodological quality of each study will be assessed using NICE checklists and GRADE. Meta-analysis will be conducted if appropriate. If not appropriate, ranges of results will be reported for these outcomes. Stratify by age: <ul style="list-style-type: none"> Infants and children (15 and under) Adult Subgroups: Bone injury Soft tissue injury

	Review protocol
Review question	What is the best clinical decision rule for selecting adults, infants and children with head injury, who have received a negative or indeterminate X-ray of the cervical spine, for further imaging with CT or MRI scan for cervical spine injury?
Objectives	To determine which patients should receive further imaging of their cervical spine, after receiving a negative or indeterminate X-ray where there is still a clinical suspicion on cervical injury.
<u>Criteria for considering studies in the review</u>	
Study design	Randomised controlled trials Diagnostic cohort studies (prospective or retrospective) Prospective observational studies (if no data from decision rules identified) Systematic reviews and meta-analyses of the above
Population	Infants, children and adult with suspected head injury, with suspected cervical spine injury
Index test	Validated clinical decision rules including NEXUS, NOC, CCR. Noted that separate decision rules exist for children and adults. Validated clinical decision rules for adults either validated rules or derivation of new rules in children and infants.
Reference standard	CT, or MRI or follow up (48 hours minimum).
Outcomes	Diagnostic accuracy any significant cervical spine injury (fracture bony injury or soft tissue/ligament damage) Diagnostic accuracy of need for neurological intervention/spinal surgery
Setting	Assessment in the emergency department
Equalities	Different cultures may present differently. Non-English language Non-accidental injuries Older people
Search Strategy	Databases: Medline, Embase, Cochrane Library Language: Restrict to English only Date restriction: Restrict search from 2006 (if prospective observational studies are required due to no RCT or diagnostic cohort data, not date restriction will be applied).
Review Strategy	Population size and directness: <ul style="list-style-type: none"> No limitations on sample size Studies with indirect populations will not be considered Appraisal of methodological quality: <ul style="list-style-type: none"> The methodological quality of each study will be assessed using NICE checklists and GRADE. Meta-analysis will be conducted if appropriate. If not appropriate, ranges of results will be reported for these outcomes. Stratify by age: <ul style="list-style-type: none"> Infants and children (15 and under) Adult Subgroups: Bone injury Soft tissue injury

	Review protocol
Review question	What is the best clinical decision rule for selecting adults, infants and children with head injury, who have received a negative or indeterminate CT cervical spine scan, for further imaging with MRI scan for cervical spine injury?
Objectives	To determine which patients should receive imaging of cervical spine after receiving an initial negative or indeterminate CT, but there is still a clinical suspicion on cervical injury.
<u>Criteria for considering studies in the review</u>	
Study design	Randomised controlled trials Diagnostic cohort studies (prospective or retrospective) Prospective observational studies (if no data from decision rules identified) Systematic reviews and meta-analyses of the above
Population	Infants, children and adult with suspected head injury, with suspected cervical spine injury
Index test	Validated clinical decision rules including NEXUS, NOC, CCR. Noted that separate decision rules exist for children and adults. Validated clinical decision rules for adults either validated rules or derivation of new rules in children and infants.
Reference standard	MRI, or follow up (48 hours minimum).
Outcomes	Diagnostic accuracy any significant cervical spine injury (fracture/bony injury or soft tissue/ligament damage) Diagnostic accuracy of need for neurological intervention/spinal surgery
Setting	Assessment in the emergency department
Equalities	Different cultures may present differently. Non-English language Non-accidental injuries Older people
Search Strategy	Databases: Medline, Embase, Cochrane Library Language: Restrict to English only Date restriction: Restrict search from 2006 (if prospective observational studies are required due to no RCT or diagnostic cohort data, not date restriction will be applied).
Review Strategy	Population size and directness: <ul style="list-style-type: none"> No limitations on sample size Studies with indirect populations will not be considered Appraisal of methodological quality: <ul style="list-style-type: none"> The methodological quality of each study will be assessed using NICE checklists and GRADE. Meta-analysis will be conducted if appropriate. If not appropriate, ranges of results will be reported for these outcomes. Stratify by age: <ul style="list-style-type: none"> Infants and children (15 and under) Adult Subgroups: Bone injury Soft tissue injury

Table 6: Patient information and support on discharge advice

Review question	What information and support do patients with head injury say they want? What discharge information should be given to patients with head injury?
Objectives	To determine what information should be provided to patients with head injury.
Criteria for considering studies in the review	
Study design	Qualitative literature Surveys Evidence may also be drawn from other reviews in the guideline.
Population	Infants, children and adult with head injury with or without cervical spine injury Discharge advice for those admitted and those not admitted.
Intervention	Particular advice to address: People discharged from emergency department who were not admitted to hospital People discharged from emergency department who were admitted for observation Advice by age: Infants and children (15 and under) and adults. Discharge advice for return to activity of daily living; including work, school, driving and sport People with head injury using anticoagulation treatment People with cognitive impairment information for carers and family along with information from patients. Age and communication with younger children/verbal ability (some children can tell you how they feel and others can't). Older patients returning to care homes/nursing homes and what information is specifically needed.
Comparison	Not applicable
Outcomes	Not predefined
Setting	Emergency department
Equalities	As highlighted in the studies.
Search Strategy	Databases: Medline, Embase, Cinahl Language: Restrict to English only
Review Strategy	Population size and directness: No limitations on sample size Studies with indirect populations will not be considered Appraisal of methodological quality: The methodological quality of each study will be assessed using NICE checklists. Stratify by age: Not applicable Subgroups: None

D.2 Economic

Table 7: Appended economic review protocol

Review question	All questions – health economic evidence
Objectives	To identify economic studies relevant to the review questions set out above.
Criteria	Populations, interventions and comparators as specified in the individual review protocols above. Must be a relevant economic study design (cost-utility analysis, cost-benefit analysis, cost-effectiveness analysis, cost-consequence analysis, comparative cost analysis).
Search strategy	An economic study search was undertaken using population specific terms and an economic study filter – see Appendix G.
Review strategy	<p>Each study is assessed using the NICE economic evaluation checklist – NICE (2012) Guidelines Manual.</p> <p>Inclusion/exclusion criteria</p> <p>If a study is rated as both ‘Directly applicable’ and ‘Minor limitations’ (using the NICE economic evaluation checklist) then it should be included in the guideline. An evidence table should be completed and it should be included in the economic profile.</p> <p>If a study is rated as either ‘Not applicable’ or ‘Very serious limitations’ then it should be excluded from the guideline. It should not be included in the economic profile and there is no need to include an evidence table.</p> <p>If a study is rated as ‘Partially applicable’ and/or ‘Potentially serious limitations’ then there is discretion over whether it should be included. The health economist should make a decision based on the relative applicability and quality of the available evidence for that question, in discussion with the GDG if required. The ultimate aim being to include studies that are helpful for decision making in the context of the guideline and current NHS setting. Where exclusions occur on this basis, this should be noted in the relevant section of the guideline with references.</p> <p>Also exclude:</p> <ul style="list-style-type: none"> unpublished reports unless submitted as part of a call for evidence abstract-only studies letters editorials reviews of economic evaluations foreign language articles <p>Where there is discretion</p> <p>The health economist should be guided by the following hierarchies.</p> <p>Setting:</p> <ul style="list-style-type: none"> UK NHS OECD countries with predominantly public health insurance systems (for example France, Germany, Sweden) OECD countries with predominantly private health insurance systems (for example USA, Switzerland) Non-OECD settings (always ‘Not applicable’) <p>Economic study type:</p> <ul style="list-style-type: none"> Cost-utility analysis Other type of full economic evaluation (cost-benefit analysis, cost-effectiveness analysis, cost-consequence analysis) Comparative cost analysis Non-comparative cost analyses including cost of illness studies (always ‘Not applicable’)

Review question	All questions – health economic evidence
	Year of analysis: The more recent the study, the more applicable it is Quality and relevance of effectiveness data used in the economic analysis: The more closely the effectiveness data used in the economic analysis matches with the studies included for the clinical review the more useful the analysis will be to decision making for the guideline.

(a) Recent reviews will be ordered although not reviewed. The bibliographies will be checked for relevant studies, which will then be ordered.

Appendix E: Clinical article selection

Figure 1: Flow diagram of article selection for the direct transport to neuroscience review

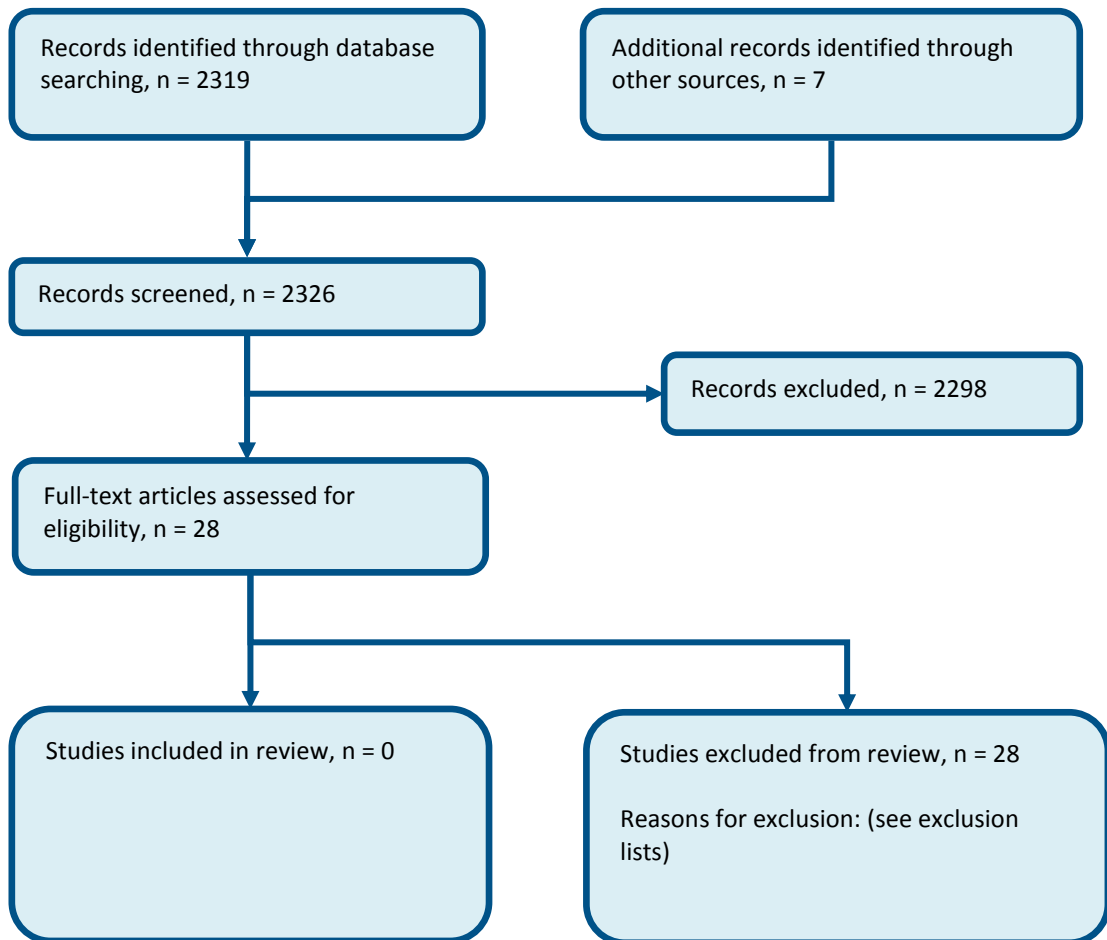

Figure 1: Flow diagram of clinical article selection for clinical decision rules for head CT imaging review

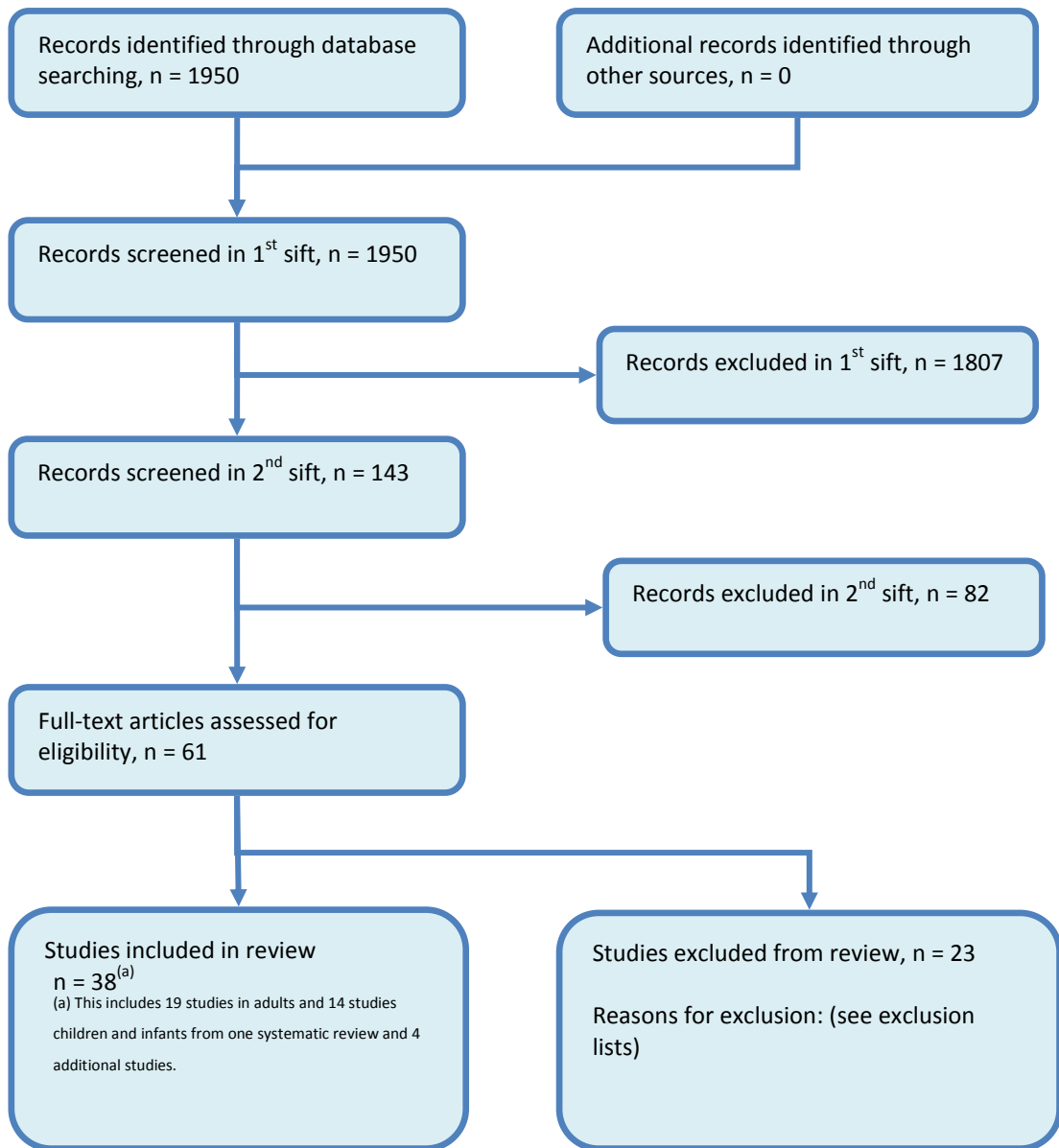

Table 8: Flow diagram of clinical article selection for anticoagulants

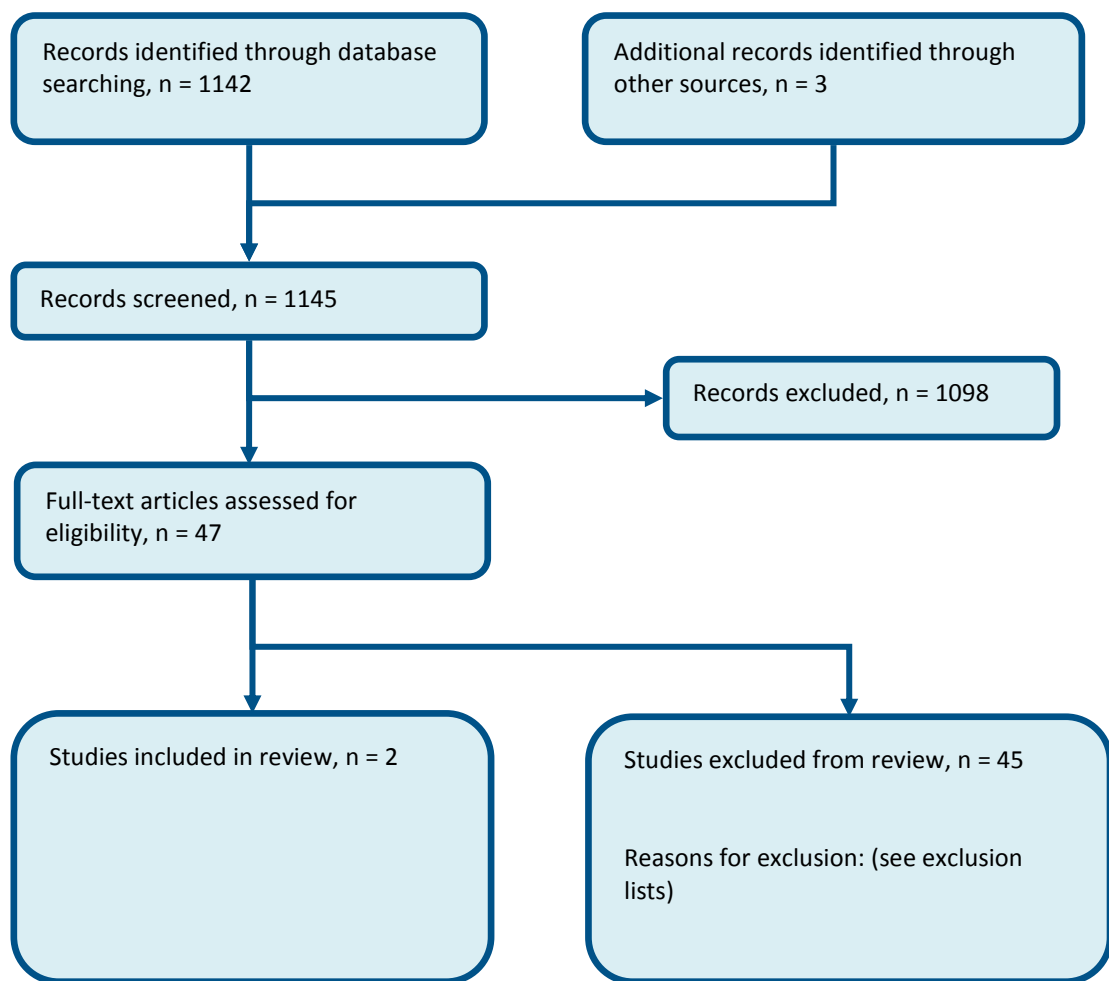

Table 9: Flow diagram of clinical article selection for biomarkers

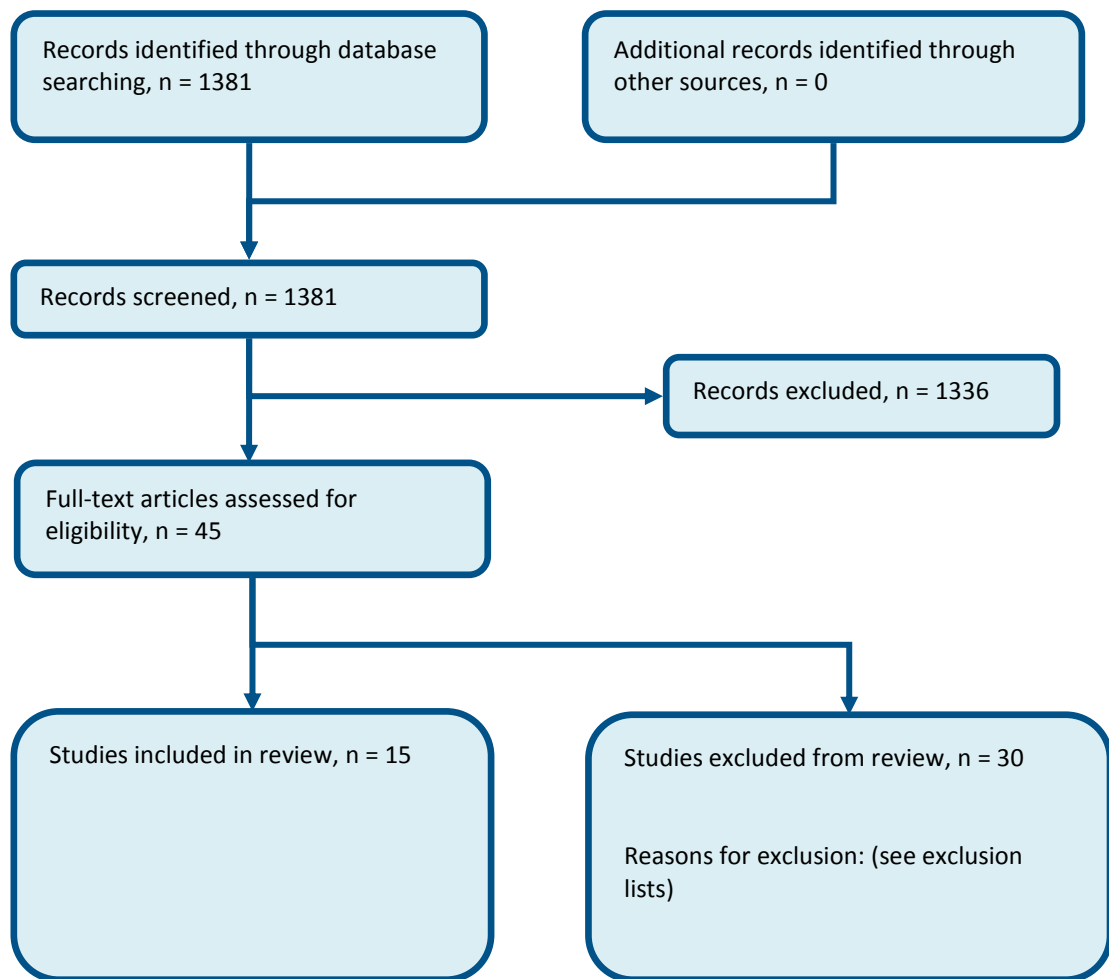

Table 10: Flow diagram of clinical article selection for cervical spine imaging

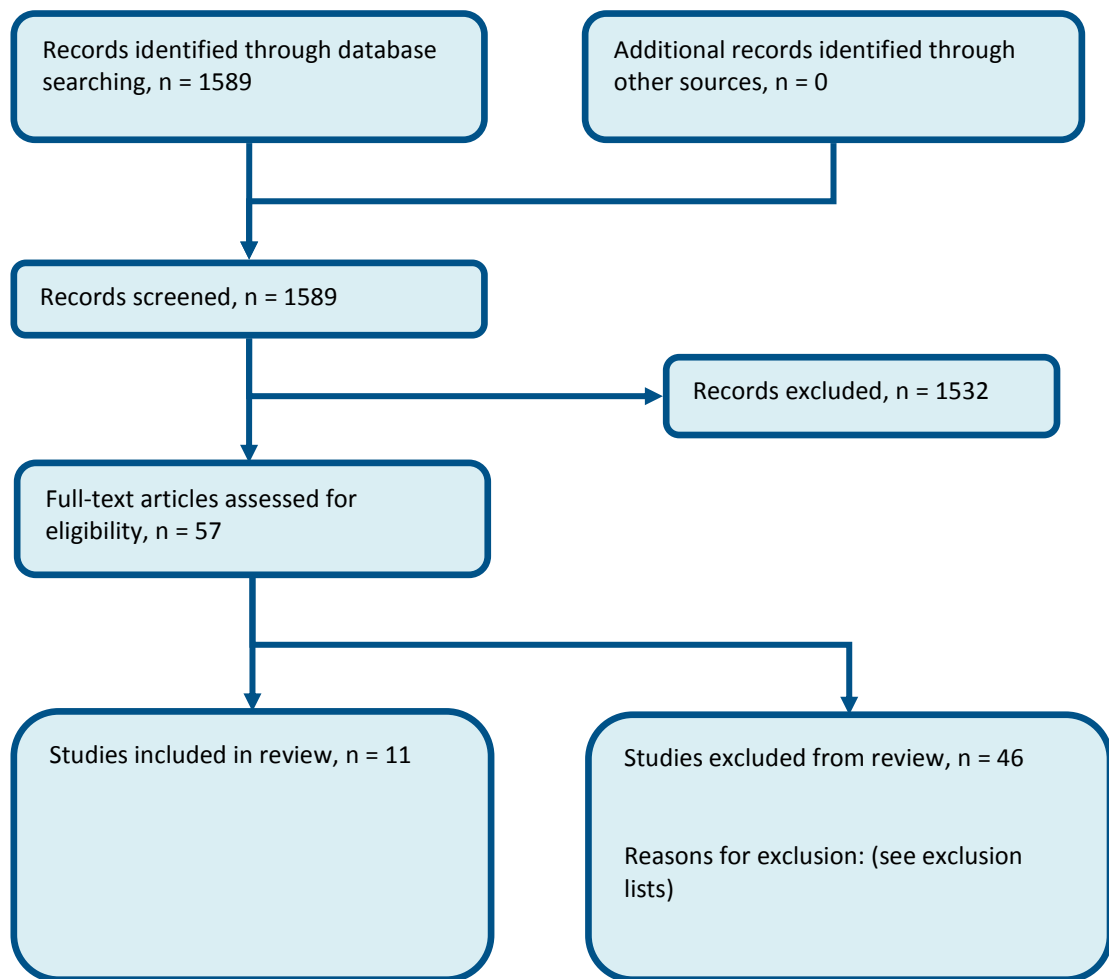
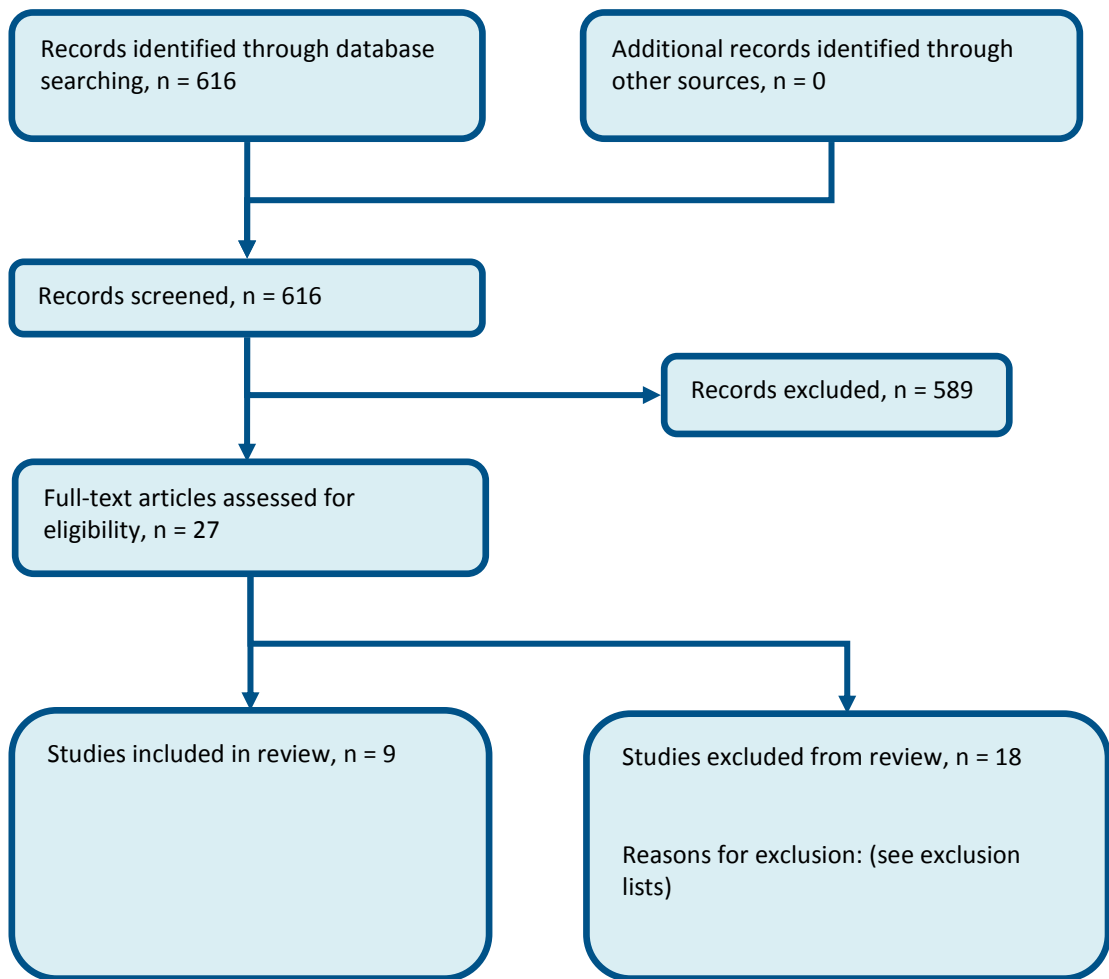
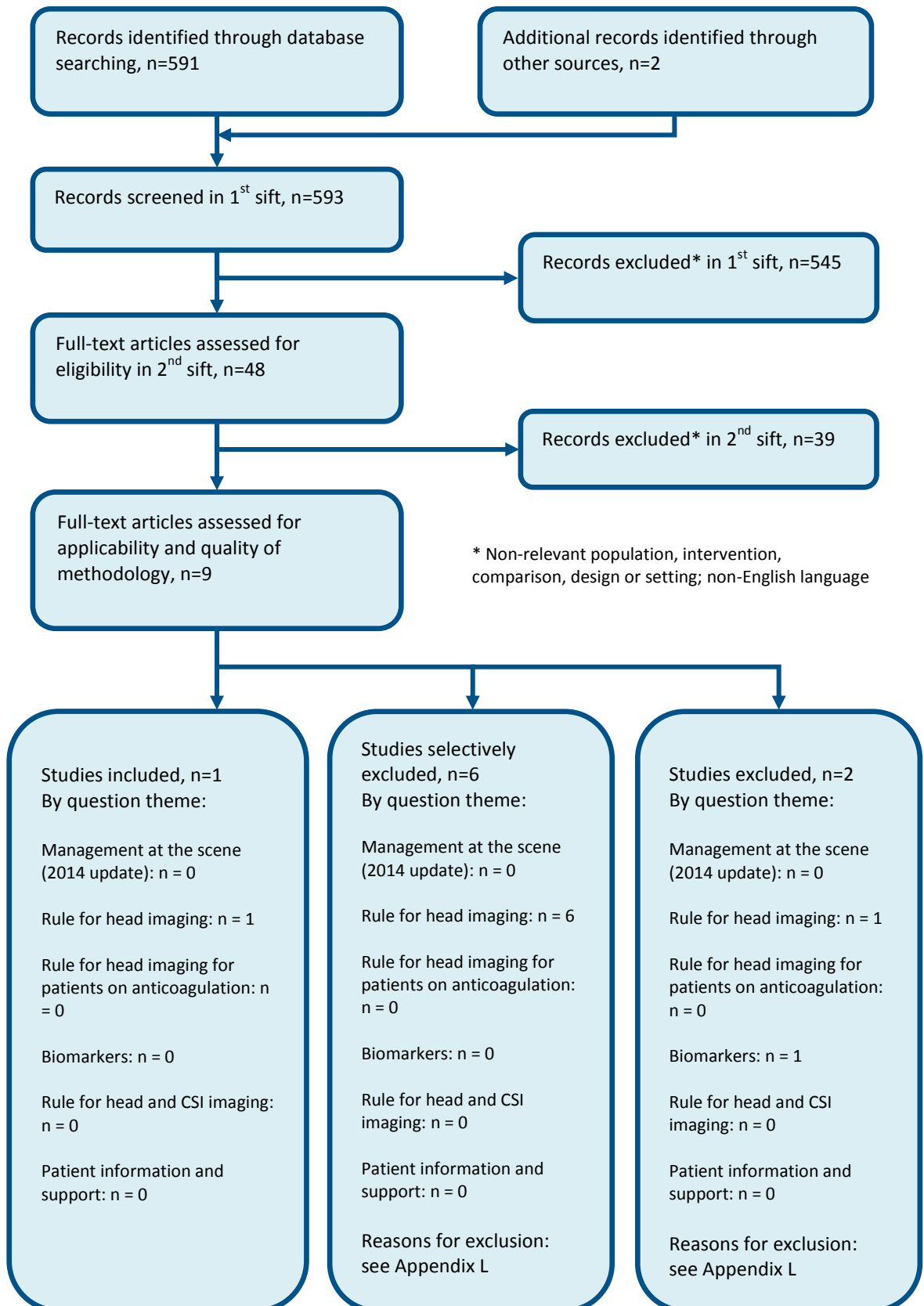

Table 11: Flow diagram of clinical article selection for patient information and discharge



Appendix F: Economic article selection

Figure 2: Flow diagram of clinical article selection for guideline



Appendix G: Literature search strategies

Search strategies used for the Head Injury guideline are outlined below and were run in accordance with the methodology in the NICE Guidelines Manual 2009.^{345,345}

All searches were run up to **31 May 2013** unless otherwise stated. Any studies added to the databases after this date were not included unless specifically stated in the text. Where possible searches were limited to retrieve material published in English. Searches to update questions covered in the previous NICE guidance on Head injury (reference) were limited to retrieve material published since the date of the original searches for that guideline. The date limitations for each search are indicated with the searches below. In summary, for new questions databases were searched for all years covered; for questions last updated in the 2007 version of the guideline databases were searched from 2006 onwards; and for patient information, where the review was not updated for the 2007 version of the guideline databases were searched from 2003 onwards.

Searches for the **clinical reviews** were run in Medline (OVID), Embase (OVID) and the Cochrane Library (Wiley except for questions which solely considered observational studies where the Cochrane Library was omitted). Usually, searches were constructed in the following way:

- A PICO format was used for **intervention** searches where population (P) terms were combined with Intervention (I) and sometimes Comparison (C) terms. An intervention can be a drug, a procedure or a diagnostic test. Outcomes (O) are rarely used in search strategies for interventions. Search Filters were also added to the search where appropriate.
- A PEO format was used for **prognosis** searches where population (P) terms were combined with exposure (E) terms and sometimes outcomes (O). Search filters were added to the search where appropriate.

Searches for **patient views** were run in Medline (Ovid), Embase (Ovid) and Cinahl (EBSCO). Searches were constructed by adding a patient views search filter to the population terms.

Searches for the **health economic reviews** were run in Medline (OVID), Embase (OVID), the NHS Economic Evaluations Database (NHS EED), the Health Technology Assessment (HTA) database and the Health Economic Evaluation Database (HEED). Searches in NHS EED and HEED were constructed only using population terms. For Medline and Embase an economic filter (instead of a study design filter) was added to the same clinical search strategy.

Searches for **quality of life** data were run in Medline (OVID) and Embase (OVID) by adding the filter in to the two searches for which data were required: anticoagulants and cervical spine imaging.

All searches in Medline and Embase had a filter added to exclude animal studies and papers relating to comments, letters and editorials.

All searches were limited to English only studies.

G.1 Population search strategies

G.1.1 Head injury population

This population was used in all questions except for part of the cervical spine search

Medline search terms

1.	craniocerebral trauma/ or exp brain injuries/ or coma, post-head injury/ or exp head injuries, closed/ or head injuries, penetrating/ or exp intracranial hemorrhage, traumatic/ or exp skull fractures/
2.	((head or brain) adj3 (injur* or trauma)).ti,ab.
3.	(skull adj3 fracture*).ti,ab.
4.	or/1-4

Embase search terms

1.	head injury/
2.	exp brain injury/ or traumatic brain injury/
3.	((head or brain) adj3 (injur* or trauma)).ti,ab.
4.	skull injury/ or exp skull fracture/
5.	(skull adj3 fracture*).ti,ab.
6.	or/1-5

Cochrane search terms

#1.	MeSH descriptor: [Craniocerebral Trauma] this term only
#2.	MeSH descriptor: [Brain Injuries] explode all trees
#3.	MeSH descriptor: [Coma, Post-Head Injury] explode all trees
#4.	MeSH descriptor: [Head Injuries, Closed] explode all trees
#5.	MeSH descriptor: [Head Injuries, Penetrating] explode all trees
#6.	MeSH descriptor: [Intracranial Hemorrhage, Traumatic] explode all trees
#7.	MeSH descriptor: [Skull Fractures] explode all trees
#8.	((head or brain) near/3 (injur* or trauma)):ti,ab
#9.	(skull near/3 fracture*):ti,ab
#10.	((cerebral or craniocerebral) next trauma):ti,ab
#11.	#1 or #2 or #3 or #4 or #5 or #6 or #7 or #8 or #9 or #10

Cinahl search terms

S1.	(MH "Head Injuries+")
S2.	TX ((head or brain) N3 (injur* or trauma))
S3.	TX (skull N3 fracture*)
S4.	TX S1 or S2 or S3

G.1.2 General trauma population

This search line was added to the head injury population for the direct transport question only.

Medline search terms

1.	(trauma or (traumatic adj3 injur*)).mp.
----	---

Embase search terms

1.	(trauma or (traumatic adj3 injur*)).mp.
----	---

Cochrane search terms

#1.	trauma or (traumatic near/3 injur*)
-----	-------------------------------------

G.1.3 Cervical spine injury population

This population was used for the question relating to imaging of the cervical spine only.

Medline search terms

1.	exp Spinal Injuries/
2.	Spinal Cord Injuries/
3.	exp Neck Injuries/
4.	whiplash.ti,ab.
5.	((neck or spine or spinal) adj3 (trauma or injur*)).ti,ab.
6.	or/1-5
7.	cervical.ti,ab.
8.	6 and 7

Embase search terms

1.	spine injury/ or cervical spine injury/
2.	spinal cord injury/ or cervical spinal cord injury/
3.	neck injury/ or whiplash injury/
4.	whiplash.ti,ab.
5.	((neck or spine or spinal) adj3 (trauma or injur*)).ti,ab.
6.	or/1-5
7.	cervical.ti,ab.
8.	6 and 7

Cochrane search terms

#1.	MeSH descriptor Spinal Injuries explode all trees
#2.	MeSH descriptor Spinal Cord Injuries, this term only
#3.	MeSH descriptor Neck Injuries explode all trees
#4.	whiplash:ti,ab
#5.	((neck or spine or spinal) near/3 (trauma or injur*)):ti,ab
#6.	(#1 or #2 or #3 or #4 or #5)

G.2 Study filter search terms

G.2.1 Excluded studies search terms

The following study designs and publication types were removed from retrieved results using the NOT operator.

Medline search terms

1.	letter/
2.	editorial/
3.	news/
4.	exp historical article/
5.	Anecdotes as Topic/
6.	comment/
7.	case report/
8.	(letter or comment*).ti.
9.	or/1-8
10.	randomized controlled trial/ or random*.ti,ab.
11.	9 not 10
12.	animals/ not humans/
13.	exp Animals, Laboratory/
14.	exp Animal Experimentation/
15.	exp Models, Animal/
16.	exp Rodentia/
17.	(rat or rats or mouse or mice).ti.
18.	or/11-17

Embase search terms

1.	letter.pt. or letter/
2.	note.pt.
3.	editorial.pt.
4.	case report/ or case study/
5.	(letter or comment*).ti.
6.	or/1-5
7.	randomized controlled trial/ or random*.ti,ab.
8.	6 not 7
9.	exp animal/ not human/
10.	nonhuman/
11.	exp experimental animal/
12.	exp animal experiment/
13.	exp animal model/
14.	exp Rodent/
15.	(rat or rats or mouse or mice).ti.
16.	or/8-15

G.2.2 Observational studies search terms

Medline search terms

1.	Epidemiologic studies/
2.	exp case control studies/
3.	exp cohort studies/
4.	Cross-sectional studies/
5.	case control.ti,ab.
6.	(cohort adj (study or studies or analys*)).ti,ab.
7.	((follow up or observational or uncontrolled or non randomi#ed) adj (study or studies)).ti,ab.
8.	((longitudinal or retrospective or prospective) and (study or studies or review or analys* or cohort*)).ti,ab.
9.	cross sectional.ti,ab.
10.	or/1-9

Embase search terms

1.	Clinical study/
2.	exp case control study/
3.	family study/
4.	longitudinal study/
5.	retrospective study/
6.	prospective study/
7.	cross-sectional study/
8.	cohort analysis/
9.	follow-up/
10.	cohort*.ti,ab.
11.	9 and 10
12.	case control.ti,ab.
13.	((follow up or observational or case control or uncontrolled or non randomi#ed or epidemiologic*) adj (study or studies)).ti,ab.
14.	((longitudinal or retrospective or prospective or cross sectional) adj3 (study or studies or review or analys* or cohort*)).ti,ab.
15.	(cohort adj (study or studies or analys*)).ti,ab.
16.	or/1-8,11-15

G.2.3 Patient views search terms

Medline search terms

1.	"patient acceptance of health care"/ or exp patient satisfaction/
2.	Patient Education as Topic/
3.	(information* adj3 (patient* or need* or requirement* or support* or seek* or access* or disseminat*)).ti,ab.
4.	((client* or patient* or user* or carer* or consumer* or customer*) adj2 (attitud* or priorit* or perception* or preferen* or expectation* or choice* or perspective* or view* or satisfact* or inform* or experience or experiences or opinion*)).ti,ab.
5.	Patient discharge/
6.	discharge*.ti,ab.
7.	or/1-7

Embase search terms

1.	patient attitude/ or patient preference/ or patient satisfaction/ or consumer attitude/
2.	patient information/ or consumer health information/
3.	patient education/
4.	(information* adj3 (patient* or need* or requirement* or support* or seek* or access* or disseminat*)).ti,ab.
5.	((client* or patient* or user* or carer* or consumer* or customer*) adj2 (attitud* or priorit* or perception* or preferen* or expectation* or choice* or perspective* or view* or satisfact* or inform* or experience or experiences or opinion*)).ti,ab.
6.	hospital discharge/
7.	discharge*.ti,ab.
8.	or/1-7

Cinahl search terms

S1.	(MH "Patient Satisfaction")
S2.	(MH "Consumer Attitudes") OR (MH "Patient Attitudes")
S3.	TX ((client* or patient* or user* or carer* or consumer* or customer*) n2 (attitud* or priorit* or perception* or preferen* or expectation* or choice* or perspective* or view* or satisfact* or inform* or experience or experiences or opinion*))
S4.	(MH "Patient Discharge") OR (MH "Patient Discharge Education")
S5.	(MH "Patient Education")
S6.	(MH "Health Information") OR (MH "Consumer Health Information")
S7.	TX information* n3 (patient* or need* or requirement* or support* or seek* or access* or disseminat*)
S8.	S1 or S2 or S3 or S4 or S5 or S6 or S7

G.2.4 Qualitative studies terms

Medline search terms

1.	qualitative research/
2.	exp Interviews as Topic/
3.	exp Questionnaires/
4.	health care surveys/
5.	(qualitative or interview* or focus group* or theme* or questionnaire* or survey*).ti,ab.
6.	or/1-5

Embase search terms

1.	qualitative research/
2.	exp interview/
3.	exp questionnaire/
4.	health care survey/
5.	(qualitative or interview* or focus group* or theme* or questionnaire* or survey*).ti,ab.
6.	or/1-5

Cinahl search terms

S1.	(MH "Qualitative Studies+")
S2.	(MH "Qualitative Validity+")
S3.	(MH "Focus Groups") OR (MH "Interviews+") OR (MH "Surveys")
S4.	(MH "Questionnaires+")

S5.	TX qualitative or interview* or focus group* or theme* or questionnaire* or survey*
S6.	S1 or S2 or S3 or S4 or S5

G.2.5 Prediction rules search terms

Medline search terms

1.	predict.ti.
2.	(validat* or rule*).ti,ab.
3.	(predict* and (outcome* or risk* or model*)).ti,ab.
4.	((history or variable* or criteria or scor* or characteristic* or finding* or factor*) and (predict* or model* or decision* or identif* or prognos*)).ti,ab.
5.	decision*.ti,ab. and Logistic models/
6.	(decision* and (model* or clinical*)).ti,ab.
7.	(prognostic and (history or variable\$ or criteria or scor* or characteristic* or finding* or factor* or model*)).ti,ab.
8.	(stratification or discrimination or discriminate or c statistic or "area under the curve" or AUC or calibration or indices or algorithm or multivariable).ti,ab.
9.	ROC curve/
10.	or/1-9

Embase search terms

1.	predict.ti.
2.	(validat* or rule*).ti,ab.
3.	(predict* and (outcome* or risk* or model*)).ti,ab.
4.	((history or variable* or criteria or scor* or characteristic* or finding* or factor*) and (predict* or model* or decision* or identif* or prognos*)).ti,ab.
5.	decision*.ti,ab. and Statistical model/
6.	(decision* and (model* or clinical*)).ti,ab.
7.	(prognostic and (history or variable* or criteria or scor* or characteristic* or finding* or factor* or model*)).ti,ab.
8.	(stratification or discrimination or discriminate or c statistic or "area under the curve" or AUC or calibration or indices or algorithm or multivariable).ti,ab.
9.	Receiver operating characteristic/
10.	or/1-9

G.2.6 Triage search terms

Medline search terms

1.	triage/
2.	triage.ti,ab.
3.	protocol.ti,ab.
4.	or/1-3

Embase search terms

1.	triage.mp.
2.	protocol.ti,ab.
3.	or/1-2

G.2.7 Health economics search terms

Medline search terms

1.	Economics/
2.	Value of life/
3.	exp "Costs and Cost Analysis"/
4.	exp Economics, Hospital/
5.	exp Economics, Medical/
6.	Economics, Nursing/
7.	Economics, Pharmaceutical/
8.	exp "Fees and Charges"/
9.	exp Budgets/
10.	budget*.ti,ab.
11.	cost*.ti.
12.	(economic* or pharmaco?economic*).ti.
13.	(price* or pricing*).ti,ab.
14.	(cost* adj2 (effective* or utilit* or benefit* or minimi* or unit* or estimat* or variable*)).ab.
15.	(financ* or fee or fees).ti,ab.
16.	(value adj2 (money or monetary)).ti,ab.
17.	exp models, economic/
18.	*Models, Theoretical/
19.	*Models, Organizational/
20.	markov chains/
21.	monte carlo method/
22.	exp Decision Theory/
23.	(markov* or monte carlo).ti,ab.
24.	econom* model*.ti,ab.
25.	(decision* adj2 (tree* or analy* or model*)).ti,ab.
26.	or/1-25

Embase search terms

1.	funding/
2.	budget*.ti,ab.
3.	cost*.ti.
4.	(economic* or pharmaco?economic*).ti.
5.	(price* or pricing*).ti,ab.
6.	(cost* adj2 (effective* or utilit* or benefit* or minimi* or unit* or estimat* or variable*)).ab.
7.	(financ* or fee or fees).ti,ab.
8.	(value adj2 (money or monetary)).ti,ab.
9.	statistical model/
10.	exp economic aspect/
11.	9 and 10
12.	*theoretical model/
13.	*nonbiological model/
14.	stochastic model/
15.	decision theory/

16.	decision tree/
17.	monte carlo method/
18.	(markov* or monte carlo).ti,ab.
19.	econom* model*.ti,ab.
20.	(decision* adj2 (tree* or analy* or model*)).ti,ab.
21.	or/1-8,11-20

G.2.8 Quality of life

Medline search terms

1.	"Value of Life"/
2.	quality adjusted life.tw.
3.	(qaly\$ or qald\$ or qale\$ or qtime\$).tw.
4.	disability adjusted life.tw.
5.	daly\$.tw.
6.	Health Status Indicators/
7.	(sf36 or sf 36 or short form 36 or shortform 36 or sf thirtysix or sf thirty six or shortform thirtysix or shortform thirty six or short form thirtysix or short form thirty six).tw.
8.	(sf6 or sf 6 or short form 6 or shortform 6 or sf six or sfsix or shortform six or short form six).tw.
9.	(sf12 or sf 12 or short form 12 or shortform 12 or sf twelve or sftwelve or shortform twelve or short form twelve).tw.
10.	(sf16 or sf 16 or short form 16 or shortform 16 or sf sixteen or sfsixteen or shortform sixteen or short form sixteen).tw.
11.	(sf20 or sf 20 or short form 20 or shortform 20 or sf twenty or sftwenty or shortform twenty or short form twenty).tw.
12.	(euroqol or euro qol or eq5d or eq 5d).tw.
13.	(hql or hqol or h qol or hrqol or hr qol).tw.
14.	(hye or hyes).tw.
15.	health\$ equivalent\$ year\$.tw.
16.	(hui or hui1 or hui2 or hui3).tw.
17.	utilit\$.tw.
18.	disutilit\$.tw.
19.	rosser.tw.
20.	quality of wellbeing.tw.
21.	qwb.tw.
22.	willingness to pay.tw.
23.	standard gamble\$.tw.
24.	time trade off.tw.
25.	time tradeoff.tw.
26.	tto.tw.
27.	or/1-26
28.	glasgow outcome scale.mp.
29.	27 or 28

Embase search terms

1.	quality adjusted life.tw.
2.	(qaly\$ or qald\$ or qale\$ or qtime\$).tw.
3.	disability adjusted life.tw.
4.	daly\$.tw.
5.	(sf36 or sf 36 or short form 36 or shortform 36 or sf thirtysix or sf thirty six or shortform thirtysix or shortform thirty six or short form thirtysix or short form thirty six).tw.
6.	(sf6 or sf 6 or short form 6 or shortform 6 or sf six or sfsix or shortform six or short form six).tw.
7.	(sf12 or sf 12 or short form 12 or shortform 12 or sf twelve or sftwelve or shortform twelve or short form twelve).tw.
8.	(sf16 or sf 16 or short form 16 or shortform 16 or sf sixteen or sfsixteen or shortform sixteen or short form sixteen).tw.
9.	(sf20 or sf 20 or short form 20 or shortform 20 or sf twenty or sftwenty or shortform twenty or short form twenty).tw.
10.	(euroqol or euro qol or eq5d or eq 5d).tw.
11.	(hql or hqol or h qol or hrqol or hr qol).tw.
12.	(hye or hyes).tw.
13.	health\$ equivalent\$ year\$.tw.
14.	(hui or hui1 or hui2 or hui3).tw.
15.	health utilit\$.tw.
16.	disutilit\$.tw.
17.	rosser.tw.
18.	(quality of wellbeing or quality of well being).tw.
19.	qwb.tw.
20.	willingness to pay.tw.
21.	standard gamble\$.tw.
22.	time trade off.tw.
23.	time tradeoff.tw.
24.	tto.tw.
25.	or/1-24
26.	glasgow outcome scale.mp.
27.	25 or 26

G.3 Searches by specific questions

G.3.1 Direct transport to hospital

- What is the effectiveness of pre-hospital assessment tools for selecting adults, infants and children with head injury for transport direct to specialist neuroscience care or a major trauma centre with neuroscience if the nearest hospital does not provide these?

Searches constructed in Medline, Embase and The Cochrane Library by combining the columns in the following table using the AND Boolean operator

Population	Intervention / exposure	Comparison	Study filter used	Date parameters
Head injury	Transport to hospital	n/a	Prediction rules (Medline and Embase only)	All years to 31/05/13
Head injury	Transport to hospital	n/a	Triage (Medline and Embase only)	All years to 31/05/13

Medline search terms

1.	exp Emergency Service, Hospital/
2.	(neuroscien* or neurosurg* or neurol* or emergency department or "accident and emergency" or "A and E" or "A & E" or A&E).ti,ab.
3.	(trauma adj (centre* or center*)).ti,ab.
4.	((speciali* or tertiary or critical care or intensive care or regional or district general) adj2 (cent* or unit* or hospital* or facilit*)).ti,ab.
5.	or/1-4
6.	"transportation of patients"/ or ambulances/
7.	(transport* or transfer* or bypass or by pass or direct).ti,ab.
8.	or/6-7
9.	5 and 8

Embase search terms

1.	emergency health service/
2.	(neuroscien* or neurosurg* or neurol* or emergency department or "accident and emergency" or "A and E" or "A & E" or A&E).ti,ab.
3.	(trauma adj (centre* or center*)).ti,ab.
4.	((speciali* or tertiary or critical care or intensive care or regional or district general) adj2 (cent* or unit* or hospital* or facilit*)).ti,ab.
5.	or/1-4
6.	patient transport/
7.	(transport* or transfer* or bypass or by pass or direct).ti,ab.
8.	or/6-7
9.	5 and 8

Cochrane search terms

#1.	MeSH descriptor: [Emergency Service, Hospital] explode all trees
#2.	(neuroscien* or neurosurg* or neurol* or emergency department or "accident and emergency" or "A and E" or "A & E" or A&E):ti,ab
#3.	(trauma near/1 (centre* or center*)):ti,ab
#4.	((speciali* or tertiary or critical care or intensive care or regional or district general) near/2

	(cent* or unit* or hospital* or facilit*):ti,ab
#5.	#1 or #2 or #3 or #4
#6.	MeSH descriptor: [Transportation of Patients] this term only
#7.	MeSH descriptor: [Ambulances] this term only
#8.	(transport* or transfer* or bypass or by pass or direct):ti,ab
#9.	#6 or #7 or #8
#10.	#5 and #9

G.3.2 CT Imaging of the head

- What is (are) the best clinical prediction rule(s) for selecting adults, infants and children with head injury for CT imaging of the head?

Search constructed in Medline, Embase and the Cochrane Library by combining the columns in the following table using the AND Boolean operator

Population	Intervention / exposure	Comparison	Study filter used	Date parameters
Head injury	CT Imaging	n/a	Prediction rules (Medline and Embase only)	From 2006 to 31/05/13

Medline search terms

1.	tomography/ or exp tomography, emission-computed/ or exp tomography, x-ray/
2.	(compute* adj2 tomograph*).ti,ab.
3.	((ct or cat) adj scan*).ti,ab.
4.	or/1-3

Embase search terms

1.	tomography/ or brain tomography/ or exp computer assisted tomography/ or exp emission tomography/
2.	(compute* adj2 tomograph*).ti,ab.
3.	((ct or cat) adj scan*).ti,ab.
4.	or/1-3

Cochrane search terms

#1.	MeSH descriptor Tomography, this term only
#2.	MeSH descriptor Tomography, Emission-Computed explode all trees
#3.	MeSH descriptor Tomography, X-Ray explode all trees
#4.	(compute* near/2 tomograph*):ti,ab
#5.	((ct or cat) next scan*):ti,ab
#6.	(#1 or #2 or #3 or #4 or #5)

G.3.3 Anticoagulants

- What is the best clinical prediction rule for selecting adults, infants and children with head injury for imaging who have no history of amnesia or loss of consciousness who are on anticoagulant or antiplatelet therapy?

Search constructed in Medline, Embase and the Cochrane Library by combining the columns in the following table using the AND Boolean operator

Population	Intervention / exposure	Comparison	Study filter used	Date parameters
Head injury	Anticoagulants	n/a	Predictive rules (Medline and Embase only)	All years to 31/05/13
Head injury	Anticoagulants and CT imaging	n/a	n/a	All years to 31/05/13

Medline search terms - Anticoagulants

1.	exp Anticoagulants/
2.	exp Platelet Aggregation Inhibitors/
3.	exp Thrombolytic Therapy/
4.	exp Fibrinolytic Agents/
5.	(antithromb* or thrombolytic* or anticoagulant* or antiplatelet*).ti,ab.
6.	(Glycoprotein or Abciximab or Eptifibatide or Tirofiban or ADP receptor or P2Y12 inhibitor* or thienopyridines or Clopidogrel or Prasugrel or Ticlopidine or Nucleotide analog* or nucleoside analog* or Cangrelor or Elinogrel or Ticagrelor or Prostaglandin analogue* or PGI2 or Beraprost or Prostacyclin or Iloprost or Treprostinil or COX inhibitor* or Acetylsalicylic acid or Aspirin or Aloxiprin or Carbasalate calcium or Indobufen or Triflusal or Thromboxane inhibitor* or thromboxane synthase inhibitors or Dipyridamole or Picotamide or Terutroban or Phosphodiesterase inhibitor* or Cilostazol or Triflusal or Cloricromen or Ditazole or Vitamin K antagonist* or Coumarin* or Acenocoumarol or Coumatetralyl or Dicoumarol or Ethyl biscoumacetate or Phenprocoumon or Warfarin or 1,3-Indandiones or Clorindione or Diphenadione or Phenindione or Tiocloamarol or Factor Xa inhibitor* or Heparin* or Glycosaminoglycan* or Bemiparin or Certoparin or Dalteparin or Enoxaparin or Nadroparin or Parnaparin or Reviparin or Tinzaparin or Oligosaccharide* or Fondaparinux or Idraparinux or heparinoid or Danaparoid or Sulodexide or Dermatan sulfate or Direct Xa inhibitor* or xabans or Apixaban or Betrixaban or Edoxaban or Otamixaban or Rivaroxaban or Direct thrombin inhibitor* or Hirudin* or Bivalirudin or Lepirudin or Desirudin or Argatroban or Dabigatran or Melagatran or Ximelagatran or Defibrotide or Ramatroban or Protein C or Drotrecogin alfa).mp.
7.	or/1-6

Medline search terms – CT Imaging

1.	tomography/ or exp tomography, emission-computed/ or exp tomography, x-ray/
2.	(compute* adj2 tomograph*).ti,ab.
3.	((cat or ct) adj scan*).ti,ab.
4.	or/1-3

Embase search terms -Anticoagulants

1.	exp anticoagulant agent/
2.	fibrinolytic therapy/
3.	(antithromb* or thrombolytic* or anticoagulant* or antiplatelet*).ti,ab.
4.	(Glycoprotein or Abciximab or Eptifibatide or Tirofiban or ADP receptor or P2Y12 inhibitor* or thienopyridines or Clopidogrel or Prasugrel or Ticlopidine or Nucleotide analog* or nucleoside

	analog* or Cangrelor or Elinogrel or Ticagrelor or Prostaglandin analogue* or PGI2 or Beraprost or Prostacyclin or Iloprost or Treprostinil or COX inhibitor* or Acetylsalicylic acid or Aspirin or Aloxiprin or Carbasalate calcium or Indobufen or Triflusal or Thromboxane inhibitor* or thromboxane synthase inhibitors or Dipyridamole or Picotamide or Terutroban or Phosphodiesterase inhibitor* or Cilostazol or Triflusal or Cloricromen or Ditazole or Vitamin K antagonist* or Coumarin* or Acenocoumarol or Coumatetralyl or Dicoumarol or Ethyl biscoumacetate or Phenprocoumon or Warfarin or 1,3-Indandiones or Clorindione or Diphenadione or Phenindione or Tiocloamarol or Factor Xa inhibitor* or Heparin* or Glycosaminoglycan* or Bemiparin or Certoparin or Dalteparin or Enoxaparin or Nadroparin or Parnaparin or Reviparin or Tinzaparin or Oligosaccharide* or Fondaparinux or Idraparinux or heparinoid or Danaparoid or Sulodexide or Dermatan sulfate or Direct Xa inhibitor* or xabans or Apixaban or Betrixaban or Edoxaban or Otamixaban or Rivaroxaban or Direct thrombin inhibitor* or Hirudin* or Bivalirudin or Lepirudin or Desirudin or Argatroban or Dabigatran or Melagatran or Ximelagatran or Defibrotide or Ramatroban or Protein C or Drotrecogin alfa).mp.
5.	or/1-4

Embase search terms – CT Imaging

1.	tomography/ or brain tomography/ or exp computer assisted tomography/ or exp emission tomography/
2.	(compute* adj2 tomograph*).ti,ab.
3.	((cat or ct) adj scan*).ti,ab.
4.	or/1-3

Cochrane search terms - Anticoagulants

#1.	MeSH descriptor: [Anticoagulants] explode all trees
#2.	MeSH descriptor: [Platelet Aggregation Inhibitors] explode all trees
#3.	MeSH descriptor: [Thrombolytic Therapy] explode all trees
#4.	MeSH descriptor: [Fibrinolytic Agents] explode all trees
#5.	(antithromb* or thrombolytic* or anticoagulant* or antiplatelet*):ti,ab
#6.	(Glycoprotein or Abciximab or Eptifibatide or Tirofiban or ADP receptor or P2Y12 inhibitor* or thienopyridines or Clopidogrel or Prasugrel or Ticlopidine or Nucleotide analog* or nucleoside analog* or Cangrelor or Elinogrel or Ticagrelor or Prostaglandin analogue* or PGI2 or Beraprost or Prostacyclin or Iloprost or Treprostinil or COX inhibitor* or Acetylsalicylic acid or Aspirin or Aloxiprin or Carbasalate calcium or Indobufen or Triflusal or Thromboxane inhibitor* or thromboxane synthase inhibitors or Dipyridamole or Picotamide or Terutroban or Phosphodiesterase inhibitor* or Cilostazol or Triflusal or Cloricromen or Ditazole or Vitamin K antagonist* or Coumarin* or Acenocoumarol or Coumatetralyl or Dicoumarol or Ethyl biscoumacetate or Phenprocoumon or Warfarin or 1,3-Indandiones or Clorindione or Diphenadione or Phenindione or Tiocloamarol or Factor Xa inhibitor* or Heparin* or Glycosaminoglycan* or Bemiparin or Certoparin or Dalteparin or Enoxaparin or Nadroparin or Parnaparin or Reviparin or Tinzaparin or Oligosaccharide* or Fondaparinux or Idraparinux or heparinoid or Danaparoid or Sulodexide or Dermatan sulfate or Direct Xa inhibitor* or xabans or Apixaban or Betrixaban or Edoxaban or Otamixaban or Rivaroxaban or Direct thrombin inhibitor* or Hirudin* or Bivalirudin or Lepirudin or Desirudin or Argatroban or Dabigatran or Melagatran or Ximelagatran or Defibrotide or Ramatroban or Protein C or Drotrecogin alfa)
#7.	#1 or #2 or #3 or #4 or #5 or #6

Cochrane search terms – CT Imaging

#1.	MeSH descriptor: [Tomography] this term only
#2.	MeSH descriptor: [Tomography, Emission-Computed] explode all trees
#3.	MeSH descriptor: [Tomography, X-Ray] explode all trees
#4.	(compute* near/2 tomograph*):ti,ab

#5.	((ct or cat) next/1 scan*):ti,ab
#6.	#1 or #2 or #3 or #4 or #5

G.3.4 Biomarkers

- What is the diagnostic accuracy of biomarkers (S100b, NSE, GFAP) in the emergency department for selecting patients with head injury for CT imaging of the head?

Search constructed in Medline, Embase and the Cochrane Library by combining the columns in the following table using the AND Boolean operator

Population	Intervention / exposure	Comparison	Study filter used	Date parameters
Head injury	Biomarkers	n/a	n/a	All years to 31/05/13

Medline search terms

1.	exp S100 Proteins/
2.	Glial Fibrillary Acidic Protein/
3.	Phosphopyruvate Hydratase/
4.	(S100b or s100 or NSE or neuron-specific enolase or GFAP or glial fibrillary acid protein).ti,ab.
5.	or/1-4

Embase search terms

1.	protein S 100/
2.	glial fibrillary acidic protein/
3.	neuron specific enolase/
4.	(S100b or s100 or NSE or neuron-specific enolase or GFAP or glial fibrillary acid protein).ti,ab.
5.	or/1-4

Cochrane search terms

#1.	MeSH descriptor: [S100 Proteins] explode all trees
#2.	MeSH descriptor: [Glial Fibrillary Acidic Protein] this term only
#3.	MeSH descriptor: [Phosphopyruvate Hydratase] this term only
#4.	(S100b or s100 or NSE or neuron-specific enolase or GFAP or glial fibrillary acid protein):ti,ab
#5.	#1 or #2 or #3 or #4

G.3.5 Cervical spine

Searches for the following three questions were run as one search:

- What is the best clinical prediction rule for determining which people with head injury should be imaged (initial imaging with X-ray or CT) for cervical spine injury?
- What is the best clinical prediction rule for determining which people with head injury, who have received a negative X-ray, should have further imaging with CT or MRI for cervical spine injury?
- What is the best clinical prediction rule for determining which people with head injury, who have received a negative CT scan, should have further imaging with MRI for cervical spine injury?

Search constructed by combining the columns in the following table using the AND Boolean operator. There were two parts to the search: the first looked for prediction rules for imaging in patients with a

cervical spine injury in Medline, Embase and the Cochrane Library; the second looked for any study for imaging in patients with head injury and a cervical spine injury in Medline and Embase only.

Population	Intervention / exposure	Comparison	Study filter used	Date parameters
Cervical spine injury	Imaging (CT or MRI or x-ray)	n/a	Predictive rules or observational studies (Medline and Embase only)	All years to 31/05/13
Head injury AND cervical spine injury	Imaging (CT or MRI or x-ray)	n/a	n/a	All years to 31/05/13

Medline search terms

1.	tomography/ or exp magnetic resonance imaging/ or exp tomography, emission-computed/ or exp tomography, x-ray/ or Radiography/ or Neuroradiography/
2.	(compute* adj2 tomograph*).ti,ab.
3.	((ct or cat) adj scan*).ti,ab.
4.	((MR or magnetic resonance or NMR) adj2 (imag* or tomograph* or angiograph*)).ti,ab.
5.	MRI.ti,ab.
6.	(radiograph* or xray* or x-ray* or x ray*).ti,ab.
7.	Or/1-7

Embase search terms

1.	tomography/ or brain tomography/ or exp computer assisted tomography/ or exp emission tomography/ or exp nuclear magnetic resonance imaging/ or radiography/
2.	(compute* adj2 tomograph*).ti,ab.
3.	((ct or cat) adj scan*).ti,ab.
4.	((MR or magnetic resonance or NMR) adj2 (imag* or tomograph* or angiograph*)).ti,ab.
5.	MRI.ti,ab.
6.	(skull adj2 (xray* or x-ray* or radiograph*)).ti,ab.
7.	or/1-6

Cochrane search terms

#1.	MeSH descriptor Tomography, this term only
#2.	MeSH descriptor Tomography, Emission-Computed explode all trees
#3.	MeSH descriptor Tomography, X-Ray explode all trees
#4.	(compute* near/2 tomograph*):ti,ab
#5.	((ct or cat) near/2 scan*):ti,ab
#6.	MeSH descriptor Magnetic Resonance Imaging explode all trees
#7.	((MR or magnetic resonance or NMR) near/2 (imag* or tomograph* or angiograph*)):ti,ab
#8.	MRI:ti,ab
#9.	MeSH descriptor Radiography, this term only
#10.	MeSH descriptor Neuroradiography, this term only
#11.	(radiograph* or xray* or x-ray* or x ray*):ti,ab
#12.	(#1 or #2 or #3 or #4 or #5 or #6 or #7 or #8 or #9 or #10 or #11)

G.3.6 Patient information

Searches for the following two questions were run as one search:

- What information and support do patients with head injury, with or without cervical spine injury, say they want?
- What discharge information should be given to patients with head injury with or without cervical spine injury?

Search constructed in Medline, Embase and Cinahl by combining the columns in the following table using the AND Boolean operator

Population	Intervention / exposure	Comparison	Study filter used	Date parameters
Head injury	n/a	n/a	Patient views and qualitative studies	From 2003 to 31/05/13

G.4 Economics searches

G.4.1 Economics reviews

Economic searches were conducted in Medline, Embase, HEED and CRD for NHS EED and HTA.

Population	Intervention / exposure	Comparison	Study filter used	Date parameters
People of any age with a head injury	n/a	n/a	Economic (Medline and Embase only)	Medline and Embase from 2010 to 31/05/13 CRD and HEED from 2006 to 31/05/13

CRD search terms

#1	MeSH DESCRIPTOR Craniocerebral Trauma EXPLODE ALL TREES
#2	(((head or brain) adj3 (injur* or trauma))) OR ((skull adj3 fracture*))
#3	(((cerebral or craniocerebral) adj3 trauma))
#4	#1 OR #2 OR #3

HEED search terms

1.	ax= head injury within 3
2.	ax= head injuries within 3
3.	ax= brain injury within 3
4.	ax= brain injuries within 3
5.	ax= head trauma within 3
6.	ax= brain trauma within 3
7.	ax= skull fracture within 3
8.	ax= skull fractures within 3
9.	ax= skull fractured within 3
10.	ax= cerebral trauma within 3
11.	ax= craniocerebral trauma within 3
12.	cs= 1 or 2 or 3 or 4 or 5 or 6 or 7 or 8 or 9 or 10 or 11

G.4.2 Quality of life searches

Quality of life searches were conducted in Medline and Embase for two specific areas: patients using anticoagulation therapy and patients with a cervical spine injury.

Population	Intervention / exposure	Comparison	Study filter used	Date parameters
People of any age with a head injury	Anticoagulation	n/a	Quality of life	All years to 31/05/13
Cervical spine injury	n/a	n/a	Quality of life	All years to 31/05/13

Appendix H: Clinical evidence tables

Table 12: List of abbreviations used

CATCH	Canadian Assessment of Tomography for Childhood Injury
CCHR	Canadian Head CT Rule
CCR	Canadian Cervical Spine Rule
CHALICE	Children's Head injury Algorithm for the prediction of Important Clinical Events
CHIP	CT in Head Injury Patients
CT	Computed tomography
ED	Emergency department
FN	False-negative
FP	False-positive
GCS	Glasgow Coma Scale or Score
GFAP	Glial fibrillary acidic protein
HTA	Health Technology Assessment
ICI	Intracranial injury
IQR	Interquartile range
LOC	Loss of Consciousness
MHI	Minor head injury
MRI	Magnetic Resonance Imaging
NA	Not applicable
NR	Not reported
NCWFNS	Neurotraumatology Committee of the World Federation of Neurosurgical Societies
NEXUS	National Emergency X-Radiography Utilization Study
NOC	New Orleans Criteria
NPV	Negative predictive value
NSE	Neuron-specific enolase
OR	Odds ratio
PECARN	Paediatric Emergency Care Applied Research Network
PPV	Positive predictive value
S100B	S100 calcium-binding protein B
SEM	Standard error of the mean
TBI	Traumatic Brain Injury

TN	True-negative
TP	True-positive

H.1 Clinical decision rules for imaging the head

Table 11: Bouida 2013

Reference	Study type	Number of patients	Patient characteristics	Intervention and comparison (Index test and reference standard)	Outcome measures	Effect sizes	Comments
Bouida 2013 ⁵⁴	Prospective diagnostic cohort (validation of Canadian CT head rule and the New Orleans Criteria) <u>Setting:</u> Multicenter study, Tunisia	N = 1582 (1664 with 82 excluded due to incomplete data). <u>Inclusion criteria:</u> Consecutive patients presenting to the emergency department with mild head injury (blunt trauma to the head within 24h, with a GCS of 13 - 15 and at least one of: history of loss of consciousness, short-term memory deficit, amnesia for the traumatic event, posttraumatic seizure, vomiting, headache, external evidence of injury above the clavicles, confusion, and	Age, mean (range) = 32, (14 - 97) Sex, male = 1212 (76.6%) Initial score on GCS 15 = 1249 Received CT = 1122 (70.9%)	Baseline data recorded and included clinical criteria to define New Orleans Criteria and Canadian Head rule decision rule. Participating physicians were asked to indicate at the end of their initial assessment whether the patient was rule positive or negative. After clinical assessment, a standard CT scan of the head was performed at the discretion of the treating physician. 2 senior radiologists, blinded to the patient data, independently interpreted the CT scan. Follow up information for patients who did not undergo CT scanning was collected by structured telephone interview. Patients discharged home received instructions for observation and return to the ED for clinical reassessment if they had: headache, memory and concentration problems, seizure, focal motor findings, and inability	<u>Intracranial lesion</u> (Canadian CT Head Rule) <u>Neurosurgical intervention</u> (Canadian CT Head Rule)	TP = 207 FP = 472 FN= 11 TN = 892 Sensitivity = 95 (92 - 98) Specificity = 64 (62 - 68) PPV = 30 (27 - 33) NPV = 99 (98 - 100) TP = 34 FP = 622 FN= 0 TN = 926 Sensitivity = 100 (90 - 100) Specificity = 60 (44 - 76) PPV = 5 (3 - 7) NPV = 100 (99 - 100)	<u>Source of funding:</u> Research supported by a grant from the Tunisian State Department of Research.

Reference	Study type	Number of patients	Patient characteristics	Intervention and comparison (Index test and reference standard)	Outcome measures	Effect sizes	Comments
		<p>neurological deficit.</p> <p><u>Exclusion criteria:</u> Younger than 10 years, had a GCS < 13 or instable vital signs, were pregnant, received warfarin or had a bleeding disorder, had an obvious penetrating skull injury, or had contraindications for CT..</p>		<p>to return to usual daily activities.</p> <p>Need for neurosurgical intervention: death or need for any of the following within 30 days of injury: craniotomy, monitoring of intracranial pressure, need for intubation for the treatment of head injury. Brain lesions defined as any acute intracranial finding revealed on CT that was attributable to acute injury.</p> <p>Patients who did not undergo CT were classified as having no clinically important brain injury if at 15 days after ED discharge none of the above criteria requiring return to ED are present,.</p>	<p><u>Intracranial lesion</u> (New Orleans criteria)</p>	<p>TP = 187 FP = 976 FN= 31 TN = 388 Sensitivity = 86 (81 - 91) Specificity = 28 (26 - 30) PPV = 16 (14 - 18) NPV = 93 (90 - 96)</p>	
					<p><u>Neurosurgical intervention</u> (New Orleans criteria)</p>	<p>TP = 28 FP = 1152 FN= 6 TN = 396 Sensitivity = 82 (69 - 95) Specificity = 26 (24 - 28) PPV = 2 (1 - 3) NPV = 99 (98 - 100)</p>	

Table 13: Fabbri 2011

Reference	Study type	Number of patients	Patient characteristics	Intervention and comparison (Index test and reference standard)	Outcome measures	Effect sizes	Comments
Fabbri 2011 ^{133,137}	Prospective diagnostic cohort (validation of NEXUS and derivation of a new rule) <u>Setting:</u> Multicenter study, Italy	N = 2391 <u>Inclusion criteria:</u> Consecutively triaged children within 24h after injury, aged ≤10 years. <u>Exclusion criteria:</u> Head injuries needing sedation for intubation before emergency department admission, multiple injuries, severe hypotension caused by extracranial injuries and penetrating injuries.	Age, Median (range) = 3 (IQR, 1-5) Sex, male = 2502 (64.8%) Initial score on GCS 15 = 3489 (90.2%) 14 = 282 (7.3%) 13 = 95(2.5%) Received CT = 2043 (52.8%) 1823 = discharged directly from emergency department	Review of all children with documented intracranial lesions in medical databases. A member of the emergency department then contacted all cases by means of a structured telephone interview to evaluate the outcome by GCS at 6 months follow up.	<u>Intracranial lesion (NEXUS)</u>	TP = 16 FP = 963 FN= 2 TN = 1410 Sensitivity = 88.9 (63.9 -95.6) Specificity = 59.4 (57.4 – 61.3) NPV = 99.9	<u>Source of funding:</u> None reported
				Main outcome was post traumatic lesion on CT scan within 7 days after injury. Posttraumatic lesions requiring admission to hospital and follow-up included: intracerebral hematoma or brain contusion, traumatic subarachnoid haemorrhage, subdural haemorrhage, epidural hematoma, intraventricular haemorrhage and a depressed skull fracture. NEXUS II rule used or Italian proposal, which consisted of: Abnormal GCS, evidence of skull or base fracture, abnormal neurologic examination, vomiting, loss of consciousness, drowsiness or amnesia, headache, impact seizure.	<u>Intracranial lesion (Italian proposal)</u>	TP = 18 FP = 566 FN= 0 TN = 1807 Sensitivity = 1.00 [78.1 – 99.7] Specificity = 76.1 [74.4 – 77.8] NPV= 100	

Table 14: Fuller 2011

Reference	Study type	Number of patients	Patient characteristics	Intervention and comparison (Index test and reference standard)	Outcome measures	Effect sizes	Comments
Fuller 2011 ¹⁵⁵	Prospective cohort (retrospective database search) Validation of PECARN in CHALICE data set. <u>Setting:</u> UK	N = 22,772 (10415 suitable for PECARN rule 5 - 16 years, 4717 suitable for < 2 years) <u>Inclusion criteria:</u> Children 5 - 16 years presenting to the emergency department of 10 northwest England hospitals with head injury. Additional information from authors: Children <2 years from CHALICE cohort. <u>Exclusion criteria:</u> None reported	Entire cohort: Age, mean = 5.7 years Sex, male = 65%	CHALICE patients >5 years were categorised according to PECARN CDR predictors and outcomes (clinically important head injury: death from head injury, neurosurgery, intubation >24h, hospital admission >2 nights with positive CT head).	<u>Intracranial lesion</u> (5 - 16 years)	Sensitivity = 95 (91 - 97) Specificity = 75 (74 - 76) NPV = 99.8 (99.7 - 99.9)	<u>Source of funding:</u> None reported
					Additional information from authors: (5 - 16 years)	TP = 234 FP = 2544 FN= 12 TN = 7625 PPV = 8.4 (7.4 - 9.5)	
					Additional information from authors: <u>Intracranial lesion</u> (<2 years)	TP = 17 FP = 1750 FN= 0 TN = 2950 Sensitivity = 100 (80.5 - 100) Specificity = 62.8 (61.4 - 64.2) NPV = 100 (99.9 - 100) PPV = 0.96 (0.6 - 1.5)	

Table 15: Osmond 2010

Reference	Study type	Number of patients	Patient characteristics	Intervention and comparison (Index test and reference standard)	Outcome measures	Effect sizes	Comments
Osmond 2010 ^{370,371} Linked to Osmond 2006 (abstract only) ³⁷⁰ Validation provided in Osmond 2012 ³⁶⁹ (abstract only)	Prospective diagnostic cohort (derivation of the CATCH decision rule) <u>Setting:</u> 10 Canadian paediatric teaching institutions	N = 3866 <u>Inclusion criteria:</u> 1) Consecutive children enrolled, 0 – 16 years 2) Blunt trauma to the head resulting in witnessed loss of consciousness, definite amnesia, witnessed disorientation, persistent vomiting (≥ 2 more distinct episodes of vomiting 15 mins apart) or persistent irritability in the emergency department (children <2 years). 3) Initial score of 13 GCS, in emergency department, as determined by the treating physician. 4) Injury within past 24 hours.	Consecutive children enrolled, 0 – 16 years Age, Median (range) = 10 (0-16) Sex, male = 2502 (64.8%) Initial score on GCS 15 = 3489 (90.2%) 14 = 282 (7.3%) 13 = 95(2.5%) Received CT = 2043 (52.8%) 1823 = discharged directly from emergency department	Patients underwent clinical examination, treating physician determined whether a CT of the head was required. Radiologists interpreted CT blinded to data collection form. Patients who did not receive a CT were classified as not having a clinically important brain injury after follow up at 14 days by telephone interview (headache absent or mild, no memory or concentration problems, no seizures and returned to usual daily activities e.g. feeding, sleeping, school, play, work). Patients who did not undergo CT and not reached for follow up were excluded from final analysis (n = 245). Variables (from history and physical examination) with the highest association with brain injury found on physical examination and a rule was derived using recursive partitioning analysis:	<u>Brain injury</u> - high and medium risk (any acute intracranial finding revealed on CT that was attributable to acute injury, including closed depressed skull fracture and pneumocephalus, but excluding non depressed skull fractures and basilar skull fractures.) Neurological intervention - high risk (death within 7 days secondary to head injury or need for craniotomy, elevation of skull fracture, monitoring of intracranial pressure or insertion of an	24 (0.6%) (underwent neurologically intervention) CATCH rule: TP = 156 FP = 1851 FN= 3 TN = 1856 Sensitivity = 98.1 [95, 100] Specificity = 50.1 [48, 52] TP = 24 FP = 1144 FN= 0 TN = 2698 Sensitivity = 100 [86 - 100] Specificity = 70.2 [69 - 72]	<u>Source of funding:</u> Funded by grants from the Canadian Institutes of Health Research (CIHR funding reference MOP-43911), the emergency Health services Branch of the Ontario Ministry of Health and Long-Term Care and the Alberta Children’s Hospital Foundation.

Reference	Study type	Number of patients	Patient characteristics	Intervention and comparison (Index test and reference standard)	Outcome measures	Effect sizes	Comments
		<p><u>Exclusion criteria:</u></p> <p>1) Obvious penetrating skull injury or obvious depressed fracture, acute focal neurologic deficit, chronic generalised developmental delay or head injury secondary to suspected child abuse.</p> <p>2) Patients returning for reassessment of a previously treated head injury and those who were pregnant.</p>		<p>Canadian Assessment of Tomography for Childhood Head Injury: the CATCH rule</p> <p><u>High risk (need for neurologic intervention)</u></p> <p>1) GCS <15 at 3 hours after injury</p> <p>2) Suspected open or depressed skull fracture</p> <p>3) History of worsening headache</p> <p>4) Irritability on examination</p> <p><u>Medium risk (brain injury on CT scan)</u></p> <p>5) Any sign of basal skull fracture</p> <p>6) Large, boggy haematoma of the scalp</p> <p>7) Dangerous mechanism of injury</p>	<p>endotracheal tube for treatment of head injury)</p>		
					<p>Validation of CATCH rule, n = 4060</p> <p><u>Neurological intervention - high risk</u></p>	<p>CATCH rule:</p> <p>TP = 20</p> <p>FP = 538</p> <p>FN= 3</p> <p>TN = 3487</p> <p>Sensitivity = 87 [68 - 95]</p> <p>Specificity = 87 [86 - 86 - 88]</p>	
					<p>Validation of CATCH rule, n = 4060</p> <p><u>Brain injury - high and medium risk</u></p>	<p>CATCH rule:</p> <p>TP = 193</p> <p>FP = 1331</p> <p>FN= 4</p> <p>TN = 2520</p> <p>Sensitivity = 98 [95 - 99]</p> <p>Specificity = 65 [64 - 67]</p>	

Table 16: Pandor 2011

Reference	Study type	Number of patients	Patient characteristics	Intervention and comparison (Index test and reference standard)	Outcome measures	Effect sizes	Comments
<p>Pandor et al, 2011³⁷⁹</p> <p>Only data relating to decision rules presented here. HTA report also reviews studies relating to bio-markers, individual patient characteristics</p>	<p>Health Technology Assessment systematic review of diagnostic cohort studies (prospective or retrospective) with a minimum of 20 patients</p> <p>Excluded: Case control studies, animal studies, narrative reviews, editorials, opinions, non-English language papers, reports in which insufficient methodological details reported to allow critical appraisal of the study quality.</p>	<p><u>Adults</u> N = 19 studies reporting data for 25 decision rules, 11 were evaluated in more than one dataset 6 also stratified into two categories, one to identify those needing neurosurgery (high risk) and one to identify those at risk of ICI (medium risk) 6 included coagulopathy as part of the decision rule (criteria varied between rules).</p> <p><u>Children</u> N = 14 studies reporting data for 15 decision rules, 4 were evaluated in more than one dataset for ICI only 4 presented more</p>	<p><u>Inclusion criteria</u> Population: All adults and children of any age with mild head injury (defined as patients with blunt head injury and a GCS of 13-15 at presentation. Studies with a broad range of head injury provided >50% had mild head injury.</p> <p><u>Exclusion criteria:</u> Population: Moderate or severe head injury (defined as GCS of ≤ 12 at presentation) or no history of injury.</p>	<p>Index tests:</p> <ul style="list-style-type: none"> Application of a clinical decision rule (defined as a decision making toll that incorporates 3 or more variables obtained from the history, physical examination or simple diagnostic tests) <p>Reference standard:</p> <ul style="list-style-type: none"> CT scan Combination of CT scan and follow-up for those without CT scan MRI scan 	<p>The need for neurosurgical intervention</p> <p>Any intracranial injury</p>	<p>Each study tests their population against one or more decision rules. Results given in forest plots. Summary of studies and rules tested presented in Table 18 - Table 21 below.</p>	<p><u>Source of funding:</u> National Institute for Health Research (NIHR) Health Technology Assessment programme</p>

Reference	Study type	Number of patients	Patient characteristics	Intervention and comparison (Index test and reference standard)	Outcome measures	Effect sizes	Comments
		than one version of the rule					

Table 17: Ro 2011

Reference	Study type	Number of patients	Patient characteristics	Intervention and comparison (Index test and reference standard)	Outcome measures	Effect sizes	Comments
Ro 2011 ⁴¹⁸	Prospective diagnostic cohort (comparing CCHR, NOC and NEXUS II CT rules) Setting: 5 tertiary academic emergency departments in Korea.	N = 7131 <u>Inclusion criteria:</u> Consecutive patients enrolled who sustained acute blunt head trauma (any physical evidence of head trauma, unless they had an obvious penetrating head injury).	Patients with minor head injury Number of patients meeting inclusion criteria for rules: CCHR: 696 Mean age (SD) = 46.1 (\pm 18.9) Sex, male = 477 (68.5%) NOC: 657 Mean age (SD) = 42.8 (\pm 20.7) Sex, male = 451 (68.7%) NEXUS II: 2951 Mean age (SD) = 39.9 (\pm 22.9)	Used a surveillance registry to capture predictive variables for intracranial injury based on CT rules. Patients stratified according to CCHR (high and medium risk criteria), NOC and NEXUS II rules. Patients enrolled were only considered for decision rule analyses if they met the inclusion/exclusion criteria of the specific decision rules. Primary data collection was by general physicians (injury team). Not all patients underwent CT, but all patients underwent a structured proxy outcome measure via telephone to capture admission and operation history and other hospital and neurologic outcomes at 6 months. CT scans were interpreted by the clinical radiologist and also	<u>Clinically important brain injury</u> (any traumatic finding identified on CT scan that required hospital admission and neurosurgical follow-up).	CCHR TP = 112 FP = 32 FN= 228 TN = 324 Sensitivity = 79.2% (70.8 – 86%) Specificity = 41.3% (37.3 – 45.5%) NOC TP = 91 FP = 433 FN= 8 TN = 125 Sensitivity = 91.9% (84.7 – 96.5%) Specificity = 22.4% (19 – 26.1%) NEXUS II TP = 511	<u>Source of funding:</u> Korean Centers for Disease Control and Prevention

Reference	Study type	Number of patients	Patient characteristics	Intervention and comparison (Index test and reference standard)	Outcome measures	Effect sizes	Comments
			Sex, male = 2059 (69.8%)	independently retrospectively reviewed by an emergency physician.		FP = 1271 FN= 65 TN = 1104 Sensitivity = 88.7% (85.8 – 91.2%) Specificity = 46.5% (44.5 – 48.5%)	
					<u>Need for neurosurgical intervention</u> (death within 7 days secondary to TBI, or need for craniotomy, elevation of skull fracture, intracranial pressure monitoring, or intubation due to TBI within 7 days of injury)	CCHR Sensitivity = 100% (59 - 100%) Specificity = 38.3% (34.5 – 41.9%) NOC Sensitivity = 100% (54.1 - 100%) Specificity = 20.4% (17.4 – 23.7%) NEXUS II Sensitivity = 95.1% (90.1 – 98.0%) Specificity = 41.4% (39.5 – 43.2%)	

H.2 Clinical decision rules for imaging the head; summary of studies included

H.2.1 Adult rules

Table 18: Summary of studies reproduced from the HTA: decision rules for adults with mild head injury, definitions of outcomes and reference standards

Study	Rule(s) tested	Definition of ICI	Reference standard used for ICI	Patients who had CT (n)	Definition of need for neurosurgery	Reference standard used for need for neurosurgery
Arienta et al. 1997 ¹⁷	Arienta et al. 1997 ¹⁷	Intracranial lesion: not defined. Injuries listed include extradural haematoma, cortical contusion, subarachnoid haemorrhage, pneumocephalus, depressed fracture with contusion, intracerebral haematoma and subdural haematoma	CT scan or follow-up telephone call. Further details NR	762/9917 (7.7%)	Neurosurgery or death	Retrospective chart review, telephone follow-up
Fabbri et al. 2005 ¹³² ; Stein et al. 2009 ⁴⁸⁴	CCHR ^{495,497} , NCWFNS ⁴⁵⁷ , NICE ³⁴⁴ , NOC ¹⁹⁴ , Nexus II ³²⁷ , Scandinavia n ²²⁵	Stein et al. 2009 – any lesion: surgical (intracranial haematoma large enough to require surgical evacuation) or nonsurgical (other intracranial abnormality diagnosed on CT) Fabbri et al. 2005 – any post-traumatic lesion at CT within 7 days from trauma: depressed skull fracture, intracerebral haematoma/brain contusions, subarachnoid haemorrhage, subdural haematoma, epidural haematoma, intraventricular haemorrhage	Patients were managed accord to NCWFS guidelines where low-risk patients sent home without CT, medium risk patients given CT and observed for 3–6 hours if negative then discharged, high-risk patients given CT and observed 24–48 hours. All discharged with written advice of signs and symptoms with which they should return	4177/7955 (52.5%)	Stein et al. 2009 – surgical intracranial lesion: intracranial haematoma large enough to require surgical evacuation Fabbri et al. 2005: Haematoma evacuation, skull fracture elevation within first 7 days of injury. Injuries after this period not considered in this analysis	Assume Hospital records

Study	Rule(s) tested	Definition of ICI	Reference standard used for ICI	Patients who had CT (n)	Definition of need for neurosurgery	Reference standard used for need for neurosurgery
Haydel et al. 2000 ¹⁹⁴	NOC ¹⁹⁴	ICI – presence of acute traumatic ICI: a subdural, epidural or parenchymal haematoma, subarachnoid haemorrhage, cerebral contusion or depressed skull fracture	CT scan	520/520 (100%) 909/909 (100%)a	NA	NA
Holmes et al. 1997 ²¹⁷	Miller et al. 1997 ³⁰⁹	Abnormal CT scan: any CT scan showing an acute traumatic lesion (skull fractures or intracranial lesions: cerebral oedema, contusion, parenchymal haemorrhage, epidural haematoma, subdural haematoma, subarachnoid haemorrhage or intraventricular haemorrhage)	CT scan: patients with abnormal CT scan followed to discharge; those with normal CT not studied further	264/264 (100%)	Neurosurgery	Patients with abnormal CT scan followed to discharge Those with normal CT not studied further
Ibanez and Arikan 2004 ²²⁴	Ibanez and Arikan 2004 ²²⁴ , Stein 1996 ⁴⁸¹ , Tomei et al. 1996 ⁵¹⁵ , Arienta et al. 1997 ¹⁷ , Lapierre 1998 ²⁶¹ , Murshid 1998 ³³⁷ , NOC ¹⁹⁴ ,	Relevant positive CT scan: acute intracranial lesion, not including isolated cases of linear skull fractures or chronic subdural effusions	CT scan	1101/1101 (100%)	NA	NA

Study	Rule(s) tested	Definition of ICI	Reference standard used for ICI	Patients who had CT (n)	Definition of need for neurosurgery	Reference standard used for need for neurosurgery
	Scandinavia n ²²⁵ , SIGN 2000 ⁴⁵³ , NCWFNS ⁴⁵⁷ , CCHR ^{495,497} , EFNS ⁵³⁰					
Madden et al. 1995 ²⁸⁶	Madden et al. 1995 ²⁸⁶	Clinically significant scan: pathology related to trauma affecting the bony calvaria or cerebrum (including non-depressed skull fractures, excluding scalp haematomas, those with no bony skull or intracerebral pathology)	CT scan: scans examined for bony and soft tissue injury, herniation, pneumocephalus, penetrating injury and the size and location of any cortical contusions, lacerations or external axial haematomas	537/537 (100%) 273/273 (100%) ^(a)	NA	NA
Miller et al. 1997 ³⁰⁹	Miller et al. 1997 ³⁰⁹	Abnormal CT scan: acute traumatic intracranial lesion (contusion, parenchymal haematoma, epidural haematoma, subdural haematoma, subarachnoid haemorrhage) or a skull fracture	CT scan: within 8 hours of injury	2143/2143 (100%)	Surgical intervention: craniotomy to repair an acute traumatic injury or placement of a monitoring bolt	Hospital records of those with positive CT scan followed until discharge
Mower et al. 2005 ³²⁷	NEXUS II ³²⁷	Significant ICI: any injury that may require neurosurgical intervention, (craniotomy, intracranial pressure monitoring, mechanical ventilation), lead to rapid clinical deterioration or result in significant long-term	CT scan	13,728/13,728 (100%)	NA	NA

Study	Rule(s) tested	Definition of ICI	Reference standard used for ICI	Patients who had CT (n)	Definition of need for neurosurgery	Reference standard used for need for neurosurgery
		neurological impairment				
Ono et al. 2007 ³⁶⁶	Ono et al. 2007 ³⁶⁶	Intracranial lesion: not defined. Injuries listed include subdural and epidural haematoma, subarachnoid haemorrhage, contusion, pneumocephalus	CT scan	1064/1064 (100%), 152/168 (90.5%) ^(a)	NA	NA
Rosengren et al. 2004 ⁴²⁵	CCHR ^{495,497}	Clinically significant ICI: CT abnormalities not significant if patient neurologically intact and had only one of the following: solitary contusion < 5 mm in diameter, localised subarachnoid blood < 1 mm thick, smear subdural haematoma < 4 mm thick, isolated pneumocephaly, closed depressed skull fracture not through the inner table (as per Stiell et al. 2001)	CT scan	240/240 (100%)	Neurological intervention: not defined	NA
Smits et al. 2005 ⁴⁷²	CCHR ^{495,497} , NOC ¹⁹⁴ , CHIP ^{473,474} , NCWFNS ⁴⁵⁷ , EFNS ⁵³⁰ , NICE ³⁴⁴ , SIGN ⁴⁵³ , Scandinavian ²²⁵ , CHIP	Any neurocranial traumatic finding on CT: any skull or skull base fracture and any intracranial traumatic lesion Smits et al. 2007 (CHIP derivation) definition differs: any intracranial traumatic findings on CT that included all neurocranial traumatic findings except for isolated linear skull fractures	CT scan	3181/3181 (100%) 1307/1307 (100%) ^(b)	Neurosurgery: a neurosurgical intervention was any neurosurgical procedure (craniotomy, intracranial pressure monitoring, elevation of depressed skull fracture or ventricular drainage) performed within 30 days of the event	Assume patient records

Study	Rule(s) tested	Definition of ICI	Reference standard used for ICI	Patients who had CT (n)	Definition of need for neurosurgery	Reference standard used for need for neurosurgery
Stiell et al. 2001 ⁴⁹⁴	CCHR ^{495,497}	Clinically important brain injury on CT: all injuries unless patient neurologically intact and had one of following: solitary contusion < 5 mm, localised subarachnoid blood < 1 mm thick, smear subdural haematoma < 4 mm thick, closed depressed skull fracture not through inner table	1. CT scan ordered on basis of judgement of physician in ED or result of follow-up telephone interview 2. Proxy telephone interview performed by registered nurse (24.4%). For those whose responses did not warrant recall for a CT scan this was the only reference standard	2078/3121 (67%)	Within 7 days: death due to head injury, craniotomy, elevation of skull fracture, intracranial pressure monitoring, intubation for head injury demonstrated on CT	Performance Of neurosurgery as reported in patient records and 14-day follow up telephone interview (interview 100% sensitive for need for neurosurgery)
Stiell et al. 2005 ⁴⁹³	CCHR ^{495,497} , NOC ¹⁹⁴	As per Stiell et al. 2006	As per Stiell et al. 2001	2171/2707 (80.2%) 1378/1822 (75.6%) ^(b)	As per Stiell et al. 2001 ²⁶	As per Stiell et al. 2001

CHIP, CT in Head Injury Patients; EFNS, European Federation of Neurological Societies; ICD, International Classification of Diseases; NA, not applicable; NCWFNS, Neurotraumatology Committee of the World Federation of Neurosurgical Societies; NEXUS II, National Emergency X-Radiography Utilization Study II; NR, not reported.

(a) Different cohort of data.

(b) Subset of cohort.

Table 19: Decision rules for adults with mild head injury reproduced from the HTA

Criteria	CCHR – High risk	CCHR – Medium risk	NOC	NICE 2003, 2007 ^a - lenient	NICE 2003, 2007 ^a - strict	NCWFNS – high risk	NCWFNS – medium risk	Arienta ^b groups β and γ
Tested in study by	Stiell 2001, Stiell 2005, Stein 2009, Rosengren 2004	Stiell 2001, Steill 2005, Stein 2009, Rosengren 2004, Smits 2005, Ibanez 2004 ^c	Haydel 2000, Ibanez 2004, Smits 2005, Stiell 2005, Stein 2009	Fabbri 2005 (NICE 2003), Smits 2007 (NICE 2003), Stein 2009 (NICE 2007)	Smits 2007	Smits 2007	Fabbri 2005, Smits 2007, Stein 2009, Ibanez 2004 ^c	Arienta 1997, Ibanez 2004 ^c
Eligibility criteria ^d	GCS 13-15, clinical characteristics. Some significant exclusions.		GCS 15, clinical characteristics ^{e-g}	Sustained head injury		Mild, minor or trivial head injury (GCS 14-15 ^h)		Head Injury (GCS 9-15)
Mental status								Impaired consciousness
Focal/neurological deficits				Any		Neurological deficits		Neurological deficits
Skull fracture	Suspected open, depressed or basal			Suspected open, depressed or basal ⁱ		Any		Otorrhagia/otorrhoea, rhinorrhoea, signs of basal skull fracture
LOC							Any	Transitory
Vomiting	≥2		Any	Recurrent			Any	Any
Age	≥65		>60 years	≥65 years if with LOC/amnesia ^{a,i}		>60 years ^{jk}		
Amnesia		Amnesia before impact of ≥30 minutes		Amnesia before impact of ≥30 minutes				Any
Coagulopathy				If with LOC/amnesia ⁱ		Any		Anticoagulant therapy or coagulopathy
Seizures			Any	PTS		Pre-trauma epilepsy		Any or epileptic
Visible injury			Trauma above clavicles					Penetrating or perforated

Criteria	CCHR – High risk	CCHR – Medium risk	NOC	NICE 2003, 2007 ^a - lenient	NICE 2003, 2007 ^a - strict	NCWFNS – high risk	NCWFNS – medium risk	Arienta ^b groups β and γ
								wounds
Intoxication			Any			Any		Alcoholic patients
Behaviour								Uncooperative
Headache			Any				Diffuse	
Previous neurosurgery								Intracranial operations
Failure to improve	GCS <15 at 2 hours after injury			GCS <15 at 2 hours after injury ^j		Any		
Mechanism of injury		Dangerous ^l		Dangerous, if with LOC/amnesia ⁱ				
Deterioration in mental status								
Other								Subgaleal swelling

Table 20: Decision rules for adults with mild head injury reproduced from HTA continued

Criteria	EFNS ^m – CT mandatory	EFNS – CT recommended	Madden 1995	ONO 2007	Scandinavian – CT mandatory	Scandinavian – CT recommended	SIGN 2000 – CT as emergency	SIGN 2000 – CT urgently	NEXUS II
Tested in study by	Smits 2007	Ibanez 2004 ^c , Smits 2007	Madden 1995	Ono 2007	Smits 2007	Smits 2007, Smits 2007, Ibanez 2004 ^c	Smits 2007	Smits 2007, Ibanez 2004 ^c	Stein 2009, Mower 2005
Eligibility criteria ^d	Mild TBI, GCS 13-15		Acute head trauma	MHI	Minimal, mild and moderate head injury		Patients with head injury		Blunt head trauma
Mental status	GCS 13-15	GCS 15	GCS <15 ^p	JCS >0	GCS 9-13	GCS 14-15 ⁿ	GCS ≤12 ^o	GCS <15 with failure to	Altered level of alertness

Criteria	EFNS ^m – CT mandatory	EFNS – CT recommended	Madden 1995	ONO 2007	Scandinavian – CT mandatory	Scandinavian – CT recommended	SIGN 2000 – CT as emergency	SIGN 2000 – CT urgently	NEXUS II
								improve within 4 hours	
Focal/neurological deficits	Present	P	Acute papillary inequality		Present		Progressive signs	New signs that are not getting worse	Neurological deficit
Skull fracture	Clinical signs skull fracture (skull base or depressed)	P	Palpable depressed skull fracture, signs of basilar skull fracture		Radiographically demonstrated skull fracture or clinical signs of depressed or basal skull fracture			Radiological/clinical evidence of a fracture. whatever the level of consciousness	Evidence of significant skull fracture
LOC		<30 minutes ^p	History of LOC or LOC>5 mins	Any	>5 minutes	≤5 minutes		O	
Vomiting	Any	P		Vomiting or nausea				Nausea or vomiting	Persistent
Age	<2 years ^p or >60 years			60 years ^p					≥65 years
Amnesia	Continued PTA	PTA <60 minutes		Any				O	
Coagulopathy	Coagulation disorders	P			Therapeutic anticoagulation or haemophilia				Coagulopathy
Seizures	Any	P			PTS				
Visible injury	Trauma above clavicles	P	Facial injury, penetrating skull injury						Scalp haematoma
Intoxication	Alcohol/drugs	P							
Behaviour			Combativeness					Irritability/altered behaviour	Abnormal behaviour

Criteria	EFNS ^m – CT mandatory	EFNS – CT recommended	Madden 1995	ONO 2007	Scandinavian – CT mandatory	Scandinavian – CT recommended	SIGN 2000 – CT as emergency	SIGN 2000 – CT urgently	NEXUS II
Headache	Severe	P		Any				Severe or persistent	
Previous neurosurgery					Shunt-treated hydrocephalus				
Failure to improve								Failure to improve (from GCS <15) within 4 hours of clinical observation	
Mechanism of injury	High-energy accident ^q	P						0	
Deterioration in mental status			Decreasing level of consciousness				Deteriorating level of consciousness		
Other	Unclear or ambiguous accident history	P			Multiple injuries			'Other features' are not fully enumerated ^o	

EFNS, European Federation of Neurological Societies; JCS, Japanese Coma Scale; NEXUS II, National Emergency X-Radiography Utilization Study II; PTA, post-traumatic amnesia.

- (a) NICE 2003 and 2007 rules: for children < 16 years, there are additional indications listed in the 2007 update. These may have been applied by Stein et al. 2009 as their cohort included adolescents. Adults over 65 years with LOC or amnesia are included in the strict and lenient criteria in 2003 version, but only included in the strict criteria in 2007 version.
- (b) Rule consists of four risk groups according to clinical characteristics, covering all severity of injury. Clinical characteristics from the two risk groups that predict need for a CT scan in patients with GCS 13–15 are presented here, taking the most inclusive definition where a characteristic is covered by more than one risk group.
- (c) Assume the most inclusive version of the rule used by Ibanez and Arkan.
- (d) Eligibility criteria are either the inclusion criteria of the derivation cohort or the patients the rule was intended for where there is no derivation cohort.
- (e) Not listed in Smits et al.
- (f) Not listed in Stiell et al.
- (g) Not reported in Rosengren et al.

- (h) Reported in Smits et al. as GCS 13–14.*
- (i) Reported in Fabbri et al. as GCS 14 or GCS < 14 at any point, signs of basal skull fracture only, any vomiting and LOC/amenia proviso not included for coagulopathy, age and mechanism of injury.*
- (j) Not reported in Fabbri et al.*
- (k) Not reported in Stein et al.*
- (l) Dangerous mechanism is a pedestrian struck by a motor vehicle, an occupant ejected from a motor vehicle or a fall from an elevation of ≥ 3 feet or five stairs.*
- (m) Rule defines four risk categories according to clinical characteristics for those with GCS 13–15. Category 0 is discharged, category 1 is recommended to have CT or radiography, and categories 2 and 3 are required to have CT scan. Clinical characteristics for the three groups that predict need for CT scan (categories 1, 2 and 3) are presented here, taking the most inclusive definition where a characteristic is covered by more than one risk category.*
- (n) Reported in Smits et al. as GCS 13–14.*
- (o) Sign emergency reported in Smits et al. 70 as GCS 13–14 at 4 hours post injury. Sign CT urgently reported as including LOC, PTA, external injury to the skull, unclear history and non-trivial mechanism of injury, which are listed as indications for skull radiography in the original rule.*
- (p) Reported in Smits et al. with the following differences: LOC time not defined, < 2 years not listed, all risk factors identified for CT mandatory version of the rule also listed for CT recommended version of the rule.*
- (q) Reported in Vos et al. as vehicle accident with initial speed > 64 km/hour, major auto deformity, intrusion into passenger compartment > 30 cm, extrication time from vehicle > 20 minutes, falls from > 6 m, rollover, auto–pedestrian accidents or motorcycle crash at speed > 32 km/hour or with separation of rider and bike.*

H.2.2 Child and infant rules

Table 21: Summary of studies reproduced from HTA: decision rules for children and infants with mild head injury, definitions of outcomes and reference standards

Study	Rule(s) tested	Definition of ICI	Reference standard used for ICI	Patients who had CT (n)	Definition of need for neurosurgery	Reference standard used for need for neurosurgery
Atabaki et al. 2008 ¹⁹	Atabaki et al. 2008 ¹⁹	ICI: subdural, epidural, subarachnoid, intraparenchymal and intraventricular haemorrhages as well as contusion and cerebral oedema	CT scan	1000/1000 (100%)	Neurosurgery, including craniotomy, craniectomy, evacuation or intracranial pressure monitoring	Medical record review (unclear when performed)
Buchanich 2007 ⁶⁷	Buchanich 2007 ⁶⁷	ICI: intracranial haematoma, intracranial haemorrhage, cerebral contusion and/or cerebral oedema	CT scan Follow-up questionnaire/ telephone interview	97/97 (100%)	NA	NA
Da Dalt et al. 2006 ⁹⁵	Da Dalt et al. 2006 ⁹⁵	ICI: identified on CT either at initial ER presentation or during any hospital admission or readmission	CT scan obtained at discretion of treating physician All children discharged immediately from ER or after short observation received a follow-up telephone interview approximately 10 days later. Hospital records were checked for readmissions for 1 month after conclusion of study	79/3806 (2%)	NA	NA
Dietrich et al. 1993 ¹⁰⁸	Dietrich et al. 1993 ¹⁰⁸	Intracranial pathology: epidural or subdural haematoma, cerebral	CT scan	166/166 (100%) 71/71 (100%) ^a	NA	NA

Study	Rule(s) tested	Definition of ICI	Reference standard used for ICI	Patients who had CT (n)	Definition of need for neurosurgery	Reference standard used for need for neurosurgery
		contusions or lacerations, intraventricular haemorrhage pneumocephaly or cerebral oedema, with or without skull fracture				
Dunning et al. 2006 ¹¹⁷	CHALICE ¹¹⁸ , RCS guidelines ⁴²⁹	Clinically significant ICI: death as a result of head injury, requirement for neurosurgical intervention or marked abnormalities on the CT scan	All patients treated according to RCS guidelines. This recommends admission for those at high risk and CT scan for those at highest risk Follow-up: all patients who were documented as having had a skull radiograph, admission to hospital, CT scan or neurosurgery were followed up	744/22,772 (3.3%)	NR	NR, assume as the same for ICI
Greenes and Schutzman 1999, 2001 ^{171,172}	Greenes and Schutzman 1999, 2001 ^{171,172}	Greenes and Schutzman 1999 ICI: acute intracranial haematoma, cerebral contusion and/or diffuse brain swelling evident on head CT Greenes and Schutzman 2001 ICI: cerebral contusion, cerebral oedema or intracranial haematoma	Greenes and Schutzman 1999 CT scan, follow-up calls, review of medical records Greenes and Schutzman 2001 CT scan	188/608 (31%). 73 symptomatic patients did not receive CT ^b 172/172 (100%)	NA	NA

Study	Rule(s) tested	Definition of ICI	Reference standard used for ICI	Patients who had CT (n)	Definition of need for neurosurgery	Reference standard used for need for neurosurgery
		noted on CT				
Guzel et al. 2009 ¹⁷⁸	Guzel et al. 2009 ¹⁷⁸	Positive CT scan: definition NR	CT scan	337/337 (100%)	NA	NA
Haydel and Schembekar 2003 ¹⁹⁵	NOC ¹⁹⁵	ICI on head CT: any acute traumatic intracranial lesion, including subdural epidural or parenchymal haematoma, subarachnoid haemorrhage, cerebral contusion or depressed skull fracture	CT scan	175/175 (100%)	Need for neurosurgical or medical intervention in patients with ICI on CT	All patients with abnormal CT scan admitted and followed until discharge
Kupperman et al. 2009 ²⁵⁸	Kupperman et al. 2009 ²⁵⁸	Clinically important brain injury: death from TBI, neurosurgery, intubation for > 24 hours for TBI, or hospital admission of two nights or more associated with TBI on CT. Brief intubation for imaging and overnight stay for minor CT findings not included	CT scans, medical records, and telephone follow-up. Those admitted: medical records, CT scan results Those discharged: telephone survey 7 to 90 days after the ED visit, and medical records and county morgue records check for those uncontactable	9420/25,283 (37.3%) ^c 2632/8502 (31.0%) ^c 2223/6411 (34.7%) ^c 694/2216 (31.3%) ^c	NR	NR for neurosurgery. Assume as for ICI
Oman 2006 ³⁶⁴ ; ^a Sun et al. 2007 ⁵⁰²	NEXUS II ³⁶⁴ , pilot PECARN ²⁵⁸	Clinically important/significant ICI: any injury that may require neurosurgical intervention, lead to rapid clinical deterioration, or result in significant long-term neurological impairment	CT scan	1666/1666 (100%) ^d 309/309 (100%) ^d 208/208 (100%)	NA	NA
Osmond et	CATCH ³⁷⁰	Brain injury	CT scan	NR	Neurosurgery:	NR

Study	Rule(s) tested	Definition of ICI	Reference standard used for ICI	Patients who had CT (n)	Definition of need for neurosurgery	Reference standard used for need for neurosurgery
al. 2006 ³⁷⁰			14-day telephone interview		craniotomy, elevation of skull fracture, intubation, intracranial pressure monitor and/or anticonvulsants within 7 days ^e	
Palchak et al. 2003 ³⁷⁵	Pilot PECARN ²⁵⁸	TBI identified on CT scan or TBI requiring acute intervention or intervention by one or more of: neurosurgical procedure, ongoing antiepileptic pharmacotherapy beyond 7 days, the presence of a neurological deficit that persisted until discharge from the hospital, or two or more nights of hospitalisation because of treatment of the head injury	CT or performance of intervention	1271/2043 (62.2%) 1098/1098 (100%) 194/194 (100%)	Need for neurosurgical intervention	NR
Quayle et al. 1997 ⁴⁰⁸	Quayle et al. 1997 ⁴⁰⁸	ICI: definition NR	CT scan	321/321 (100%)	NA	NA

CATCH, Canadian Assessment of Tomography for Childhood Injury; Cs, consecutive; Cv, convenience; NA, not applicable; NEXUS II, National Emergency X-Radiography Utilization Study II; NR, not reported; P, prospective; PECARN, Paediatric Emergency Care Applied Research Network; R, retrospective; RCS, Royal College of Surgeons; UCD, University of California–Davis rule.

(r) Dietrich et al.: large cohort was split into two separate cohorts of different ages.

(s) Greenes and Schutzman derived rule for asymptomatic subset of original cohort reported in Greenes and Schutzman, using only those with CT.

(t) Kupperman et al. report two separate cohorts of patients, with each cohort split into two groups of different ages.

(u) Oman and Sun et al. use a subset of the NEXUS II derivation cohort; all cohorts reported here are subgroups with overlapping patients.

(v) From Mehta.

Table 22: Decision rules for children and infants with mild head injury reproduced from HTA

Criteria	Atabaki et al 2008 ¹⁹	Buchanich 2007 ⁶⁷	Da Dalt et al 2006 ⁹⁵	Dietrich et al 1993 ¹⁰⁸	CHALICE ³⁷⁰	CATCH Medium risk ³⁷⁰	CATCH high risk ³⁷⁰	Greenes and Schutzman 1999 ¹⁷¹	Greenes and Schutzman 2001 ¹⁷²	Guzel et al 2009 ¹⁷⁸
Version of rule						Medium-risk factors	High-risk factors	Decision rule	Scoring system	
Eligibility criteria	<21 years all severity	<3 years, GCS 14-15	<16 years, all severity, some exclusions	>2 years to 20 years, all severity, some exclusions	< 16 years, all severity	< 16 years, GCS 13-15, with clinical characteristics	<16 years, GCS 13-15, with clinical characteristics	<2 years, all severity	Asymptomatic < 2 years	<16 years, GCS 13-15
Mental status	GCS <15		Abnormal GCS	GCS <15	Abnormal GCS <14 or GCS <15 if <1 year old			Depressed		
Focal/neurological status	Sensory deficit		Abnormal neurological examination	Focal neurological deficits				Abnormal vital signs indicating possible increased intracranial pressure or focal neurological findings		
Skull fracture	Defect or signs of basilar skull fracture		Clinical signs in risk area, skull base fracture		Clinical signs of skull fracture	Signs of basal skull fracture		Abnormal vital signs indicating possible increased intracranial pressure or focal		

Criteria	Atabaki et al 2008 ¹⁹	Buchanich 2007 ⁶⁷	Da Dalt et al 2006 ⁹⁵	Dietrich et al 1993 ¹⁰⁸	CHALICE ³⁷⁰	CATCH Medium risk ³⁷⁰	CATCH high risk ³⁷⁰	Greenes and Schutzman 1999 ¹⁷¹	Greenes and Schutzman 2001 ¹⁷²	Guzel et al 2009 ¹⁷⁸
								neurological findings		
LOC			Prolonged	LOC	LOC			LOC		LOC
Vomiting		Vomiting		Vomiting	Vomiting			Two or more		Vomiting
Age	<2 years								Risk factorc	
Amnesia			Persistent	For the event	Amnesia					PTA
Coagulopathy										
Seizures				Seizures	Seizures					Seizures
Visible injury		Scalp lacerations			Scalp trauma	Large boggy scalp haematoma			Scalp haematoma location and size ^c	
Behaviour		Inconsolable	Persistent drowsiness			b	Irritability on examination	Lethargy or irritability		
Headache		Persistent	Headache			b	Worsening headache			Headache
Previous neurosurgery										
Failure to improve						b	Failure to reach GCS 15 in 2 hours			
Mechanism of injury	Bicycle-related injury				High speed road traffic, or high	Dangerous				

Criteria	Atabaki et al 2008 ¹⁹	Buchanich 2007 ⁶⁷	Da Dalt et al 2006 ⁹⁵	Dietrich et al 1993 ¹⁰⁸	CHALICE ³⁷⁰	CATCH Medium risk ³⁷⁰	CATCH high risk ³⁷⁰	Greenes and Schutzman 1999 ¹⁷¹	Greenes and Schutzman 2001 ¹⁷²	Guzel et al 2009 ¹⁷⁸
					speed or fall >3 m					
Deterioration in mental status	Mental status change									
Other	Dizziness	Vision changes, gender, area of residence			Suspicion of non-accidental injury			Bulging fontanelle		Blurred vision

Table 23: Decision rules for children and infants with mild head injury reproduced from from HTA continued

Criteria	NEXUS II ³⁶⁴	NOC ¹⁹⁵	PECARN (>2 years to 18 years) ²⁵⁸	PECARN (<2 years) ²⁵⁸	Quayle et al 1997 ⁴⁰⁸	RCS ^a guidelines ⁴²⁹	UCD - neurosurgery ³ ₇₅	UCD – intervention or brain injury ³⁷⁵	UCD - TBI ³⁷⁵
Version of rule			≥ 2 years to <18	<2 years			Neurosurgery	Intervention or brain injury	TBI
Eligibility criteria ^b	All ages, blunt head trauma	5 – 17 years, GCS 15 with clinical characteristics , some exclusion	≥2 years to < 18 years, GCS 14-15, some exclusions (e.g. trivial injury)	<2 years, GCS 14-15, some exclusions (e.g. trivial injury)	<18 years, non-trivial injury (with clinical characteristics)	All severities and ages, ^a with additional protocol for children	<18 years, non-trivial head injury, with clinical characteristics , some exclusions	<18 years, not trivial head injury, with clinical characteristics , some exclusions	<18 years, GCS 14-15, non-trivial, with clinical characteristics , some exclusions
Mental status	Altered level of alertness		Altered	Altered	Altered		Abnormal ^c	Abnormal ^c	Abnormal ^c
Focal/neurological status	Neurological deficit				Focal neurological deficit		Focal neurological deficit		

Criteria									
Decision rule	NEXUS II ³⁶⁴	NOC ¹⁹⁵	PECARN (>2 years to 18 years) ²⁵⁸	PECARN (<2 years) ²⁵⁸	Quayle et al 1997 ⁴⁰⁸	RCS ^a guidelines ⁴²⁹	UCD - neurosurgery ³⁷⁵	UCD – intervention or brain injury ³⁷⁵	UCD - TBI ³⁷⁵
Skull fracture	Evidence of significant skull fracture	Clinically suspected skull fracture	Clinical signs of basilar skull fracture	Palpable or unclear	Signs of basilar skull fracture			Clinical signs of skull fracture	Clinical signs of skull fracture
LOC			LOC	LOC		LOC ^d			
Vomiting	Persistent	Vomiting	Vomiting			Persistent ^d	Vomiting	Vomiting ^e	Vomiting
Age	N/A to children (≥ 65 years)								
Amnesia						Amnesia ^d			
Coagulopathy	Coagulopathy								
Seizures		PTS							
Visible injury	Scalp haematoma	Trauma above the clavicles ^f		Scalp haematoma		Scalp laceration, bruise or swelling ^d Significant maxillofacial injuries ^d		Scalp haematoma in a child ≤ 2 years	Scalp haematoma in a child ≤ 2 years
Intoxication		Drug or alcohol							
Behaviour	Abnormal behaviour			Acting abnormally according to parent					
Headache		Headache	Severe			Persistent ^d		Headache ^e	
Previous neurosurgery									
Failure to									

Criteria									
Decision rule	NEXUS II ³⁶⁴	NOC ¹⁹⁵	PECARN (>2 years to 18 years) ²⁵⁸	PECARN (<2 years) ²⁵⁸	Quayle et al 1997 ⁴⁰⁸	RCS ^a guidelines ⁴²⁹	UCD - neurosurgery ³ 75	UCD – intervention or brain injury ³⁷⁵	UCD - TBI ³⁷⁵
improve									
Mechanism of injury			Severe ^g	Severe ^h		Violent ^d fall from >1m ⁱ or on to hard surface ⁱ			
Deterioration in mental status									
Other		Short term memory deficits ^j				Tense fontanelle ⁱ Suspected non-accidental injury ⁱ			

MVC, motor vehicle collision; RCS, Royal College of Surgeons.

- (a) RCS guidelines for all ages is in three parts: (1) Indications for referral to neurosurgeon and/or urgent CT: coma; deteriorating level of consciousness or progressive focal neurological deficit; fracture of the skull if with confusion, deteriorating impairment of consciousness, fits, or neurological symptoms or signs; open injury (depressed compound fracture of skull vault, base of skull fracture or penetrating injury); patient fulfils criteria for CT of the head within referring hospital but this cannot be performed within a reasonable time (e.g. 2–4 hours). (2) Indications for CT of the head prior to referral to neurosurgeons: full consciousness but with a skull fracture; fits without a skull fracture; confusion or neurological symptoms/signs persisting after initial assessment and resuscitation; unstable systemic state precluding transfer to neurosurgery, diagnosis uncertain; tense fontanelle or suture diastasis in a child; significant head injury requiring general anaesthesia. (3) Indications for referral to neurosurgeons after CT of the head: abnormal CT scan (after neurosurgical opinion on images transferred electronically) or normal CT scan but unsatisfactory progress.
- (b) Eligibility criteria are either the inclusion criteria of the derivation cohort or the patients for whom the rule was intended if there is no derivation cohort.
- (c) Abnormal mental status present if GCS < 15, if patient confused, somnolent, repetitive or slow to respond to verbal communication.
- (d) Indications for skull radiography in children. If skull radiograph is positive, CT required. Other indications for all ages also apply.a
- (e) Definition used by Sun et al.; high-risk vomiting, severe or progressive headache.
- (f) Contusions, abrasions, lacerations, haematoma, deformity, clinically suspected facial or skull fracture.
- (g) Severe mechanism defined as MVC with patient ejection, death of another passenger, or rollover, pedestrian or bicyclist without helmet struck by a motorised vehicle, falls of > 1.5 m, head struck by a high-impact object
- (h) Motor vehicle collision with patient ejection, death of another passenger, or rollover, pedestrian or bicyclist without helmet struck by a motorised vehicle, falls of > 0.9 m, head struck by a high-impact object.
- (i) Indications for skull radiography in infants. If skull radiograph is positive, CT required. Other indications for all ages also apply.a
- (j) Defined by persistent anterograde amnesia and normal GCS, to three-object recall.

H.3 Anticoagulation and antiplatelets

Table 24: Anticoagulation

Reference	Study type	Number of patients	Patient characteristics	Follow-up	Outcome measures	Effect sizes	Comments
Fabbri et al, 2005 ^{132,133} , Fabbri et al 2004 ¹³⁶	Retrospective diagnostic cohort	N=7955 All cases with mild head injury defined as all patients attending for acute injury of head, other than superficial injury to face, GCS 14 or 15, aged ≥ 10 years. 9,464 registered cases, 1509 excluded because: unclear if trauma primary event (559); unstable vital signs (239); GCS <14 (172); penetrating injuries (22); voluntary discharge (235); reattendance within 7 days (282)	Median age: 44 (IQR: 27-71) years. 736 patients: 10-18 years, 2497 patients: ≥ 65 years Median injury time to admission: 60 (IQR: 42-110) minutes GCS score =14 at ≥ 2 hours since injury in 529 cases Scan performed in 4168/4560 of cases according to Neurotraumatology Committee of the World Federation of Neurosurgical Societies (NCWFNS) proposal Scan performed in 2536/2733 of cases according to NICE guideline	7 days	Incidence of intracranial lesions (ICL)	542/7955	Source of funding: No commercial, financial or other relationships that might create a conflict of interest. High risk patients, which includes coagulopathy were managed with a strict 24 to 48 hour observation regardless of CT findings
				6 months for all patients with lesions	ICL in patients discharged without indication for CT scan who re-attended	9/7955	
					Coagulopathy patients with & without lesions (i.e. scanned according to NCWFNS proposal)	Lesion: 67/542 No lesion: 198/7413 OR: 5.1 (3.8-6.9)	
					Coagulopathy patients with loss of consciousness or amnesia with & without lesions (i.e. scanned according to NICE guideline)	Lesion: 42/542 No lesion: 140/7413 OR: 4.4 (3.1-6.2)	
					Coagulopathy patients with no loss of consciousness or amnesia with & without lesions (i.e. subtracted NICE guideline figures from NCWFNS proposal)	Lesion: 25/542 No lesion: 58/7413 OR: 6.1 (3.8-9.9) Calculated by NCGC	
					Coagulopathy as in independent factor associated with lesions in a multivariate analysis of all NCWFNS proposal factors	OR: 8.4 (5.5-12.6)	
					Coagulopathy as in independent factor associated with lesions in a multivariate analysis of all NICE guideline factors	OR: 4.8 (2.6-8.6)	
					Coagulopathy patients with & without lesions who would not have been scanned according to NICE guideline	Lesion: 16/40 No lesion: 50/461 OR: 5.48 (2.7-11.0)	

Table 25: Antiplatelets

Reference	Study type	Number of patients	Patient characteristics	Follow-up	Outcome measures	Effect sizes	Comments
Fabbri et al, 2010 ¹³⁸ Patients taken from the same dataset/register as Fabbri et al, 2005 ^{132,133} , and Stein et al, 2009 ⁴⁸⁴	Retrospective diagnostic cohort	N=14,288	Median age: 49 (IQR: 29-75) years. 5180 patients: ≥ 65 years; 3701 patients: ≥ 80 years.	7 days	Incidence of intracranial lesions (ICL)	880/14,288	Source of funding: No commercial, financial or other relationships that might create a conflict of interest.
		All cases with mild head injury defined as all patients attending for acute injury of head, other than superficial injury to face, GCS 14 or 15, aged ≥ 10 years.	Adherence to local protocol nearly complete with CT scan performed in 9056 of cases (63.6%).	6 months for all patients with lesions	Antiplatelet patients with & without lesions	Lesion: 180/880 No lesion: 1186/13,348 OR: 2.6 (2.2-3.1)	
		16,799 registered cases, 2511 excluded because: unclear if trauma primary event (1100); unstable vital signs (378); GCS <14 (302); penetrating injuries (33); discharge against medical advice (388); reattendance within 7 days (310)	Antiplatelet drugs recorded: platelet aggregation inhibitors treatment with aspirin 100 mg, ticlopidine 250mg, indobufen 200mg. Other anti-inflammatory drugs not considered. Clopidogrel excluded: not available at protocol set up and later regulatory limitations in Italy.		Antiplatelet drugs as in independent factor associated with lesions in a multivariate analysis	OR: 2.8 (2.0-3.9)	

H.4 Biomarkers

H.4.1 S100B

Table 26: Biberthaler 2001

Reference	Study type	Number of patients	Patient characteristics	Intervention and comparison (Index test and reference standard)	Outcome measures	Effect sizes	Comments
Biberthaler 2001 ⁴⁴	Prospective cohort. (derivation) Setting: Emergency department Country: Germany	N = 52 <u>Inclusion criteria:</u> Consecutive patients selected. Patients with history of isolated minor head trauma, a GCS score of 13 to 15 and at least one of the following: amnesia, loss of consciousness, nausea, vomiting vertigo or severe headache. <u>Exclusion criteria:</u> Patients with focal deficits	Male = 38 Female= 14 Interval between trauma and admission (mean \pm SEM) = 73.46 \pm 47 minutes Interval between trauma and sampling (mean \pm SEM) = 116 \pm 18.8 minutes	<u>Index test:</u> Blood samples taken at admission and processed to serum. S-100b in serum measured using an immunoluminometric assay (LIA-mat Sangtec; BykSangtec). Cut-off point for diagnosis = 0.1ng/ml. <u>Reference standard:</u> Spiral CCT scan were performed within 6 hours of injury. Radiological findings were defined as pathologic if intracranial haemorrhage, skull fracture, or diffuse brain swelling was detected. Concentrations of PMN elastase were taken as a general marker of trauma.	<u>Intracerebral injury</u> Sensitivity Specificity Positive predictive value Negative predictive value TP FP FN TN	100 40.5 40.5 100 15 22 0 15	<u>Source of funding:</u> Supported by the Deutsche Forschungs-Gemeinschaft, Sonderforschungsbereich 469 of the Ludwig-Maximilians University Munich. The author is a recipient of a postdoctoral grant from the Deutsche Forschungs-Gemeinschaft Bi

Reference	Study type	Number of patients	Patient characteristics	Intervention and comparison (Index test and reference standard)	Outcome measures	Effect sizes	Comments
					Positive CT	15/52 (28.8%)	675-1/1 Incomplete patients characteristics – no details of age or proportion of GCS 13 – 15.

Table 27: Biberthaler 2002

Reference	Study type	Number of patients	Patient characteristics	Intervention and comparison (Index test and reference standard)	Outcome measures	Effect sizes	Comments
Biberthaler 2002 ⁴⁵	Prospective (derivation) Setting: Emergency department Country: Germany	N = 104 (recruited over 18 months) <u>Inclusion criteria:</u> GCS = 13-15 At least one of: transient loss of consciousness (less than 5 mins), amnesia for the traumatic event, nausea, vomiting,	Male = NR Female= NR	<u>Index test</u> Blood sampling within 2 hours of traumatic event (before CT performed, venous blood taken, processed to serum and citrated plasma and stored at -80°C. Serum and plasma S-100B assessed using LIA-mat procedure (LIA-mat Sangtec 100: Byk-Sangtec Diagnostica) which requires a processing period of more than 3	<u>Posttraumatic lesions</u> Sensitivity Specificity Positive predictive value Negative predictive value	100% 46% 36% 100%	<u>Source of funding:</u> Supported by the Deutsche Forschungs-Gemeinschaft, Sonderforschungs-bereich 469 of the Ludwig-Maximilians University Munich. The author is a

Reference	Study type	Number of patients	Patient characteristics	Intervention and comparison (Index test and reference standard)	Outcome measures	Effect sizes	Comments
		vertigo and severe headache. <u>Exclusion criteria:</u> None reported.		hours or the LIAISON version (Byk-Sangtec Diagnostica) which provides data within approx 40 mins. Effective cut off level obtain through generating a ROC curve = 0.12ng/ml for serum (LIA-mat and LIASISON) and 0.15ng/ml (LIA-mat) and 0.18ng/ml (LIAISON) for plasma. <u>Reference standard</u> After physical and neurological examination CT scans were performed with additional bone window reconstruction using a high reconstruction kernel for the skull base. CT scans were judged by 2 independent radiologists and respective findings were stratified according to the classification of Marshall into CT+ (diffuse injury I-IV, evacuated mass lesion and nonevacuated mass lesion) and CT- (no pathological signs).	TP FP FN TN	24 43 0 37	recipient of a postdoctoral grant from the Deutsche Forschungsgemeinschaft Bi 675-1/1 and Bi 675-1/2 Patient selection not reported e.g. consecutive etc Incomplete patients characteristics – no details of age or proportion of GCS 13 – 15.
					Positive CT	24	
					Negative CT	80	

Table 28: Biberthaler 2006

Reference	Study type	Number of patients	Patient characteristics	Intervention and comparison (Index test and reference standard)	Outcome measures	Effect sizes	Comments
Biberthaler 2006 ⁴³	Prospective (Derivation) Setting: 3 level one trauma centers Country: Germany	N = 1309 <u>Inclusion criteria:</u> Consecutive patients with a history of isolated head trauma and admission within 3 hours; GCS score of 13 to 15 upon admission; and one or more of 10 clinical risk factors: brief loss of consciousness, post-traumatic amnesia, nausea, vomiting, severe headache, dizziness, vertigo, intoxication, anticoagulation, and age above 60 years. <u>Exclusion criteria:</u> Patients aged under 18, pregnant women, prisoners, and multiple-injured patients were excluded.	Median age: 47 (32 – 65) Male: 855 Female: 454 GCS 15: 1152 GCS 14: 122 GCS 13: 35	<u>Index test</u> Venous blood samples were processed to serum and deep frozen at -20°C until assay with an electrochemiluminescence immunoassay kit (Elecsys S100; Roche Diagnostics). According to manufacturers' instructions, the test system requires 18mins. ROC analysis was conducted to determine the discriminative ability of S100B measurements according to CT positive or negative findings. A cut-off level of 0.1µg/l was determined. <u>Reference standard:</u> All patients received a head CT scan. Negative scans: mild head injury patients without any signs of trauma-relevant intracerebral lesions. Positive CT scans: Mild head injury patients with at least one of the pathophysiological trauma-relevant findings (haemorrhage or cortex contusion).	<u>Intracerebral lesions</u>		<u>Source of funding:</u> Supported by Roche Diagnostics who supplied the diagnostic kits and managed the technical aspects of data accrual and storage.
					Sensitivity	99%	Additional data: Additional patients were recruited to the study as negative and positive controls.
					Specificity	30%	Negative control: healthy individuals without a history of head trauma acted as volunteer blood donors. N = 540 Positive control: patients with moderate to severe head injury n = 55.
					TP FP FN TN	92 1 855 361	
					CCT positive	93	
					Positive predictive value	10%	
					Negative predictive value	99.68%	

Table 29: Bouvier 2012

Reference	Study type	Number of patients	Patient characteristics	Intervention and comparison (Index test and reference standard)	Outcome measures	Effect sizes	Comments
Bouvier 2012 ⁵⁵	Prospective cohort (Validation) Setting: Paediatric emergency department. Country: France	N = 241 patients with mild head injury (65 received a CT and were included in the diagnostic accuracy calculations <u>Inclusion criteria:</u> All children (<16 years) with Mild TBI, GCS 13 - 15 on admission and 1 or more of clinical risk factors. Risk factors include: brief LOC, posttraumatic amnesia, nausea, vomiting, severe or progressive headache, dizziness, vertigo, intoxication, anticoagulation, skull fracture, seizure, age <2 years. <u>Exclusion criteria:</u> Pregnant women, children whose TBI occurred >3h before presentation, and multiply injured patients.	Male: Female = 1.68 Median age: 5.2 years (2.1 - 9.9 years)	<u>Index test</u> Venous blood sample taken within 3 hours were processed to serum and deep frozen at -80°C until assayed after being checked for instability. Serum S100B concentrations were determined by electrochemiluminescence immunoassay on a Roche Diagnostics Modular Analytics system E170 and performed in duplicate. Reference intervals were derived for 3 age groups: 0.35µg/L for 0 - 9 months 0.23µg/L for 10 - 24 months 0.18µg/L for >24 months Patients below the cut off were counted as S100B negative and those with concentrations above the as S100B positive. <u>Reference standard</u> CT scan using helical mode with a slice thickness of 2.25mm, interval of 1.25mm, 120kV, and a maximum of 280mA, from C1 to the top of the head, with additional bone window reconstructions. CCT negative patients had no signs of trauma relevant intracerebral	<u>Abnormalities on CT</u> Sensitivity Specificity Positive predictive value Negative predictive value TP FP FN TN	100% (85.2% - 100%) 33% (20% - 50%) 45% (31% - 60%) 100% (97% - 100%) 23 28 0 14	<u>Source of funding:</u> Paper states that the finding organisations played no role in the design of study, choice of enrolled patients, review and interpretation of data, or preparation of data, or preparation or approval of manuscript. <u>Limitations:</u> patient characteristics given for entire cohort and not just those receiving a CT scan (those included in the analysis)
					<u>CT positive findings</u>	Epidural haemorrhage (21.5%) Haemorrhagic contusion (14%) Bone fracture (18%) Subdural haemorrhage (11%)	

Reference	Study type	Number of patients	Patient characteristics	Intervention and comparison (Index test and reference standard)	Outcome measures	Effect sizes	Comments
				lesions and CCT positive patients had at least 1 pathophysiological trauma-relevant intracerebral lesion.		Othematoma (3%)	

Table 30: Calcagnile 2012

Reference	Study type	Number of patients	Patient characteristics	Intervention and comparison (Index test and reference standard)	Outcome measures	Effect sizes	Comments
Calcagnile 2012 ⁶⁸	Prospective cohort (Validation) Setting: Level II trauma centre, emergency department. Country: Sweden	N = 512 <u>Inclusion criteria:</u> Consecutive adult patients with mild head injury (acute trauma to the head with GCS 14 - 15 during examination and loss of consciousness <5 mins and/or amnesia, wit addition of the S100B sample). Patients with antiplatelet agents (such as aspirin or clopidogrel) were included.	S100B <10ug/L (n = 138) Male: 85 Female: 53 Mean age: 32.6 S100B ≥10ug/L (n = 374) Male: 229 Female:145 Mean age: 46.6 All Male: 314 Female:198 Mean age: 42.2	<u>Index test</u> 5ml blood sample was drawn from each patient's cubital vein in the ED. Samples were analysed with the automated Elecsys S100 (Roche AB). A cut of of 0.1ug/L and a window of sampling of 3 hours from the time of accident. Lab results were available to treating physicians within 1 hour of sampling. <u>Reference standard</u> CT scans were performed with a 64 multislice detector. 10mm thick slices were used. A CT scan was considered positive if any signs of cranial (skull fracture) or intracranial pathology (haematoma, air or contusion)	<u>Significant intracranial complications</u> Sensitivity Specificity Positive predictive value Negative predictive value TP FP FN TN	100% 28% 6% (4.2 - 10) 100% (97 - 100) 24 350 0 138	<u>Source of funding:</u> Funded with non-commercial (Swedish state) funds via the Scientific Committee at the Halmstad Regional Hospital and Region Skane, Sweden.

Reference	Study type	Number of patients	Patient characteristics	Intervention and comparison (Index test and reference standard)	Outcome measures	Effect sizes	Comments
		<p><u>Exclusion criteria:</u> Age less than 18 years, non-Swedish citizens (difficult to follow up), neurological deficits, additional risk factors from the SNC guideline: therapeutic anticoagulation or haemophilia, clinical signs of depressed skull fracture or skull base fracture, posttraumatic seizures, shunt-treated hydrocephalus and multiple injuries) and patients where serum sample for S100B was done more than 3 hours post-injury.</p>		<p>were present. In addition to CT a postal questionnaire was sent 3 months after the injury to identify any significant intracranial complications.</p>	<p><u>CT positive findings</u></p>	<p>24 (traumatic abnormalities: isolated skull fracture = 3, intracranial air = 1, combination of traumatic intracranial findings = 10). 2 patients showed CT pathology not related to trauma (cerebral tumour and pathological intracranial calcification). No patients required neurosurgical intervention. 1 patients died as a result of head injury.</p>	

Table 31: Castellani 2009

Reference	Study type	Number of patients	Patient characteristics	Intervention and comparison (Index test and reference standard)	Outcome measures	Effect sizes	Comments
Castellani 2009 ⁷¹	Prospective cohort (Validation) Setting: Paediatric Country: Austria	N = 109 <u>Inclusion criteria:</u> All patients under 18 who presented to hospital with mild traumatic brain injury (MTBI) after blunt head trauma were included after acquisition of informed consent. MTBI was defined as GCS of 13-15 at admission in combination with associated clinical symptoms (vomiting, loss of consciousness – and in patients > 4 persistent headache, retrograde amnesia and vertigo). <u>Exclusion criteria:</u> None reported	Male: 73 Female: 36 Mean age at admission: 9.5 years (SD 4.7) GCS 15: 86 GCS 14: 13 GCS 13: 10 32 were admitted to ICU	Index test Serum 100B was determined by sampling 1-3 ml of venous blood within 6 hours of trauma. The blood was allowed to clot for at least 30 mins, centrifuged and the serum was immediately analysed. An electrochemiluminescence immunoassay (Roche Diagnostics) on a Modular Analytics instrument was used for the analysis of serum S100B levels. Measurements and calibrations were as per manufacturers instructions. The upper reference of serum S100B was set to 0.16µg/L. Reference standard Cranial CT was performed in all patients, and was classified as pathological in the presence of a skull fracture or intracranial haemorrhage.	<u>Abnormalities on CT</u>		<u>Source of funding:</u> Not stated [109 patients selected from a cohort of 928 – differential verification bias]
					Sensitivity	100%	
					Specificity	42.5%	
					Positive predictive value	46%	
					Negative predictive value	100%	
					TP	36	
					FP	42	
					FN	0	
					TN	31	
					<u>Abnormalities on CT</u>	36 (30.3%)	

Table 32: Cervellini 2012

Reference	Study type	Number of patients	Patient characteristics	Intervention and comparison (Index test and reference standard)	Outcome measures	Effect sizes	Comments
Cervellini 2012 ⁷³	Prospective cohort (Derivation) Setting: Emergency department Country: Italy	N = 60 <u>Inclusion criteria:</u> Consecutive patients aged 14-80 years, presenting to the emergency department with a history of mild head injury and a GCS of 14-15 at presentation. Patients received a CT if met the local guideline used: loss of consciousness, peritraumatic amnesia, previous neurosurgical procedures, inherited coagulopathy or anticoagulant therapy, more than 1 episode of vomiting,	Male: 41 Female: 19 Mean age: 58 (14-80) Mean time from injury to sampling; 62mins	<u>Index test</u> Peripheral venous blood samples were collected within 3 h from injury shipped to the laboratory (within 30mins). Serum S100B levels were measured with a immunoluminometric sandwich immunoassay on Liaison (DiaSorin SpA). Detection limit: 0.02µ/L. ROC analysis was performed to determine diagnostic performance: cut-off = 0.38µ/L <u>Reference standard</u> CT interpretation was performed immediately after examination by an attending neuroradiologist. Any intracranial pathology associated with injury (acute subdural, epidural or parenchymal hematoma, traumatic subarachnoid haemorrhage, cerebral contusion and brain swelling) detectable on CT was	<u>Intracranial injury</u> Sensitivity Specificity Negative predictive value Positive predictive value TP FP FN TN	100% 58% 100% 54% 20 17 0 23	<u>Source of funding:</u> Not reported

Reference	Study type	Number of patients	Patient characteristics	Intervention and comparison (Index test and reference standard)	Outcome measures	Effect sizes	Comments
		<p>epilepsy or post-traumatic seizures, or worsening headache, drug or alcohol intoxication, clinical signs of depressed or basilar skull fracture or focal neurological findings.</p> <p><u>Exclusion criteria:</u> Patients with unknown time of injury or acute non-traumatic intracerebral lesions.</p>		considered positive. CT scans were reviewed by a senior neuroradiologist who was blinded to the conclusion of previous reading.	<u>Positive CT</u>	20/60	

Table 33: Egea 2012

Reference	Study type	Number of patients	Patient characteristics	Intervention and comparison (Index test and reference standard)	Outcome measures	Effect sizes	Comments
Egea 2012 ¹²⁵	Prospective cohort (Validation of Biberthaler 2006, and Derivation) Setting: Emergency department Country: Spain	N = 143 <u>Inclusion criteria:</u> Aged over 14, GCS = 15 at hospital admission and with one or more of the following: transitory loss of consciousness, amnesia, persistent headache, nausea or vomiting and vertigo. <u>Exclusion criteria:</u> Under 14 years of age, pregnancy, previous history of drug/alcohol abuse, renal failure, GCS below 15, hospital admission after 6 hours post-trauma, history of syncope or seizure before head trauma, other previous nervous system disorders, absence of post-trauma head CT, hospital discharge	Male: 89 (62.2%) Female: 54 (37.8%) Mean age: 49 (SD± 20.6) GCS 15: 143	<u>Index test</u> A 5ml venous blood sample was taken during the first 6 hours post trauma. Samples were processed to serum and stored at -80°C. Serum S100B protein levels were measured using an electrochemiluminescence assay (ECLIA, Elecsys 2010 immunoassay; Roche). Detection begins at 0.0005µgL ⁻¹ The biochemist and technician performing the assays were blind to clinical and radiological findings. ROC analysis provided an optimal cut-off for S100B. <u>Reference standard</u> A CT scan was performed within 24 hours of the accident. Neuroradiological findings were reviewed and classified by a neuroradiologist blind to study goals and data. Intracranial lesions were defined as cerebral contusion, traumatic subarachnoid haemorrhage, epidural haematoma and subdural	<u>Intracranial lesion</u> <u>Validation: S100B cut off of 0.105 µgL⁻¹</u> Sensitivity Specificity Positive predictive value Negative predictive value <u>S100B cut off of 0.105 µgL⁻¹</u> TP FP FN TN <u>Derivation: Intracranial lesion</u> <u>S100B cut off of 0.130 µgL⁻¹</u> Sensitivity	100 26.56 13.76 100 15 94 0 34 100	<u>Source of funding:</u> Protein S100B Electrochemiluminescence Assay Kits from Roche Diagnostics. [patients selected for inclusion rather than included consecutively]

Reference	Study type	Number of patients	Patient characteristics	Intervention and comparison (Index test and reference standard)	Outcome measures	Effect sizes	Comments
		before the first 24 hours post TBI and ICU admission/transfer due to associated severe extracranial lesions.		haematoma.	Specificity	32.81	
					Positive predictive value	14.85	
					Negative predictive value	100	
					<u>S100B cut off of 0.130 µgL⁻¹</u>		
					TP	15	
					FP	86	
					FN	0	
					TN	42	

Table 34: Morochovic 2009

Reference	Study type	Number of patients	Patient characteristics	Intervention and comparison (Index test and reference standard)	Outcome measures	Effect sizes	Comments
Morochovic 2009 ³²²	Prospective cohort (validation) Setting: Emergency department Country: Slovakia	N = 102 <u>Inclusion criteria:</u> Consecutive patients of all ages, who presented to the trauma emergency department with history of mild traumatic brain injury between December 2006 and December 2007. <u>Exclusion criteria:</u> Any patients with unknown time of injury or acute non-traumatic intracerebral lesions were excluded from the study. Patients with chronic intracerebral lesions were included to the study except suspected/visible brain tumour.	Male: 71 Female: 31 Mean age: 42.0 (SD 19.7 years, range 12 – 84 years) GCS 13: 3 (2.9%) GCS 14: 23 (22.5%) GCS 15: 76 (74.6)	<u>Index test</u> Peripheral venous blood samples were taken within 6 hours of injury and sent to the laboratory within 30 mins. Electrochemiluminometric immunoassay (Elecsys S100, Roche Diagnostics) was used to measure S100B serum protein concentration with a detection limit at 0.005ng/ml. S100B serum concentrations of 0.1 ng/ml or greater were considered positive for patients of all ages. Precision studies were carried out using commercial controls (PeciControls) provided by Roche Diagnostics. <u>CT scanning</u> Unenhanced CT scans were performed with Siemens Somatom Sensation Open scanner. CT scans were performed in all patients involved in the study within 30 mins of blood drawing. CT interpretation was performed immediately after examination by attending senior radiologist. First CT scan was reviewed by an experienced radiologist blinded to	<u>Intracranial injury (CT detectable)</u> Sensitivity Specificity TP FP FN TN Positive predictive value Negative predictive value	83.3% 29.8% 59 25 15 3 20% 89%	<u>Source of funding:</u> Supported by a the scientific grant agency of The Ministry of Education of the Slovak Republic and of The Slovak Academy of Sciences. Additional information given about the 3 cases of negative S100B and positive CT (epidural haematoma, traumatic subarachnoid haemorrhage and acute subdural haematoma).

Reference	Study type	Number of patients	Patient characteristics	Intervention and comparison (Index test and reference standard)	Outcome measures	Effect sizes	Comments
				<p>the result of the first interpretation</p> <p>Any intracranial pathology associated with an injury (acute subdural, epidural or parenchymal hematoma, traumatic subarachnoid haemorrhage, cerebral contusion and brain swelling) detectable on CT was considered positive.</p>	Positive CT	18/102	

Table 35: Muller 2011

Reference	Study type	Number of patients	Patient characteristics	Intervention and comparison (Index test and reference standard)	Outcome measures	Effect sizes	Comments
Muller 2011 ^{331,332}	<p>Prospective cohort (Validation)</p> <p>Setting: Emergency department</p> <p>Country: Switzerland</p>	<p>N = 233</p> <p><u>Inclusion criteria:</u> All patients, 16 or over, with mild head trauma (GCS 13-15) admitted to the emergency department were consecutively enrolled.</p>	<p>Median age: 48.4 years (IQR; 24-72)</p> <p>Male: 143 Female: 90</p> <p>Median time between admission to sampling: 77</p>	<p><u>Index test</u> Blood samples were collected from all patients and processed to serum and S100B levels were determined by electrochemiluminescence immunoassay on a Modular Analytics E411 (Elecsys S100, Roche Diagnostics). The S100B cut-off for the presence of relevant TBI was chosen as 0.105µg/l based on previous</p>	<p><u>Intracranial injury (reported)</u></p> <p>Sensitivity</p> <p>Specificity</p> <p>Negative predictive value</p> <p>Positive</p>	<p>86.4%</p> <p>12.2%</p> <p>85.7%</p> <p>12.8%</p>	<p><u>Source of funding:</u> None stated</p>

Reference	Study type	Number of patients	Patient characteristics	Intervention and comparison (Index test and reference standard)	Outcome measures	Effect sizes	Comments		
		<p><u>Exclusion criteria:</u> Patients suffering from cancer, stroke or other neurological diseases, or presenting with intracranial bleeds with a diameter >5mm or more than one bleed, a history of inherited coagulopathy or anticoagulant therapy, platelet aggregation inhibitor or intoxication were excluded.</p> <p>Patients were also excluded if they had late admission to the emergency department and/or multiple associated injuries.</p>	<p>min (IQR: 60-120) GCS: 15: 129 GCS 13-14: 10</p>	<p>studies (Biberthaler 2006) <u>Reference standard</u> All patients underwent a head CT scan (GE 64-row, multislice).</p>	predictive value				
								<u>Intracranial injury (calculated: error in paper)</u>	
								Sensitivity	86.4%
								Specificity	31.8%
								Negative predictive value	95.7%
								Positive predictive value	11.7%
				TP	19				
				FP	144				
				FN	3				
				TN	67				

Table 36: Mussack 2002

Reference	Study type	Number of patients	Patient characteristics	Intervention and comparison (Index test and reference standard)	Outcome measures	Effect sizes	Comments
Mussack 2002 ^{338,339}	Prospective cohort (Derivation) Setting: Emergency department Country: Germany	N = 139 <u>Inclusion criteria:</u> Patients consecutively admitted to a level 1 trauma center emergency department during the Oktoberfest in Munich from Sept – Oct 2000. Patients presented with a history of trauma, a GCS of 13-15 and showed at least one of: transient loss of consciousness (less than 5 mins), entero- or retrograde amnesia, nausea, vomiting or vertigo. <u>Exclusion criteria:</u> Patients who refused a cranial CT or blood drawing, or suffered concurrent injuries that precluded use of	Male: 106 Female: 33 Median age: 36 years (28.0 – 60.1) GCS 15: 129 GCS 14: 7 GCS 13: 3 Median serum alcohol concentration = 182 (59 – 235)	<u>Index test</u> Immediately after admission, two 5ml blood samples were taken from the cubital vein and processed to serum or plasma. S100B levels were analysed by immunoluminometric assay (LIAISON, Sangtec). Lower detection limit of 0.02ng/mL and a test performance time of 35min. NSE levels determined by electrochemiluminescence immunoassay (Roche Diagnostics, Elecsys). Lower detection limit of 0.01ng/mL and a test performance time of 20min. ROC analysis gave an optimal cut-off of S100B plasma of >0.21 ng/mL. ROC analysis gave an optimal cut-off of NSE of >12.28 ng/mL. Test results were reported to the emergency room at a median time of 55 min (48.6 – 60.2) after delivery of samples to the laboratory. <u>Reference standard</u> Cranial head CT was performed to detect relevant post-traumatic lesions such as skull fracture or	<u>S100B Post traumatic lesions</u> Sensitivity Specificity Positive predictive value Negative predictive value <u>S100B Post traumatic lesions</u> TP FP FN TN <u>NSE Post traumatic lesions</u> Sensitivity Specificity	100% 40% 24.1% 100% 19 60 0 60 100% 6.9%	<u>Source of funding:</u> None stated <u>Additional data:</u> Data from 20 healthy volunteers as a negative control. No statistical significance between S100B and serum alcohol concentration.

Reference	Study type	Number of patients	Patient characteristics	Intervention and comparison (Index test and reference standard)	Outcome measures	Effect sizes	Comments
		CT as well as those who did not report at least one of the inclusion criteria symptoms due to traumatic event were excluded.		subarachnoid haemorrhage, epidural or subdural haematoma, intracerebral haemorrhage, or diffuse brain oedema. All CT scans initially interpreted by radiologists on duty and were independently reviewed (blinded) by one staff radiologist and one CCT-experienced trauma surgeon.	Positive predictive value Negative predictive value <u>NSE Post traumatic lesions</u> TP FP FN TN <u>Positive CT</u>	24.1% 100% 32 100 0 7 19 (13.7%)	

Table 37: Polide-de-Figueiredo 2006

Reference	Study type	Number of patients	Patient characteristics	Intervention and comparison (Index test and reference standard)	Outcome measures	Effect sizes	Comments
Polide-de-Figueirdo 2006 ⁴⁰⁰	Prospective (validation) Setting: Emergency department Country: Brazil	N = 50 <u>Inclusion criteria:</u> Consecutive patients sustaining mild head injury (GCS 13-15) and presenting at least one of the following symptoms: amnesia, loss of consciousness, nausea, vomiting, vertigo, or severe headache on admission. <u>Exclusion criteria:</u> Patients with focal neurological deficits were excluded.	Male: 28 Female: 22 Age: Not reported GCS 15: 37 GCS 14: 11 GCS 13: 2 Median time from trauma to blood sampling = 82 mins	<u>Index test</u> Venous blood samples were drawn on admission and processed to serum. The deep frozen serum samples were transported to the Ludwig-Maximilians-University Hospital in Munich, and levels of S100B were measured using a newly developed heterogeneous immunoassay (Elecsys 2010) according to manufacturer's instructions. The cut off point used was 0.1µg/L, as determined from previous studies. <u>Reference standard</u> Cranial CT was performed within 6 hours of emergency room admission, and radiological findings were defined as pathological (CT+) if intracranial haemorrhage, skull fracture, and/or diffuse brain swelling were detected.	<u>Abnormalities on CT</u>		<u>Source of funding:</u> Supported by the program 'CAPES-BAVARIA', a project of the Bavarian ministry of science, research and art and the 'CAPES' administration in Brazil, grant number Z4-L0142B2-8/30321. Test systems were supplied by Roche Diagnostics. Additional information: a negative control group of 21 healthy volunteers was also studied.
					Sensitivity	100%	
					Specificity	20%	
					Positive predictive value	15%	
					Negative predictive value	100%	
					TP	6	
					FP	0	
					FN	35	
					TN	9	
					<u>Abnormalities on CT</u>	6	

Table 38: Zongo 2012

Reference	Study type	Number of patients	Patient characteristics	Intervention and comparison (Index test and reference standard)	Outcome measures	Effect sizes	Comments
Zongo 2012 ⁵⁴²	Prospective cohort (derivation) Setting: Emergency department (tertiary neurosurgical regional center) Country: France	N = 1560 <u>Inclusion criteria:</u> Consecutive patients 15 years or over presenting to the emergency department within 6 hours with minor head injury (GCS of 13 to 15), and with one or more risk factor: Loss of consciousness, posttraumatic amnesia, repeated vomiting, severe headache, dizziness, vertigo, alcohol intoxication, anticoagulation, and age older than 65 years. <u>Exclusion criteria:</u> Patients were excluded on admission if a severe injury was suspected (Abbreviated injury score >2). Patients	Male: 870 Age: (median and IQR) 57 (32-82) GCS 15: 1186 GCS 14: 335 GCS 13: 39	<u>Index test</u> Plasma was extracted from blood samples routinely taken in the emergency department and frozen at -20°C until assayed using an electrochemiluminescence immunoassay kit (Elecsys; Roche). ROC curve analysis determined the optimal cut-off of 0.12µg/L. <u>Reference standard</u> CT was performed within 6 hours after the head trauma with a Philips Brilliance CT. Trauma relevant lesions (subdural, epidural, or intracerebral haemorrhages; bland contusion; edema; pneumocephalus; and skull fracture) were searched for and coded by a resident in radiology and confirmed by a board certified radiologist, blinded to the S100B level.	<u>Intracranial injury</u> Sensitivity Specificity Negative predictive value Positive predictive value TP FP FN TN	99.1 19.7 99.7 8.6 110 1164 1 286	<u>Source of funding:</u> This study was funded by INSERM, the Reunica Group, and the teaching hospital of Bordeaux [Potential selection bias through a large amount of missing data (568 patients excluded from the analysis): S100B not available = 387, interval > 6 h = 95, no CT scan = 86]

Reference	Study type	Number of patients	Patient characteristics	Intervention and comparison (Index test and reference standard)	Outcome measures	Effect sizes	Comments
		with a nontraumatic neurologic disease and patients with a known history of motor neuron disease. Patients with > 6 hours between injury and blood sampling.					

H.4.2 NSE

Table 39: Fridriksson 2000

Reference	Study type	Number of patients	Patient characteristics	Intervention and comparison (Index test and reference standard)	Outcome measures	Effect sizes	Comments
Fridriksson 2000 ¹⁵²	Prospective pilot study Setting: Emergency department of an academic tertiary care children's hospital Country: USA	N = 49 <u>Inclusion criteria:</u> Patients presenting with blunt head trauma within 24 hours of injury and requiring head CT evaluation in accordance with the written ED practice guidelines. <u>Exclusion criteria:</u> Patients with penetrating head trauma, injury sustained more than 24 hours prior to presentation, or bleeding disorders.	Age: 2 months to 16 years Male: 27 Female: 22 Mean GCS: +CT for intracranial lesions (ICL)=11.9±4.2 -CT for ICL=13.9±2.6 Mean time from injury to blood sampling: +CT for ICL= 256 ± 310 min	<u>Index test</u> 5ml blood was drawn, spun and the serum frozen at -70°C. Serum NSE levels were determined using standard radio-immunoassay technique (Specialty Laboratories). The NSE reference range provided by Specialty Laboratories was undetectable (<10 ng/mL), indeterminable (10-15 ng/mL), and abnormal (>15 ng/mL). <u>Reference standard</u> CT scans were obtained on a GE high speed scanner at 5mm cuts for all patients. All CTs obtained were interpreted by one of four board-certified paediatric radiologists. Head CT was defined as positive for intracranial lesions when cerebral oedema, parenchymal bleeding, cerebral contusion, or subarachnoidal, subdural, or	<u>Intracranial lesions</u>		<u>Source of funding:</u> Supported by a grant from the Medical College of Wisconsin Clinical Research Center grant number 627. [method of patient selection not reported]
					Sensitivity	77%	
					Specificity	52%	
					Positive predictive value	57%	
					Negative predictive value	74%	
TP	17						
FP	13						
FN	5						
TN	14						

Reference	Study type	Number of patients	Patient characteristics	Intervention and comparison (Index test and reference standard)	Outcome measures	Effect sizes	Comments
			<p>-CT for ICL= 242 ± 147 min</p> <p>One patient was excluded from analysis because the blood sample was drawn 72 hours post injury.</p>	<p>epidural bleeding was identified.</p> <p>An ROC curve demonstrated that a level of ≥ 15.3 ng/mL yields the highest sensitivity and specificity for predicting ICL.</p>			

H.4.3 GFAP

Table 40: Papa 2012

Reference	Study type	Number of patients	Patient characteristics	Intervention and comparison (Index test and reference standard)	Outcome measures	Effect sizes	Comments
Papa 2012 ^{381,385}	Prospective controlled cohort (derivation) Setting: Emergency department Country: USA: 3 level 1 trauma centers.	N = 108 (117 with the additional 9 control patients who had a CT) <u>Inclusion criteria:</u> (convenience sample) Adult patients with suspected traumatic brain injury, determined by the treating physician according to the history of blunt head trauma followed by loss of consciousness, amnesia, or disorientation and presenting to the emergency department within 4	Mean age: 39 (SD: 15, range: 18-89) Male: 70%, 65/108 GCS 13 to 15: 97 GCS 9 to 12: 11 Average time to serum collection: 2.6h (95% CI: 1.9 to 3.2 h)	<u>Index test</u> Blood samples were obtained from each patient with traumatic brain injury and non-head-injured trauma control cohort shortly after arrival to the emergency department and within 4 hours of the reported time of injury. A single vial of 5ml of blood was processed to serum within 30 mins and frozen at -70°C until transported to a central laboratory. Samples were analysed using enzyme-linked immunosorbant assay to GFAP-break down products (Banyan-Biomarkers). Laboratory personnel were blinded to clinical information. ROC curves were generated to find optimal cut-off points. Cut off for intracranial lesions: 0.035ng/mL, cut off for need for neurosurgery: 0.17ng/mL	<u>Intracranial lesions on CT</u> Sensitivity	97%	<u>Source of funding:</u> Supported in part by the Department of Defence and the National Institute of Neurological Disorders and Stroke. Drs Liu, Mo, Zhang and Mondello and Ms Akinyi are employees of Banyan Biomarkers and Drs Wang and Hayes own stock, receive royalties from and are officers
					Specificity	18%	
					Positive predictive value	31%	
					Negative predictive value	94%	
					<u>CT positive</u>	32/108	
					TP	31	
					FP	70	
FN	1						
TN	15						

Reference	Study type	Number of patients	Patient characteristics	Intervention and comparison (Index test and reference standard)	Outcome measures	Effect sizes	Comments
		<p>hours of injury with a GCS score of 9 – 15.</p> <p><u>Exclusion criteria:</u> Patients were excluded if they were younger than 18 years; there was no history of trauma as their primary event (e.g. syncope or seizure; they had no known dementia, chronic psychosis, or active central nervous system pathology; or they were pregnant.</p>		<p><u>Reference standard</u> Patients underwent standard CT scan of the head according to the judgement of the treating physician. CT ordering was that that most patients with blunt head injury and with subsequent symptoms had a CT scan as part of usual care. CT scans were interpreted by board-certified radiologists, who recorded location, extent and type of brain injury. Radiologists were blinded to the study protocol, but had the usual clinical information.</p> <p>Intracranial lesions on CT defined as any acute traumatic intracranial lesion visualised on the CT scan.</p> <p>Neurosurgical intervention defined as either death within 7 days as a result of head injury or need for the following procedures within 7 days: craniotomy, elevation of skull fracture, intracranial pressure monitoring, or intubation for head injury.</p>	<p><u>Need for neurosurgical intervention</u></p> <p>Sensitivity</p> <p>Specificity</p> <p>Positive predictive value</p> <p>Negative predictive value</p> <p><u>Neurosurgical intervention</u></p> <p>TP</p> <p>FP</p> <p>FN</p> <p>TN</p>	<p>100%</p> <p>42%</p> <p>19%</p> <p>100%</p> <p>14/108</p> <p>14</p> <p>60</p> <p>0</p> <p>43</p>	<p>of Banyan Biomarkers.</p> <p>[Head CTs were performed at the discretion of the treating physician – not all patients received reference standard. An additional 9 controls were added to the analysis that had a head CT due to clinician judgement.]</p> <p>Additional information: Subgroup of normal adult volunteers (control group) and a group of non-head injured patients (single limb orthopaedic injury or after a</p>

Reference	Study type	Number of patients	Patient characteristics	Intervention and comparison (Index test and reference standard)	Outcome measures	Effect sizes	Comments
							vehicle crash without blunt head trauma).

H.5 Clinical decision rules for cervical spine imaging

H.5.1 Adults

Table 41: Bandiera 2003

Reference	Study type	Number of patients	Patient characteristics	Intervention and comparison (Index test and reference standard)	Outcome measures	Effect sizes	Comments
Banidiera ²⁵	Prospective observational cohort (validation) This is a sub study of Stiell 2001 ^{498,499} ; Phase 1 of the original derivation study. Setting: 10 Canadian urban teaching and community emergency departments	N = 6265 Patient selection not reported. In Stiell 2001 et al described as a convenience sample. <u>Inclusion criteria:</u> Ambulatory or immobilised adult patients who were hemodynamically stable (systolic blood pressure >90mmHg and respiratory rate between 10 and 24 breaths/min), were alert (GCS15) and had either neck pain from any mechanism of injury or no neck pain but some visible injury	Male: 3177 Age: 36.6 (SD 16) Radiographs performed: 4344 (69.3%) CT scan performed: 236 (3.8%) Cases followed up by telephone: 1956 (31.2%)	<u>Index test</u> Normal clinical assessment (prospectively to predict probability of c-spine injury - data not extracted) The Canadian C-spine rule was applied retrospectively <u>Reference standard</u> Plain radiography with or without flexion and extension views and CT imaging at the discretion of the treating physician. Patients who did not undergo radiography participated in a structured telephone interview by a study nurse 14 days after	Diagnostic accuracy of C-spine injury - C-spine rule Sensitivity Specificity TP FP FN TN Diagnostic accuracy of C-spine injury - Physicians judgment Sensitivity Specificity	100 (94 - 100) 44 (43 - 45) 64 3475 0 2726 92.2 (94 - 100) 53.9 (82 - 96)	<u>Source of funding:</u> Supported by peer-reviewed grants from the Medical Research Council of Canada and the Ontario Ministry of Health Emergency Health Services Committee. Additional information:

Reference	Study type	Number of patients	Patient characteristics	Intervention and comparison (Index test and reference standard)	Outcome measures	Effect sizes	Comments
	Country: Canada	above the clavicles, had not been ambulatory, and had experienced a dangerous mechanism of injury. <u>Exclusion criteria:</u> Age younger than 16 years, GCS < 15, unstable vital signs, time of injury more than 48 hours before assessment, penetrating trauma, acute paralysis, known vertebral disease, reassessment of the same injury and pregnancy.		discharge to determine patient outcome and search for undetected injuries. Clinically unimportant injuries were defined as isolated avulsion fracture of an osteophyte, isolated fracture of a transverse process not involving body or facet joint, isolated fracture of a spinous process not involving the lamina, and isolated compression fracture less than 25% of the vertebral body height.	Clinically important c-spine injury: (some patients had >1) Clinically unimportant c-spine injury	64 (1%) 16 (0.3%)	
					Fracture: Dislocation: Ligamentous instability: Developed neurologic deficit	76 (1.2%) 6 (0.1%) 5 (0.1%) 5 (0.1%)	
					Stabilising treatments: Admitted to hospital	69 (1.1%) (internal fixation: 14, Halo: 23, Brace 5, rigid collar: 27) 437 (7%)	

Table 42: Coffey 2011

Reference	Study type	Number of patients	Patient characteristics	Intervention and comparison (Index test and reference standard)	Outcome measures	Effect sizes	Comments
Coffey 2011 ⁸²	Prospective observational - Validation Setting: Emergency department of 2 hospitals Country: UK	N = 1420 <u>Inclusion criteria:</u> Neck pain following acute blunt trauma to the head and/or neck. No neck pain, non ambulatory and evidence of injury above the clavicle. Alert and stable (GCS >15) with normal vital signs). Ages over 16 and injury sustained within the previous 48 hours. <u>Exclusion criteria:</u> Patients under 16 years, no trauma to head and neck, ambulatory patients with no neck pain, minor head/facial injury and a low risk mechanism. Major trauma, GCS < 15. Injury occurred >48 hours previously, penetrating trauma, acute paralysis/paresis. Vertebral	Male: 716 Female: 704 Age: NR GCS 15: all patients C-spine radiography performed in 987 patients C-spine injury: Vertebral fractures: 5 Fracture dislocations: 3	<u>Index test</u> Canadian c-spine rule. Decision rule algorithm was appended to the recruited patient's notes by the triage nurse. Doctor's were instructed to record their findings and to order radiographs as they normally would, irrespective of the decision rule. <u>Reference standard</u> Radiography or follow up by telephone (14 days) by a study nurse using a validated proxy outcome tool. Patients were recalled for re-assessment if any of the following were present: moderate or severe neck pain, moderate or severe restriction of neck movement, ongoing use of a neck collar, the neck injury had prevented a return to their usual pre-accident activity. If re-assessment suggested the possibility of a significant cervical injury, further	Diagnostic accuracy of C-spine injury Sensitivity Specificity TP FP FN TN	100% (95% CI: 56 – 100) 43% (95% CI: 39-45) 8 807 0 605	<u>Source of funding:</u> This study was partially funded by the Special Trustees Fund of the University Hospital Nottingham. <u>Additional information:</u> There were 202 'indeterminate' cases, in which doctors did not evaluate the range of motion as required by the decision rule. Aim of study was to investigate if the Canadian c-spine rule would reduce the number of radiographs ordered, rather than validating the diagnostic accuracy. Data on mechanism of injury available. Study size large but, due to small incidence of c-spine injuries, this study is not statistically powered to validate the rule in this setting.

Reference	Study type	Number of patients	Patient characteristics	Intervention and comparison (Index test and reference standard)	Outcome measures	Effect sizes	Comments
		disease, returned for assessment. Pregnancy.		imaging was performed.			

Table 43: Duane 2011A

Reference	Study type	Number of patients	Patient characteristics	Intervention and comparison (Index test and reference standard)	Outcome measures	Effect sizes	Comments
Duane 2011A ^{114,115}	Prospective validation Setting: Level 1 trauma center Country: Virginia, USA	N = 3201 <u>Inclusion criteria:</u> All adults (>16 years) who suffered blunt trauma resulting in a trauma team activation. <u>Exclusion criteria:</u> None reported.	Patient characteristics reported by fracture/non-fracture Fracture Age: 42.7 ±19 years GCS 13.8 ±4.4 No fracture Age: 37.8 ±17.5 years GCS 14.4 ±4.3 192 patients had a total of 310 c-spine fractures.	<u>Index test</u> A data collection form was completed in the trauma bay in which all the answers to the Canadian cervical spine rule were documented on all patients. Only active rotation (45°) of the neck was excluded as part of the evaluation because the trauma facility felt it was too much of a risk for c-spine injury <u>Reference standard</u> All patients had a complete c-	<u>Diagnostic accuracy of C-spine fracture</u> Sensitivity Specificity Positive predictive value Negative predictive value TP FP FN TN	100% 0.06% 6.03% 100% 192 2991 0 18	<u>Source of funding:</u> None reported. Additional information: The authors conducted univariate analysis on the 30 clinical findings in the decision rule. Eight of these were identified as predictors of c-spine injury (tender to palpation)

Reference	Study type	Number of patients	Patient characteristics	Intervention and comparison (Index test and reference standard)	Outcome measures	Effect sizes	Comments
			Fractures: Vertebral body fractures: 94 Transverse process fractures: 69 Facet fractures: 61 Laminar fractures: 48 Spinous process fractures: 36 Other: 2	spine CT. CT was used to determine accuracy of clinical examination. A Siemens Sensation 16 multidetector CT was used in all patients. The scan extended from the base of the skull to the level of the third thoracic vertebra.			midline, GCS <15, Age \geq 65, parathesias, high speed motor vehicle collision (MVC), rollover MVC, patient ejection, never in sitting position in emergency department) Noted that the rule used was derived in a population of haemodynamically stable patients with GCS 15(population in this study has wider inclusion criteria)

Table 44: Griffith 2011

Reference	Study type	Number of patients	Patient characteristics	Intervention and comparison (Index test and reference standard)	Outcome measures	Effect sizes	Comments
Griffith 2011 ¹⁷⁴	Retrospective validation Setting: Emergency department of a level 1 trauma centre Country: Detroit, USA	N = 1552 (1589 examinations, 30 patients had multiple scans) <u>Inclusion criteria:</u> Retrospective review of patients older than 18 years and have search terms 'trauma, rule out fracture, motor vehicle accident or assault'. <u>Exclusion criteria:</u> Patient had no documented trauma despite indication given on CT, patient presented as an outpatient or an inpatient (i.e. not in emergency department), trauma >48 h before presentation, penetrating injuries, follow up examinations of a known fracture.	Male: 921 Female: 631 Age, mean: 43.4 (18-100 years) Mechanism of injury: Fall: 381/1589 Assault 477/1589 Motor vehicle crash: 599/1589 Pedestrian vs motor vehicle: 70/1589 Other: 62/1589 30 patients underwent multiple CT examination: 24 patients twice, 5 patients three times and one patient four times.	<u>Index test</u> NEXUS criteria were evaluated using emergency department documentation. The patient was considered to have normal mental status if they were documented to be alert and oriented to person, place, and time or if there was no documentation of GCS. In addition, information regarding paravertebral cervical tenderness and painful or decreased cervical range of motion was also collected – not part of NEXUS criteria, but reported here as 'liberalized NEXUS criteria'. <u>Reference standard</u> Radiologist confirmed fracture of any type, a dislocation or subluxation based on CT findings. Intermediate injuries were those in which a radiologist suggested a finding may be related to trauma or other cause and warranted further imaging to confirm findings.	<u>Cervical spine injury – NEXUS criteria, n = 1589</u>		<u>Source of funding:</u> Not reported. Additional information: Study not designed to test performance of NEXUS criteria (but to investigate if implementing NEXUS would lead to reduction in unnecessary CT scans).
					Sensitivity	90.2%	
					Specificity	23.8%	
					Positive predictive value	3%	
					Negative predictive value	98.0%	
					TP	37	
FP	1160						
FN	4						
TN	364						
Indeterminate CT with negative follow up	24						
<u>Cervical spine injury – liberalised NEXUS criteria, n = 1217</u>							
TP	37						
FP	1216						
FN	4						
TN	308						
Indeterminate CT with negative follow up	24						

Table 45: Hoffman 1992

Reference	Study type	Number of patients	Patient characteristics	Intervention and comparison (Index test and reference standard)	Outcome measures	Effect sizes	Comments
Hoffman 1992 ^{206,209}	Prospective observational cohort (derivation) Pilot NEXUS study Setting: UCLA emergency medicine center. Country: USA	N = 1000 (n = 974 cases, as 26 forms had incomplete data). <u>Inclusion criteria:</u> Consecutive patients. All patients with blunt trauma who underwent radiography of the cervical spine in a participating emergency department. <u>Exclusion criteria:</u> No exclusion criteria.	Male: 59.3% Median age (range): 25 (6 months - 98 years) 27 patients with c-spine fracture were admitted to the hospital during the entire study period.	<u>Index test</u> Prospective data collection forms were completed detailing history and physical examination, prehospital treatment, and estimated likelihood of cervical-spine injury. No specific attempt to modify physician use of cervical-spine radiography before, during, or after the study period. By combining data elements the authors identified most and in some cases all of the patients with fracture. <u>Reference standard</u> All patients received at least cross-table lateral, anteroposterior, and odontoid views, supplemented by oblique views, flexion-extension radiographs, and cervical CT as determined by emergency physicians.	<u>Diagnostic accuracy of C-spine injury</u> Midline neck tenderness or altered level of alertness Sensitivity Specificity NPV Midline neck tenderness or altered level of alertness or severely painful injury Sensitivity Specificity NPV Midline neck tenderness or altered level of alertness or severely painful injury or intoxication Sensitivity Specificity NPV	 93 (76 - 99) 50.6 (47.3 - 53.8) 99.6 (98.5 - 100) 96 (81 - 100) 41.8 (38.6 - 45.0) 99.7 (98.6 - 100) 100(87 - 100) 37.3 (34.2 - 40.4) 100 (99.0 - 100)	<u>Source of funding:</u> Not reported Additional information: Historical findings and signs and symptoms given for fracture and no fracture.

Reference	Study type	Number of patients	Patient characteristics	Intervention and comparison (Index test and reference standard)	Outcome measures	Effect sizes	Comments
				<p>The presence of fracture was confirmed by review of the final radiographic diagnosis of the ED studies as well as any additional studies performed in the inpatient setting.</p> <p>Preliminary diagnoses of 'no fracture' were confirmed by: reviewing quality assurance logs and risk management records and searching the diagnoses of discharged patients up to 3 months.</p>	<p>Any of midline neck tenderness or altered level of alertness or severely painful injury or intoxication or midline neck pain</p> <p>Sensitivity Specificity NPV</p>	<p>100 (87 - 100) 12.5 (10.4 - 14.7) 100 (96.9 - 100)</p>	
					<p>Any of midline neck tenderness or altered level of alertness or intoxication but exclude all patients with whiplash mechanism</p> <p>Sensitivity Specificity NPV</p>	<p>100 (87 - 100) 52.2 (48.9 - 55.4) 100 (99.3 - 100)</p>	

Table 46: Hoffman 2000

Reference	Study type	Number of patients	Patient characteristics	Intervention and comparison (Index test and reference standard)	Outcome measures	Effect sizes	Comments
Hoffman 2000 ^{206,208} methodology also Hoffman 1998 ^{206,210} Sub group analysis of patients aged >65 years old in Touger 2002 ⁵¹⁷	Prospective observational cohort (validation) Setting: 21 centers - university and community hospitals, varied in size and activity level in the emergency department. Country: USA	N = 34069 all patients (<65 = 30443, >65 years old = 2943) <u>Inclusion criteria:</u> All patients with blunt trauma who underwent radiography if the cervical spine in a participating emergency department. <u>Exclusion criteria:</u> Patients with penetrating trauma and those who underwent cervical spine imaging for any other reason, unrelated to trauma, were not eligible for inclusion.	Male: 58.7% Mean age (range): 37 (1 - 101) C-spine injury: Mean age (range): 40 (2 - 100)	<u>Index test</u> NEXUS criteria: no tenderness at posterior midline of cervical spine; no focal neurological deficit; normal level of alertness; no evidence of intoxication; and no clinically apparent, painful injury that might distract them from the pain of cervical spine injury. Patients who met all 5 criteria were considered to have a low probability of injury and not require radiographic or other imaging. At each center a physician in the emergency department served as a liaison to the study investigators and a dedicated radiologist ensured that data collection was complete and correct. Clinicians were trained in the NEXUS criteria and cautioned against using the set of criteria as the sole determinant of whether patients needed imaging.	<u>Diagnostic accuracy of Clinically significant C-spine injury</u> Sensitivity Specificity TP FP FN TN <u>Any injury (radiographically documented)</u> TP FP FN TN	all patients	<u>Source of funding:</u> Grant from the Agency for Healthcare Research and Quality. Additional information: Details of the 8 missed injuries given (including 2 with clinically significant injury - 1. no symptoms, but plain films showed a fracture of an anteroinferior portion of the second cervical vertebra. 2. plain film showed fracture of the right lamina of the sixth cervical vertebra and
						100% (99-100) 13% (13 - 13) 576 29184 2 4307	
						810 28950 8 4301	
					<u>Diagnostic accuracy of Clinically significant C-spine injury</u> Sensitivity Specificity NPV PPV	≥65 years olds 100 (97.1 - 100) 14.7 (14.6 - 14.7) 100 (99.1 - 100) 4.94 (4.94 - 5)	
					<u>Diagnostic accuracy of Clinically significant C-spine injury</u> Sensitivity	<65 years olds 99.6 (98.4 - 99.9)	

Reference	Study type	Number of patients	Patient characteristics	Intervention and comparison (Index test and reference standard)	Outcome measures	Effect sizes	Comments
				<p><u>Reference standard</u></p> <p>A standard set of 3 views of the spine was obtained in all patients, unless CT or MRI imaging of the entire spine was performed because plain film radiography was impractical or impossible. Other imaging studies could be ordered at the discretion of the treating physician.</p> <p>Injuries were defined as not clinically significant if they typically require no specific treatment and, if not identified, would be expected to result in no harm. Radiographically documented cervical spine injuries were categorised as not clinically significant if they were isolated and there was no evidence of other bony injury or ligamentous or spinal cord injury.</p>	<p>Specificity</p> <p>NPV</p> <p>PPV</p>	<p>12.7 (12.7 - 12.7)</p> <p>99.9 (99.8 - 100)</p> <p>1.6 (1.6 - 1.6)</p>	<p>fracture of the right clavicle).</p> <p>Noted that the decision instrument identified 2 patients with an odontoid fracture that was not initially diagnosed by the physicians.</p>
					<p><u>All patients:</u></p> <p>NPV</p> <p>PPV</p>	<p>99.8 (99.6 - 100)</p> <p>2.7 (2.6 - 2.8)</p>	
					<p><u>C-spine injury</u></p> <p>All patients</p> <p><65 years</p> <p>≥65 years</p>	<p>818</p> <p>683</p> <p>135</p>	
					<p><u>Fractures</u></p> <p>Occipital condyle</p> <p>C1</p> <p>C2 nonodontoid</p> <p>C2 odontoid</p> <p>C3</p> <p>C4</p> <p>C5</p> <p>C6</p> <p>C7</p>	<p><u>Aged <65</u></p> <p>18/30443</p> <p>79/30443</p> <p>141/30443</p> <p>51/30443</p> <p>44/30443</p> <p>78/30443</p> <p>160/30443</p> <p>219/30443</p> <p>220/30443</p>	<p>Touger et al 2002 did not provide sufficient data to calculate diagnostic 2x2 tables.</p>
					<p><u>Fractures</u></p> <p>Occipital condyle</p> <p>C1</p> <p>C2 nonodontoid</p> <p>C2 odontoid</p> <p>C3</p>	<p><u>Aged 65 and over</u></p> <p>2/2943</p> <p>26/2943</p> <p>52/2943</p> <p>40/2943</p> <p>6/2943</p>	

Reference	Study type	Number of patients	Patient characteristics	Intervention and comparison (Index test and reference standard)	Outcome measures	Effect sizes	Comments
					C4	6/2943	
					C5	17/2943	
					C6	23/2943	
					C7	27/2943	
					<u>Dislocation – subluxation</u>	Age < 65	
					Atlanto-occipital	5/30443	
					C1 – C2	15/30443	
					C2 – C3	20/30443	
					C3 – C4	22/30443	
					C4 – C5	33/30443	
					C5 – C6	53/30443	
					C6 – C7	46/30443	
					C7 – T1	9/30443	
					<u>Dislocation – subluxation</u>	<u>Aged 65 and over</u>	
					Atlanto-occipital	0/2943	
					C1 – C2	9/2943	
					C2 – C3	3/2943	
					C3 – C4	3/2943	
					C4 – C5	5/2943	
					C5 – C6	6/2943	
					C6 – C7	9/2943	
					C7 – T1	0/2943	
					<u>Spinal cord injuries</u>		
					Age < 65	61/30443	
					Age ≥65	8/2943	
					<u>SCIWORA</u>		
					Age < 65	22/30443	
					Age ≥65	5/2943	

Table 47: Stiell 2001

Reference	Study type	Number of patients	Patient characteristics	Intervention and comparison (Index test and reference standard)	Outcome measures	Effect sizes	Comments
Stiell 2001 ^{498,499}	Prospective observational cohort (derivation) Setting: 10 emergency departments in large community and university hospitals Country: Canada	N = 8924 <u>Inclusion criteria:</u> Convenience sample (stated in abstract) Consecutive (stated in methods) adult patients presenting to the ED after sustaining acute blunt trauma to the head or neck. Neck pain from any mechanism of injury or no neck pain but had all the following: some visible injury above the clavicles, had not been ambulatory, and had sustained a dangerous mechanism of injury. Alert (GCS 15), and stable (normal vital signs - systolic bp >90mmHg and a respiratory rate between (10 and 24/min). <u>Exclusion criteria:</u>	Male: 4600 (51.5%) Mean age: 36.7 years (range 16 - 98) C-spine radiography performed: 6145 (68.9%) CT scan performed: 436 (4.9%) Cases followed up by telephone: 2779 (31.1%) 577 excluded as they did not have C-spine radiography and were unable to be followed up. Time from injury to assessment, mean (SD): 4.5h(7.4)	<u>Index test</u> Derivation of Canadian C-spine rule. Univariate analyses were used to determine the strength of association between each variable and the primary outcome to aid selection of the best variables for the multivariable analyses. Those variables found to be both reliable ($\kappa > 0.6$) and strongly associated with the outcome measure ($P < 0.5$) were combined using either recursive partitioning or logistic regression. <u>Clinical variables included in the proposed rule:</u> Dangerous mechanism, age ≥ 65 , paresthesias in extremities, ambulatory at any time after injury, sitting position in ED, delayed onset of neck pain, absence of midline neck tenderness, able to rotate neck 45° left and right and simple rear-end MVC <u>Reference standard</u> Patients were subject to clinical examination and then plain radiography (minimum 3 views) of the c-spine according to the judgment of the treating physician. Additional flexion-extension views and CT of the c-spine were at the	Diagnostic accuracy of C-spine injury Sensitivity Specificity TP FP FN TN	100 (98 - 100) 42.5 (40.44) 151 5041 0 3732	<u>Source of funding:</u> Funded by peer-reviewed grants from the Medical Research Council of Canada and the Ontario Ministry of Health Emergency Health Services Committee. <u>Additional information:</u> 3281 eligible patients were examined, but not enrolled in this study by treating physicians.
					Clinically important c-spine injury Fracture Dislocation Ligamentous injury	151 143 (1.6%) 23 (0.3%) 9 (0.1%)	
					Developed neurological deficit	11 (0.1%)	
					Stabilising		

Reference	Study type	Number of patients	Patient characteristics	Intervention and comparison (Index test and reference standard)	Outcome measures	Effect sizes	Comments
		Younger than 16, had minor injuries, GCS <15, grossly abnormal vital signs, injured >48 hours previously, had penetrating trauma, presented with acute paralysis, had known vertebral disease, had returned for reassessment or were pregnant.		<p>discretion of the treating physician. Radiographs were interpreted by qualified staff radiologists who were blinded to the data collection sheet. All patients who did not have radiography had telephone follow up at 14 days. Patients were classified as having no clinically important c-spine injury if the met all criteria for 14 days: no or mild neck pain, no or mild restriction of head movement, use of cervical collar not required, neck injury has not prevented return to usual occupation activities.</p> <p>All c-spine injuries were considered clinically important unless the patient was neurologically intact and had one of the following: isolated avulsion fracture of an osteophyte, isolated fracture of a transverse process not involving body or facet joint, isolated fracture of a spinous process not involving the lamina, and isolated compression fracture less than 25% of the vertebral body height.</p>	<p><u>treatments</u></p> <p><u>Admitted to hospital</u></p>	<p>161 (1.8%) (internal fixation: 25, Halo: 55, Brace 19, rigid collar: 62)</p> <p>726 (8.1%)</p>	

Table 48: Stiell 2003

Reference	Study type	Number of patients	Patient characteristics	Intervention and comparison (Index test and reference standard)	Outcome measures	Effect sizes	Comments
Stiell 2003 ^{492,498}	Prospective observational cohort (validation) Setting: 9 emergency department Country: Canada	N = 8283 (3603 eligible patients were not enrolled by physicians, and another 635 had data forms but no outcome assessments). <u>Inclusion criteria:</u> Consecutive adults (\geq 16 years) with acute trauma to the head or neck who were both in a stable condition and alert and who had either neck pain or no neck pain, but met all of the following criteria: they had visible injury above the clavicles, were nonambulatory, and who had a dangerous mechanism of injury. GCS 15, normal vital signs and injury within the previous 48 hours.	Male: 4328 (52.3%) Age: 37.6 (\pm 16) CT scan performed: 5936 (71.7%) Cases followed up by telephone: 2338 (28.2%) Admitted to hospital: 430 (5.2%) Mean length of stay: 232.9 min(those who underwent radiography n = 4608) 123.2 min (did not undergo radiography n = 1997) Data reported excludes 845	<u>Index test</u> Canadian C-spine NEXUS low risk criteria Patients assessed by attending or resident emergency medicine physicians. Clinically important c-spine injury defined as: any fracture, dislocation, or ligamentous instability demonstrated by imaging. All injuries considered clinically important unless radiography showed; osteophyte avulsion, a transverse process not involving lamina, or a simple vertebral compression of less than 25% of body height. <u>Reference standard</u> Patients underwent standard plain radiography according to the judgement of the treating physicians. Additional views and investigations were ordered at the discretion of the treating physician.	Canadian C-spine - diagnostic accuracy of C-spine injury Sensitivity Specificity TP FP FN TN NEXUS - diagnostic accuracy of C-spine injury Sensitivity Specificity TP FP FN TN	99.4 (96 - 100) 45.1 (44 - 46) 161 3995 1 3281 90.7 (85 - 94) 36.8 (36 - 38) 147 4599 15 2677	<u>Source of funding:</u> Supported by peer-reviewed grants from the Canadian Institutes of Health Research and the Ontario Ministry of Health Emergency Health Services Committee. Additional information: Mechanism of injury reported.

Reference	Study type	Number of patients	Patient characteristics	Intervention and comparison (Index test and reference standard)	Outcome measures	Effect sizes	Comments
		<p><u>Exclusion criteria:</u> Under 16; had penetrating neck trauma, acute paralysis, or known vertebral disease; had been evaluated previously for the same injury; or were pregnant.</p>	<p>cases classified as indeterminate and (omitted from the analysis). Indeterminate defined as: physicians did not evaluate range of motion as required by the Canadian c-spine rule</p>	<p>All patients with an identified injury had a CT scan. Patients who did not have radiography underwent telephone follow up at a4 days. Patients were recalled for radiography if they did not meet any of the following: mild neck pain or none, mild neck-movement restriction or none, neck collar not used, and a return to usual occupation activities.</p>	<p><u>Clinically important c-spine injury</u> Fracture Dislocation Ligamentous injury</p> <p><u>Stabilising treatments</u></p>	<p>169</p> <p>209 71 8</p> <p>(internal fixation: 44, Halo: 45, Brace 13, rigid collar: 81)</p>	

H.5.2 Children

Table 49: Pieretti 2009

Reference	Study type	Number of patients	Patient characteristics	Intervention and comparison (Index test and reference standard)	Outcome measures	Effect sizes	Comments
Pieretti 2009 ³⁹⁹	Retrospective, derivation and validation. Setting: 22 trauma centres. Country: USA/Canada/Brazil	N = 12882 Included = 12537 (345 excluded that died at the emergency department) <u>Inclusion criteria:</u> Patients younger than 3 years who sustained blunt trauma during a 10 year period. No universal cervical spine clearance protocol was used across the study sites. 5 predominantly used physical examination, 6 depended on plain films and 11 used CT scans liberally. <u>Exclusion criteria:</u> Patients older than 36 months	Male: Not reported Female: Not reported Age: Not reported 83 confirmed patients with c-spine injury (by plain film and CT). Imaging: Plain radiograph: 4046 CT: 3358 MRI: 478	<u>Index test</u> PEDSPINE = Sample split into 2 cohorts, the first to derive clinical predictors for a protocol and the second (n = 4179) to validate the protocol. Multiple logistic regression analysis was used on the first cohort to identify 4 independent predictors of cervical spine injury (GCS <14, GCS EYE = 1, motor vehicle collision, and age >2 years i.e. 24 – 36 months). A weighted score was developed based on the magnitude of effect of predictor. GCS <14: 3 GCS _{EYE} = 1: 2 motor vehicle collision: 2 age >2 years: 1 <u>Reference standard</u> Cervical spine injury was defined as osseous or ligamentous injury to the c-spine seen on CT, radiograph or MRI.	<u>Diagnostic accuracy of C-spine fracture (weighted score of 0 or 1)</u> Sensitivity Specificity	92.9 69.9	<u>Source of funding:</u> Supported by a grant from the American Association for the Surgery of Trauma Foundation and a grant by Anthem Blue Cross/Blue Shield of Connecticut. <u>Additional information:</u> Patient characteristics not reported, only given for no injury vs injury.
					Positive predictive value Negative predictive value	Not reported 99.93	
					Derivation set TP FP FN TN	28 1224 2 2925	
					Validation set TP FP FN TN	50 2524 3 5777	

Table 50: Viccellio 2001

Reference	Study type	Number of patients	Patient characteristics	Intervention and comparison (Index test and reference standard)	Outcome measures	Effect sizes	Comments
Viccellio 2001 ⁵²⁷ .	Prospective, validation. Subgroup of NEXUS validation Hoffman et al 2000 ^{206,208} . Setting: Multicenter, mix of community hospitals, academic medical institutions, tertiary care facilities, trauma centres and children's hospitals. Country:	N = 3065 (NEXUS cohort = 34069) <u>Inclusion criteria:</u> Patients who underwent radiographic evaluation. Subgroup = patients <18. <u>Exclusion criteria:</u> Patients with penetrating trauma and those who underwent cervical spine imaging for any other reason, unrelated to trauma, were not eligible for inclusion.	Male: Female Age: <2 = 88 2 - 8= 817 9 - 17= 2160 Intoxication = 110 patients	<u>Index test</u> NEXUS low risk criteria: No tenderness at posterior midline of cervical spine; no neurologic abnormality; normal level of alertness; no evidence of intoxication; and no clinically apparent, painful distracting injury. Patients who met all 5 criteria were considered to have a low probability of injury and not require radiographic or other imaging. All patients underwent clinical evaluation prior to radiography, unless the patient was judged to be too unstable prior to radiography. The decision to radiograph was at the physicians discretion and nor driven by the NEXUS criteria. At each center a physician in the emergency department served as a liaison to the study investigators and a dedicated radiologist ensured that data collection was complete and correct.	<u>Diagnostic accuracy of C-spine fracture</u> Sensitivity Specificity Positive predictive value Negative predictive value TP FP FN TN <u>Clinically important c-spine injury</u>	100 (87.8 - 100) 19.9 (18.5 - 21.3) 1.2 (0.8 - 1.8) 100 (99.2 - 100) 30 2432 0 603 30	<u>Source of funding:</u> Funded by a grant from the Agency for Healthcare Research and Quality <u>Additional information:</u> Characteristics and prevalence of NEXUS criteria for patients who sustained cervical spine injury. 24/30 were clinically stable, 21/30 were male. No incidence of SCIWORA, >1

Reference	Study type	Number of patients	Patient characteristics	Intervention and comparison (Index test and reference standard)	Outcome measures	Effect sizes	Comments
	USA			<p>Clinicians were trained in the NEXUS criteria and cautioned against using the set of criteria as the sole determinant of whether patients needed imaging.</p> <p><u>Reference standard</u></p> <p>Radiographic imaging used a minimum of 3-view examination, including cross-table lateral, anteroposterior, and open mouth odontoid views. Other imaging studies, including CT, were ordered at the discretion of the treating physician.</p> <p>Injuries were defined as clinically significant based on the final interpretation of all radiographic studies (including CT/MRI).</p>			non-low-risk finding in 13/30 - full details for entire NEXUS cohort given, not just paediatric.

H.6 Patient information and discharge advice

H.6.1 Qualitative studies

Table 51: Falk 2008

Study	Falk 2008 ¹³⁹	
Aim	To identify information needs of the family when a child is hospitalised with mild head injury.	
Population	Families of 57 children (0-15 years) who visited the ED as a result of mild head injury with reported postconcussional symptoms (such as headache, fatigue or nausea) and children admitted to a hospital ward for observation. Country – Sweden.	
Methods	Follow up questionnaire contained one open-ended question ' what questions did you have when your child had injured his/her head'? - mailed to the families 3 months after the injury. Date of interview: March 2003 - June 2003	
Analysis	The answers received were subjected to content analysis. Text was coded and organised into categories. Repeated checks of the entire transcript were performed to ensure no changes from the original text were made.	
Themes with findings	Need for information concerning the head injury	Need for immediate information regarding the head injury. The family needed the health-care staff to treat their child on the basis of their professional observations, as well as to inform the entire family of the results of these observations, e.g. "Is this a concussion?". In addition, they wanted to be informed of the acute management strategy e.g. "What investigations are you planning to perform?". Furthermore, they wanted to know what the immediate complications might be "Could it be a brain injury? Is there any bleeding in the brain or fracture of the skull?".
		Need for information concerning everyday care. The family wanted to know information concerning daily care of their child at home, "What should we be aware of?", "What should we look for in particular when we are at home?.
		They also wanted information about the recovery process, "For how long will he/she feel like this?" and possible restrictions on the educational and other activities of their child "How active should I let my child be?", " How about watching television, reading, computer games and physical activities – what is he/she allowed to do?
	Need for reassurance and support	Need for reassurance and support for coping. The families had questions concerning the recovery of their child "Will he/she recover" and sought reassurance, "Will he/she get well?". They also wanted to know about any long-lasting consequences of the injury "Will there be any long-lasting consequences?". In addition, the parents of children less than 5 years of age asked questions like "Will this injury lead to a delay in physical development?" that were not asked by parents of older children.

Study	Falk 2008 ¹³⁹
	Need to share the emotional burden. The families expressed a need to share aspects of their emotional burden, describing feelings such as “I was so scared!”, anxiety and overall concern about the situation. They also sought assurance about possible guilt regarding their own management of their child’s injury with questions like “Should we have come to the hospital by ambulance?” and “Should we have come to the hospital sooner?”.
Limitations	<ul style="list-style-type: none"> • Uncertain if needs expressed are those of the child and/or parent. • Use of single-open ended questions may have limited the range of answers received, authors note that interviews may have provided richer and more varied information. • Information requested at 3 months post head injury, some families may have forgotten questions they had at the time of injury.

Table 52: Gagnon 2008

Study	Gagnon 2008 ¹⁵⁶
Aim	To identify specific needs of adolescents after a mild TBI.
Population	Adolescents (12 - 16 years) with mild TBI (according to WHO criteria, including GCS 13 - 15 after 30 mins post-injury or less), not due to drugs, alcohol, medication, caused by other injuries or problems. Patients selected from databases of the TBI programmes and emergency department of 2 paediatric trauma centres. 15 adolescents (5 girls, 10 boys) and 13 mothers and 2 fathers. These patients were separated into 3 groups, 1) Adolescents seen solely in the emergency department (n = 6), 2) Adolescents who were admitted to hospital for less than 24 hours for observation and referred to the TBI programme of the institution (n = 4), 3) Adolescents who were admitted to hospital (1 – 6 days) and required rehab services from a specialised TBI team because of the complexity of their injury or persisting symptoms (n = 5). Country – Canada.
Methods	<p>Individual semi-structured in-depth interviews were completed with each adolescent and at least one parent (separately) in their home. Interviews lasted 45-60 mins and conducted in their language of choice (English or French) by the same interviewer. An interview guide, comprised of open-ended questions designed to promote interaction between participants and the interviewer, was used.</p> <p>Interview did evolve over the course of the study, but the following themes were always discussed:</p> <p>The impact of the mild TBI on the various spheres of the adolescent's life (social, academic, leisure/physical activities), needs following a mild TBI during adolescence, the quality of services received since their injury and any additional services they wish they had received to ensure optimal recovery.</p>
Analysis	Interviews were audiotaped and transcribed. Information regarding injury was extracted from medical notes. Interviews were coded to identify key elements emerging from data. A preliminary coding frame was created, revised and refined allowing themes to emerge and categorisation of data in a structured manner.
Themes with findings	<p>Recovery from a mild TBI (related to impairments, activity limitations and</p> <p><u>Need to seek care after mild TBI.</u> Need for pain management and how to manage other symptoms e.g. headaches, nausea or irritability. Impairments such as postconcussion symptoms or loss of consciousness. Group 3 adolescents expressed needing management of more symptoms (dizziness, fatigue, sensitivity to noise, irritability) and indicated</p>

Study	Gagnon 2008 ¹⁵⁶	
	participation restrictions secondary to the mild TBI).	<p>they were not always met and needed multiple visits to the emergency department or physician. "...Basically all I wanted was to get rid of the headaches, they were so bad and everything they gave me it wouldn't work. So I went back to the hospital and I stayed there for a couple of nights. I was hoping for them to find something to give me to get rid of the headaches but nothing was working". (group 3 adolescent) "...I went to school the next day and I had really bad headaches the whole day and I was like crying in class it hurt so much, so that night I went to the hospital..." (group 1 adolescent)</p> <p><u>Need to obtain an accurate and prompt diagnosis.</u> Participants found the waiting times in the emergency department unacceptable, adolescents and parents considered a blow to the head to be a serious condition.</p> <p><u>Activities and participation.</u> Adolescents expressed a strong desire to reintegrate into their milieu and to return to their familiar surroundings and activities as soon as possible. They were worried that postconcussion symptoms could prevent their return to physical activities. As part of discharge they were advised that they should only return to physical activities once symptoms had resolved.</p>
Information		<p><u>Need for information following mild TBI.</u> Adolescents and parents felt that information should be readily available and that professionals should address adolescents directly and not only the parents.</p> <p><u>Information was requested about circumstances of the injury – what happened?</u> Adolescents looked for explanations from their families or professionals. For parents, it was their absence at the time of injury or at the time their teen was brought to hospital that created the need to find out about the circumstances of the injury. "What state was he in when he got there, did an ambulance bring him in, I don't know. I put the pieces back together afterwards, you don't know what's going on and it seems like nobody can...I don't know if I arrived during a change of shifts...The more I think about it the more you say to yourself, is somebody going to be able to tell me what happened..." (group 1 parent)</p> <p><u>Information was requested about mild TBI– what to expect?</u> All adolescents expressed the need to know as much as possible about the nature of their injury, sequelae and recovery. All parents wanted to know what to expect later and to be reassured about the condition. Parents sought information from sources other than the initial contact with the healthcare system even if it was from less reliable sources e.g. internet or friends. Parents also wanted to know about the type and level of care needed at home to facilitate recovery. "...When it first happened all I basically wanted to know was how bad my head injury was. Because I have had so many concussions I was really worried because the doctors always said don't hit your head again, because it could be the last time. And so I was really worried about that. And the headaches, I wanted them to go away (group 3 adolescent) "...well I guess it would have been nice if they could've had some kind of a handout I guess with different degrees and different symptoms and maybe what to do like I said, a list with symptoms and possible solutions..." (group 1 parent)</p> <p><u>Information was requested about return to activities – what can I do now?</u> Adolescents in groups 1 and 2 mainly wanted to know about return to physical activities following a mild TBI, whereas group 3 wanted this information,</p>

Study	Gagnon 2008 ¹⁵⁶	
		<p>but expressed a fear of poor performance. Group 3 wanted reassurance and wanted more information on adjustments for return to school after their absence and what was required for a smooth return. "I wanted to know and he only said...no he didn't say anything. He said I was ok to go back to school, and I went back...and that's all" (group 3 adolescent) "Not right away, about 2 months later. Because I didn't want to go back. I asked and they said that it would be better for me not to go back, that I shouldn't go back but I went back, but you know the team knows if there's something I don't want to do, well I just don't" (group 3 adolescent)</p> <p><u>Information was requested about return to activities – what can my teen do now?</u> Parents of group 1 and 2 adolescents expressed a need for information regarding return to school, over 75% wanted details on how to facilitate their adolescents return to school. All groups were worried about the impact of the injury on the child's academic performance. All parents required information on return to physical activity, with group 3 being particularly concerned. Group 3 also wanted information on prevention of future injuries. "...maybe what to do especially seeing as to how she's a hockey player and she's gonna have recurrent situations like this, I guess it would have been nice to have something that says you know what to look out for, what to do..." (group 1 parent) "But she had a lot of problems like I said, she doesn't compete anymore, it really stopped her...She only did dances and she taught smaller kids. It really affected her a lot... That's the problem because she looks like she's ok but there are a lot of things she doesn't do anymore. She did double jumps, she doesn't anymore, she's afraid of falling so she cut that completely..." (group 3 parent)</p>
	Support	<p><u>Support from family and friends.</u> Adolescents reported the need to feel secure from injury throughout their care and to receive support from people they felt comfortable with (friends and family). Parents expressed wanting to be close to their teenager and wanted professionals to facilitate their presence. "I didn't understand, I really needed my mom there, she was there, she stayed with me all week, she slept on a rocking chair beside me. I don't know, I just needed to be comfortable...I wasn't ok, I didn't understand, I just needed to feel safe and all, I was scared, I was in pain, I didn't understand (group 3 adolescent). "I didn't want to leave her, I didn't want her if something happened, but I wanted to be with her at home. I didn't want to leave her and go to work (group 2 parent).</p> <p><u>Support from professionals.</u> Adolescents in all groups wanted a trusting relationship with professionals (healthcare/teachers etc). Groups 1 and 3 spoke about support when returning to school and physical sport. "...It was really hard. I was so hard to concentrate because the headaches got worse. And so I was only going to school for half of the day. And when I was in class, I was really tired, I got bad headaches...The teachers did not help at all.".... Parents expressed the need for a post admission follow-up and the name and telephone number of someone they could contact if needed. "...You don't even have a name, you have the same paper for everyone, no doctor's name, no paper for school...that is, I would have liked to have a sheet that...that date, mild traumatic brain injury, the doctor that was seen, the hospital. After...I didn't even know the doctor's name so in that was it was pretty anonymous." (group 1 parent). Some of the teens in group 2 reported receiving a follow-up telephone call and their parents stated that this met their need for support post-hospitalisation.</p>

Study	Gagnon 2008 ¹⁵⁶	
		<p><u>Support from community partners.</u> Participants reported that services in the community were lacking and they wanted schools and sports providers to be more knowledgeable about their injury and how to support them. Suggestions for school included allowing gradual return and extra time for assignments. “The teachers, they could have probably, they could have understood what happened, they could have given me more time to hand in my work....They were getting mad at me because I was missing half days of school...” (group 3 adolescent).</p> <p>The need for a more formal link between the healthcare system and school systems or team coach was also discussed. “We monitor them...Where I would have noted something...I would have liked a link between...the hospital and schools in a certain way. If there was for example a programme that was there for cases like this...” (group 3 parent)</p>
	Specificity of adolescents	Adolescents expressed the need to exert some control over the situation (either during hospital stay or when receiving care from their parents). Specific needs included for professionals to address them directly and appear genuinely interested in them, and not only their injury. Need for professionals to develop appropriate and timely communication with their teachers and high school to facilitate a progressive and smooth return to academic activities.
Limitations		

Table 53: Keenan 2010

Study	Keenan 2010 ²⁴²	
Aim	To identify needs of individual family members of a relative with severe TBI and to determine if those needs change over time.	
Population	25 family members associated with 15 patients. Family members of patients aged 16 to 65 with severe TBI, as identified by GCS of 9 or less within first 24h and post traumatic amnesia in excess of one week. Country – Canada.	
Methods	<p>Semistructured interviews over 2 time periods. Time 1 = in acute care within 4 days of the patient having transferred out of ICU. Time 2, discharge from acute care occurred primarily in the same setting, or in rehab or complex care settings, within one week of discharge.</p> <p>3 open ended questions were asked:</p> <ul style="list-style-type: none"> • Can you tell us what it’s been like since (your family member) was injured? • What has been the most difficult for you since your family member was injured? • What has been the most helpful for you since your family member was injured? <p>Additional prompt questions were used.</p>	
Analysis	Thematic analysis, analysis of recurring topics. Themes emerging from the data were coded. Transcripts of interviews were read and re-read in entirety. A code book was developed to enable aspects of family members’ responses to be categorised. Verified by a second researcher.	
Themes with	Lots of themes emerged, but only one small section on information. The rest on getting the news, uncertainty, making sense of the news, moving	

Study	Keenan 2010 ²⁴²	
findings	on, progress of patient, transition and letting go/building a new connection, which were unrelated to discharge advice.	
	Information	<p>Time 1 (in acute care). The family expressed an intense “need to know” about their relative’s injuries and what the prognosis was. Most families wanted information that was consistent, understandable, honest and updated on a frequent basis. They wanted information specific to their relative, not based on statistics or probabilities. Most families felt well informed, but some were not reassured and felt they need more information.</p> <p>Time 2 (discharge from acute care, or in rehab or complex care settings, within one week of discharge). Need for information was important, but the intense “need to know” diminished. The number of exemplars related to information needs decreased by more than 50% from intensive care to acute care. Most families realised that there was no definite answers. “...you just always want to know, but there is no real answer. It is sort of unpredictable, so they told us what they could...give us the negatives and the positives – which we always didn’t want to hear the negatives, but they have to and that is the way it is. The positives come along. You feel you have another accomplishment and they are there to support you.”</p>
	Support	<p><u>Professional support</u> (time 2). The majority of descriptors referred to the positive support provided by the team as a whole, with nurses identified as providing support most often. Nurses were identified as spending time with the patient and family, developing a close link and being described as competent and having effective communication. Physician support was often linked to brief communication that was delivered in a supportive manner.</p> <p><u>Community support</u> (time 2). Continued community support was a vital factor assisting family members in coping. Emotional support from family and friends was described as a necessary part of the recovery, so that family didn’t feel alone in dealing with challenges. “Oh, the most helpful has been the support that we’re getting from his friends and our friends and families. It’s very important to have that support because you’re not in this alone, this continues to be a major part of our rehab, both my wife and mine, ‘cause it’s a long process and we need some support from friends and families and we’re getting it, and it’s helpful”.</p>
Limitations	<ul style="list-style-type: none"> • Family members were interviewed separately; different family needs may have been identified if the family were interviewed as a whole. • The large number of female caregivers may not reflect the reality of male caregivers. 	

H.6.2 Surveys

Table 54: Engel 2012

Study	Engel 2012 ¹²⁸	
Aim	To identify what patients understand following discharge from the ED - Identifies gaps in patients understanding post discharge. Measures concordance between direct patient recall and ED chart review.	
Population	Adult English-speaking patients, 24 - 36 hours after discharge from the ED with one of: ankle sprain, back pain (muscle strain), head injury, kidney stone or laceration. Exclusion criteria were non-English speaking patients, patients age <18 years, patients with significant psychiatric history, patients with a history of significant dementia or cognitive impairment, patients who were not responsible for their care at home, and any patient without a phone number listed in the chart. Survey took place between April 2010 - March 2011. N = 159 patients (29 patients with head injury). Country –USA	
Methods	2 types of computer generated discharge instruction sheets given to patients at discharge. 1st = patient specific (diagnosis, medications, follow up recommendations and open comments), 2nd = diagnosis specific (commercially available documents containing information on diagnosis, home care instructions and reasons to return to the emergency department). Telephone interviews were audiotaped and transcribed for review to assess satisfaction and understanding of discharge instructions. Interview contained scripted questions that were part of a structured interview guide.	
Analysis	Interviews transcribed in full and accuracy assessed. Domains were identified: diagnosis, medications, home care, follow up and return to ED. Patients were assessed at to level of understanding and key teaching points obtained from diagnosis specific discharge instructions. A four category concordance coding scale was used (no concordance, minimal concordance, partial concordance and complete concordance). <ol style="list-style-type: none"> 1. What were you told was wrong with you? 2. What medications, if any, were you told to take? 3. Were you told to do other things to take care of this problem besides taking medication? 4. Are you supposed to follow-up with any doctors about this problem? 5. Which symptoms or changes should cause you to come back to the ED? 	
Themes with findings	Percentage of severe knowledge deficits given by domain and diagnosis. (n = 29 head injured patients)	Diagnosis = 3.5%
		Medication = 3.6%
		Home care = 58.6%
		Follow up = 41.4%
		Return to ED = 44.4%

Study	Engel 2012¹²⁸
	Knowledge deficits most frequent for home care, follow-up and return to ED.
Limitations	Study looks at a range of patients diagnoses, one being head injury (other diagnoses have not been extracted into this evidence table) Did not assess literacy levels and the quality and quantity of verbal communication that was provided by the provider team.

Table 55: Falk 2009

Study	Falk 2009¹⁴⁰
Aim	To investigate how families with children perceive information provided after a head injury.
Population	<p>Families of children (0-15 years) who visited the emergency department with a history of head injury , and with the initial tentative diagnosis of concussion made by a triage nurse.</p> <p>51 families with children aged < 5 and 45 families with children aged 5 and over. N = 96 children and parents</p> <p>Groups identified:</p> <ul style="list-style-type: none"> • Minimal head injury (no unconsciousness, GCS 15) - 79%, n = 76 • Mild head injury (unconsciousness <5 mins and/or amnesia, GCS 14 - 15) 15%, n = 14 • Moderate head injury (GCS 9 - 13) 1%, n = 1 • Severe head injury (GCS <8) <p>5 (5%) children unclassifiable due to lack of information in medical records.</p> <p>93% from falls, 1% sport related, 1% traffic related, 1% bumps on head.</p> <p>Exclusion criteria were a severe head injury, other injuries than the head injury or a head injury caused by violence or abuse.</p> <p>Country - Sweden</p>
Methods	<p>Questionnaire given to families to investigate general opinion of information given - posted 3 months after head injury. Families were directed to let the child answer, or the parent or together. For children < 5 parents completed the questionnaire. The content was then discussed with a multi-professional team for validation.</p> <ul style="list-style-type: none"> • Did you understand the information you received concerning the head injury? (in most, in some, not at all) • Did you receive you receive the information you needed regarding head injury? (in most, in some, not at all) • Did you receive information about common symptoms? (Yes, no, don't know) • Was the information you received age appropriate for your child? (Yes, no, don't know) • Was the information about the head injury addressed to your child specifically? (Yes, no, don't know) • Who informed you during your stay at the ED? (attending physician, nurse, both or other) • Have you been in contact with any healthcare service because of the head injury after your visit at the ED? (Yes/No)

Study	Falk 2009 ¹⁴⁰
	<ul style="list-style-type: none"> Any other comments?
Analysis	Children divided into 2 age groups (<5 and 5 and over. Descriptive statistical procedures were computed and chi square used to compare categorical variables and the severity of head injury with the information questions.
Themes with findings	<p>Informational needs -</p> <ul style="list-style-type: none"> 83% of families stated they for the most part understood information concerning the injury. 69% for the most part did get the information they needed about the head injury before discharge. Age 5 and over 46% received information about common symptoms, compared to 20% of <5 year olds. Age 5 and over 58% received age appropriate information compared to 16% in younger age group. 59% received info from both physician and nurse, 28% physician only and 13% from nurse only 17% contacted healthcare services because of questions about the head injury after their visit to the ED - no difference between age groups.
Limitations	None identified

Table 56: Heng 2007

Study	Heng 2007 ¹⁹⁸
Aim	To evaluate patients' and caregivers' compliance to discharge instructions and their ability to recall HI advice.
Population	<p>Adults diagnosed with minor head injury discharged from ED within 24h of presentation.</p> <p>N = 110 adults between April 2006 - May 2006 Questionnaire drafted based on the head injury advice leaflet given to patients. Questionnaire asked about patient's well-being and general symptoms and if they received head injury advice upon discharge from the ED. Surveys were terminated if they did not receive any advice. The second part of the questionnaire assessed compliance to 3 instructions in the leaflet: whether the patient had been left alone for more than 2 hours, whether they drank alcohol or drove any vehicle within 24h of discharge. The third part assessed the patient's ability to recall the 9 symptoms in the leaflet.</p> <p>Country = Singapore</p>
Methods	Questionnaire drafted based on the head injury advice leaflet given to patients. Questionnaire asked about patient's well-being and general symptoms and if they received head injury advice upon discharge from the ED. Surveys were terminated if they did not receive any advice. The second part of the questionnaire assessed compliance to 3 instructions in the leaflet: whether the patient had been left alone for more than 2 hours, whether they drank alcohol or drove any vehicle within 24h of discharge. The third part assessed the patient's ability to recall the 9 symptoms in the leaflet.

Study	Heng 2007¹⁹⁸
Analysis	Data analysed using SPSS. Categorical data was analysed with chi-square test, and scale data analysed with Student's t-test.
Themes with findings	Interviewees responded that head injury advice was given to patient, caregiver, both patient and caregiver 57%, 26% and 16% of the time respectively. 29% reported non-compliance to head injury advice, 19% were left alone for more than 2 hours, 7% drove a vehicle and 3% drank alcohol within 24 hours of injury. Maximum number of symptoms recalled was 6 (mean 1.9 SD 1.3). Commonest symptoms recalled were persistent vomiting (64%), dizziness (53%) and persistent headache (35%). Least recalled were seizures (4%). Incorrect symptoms recalled included fever, numbness, feeling cold, tinnitus, sore throat and cold sweats. Recall scores not statistically different regardless of how advice given (verbally or printed, or both). Scores statistically higher in females compared to males and no difference in age, race or nationality.
Limitations	None identified

Table 57: McMillan 2009

Study	McMillan 2009²⁹⁷
Aim	To explore views of hospital attenders about advice received and compliance with advice
Population	Participants recruited during attendance at the ED for head injury and followed up by telephone within 1 month. Patients over 15. Patients with abnormal neurological signs, loss of consciousness, post traumatic amnesia for more than 5 mins, abnormal behaviour, significant medical or social problems or skull fracture are normally admitted. Inpatients were excluded as were those who were self discharged. 200 patients assessed (194 followed up by telephone, 6 postal questionnaire only) within 4-31 days of injury during a 6 month period in 2006 Country - Scotland
Methods	Back ground information taken from medical records. Telephone interview - post-concussional symptom checklist. Questions about information and compliance with advice involved open ended questions: Were you given advice? What advice were you given? What did you think of the advice? Is your daily routine the same as it was before the injury? If not how has it changed? Prompts were used about 5 categories given in the information sheet and SIGN recommendation.
Analysis	Information was quantified in terms of presence or absence of knowledge or action. Categorical variables were described using the number and percentage of participants and were compared between groups using chi squared test.
Themes with findings	Details on views about advice and memory for compliance to advice. Other information about retrospective assessment of post traumatic amnesia and symptom reporting not linked to discharge advice.

Study	McMillan 2009 ²⁹⁷	
	Views about advice	<p>82.5% of attenders (and 5.5% relatives) received a leaflet, 6.5% did not and 5.5% could not remember.</p> <p>92% of those who received advice had read it.</p> <p>8% had been given advice in the emergency department, but had not received a leaflet.</p> <p>Overall 96% said that advisory information had been given in some form.</p> <p>Satisfaction with overall advice was positive for 84.5%, negative for 4.5% and the remainder said they could not remember the advice.</p>
	Memory for and compliance with advice	<p>Memory for advice was poor (remembered advice correctly) – work (36%), sport (36%), medication (38%), alcohol (44%), rest/sleep (56%).</p> <p>Of those who acknowledged receiving advice about specific categories, few said they did not follow it – work (4%), sport (1%), medication (0%), alcohol/drugs (4%), rest/sleep (6%), although this was not verifiable.</p> <p>Those who would have been admitted under SIGN 46 criterion of post traumatic amnesia >5 minutes, more often did not know whether or not they had received advice ($p < 0.0001$) or the leaflet ($p = 0.023$).</p> <p>Forward stepwise multiple logistic regression on demographics and hospital record variables, values of adjusted R^2 were low (<15% for all models) and no informative regression model emerged: the odds ratio confidence interval was wide for each covariate – no factors associated with memory for advice.</p>
Limitations	Study author notes that there may be bias from self reported data and that the future studies may also include separate interviews with a friend or relative who was in close contact with the participant before and after the injury.	

Table 58: Yates 2006

Study	Yates 2006 ⁵³⁹
Aim	To investigate health literacy in emergency department patients and to assess differences in understanding standard and simplified head injury advice sheets.
Population	<p>Emergency medicine patients aged 15 years or over. Patients were excluded if they were unable to comprehend spoken or written English, if they had severe illness or pain, if they were triaged as needing to be seen immediately, if they had a significant eye condition or complaint, or if their corrected visual acuity was less than font size 10.</p> <p>N = 200</p> <p>Country – New Zealand</p>
Methods	A prospective randomised trial using a convenience sample of adults - randomised using opaque envelopes given either Accident Compensation Corporation (ACC) head injury advice sheet or the simplified sheet. Participants were given 5 - 10 mins to read the advice sheet and then were interviewed by a researcher, using a data collection sheet that included a script to standardise the interviews. Participants were asked 10

Study	Yates 2006 ⁵³⁹	
	questions to assess comprehension of the advice sheet and were able to refer to their sheet at any time. Data was also collected on gender, age, years of schooling and ethnicity and also shown the advice sheet they had not seen and asked which they preferred.	
Analysis	Health literacy was estimated using the Rapid Estimate of Adult Literacy in Medicine (REALM), a validated word recognition test that takes 3 - 5 mins to administer and classifies participants in to 3rd grade or less, 4-6th grade, 7 - 8th grade, high school (9th grade) or above. Logistic regression used to investigate interaction of literacy levels and the form used.	
Themes with findings		<p>Logistic regression showed no evidence of effect of the form on comprehension scores for different REALM groups.</p> <p>Simplified form preferred by both study groups: 94% of those in ACC and 95% in simplified group.</p> <p>Comprehension scores (questions correct out of 10) for the group were – median of 9 for ACC and 10 for simplified. Mann-Whiney U test showed that the simplified for group had significantly higher comprehension scores (p<0.0001).</p> <p>Recommendations: People of all literacy levels prefer (and have a better understanding of) simple written materials compared to complex material. Simplified advice sheet was at 5th grade level or lower, that common words should be used or difficult words explained, that short sentences and large font be used, and that the layout should have large blank spaces to make text look easier to read. They also aimed to provide a simple one-page document that was "internet friendly" so that the document could be stored on the ED intranet website and printed off anywhere in the department when busy.</p>
Limitations	<p>Emergency medicine patients rather than specific to head injury population?</p> <p>High level of literacy in population - low representation from lower literacy groups and therefore may be less applicable to other emergency departments.</p> <p>Over 20% of patients approached declined to participate for various reasons – selection bias likely.</p>	

Table 59: Stevens 2010

Study	Stevens 2010 ⁴⁹⁰	
Aim	To evaluate parents ability to identify postconcussive symptoms in children when given verbal and written discharge instructions.	
Population	<p>Parents of consecutive children with mild TBI aged 5 - 17 who were treated and released from the paediatric emergency department after having been seen for concussion. Children under 5 were excluded, as verbal report of postconcussive signs would likely be inconsistent in this age group. Inclusion criteria - traumatic mechanism of injury, no evidence of intracranial haemorrhage in CT scan, GCS 15 on discharge, ability to speak and understand English. Exclusion criteria – inpatient hospital admission, GCS 14 or less upon discharge from the emergency department, positive finding on CT scan, inability to speak or understand English, and patients without a telephone.</p> <p>105 parents of children aged 5 - 17 years in Autumn 2009</p> <p>Country - USA</p>	

Study	Stevens 2010 ⁴⁹⁰
Methods	Questionnaire by telephone call 2 - 5 days post injury (to coincide with peak of postconcussive symptoms) for data collection from parents - based on CDC categories for screening paediatric athletes for postconcussive symptoms: headache or pressure to the head, nausea, balance problems or dizziness, double or fuzzy vision, sensitivity to light or noise, feeling sluggish or slowed down, feeling foggy or groggy and does not "feel right". There are also 5 additional signs that a parent may identify used in the questionnaire: appears dazed or stunned, moves clumsily, answers questions slowly, loses consciousness, even briefly and shows behaviour or personality changes. Additional data included demographic information, mechanism of injury, and test results.
Analysis	Results of each parameter were analysed in aggregate to determine frequency of each sign or symptom, and to identify any relationships between gender, age, type of injury, and symptomology.
Themes with findings	<p>Of 105 children with TBI, 62.9% developed postconcussive symptoms</p> <p>69.5% of parents initially stated their child did not exhibit post concussive signs or symptoms.</p> <p>When asked about each sign or symptom individually, 46.6% of parents who reported an asymptomatic child identified 1 or more symptoms in their child.</p> <p>In symptomatic children, there was a significant difference between those parents who were able to identify symptoms in their child and those who could not (χ^2 (1, N = 66) = 16.01, p <0.05), supporting the hypothesis that parents of postconcussive children were unable to recognise symptoms in their children.</p> <p>Of parents who reported that their children was asymptomatic, when asked about the symptoms individually, headache was the most common observed symptom (37%), followed by nausea (12.7%), feeling slow r sluggish (11%), appearing dazed or stunned (4.1%), answering questions slowly (4.1%), dizziness or balance problems (2.7%), and behaviour or personality changes (2.7%).</p> <p>The remainder of parents reported that their children was symptomatic (30.5%). Headache was the most common observed symptom (81.3%), followed by nausea (28.1%), feeling slow r sluggish (28.1%), not feeling right (21.9%) and balance problems or dizziness (18.8%).</p> <p>No significant relationship between symptomatic and asymptomatic children with respect to age, gender or mechanism of injury.</p> <p>Study concludes that current methods of providing discharge instructions to parents of children with concussion are ineffective and suggests individualised care planning should be done by the nurse to meet the needs of the family.</p>
Limitations	None identified

Appendix I: Economic evidence tables

I.1 Clinical decision rules for imaging the head

Table 60: Pandor 2011³⁷⁹

A. Pandor, S. Goodacre, S. Harnan, M. Holmes, A. Pickering, P. Fitzgerald, A. Rees, and M. Stevenson. Diagnostic management strategies for adults and children with minor head injury: a systematic review and an economic evaluation. Health Technol.Assess. 15 (27):1-202, 2011.				
Study details	Population & interventions	Costs	Health outcomes	Cost-effectiveness
<p>Economic analysis: CUA (health outcome = QALYs)</p> <p>Study design: Probabilistic decision analytical model</p> <p>Approach to analysis: Markov model estimating the cost-effectiveness of diagnostic strategies for mild head injury (MHI) for children and adults. Patients assumed to: i) have an intracranial lesion requiring neurosurgery (e.g. extradural haemorrhage); or ii) intracranial lesion not requiring surgery; or iii) no intracranial</p>	<p>Population: Adults and children admitted to ED with mild head injury (MHI).</p> <p>Cohort settings: Start age = decision rules evaluated for 1, 10, 40 and 75 years old</p> <p>Decision rules for adults: CT all (theoretical); “abnormal arrival” GCS; CCHR (high risk); CCHR (high or medium risk); NCWFNS; NOC; NEXUS II; NICE; Scandinavian.</p> <p>Decision rules for children: CT all (theoretical option); CHALICE, PECAR, UCD and therule of Atabaki et al 2008.</p>	<p>Total costs (mean per patient) for adults aged 40 years (with and without intracranial lesion): Discharge all: £3305 Abnormal arrival GCS: £2991. CT all: £2955. NCWFNS: £2911. Scandinavian: £2905. NEXUS II: £2908. NICE: £2923. CCHR (high risk): £2918. NOC: £2922. CCHR (high or medium risk): £2909.</p> <p>Total costs (mean per patient) for adults aged 75 years (with and without intracranial lesion): Discharge all: £1716 Abnormal arrival GCS: £1543</p>	<p>QALYs (mean per patient) for adults aged 40 years (with and without intracranial lesion): Discharge all: 18.6633 Abnormal arrival GCS: 18.6839 CT all: 18.6868 NCWFNS: 18.6878 Scandinavian: 18.6880 NEXUS II: 18.6880 NICE: 18.6881 CCHR (high risk): 18.6882 NOC: 18.6884 CCHR (high or medium risk): 18.6888</p> <p>QALYs (mean per patient) for adults aged 75 years (with and without intracranial lesion): Discharge all: 7.8277 Abnormal arrival GCS: 7.8363 CT all: 7.8368</p>	<p>ICER compared with next last effective treatment on the NICE frontier – adults aged 40 years (with and without intracranial lesion): The following strategies were dominated: Discharge all; Abnormal arrival GCS; CT all; NCWFNS; NICE, CCHR (high risk); NOC. The NEXUS II strategy was extendedly dominated. CCHR (high or medium risk) versus Scandinavian: £3879 per QALY gained (pa) CI: Not reported Probability CCHR (high or medium risk) cost-effective for willingness –to-pay thresholds between £0 and £50,000 is 28-42%</p> <p>ICER compared with next last effective treatment on the NICE frontier – adults aged 75 years (with and without intracranial lesion): The following strategies were dominated:</p>

<p>haemorrhage on admission to ED. Health states were modelled as Glasgow Outcome Scores (GOS) states over time.</p> <p>Perspective: UK NHS Time horizon: lifetime</p> <p>Treatment effect duration: GOSs at 1 year were compared with outcomes at 5-7 years, with patients randomly assigned a time between 5 and 7 years at which point they change state, based on Whitnall et al. After that, patients were assumed to stay in that state for life as no further data were available.</p> <p>Discounting: Costs and outcomes discounted at a rate of 3.5%</p>		<p>CT all: £1567 NCWFNS: £1523 NICE: £1535 NEXUS II: £1520 Scandinavian: £1517 NOC: £1534 CCHR (high risk): £1521 CCHR (high or medium risk): £1521</p> <p>Total costs (mean per patient) for a child aged 10 years (with and without intracranial lesion): CHALICE: £3567 PECARN: £3611 UCD: £3608 Atabaki et al: £3621 CT all: £3666 Discharge all: £4115</p> <p>Total costs (mean per patient) for a child aged 1 year (with and without intracranial lesion): CHALICE: £3648 PECARN: £3699 UCD: £3700 Atabaki et al: £3713 CT all: £3771 Discharge all: £4206</p>	<p>NCWFNS:7.8376 NICE: 7.8376 NEXUS II: 7.8377 Scandinavian: 7.8377 NOC: 7.8378 CCHR (high risk): 7.8378 CCHR (high or medium risk): 7.8381</p> <p>QALYs (mean per patient) for children aged 10 years (with and without intracranial lesion): CHALICE: 22.4156 PECARN: 22.4119 UCD: 22.4112 Atabaki et al: 22.4108 CT all: 22.4072 Discharge all: 22.3847</p> <p>QALYs (mean per patient) for children aged 1 year (with and without intracranial lesion): CHALICE: 22.9857 PECARN: 22.9787 UCD: 22.9760 Atabaki et al: 22.9764 CT all: 22.9663 Discharge all: 22.9549</p>	<p>Discharge all; Abnormal arrival GCS; CT all; NCWFNS; NICE; NEXUS II; NOC; CCHR (high risk).</p> <p>CCHR (high or medium risk) versus Scandinavian: £10,397 per QALY gained (pa) CI: Not reported</p> <p>Probability CCHR (high or medium risk) cost-effective for willingness –to-pay thresholds between £0 and £50,000 is 34-42%</p> <p>ICER for children aged 10 years (with and without intracranial lesion): CHALICE dominant strategy CI: Not reported</p> <p>Probability CHALICE cost-effective for willingness –to-pay thresholds between £0 and £50,000 is 70-100%</p> <p>ICER for children aged 1 year (with and without intracranial lesion): CHALICE dominant strategy CI: Not reported</p> <p>Probability CHALICE cost-effective for willingness –to-pay thresholds between £0 and £50,000 is 75-100%</p> <p>Analysis of uncertainty: (describe</p>
---	--	---	---	---

		<p>Currency & cost year: 2008 UK pounds</p> <p>Cost components incorporated: ED visit; CT scan; admission with no deterioration or neurosurgery; neurosurgical intervention before deterioration; long-term costs for patients with GOS 3 and 4; intensive care, rehabilitation, and nursing home costs for patients with GOS 2; costs of cancer (due to radiation exposure)</p>		<p>methods and give a verbal overview of the results, describing factors that were sensitive and reporting important thresholds at which the most c/e strategy shifts)</p> <p>Several sensitivity analyses were conducted.</p> <p>First, the deterministic findings for all patients groups were replicated using the prevalence estimates of neurosurgical and non-neurosurgical lesions in Stein et al. The CHALICE rule remained dominant for children, but the NEXUS II rule was dominant for adults (but the absolute cost and QALY differences between the CCHR and NEXUS II were very small in both analyses and attributable to small differences in point estimate of sensitivity).</p> <p>Univariate SA was conducted on several parameters using lowest and highest value of 95% CI – for all ages, no parameter change altered the decision on optimal strategy. The findings were also not sensitive to changes in the interest rate (from 0 to 6%).</p> <p>PSA showed that the optimal strategy for children (aged 1 and aged 10 years) remains the CHALICE rule. For adults, the CCHR (high or medium risk) was found to dominate all other strategies, both for 40</p>
--	--	--	--	--

and 75 years old.

Data sources

Health outcomes:

To estimate outcomes, a systematic review and fixed-effect meta-analysis was conducted to estimate the proportion of patients in GOS states (from 1 to 5) post intervention (i.e. neurosurgery). Movements between GOS states over time based were estimated from a prospective cohort study by Whitnall et al. (2006). This determined the outcomes at 5-7 years compared with outcomes at 1 year. Types, relative prevalence and costs of radiation-induced cancers in children based on estimated in Stein et al. (2008).

Quality-of-life weights: EQ5D from Smits et al. (2007) and Smits et al. (2010)

Cost sources: National Schedule of Reference Costs 2007-08; PSSRU 2009; Beecham et al (2009) for long term costs for GOS 4 and 3.

Comments

Source of funding: National Institute for Health Research - Health Technology Assessment programme

Limitations:

The model presents the following limitations:

- 1) Estimating the benefit of treating neurosurgical and non-neurosurgical lesions relied upon observational data with small numbers. For example, the probabilities of GOS 2 and 3 are subject to great uncertainty, which in turn can greatly affect the cost-effectiveness findings. However the study estimates were validated by experienced neurosurgeons and emergency physicians who felt that the estimates were appropriate.
- 2) The model assumed that hospital admission and treatment provided no benefit for patients with a non-neurosurgical lesion that did not deteriorate or those with a normal CT scan, as no clear evidence was found of these benefits.
- 3) Limitations of the primary data used in the model were especially important for the children analyses, as very little validation of clinical decision rules has been conducted in this area. It was found that the diagnostic parameters (particularly specificity) varied between the derivation data and the limited validation data available. This implies greater uncertainty over the conclusions for optimal decision rules for children respect to adults.
- 4) No data was available to investigate patients with MHI who are on anticoagulant medication
- 5) The model favour policies that provide treatment more promptly, as a consequence of the assumption that patients in GOS states keep their associated level of utility over the entire time horizon.

Other: 95% confidence interval and p-values not reported for cost and QALY outcomes

Overall applicability*: Directly applicable **Overall quality**:** Potentially serious limitations

Abbreviations: CCA = cost-consequence analysis; CEA = cost-effectiveness analysis; CI = 95% confidence interval; CUA = cost-utility analysis; ED = Emergency Department; EQ-5D = Euroqol five dimensions (scale: 0.0 [death] to 1.0 [full health]; <0.0 = worse than death); GOS = Glasgow Outcome Scores ; ICER = incremental cost-effectiveness ratio; NR = not reported; MHI = mild head injury; pa = probabilistic analysis; PSA = Probabilistic Sensitivity Analysis; QALYs = quality-adjusted life years; SA = sensitivity analysis

** Directly applicable / Partially applicable / Not applicable; ** Minor limitations /Potentially serious limitations / Very serious limitations
Partially applicable / Not applicable; ** Minor limitations /Potentially serious limitations / Very serious limitations*

Appendix J: Forest plots

J.1 Clinical decision rules for imaging the head (reproduced from HTA and updated)

J.1.1 Decision rules for adults with mild head injury: sensitivity and specificity for which more than one data set is available for the outcome intracranial injury.

Figure 3: CCHR high and medium risk: intracranial injury

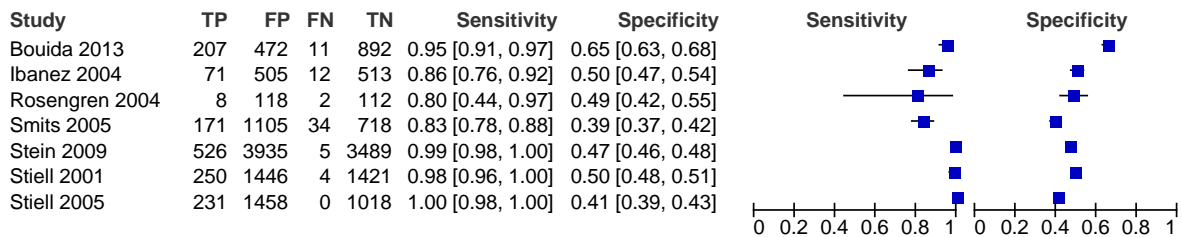

Figure 4: CCHR high and medium risk adapted to cohort: intracranial injury

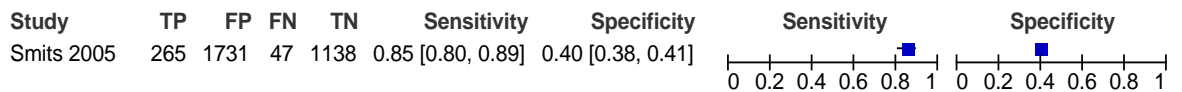

Figure 5: NOC: intracranial injury

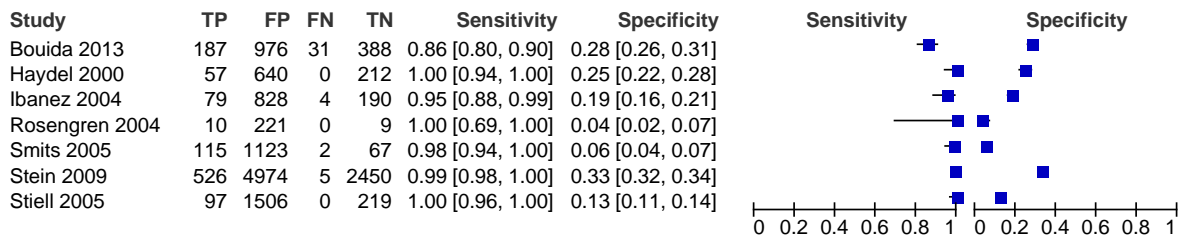

Figure 6: NOC adapted to cohort: intracranial injury

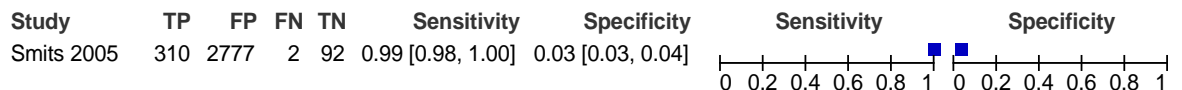

Figure 7: NCWFNS high and medium risk: intracranial injury

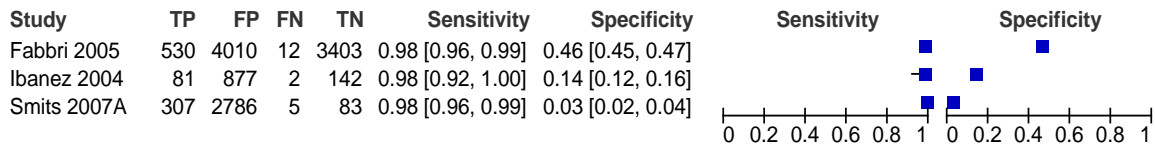

Figure 8: NICE lenient: intracranial injury

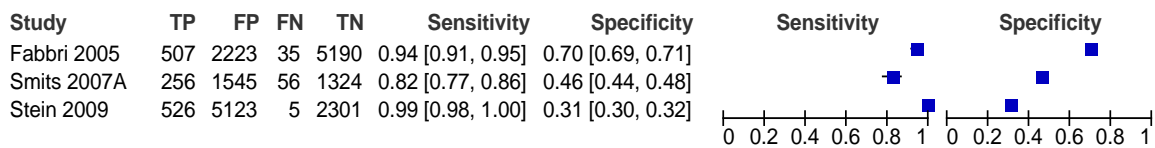

Figure 9: Scandinavian lenient criteria: intracranial injury

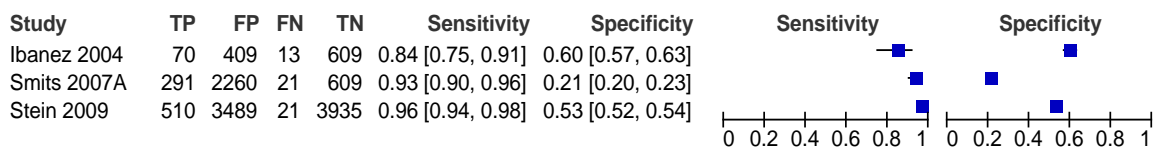

Figure 10: CCHR high risk: intracranial injury

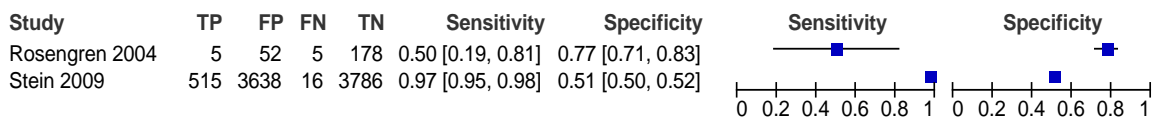

Figure 11: Arienta et al. 1997 rule: intracranial injury

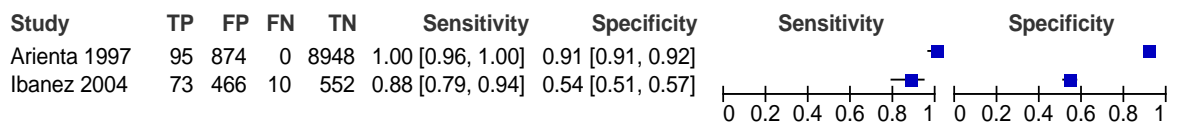

Figure 12: Madden et al. 1995 rule: intracranial injury

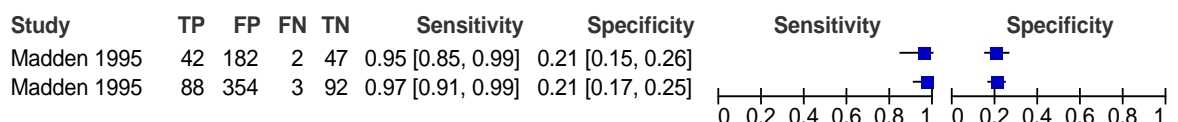

Figure 13: Ono et al. 2007 rule: intracranial injury

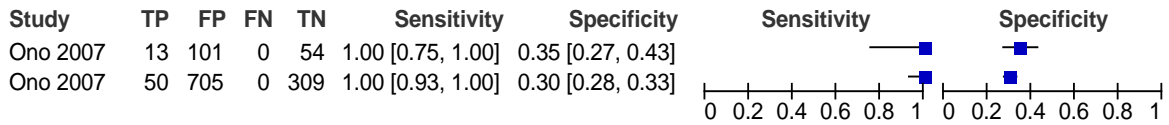

Figure 14: SIGN 2000 CT urgently: intracranial injury

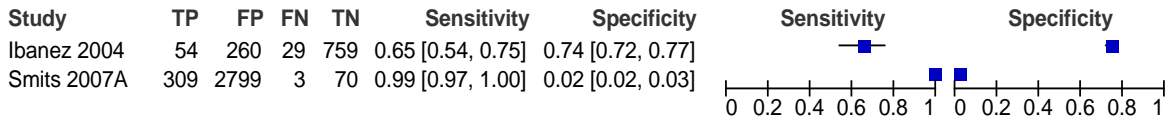

Figure 15: NEXUS II: intracranial injury (update with Ro 2011)

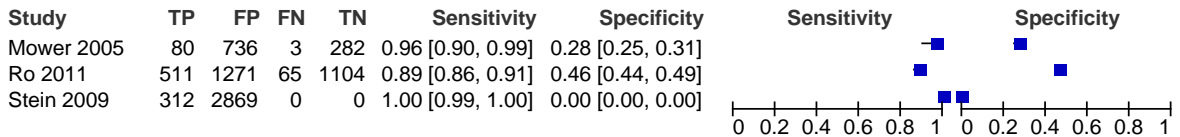

Figure 16: EFNS CT recommended and mandatory: intracranial injury

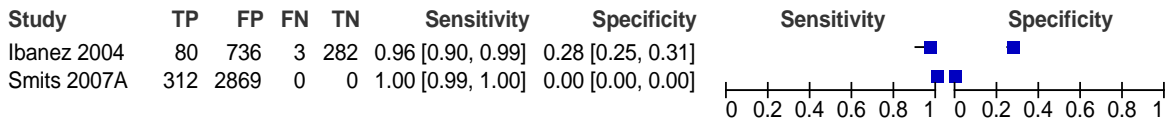
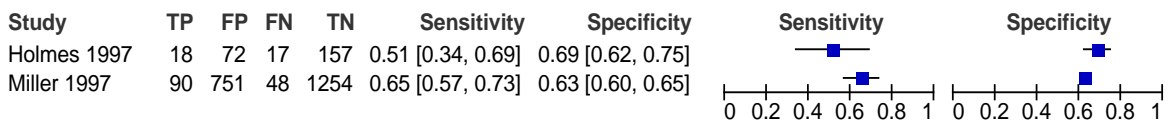

Figure 17: Miller et al. criteria: intracranial injury



J.1.2 Decision rules for adults with mild head injury: sensitivity and specificity for which more than one data set is available for the outcome need for neurosurgery.

Figure 18: CCHR high risk: neurosurgery

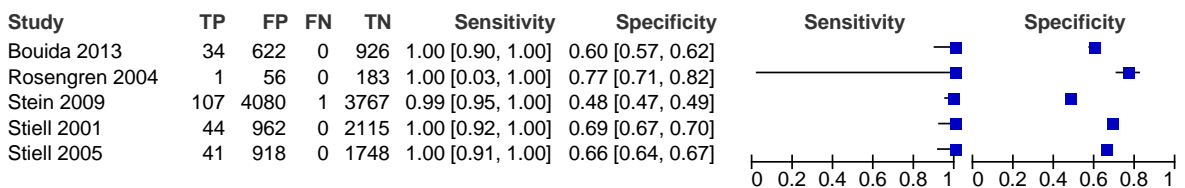

Figure 19: NOC: neurosurgery

Study	TP	FP	FN	TN	Sensitivity	Specificity
Boudia 2013	28	1152	6	396	0.82 [0.65, 0.93]	0.26 [0.23, 0.28]
Rosengren 2004	1	230	0	9	1.00 [0.03, 1.00]	0.04 [0.02, 0.07]
Smits 2005	2	1236	0	69	1.00 [0.16, 1.00]	0.05 [0.04, 0.07]
Stein 2009	107	5414	1	2433	0.99 [0.95, 1.00]	0.31 [0.30, 0.32]
Stiell 2005	8	1595	0	219	1.00 [0.63, 1.00]	0.12 [0.11, 0.14]

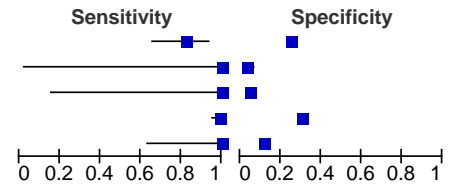

Figure 20: NOC adapted to cohort: neurosurgery

Study	TP	FP	FN	TN	Sensitivity	Specificity
Smits 2005	17	3070	0	94	1.00 [0.80, 1.00]	0.03 [0.02, 0.04]

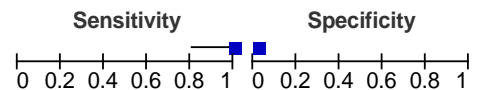

Figure 21: CCHR high and medium risk: neurosurgery

Study	TP	FP	FN	TN	Sensitivity	Specificity
Rosengren 2004	1	125	0	114	1.00 [0.03, 1.00]	0.48 [0.41, 0.54]
Smits 2005	7	1269	0	752	1.00 [0.59, 1.00]	0.37 [0.35, 0.39]
Stein 2009	107	4316	1	3531	0.99 [0.95, 1.00]	0.45 [0.44, 0.46]

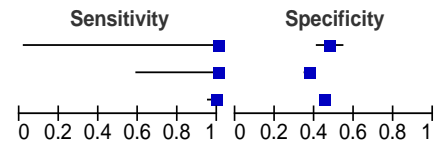

Figure 22: CCHR high and medium risk adapted to cohort: neurosurgery

Study	TP	FP	FN	TN	Sensitivity	Specificity
Smits 2005	17	1979	0	1185	1.00 [0.80, 1.00]	0.37 [0.36, 0.39]

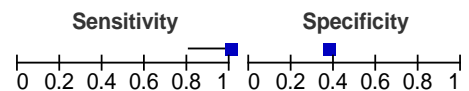

Figure 23: NCWFNS high and medium risk: neurosurgery

Study	TP	FP	FN	TN	Sensitivity	Specificity
Fabbri 2005	107	4433	1	3414	0.99 [0.95, 1.00]	0.44 [0.42, 0.45]
Smits 2007B	16	3077	1	87	0.94 [0.71, 1.00]	0.03 [0.02, 0.03]

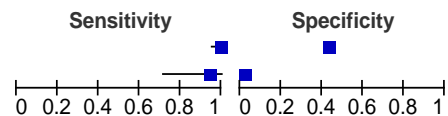

Figure 24: NICE lenient criteria: neurosurgery

Study	TP	FP	FN	TN	Sensitivity	Specificity
Fabbri 2005	102	2628	6	5219	0.94 [0.88, 0.98]	0.67 [0.65, 0.68]
Smits 2007B	16	1785	1	1379	0.94 [0.71, 1.00]	0.44 [0.42, 0.45]
Stein 2009	106	5571	2	2276	0.98 [0.93, 1.00]	0.29 [0.28, 0.30]

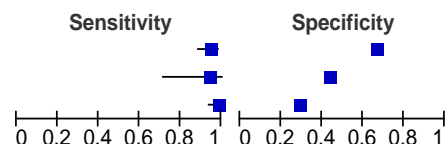

Figure 25: Scandinavian lenient criteria: neurosurgery

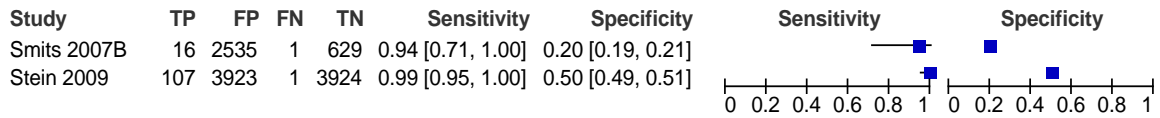
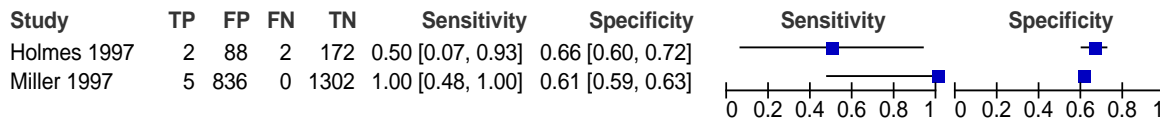

Figure 26: Miller et al. criteria: neurosurgery



J.1.3 Decision rules for children with mild head injury: sensitivity and specificity for which more than one data set is available for the outcome intracranial injury.

Figure 27: Pilot PECARN rule: intracranial injury

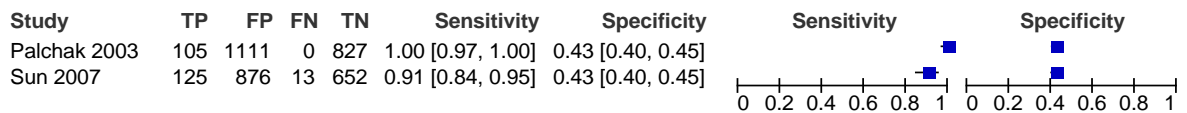

Figure 28: PECARN rule: intracranial injury

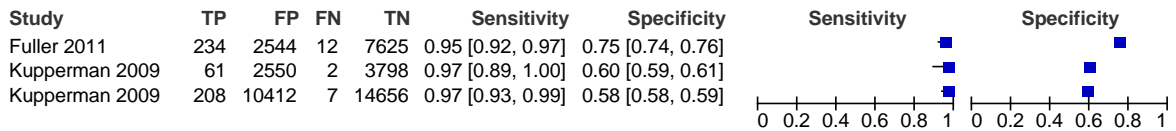
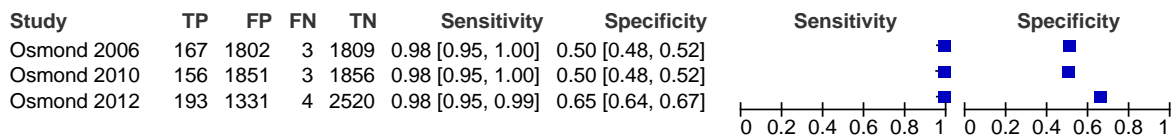

Figure 29: CATCH rule: intracranial injury (update)



J.1.4 Decision rules for children with mild head injury: sensitivity and specificity for which only one data set is available for the outcome intracranial injury.

Figure 30: Atabaki et al, 2008: intracranial injury

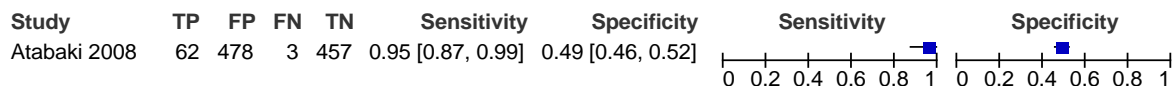

Figure 31: CHALICE rule: intracranial injury

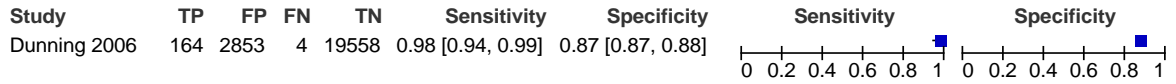

Figure 32: Da Dalt et al. group A+B vs C+D: intracranial injury

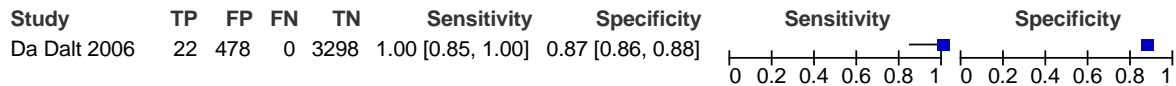

Figure 33: Dietrich et al. 1993 rule: intracranial injury

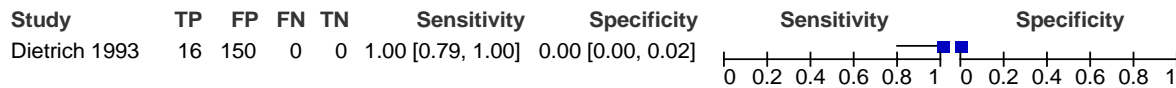

Figure 34: Guzel et al. 2009 rule: intracranial injury

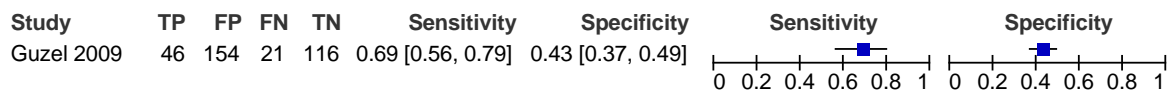

Figure 35: NEXUS II: intracranial injury

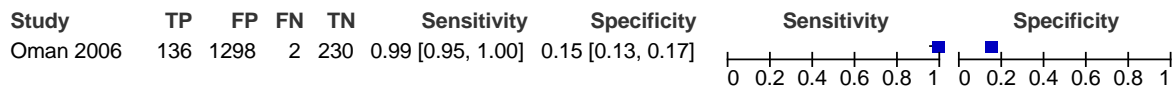

Figure 36: NOC: intracranial injury

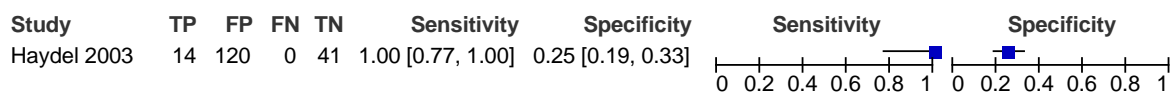

Figure 37: Quayle 1997 rule: intracranial injury

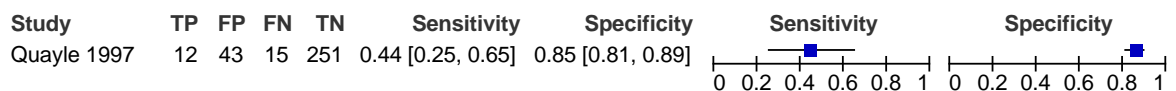
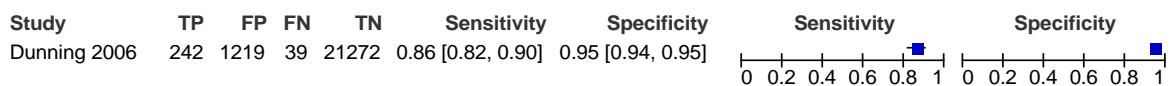

Figure 38: RCS guidelines: intracranial injury



J.1.5 Decision rules for children with mild head injury: sensitivity and specificity for the outcome neurosurgery.

Figure 39: Atabaki et al, 2008: neurosurgery

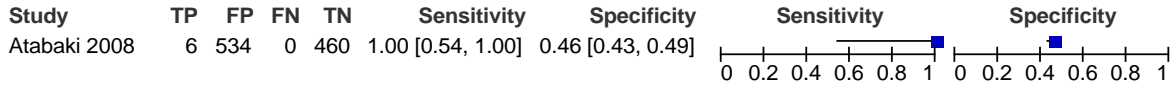

Figure 40: CATCH rule: neurosurgery (update)

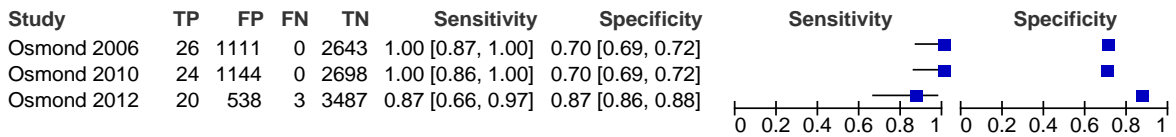

Figure 41: CHALICE rule: neurosurgery

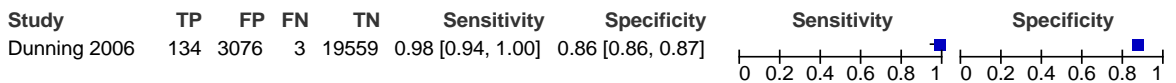

Figure 42: NOC: neurosurgery

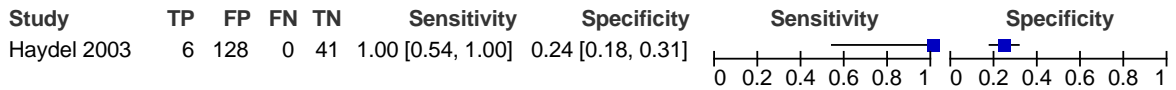

Figure 43: Pilot PECARN rule: neurosurgery

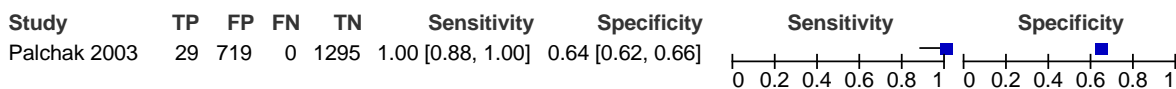
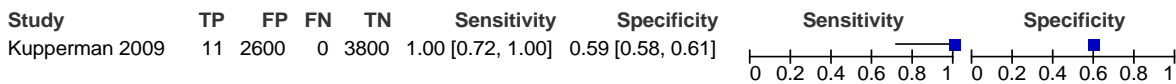

Figure 44: PECARN > 2 years: neurosurgery



J.1.6 Decision rules for infants with mild head injury: sensitivity and specificity for the outcome intracranial injury.

Figure 45: PECARN < 2 years rule: intracranial injury infants

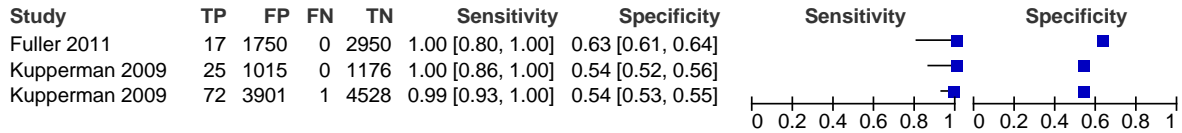

Figure 46: Pilot PECARN rule: traumatic brain injury only, infants

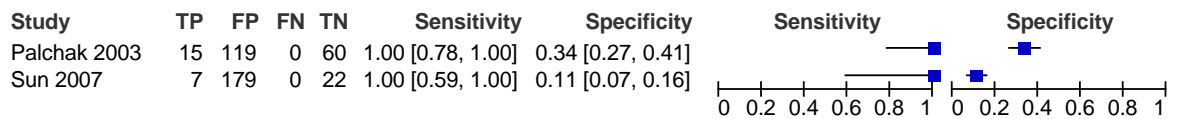

Figure 47: Buchanich et al. 2007 rule: intracranial injury infants

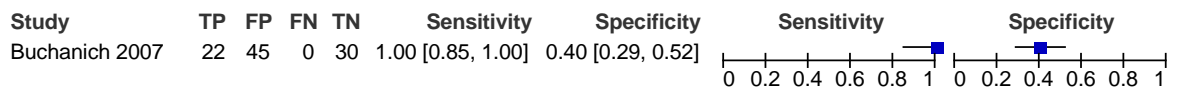

Figure 48: Dietrich et al. 1993 rule: intracranial injury infants

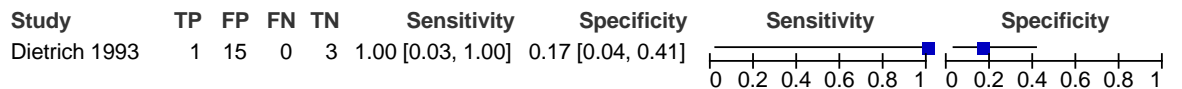

Figure 49: Greenes and Schutzman 1999 rule: intracranial injury infants

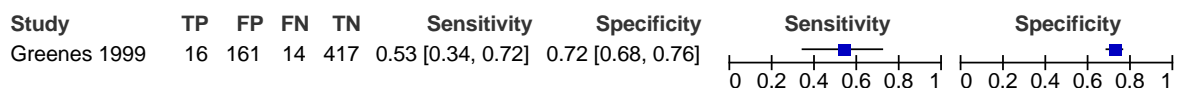

Figure 50: Greenes and Schutzman 2001 scoring system: intracranial injury infants

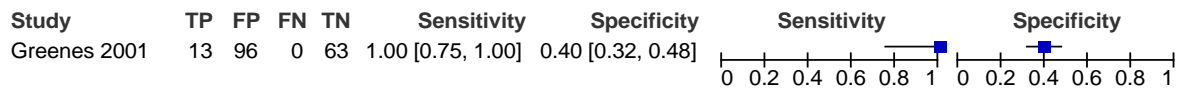

Figure 51: NEXUS II: intracranial injury infants

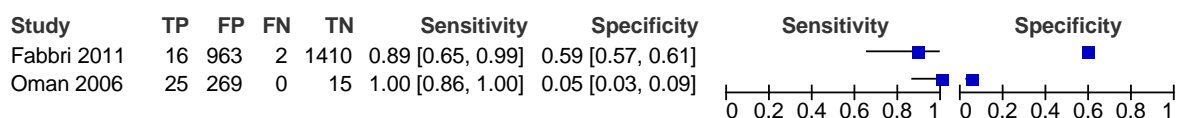
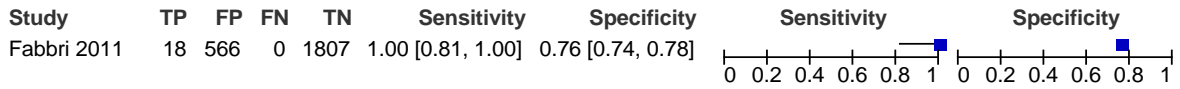
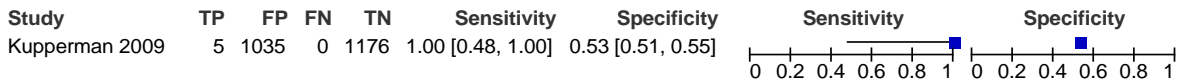

Figure 52: Fabbri et al., 2011: intracranial injury infants



J.1.7 Decision rules for infants with mild head injury: sensitivity and specificity for the outcome neurosurgery.

Figure 53: PECARN < 2 years rule: intracranial injury infants



J.2 Biomarkers

J.2.1 S100B

Figure 54: S100B - intracranial injury in adults

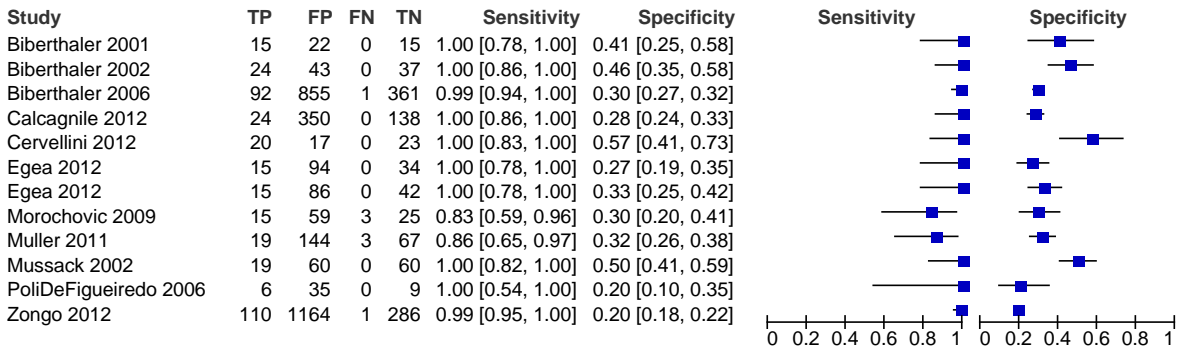
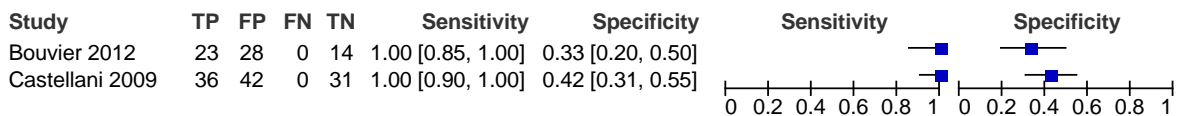

Figure 55: S100B - intracranial injury in children



J.2.2 NSE

Figure 56: NSE - intracranial injury in adults

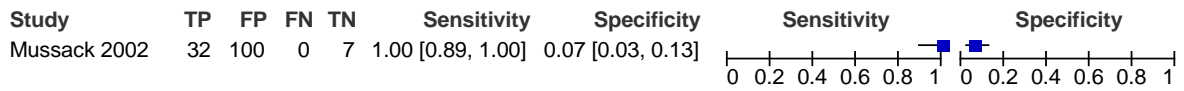
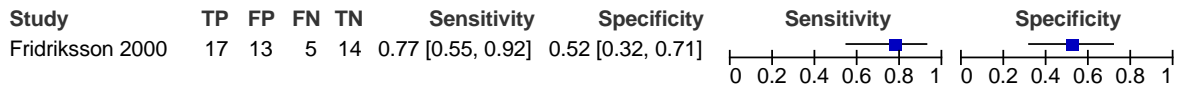

Figure 57: NSE - intracranial injury in children



J.2.3 GFAP

Figure 58: GFAP - intracranial injury in adults

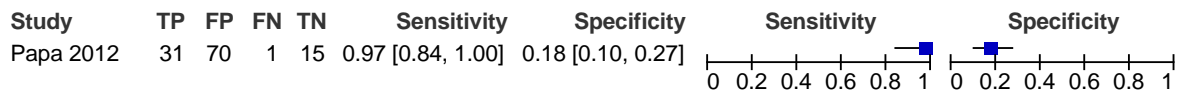
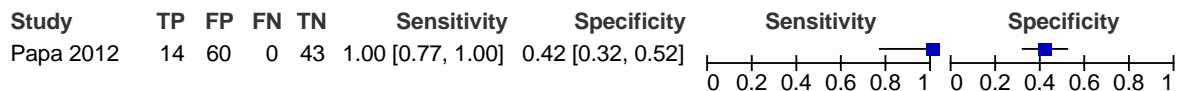

Figure 59: GFAP – Need for neurosurgery in adults



J.3 Clinical decision rules for cervical spine imaging

J.3.1 Adults – initial imaging

Figure 60: Canadian cervical spine rule in adults - cervical spine injury

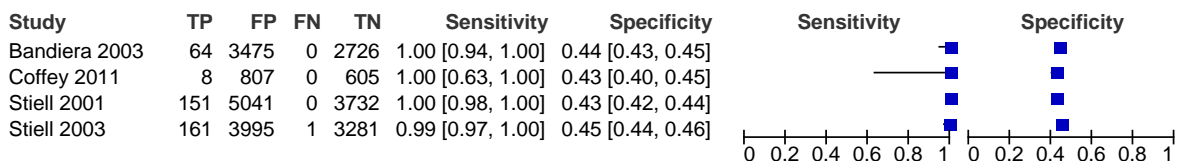

Figure 61: Canadian cervical spine rule in adults (CT as reference standard) - cervical spine injury

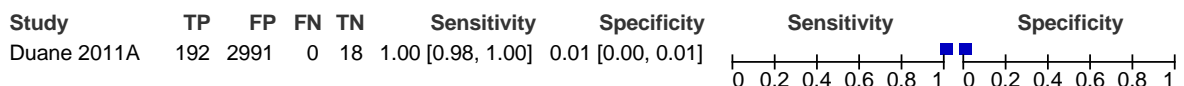

Figure 62: NEXUS criteria in adults - cervical spine injury

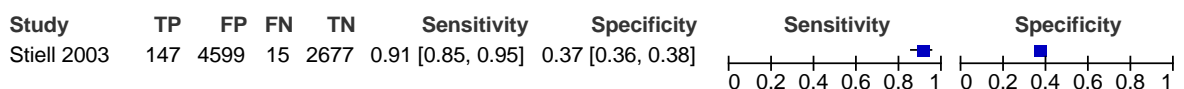

Figure 63: NEXUS criteria in adults (CT as reference standard) - cervical spine injury

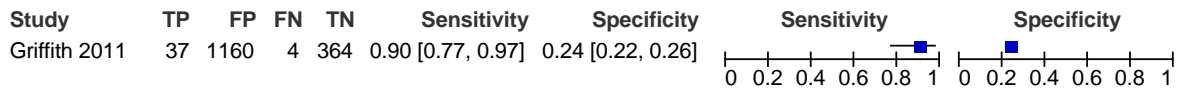
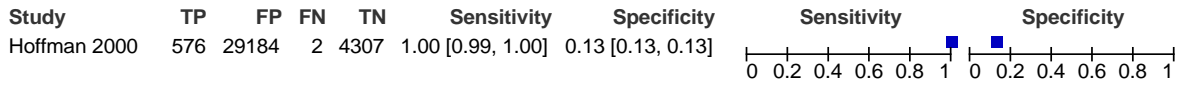

Figure 64: NEXUS criteria, all ages - cervical spine injury



J.3.2 Children and infants – initial imaging

Figure 65: NEXUS criteria in children - cervical spine injury

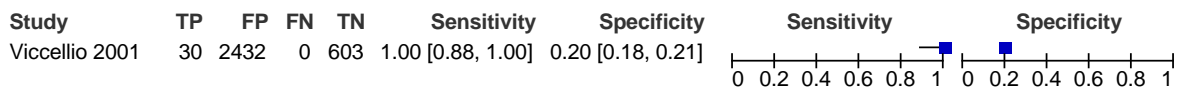
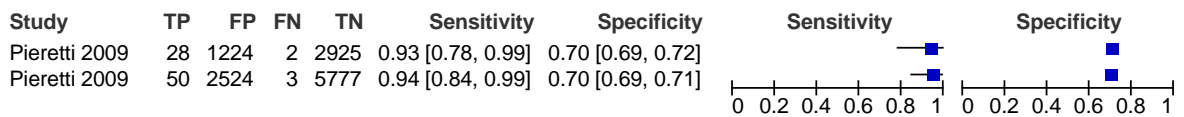

Figure 66: PEDSPINE in infants - cervical spine injury



Appendix K: Excluded clinical studies

Table 19: Direct transport to neuroscience

Reference	Reason for exclusion
Barnett 2013 ²⁹	No data specific to head injury in report
Cheung 2012 ⁷⁶	No data specific to head injury in report
Ciesla 2013 ⁷⁸	No data specific to head injury in report
Cox 2011 & 2012 ^{88,89}	All head injured patients sent direct to a major trauma centre
Cudnik 2012 ⁹¹	Not data specific to head injury, abstract only
Dinh ¹¹¹	No data specific to head injury patients
Domeier 2002 ¹¹³	Immobilised spinal cord injury patients not head injury
Garner 2001 ¹⁵⁸	Uses data from patients presenting at trauma centres. Unclear if this includes all patients triaged prehospital
Hartle 2006 ¹⁸⁹	Not a decision rule or triage tool. Study investigates benefit of direct transport.
Hedges 1987 ¹⁹⁶	No data specific to head injury patients
Henry 1996 ²⁰⁰	No data related to head injury patients
Holmes 2011 ²¹⁶	Specific to motor vehicle accidents. No data related to head injured patients. Abstract only, not much data reported
Kejriwal 2009 ²⁴⁵	Not a decision rule or triage tool. Study investigates benefit of direct transport.
Moen 2008 ³¹⁷	Not a decision rule or triage tool. Study investigates benefit of direct transport.
Moen 2009 ³¹⁸	Not a decision rule or triage tool. Study investigates benefit of direct transport.
Morris 1986 ³²³	Analysis of patients transferred to a trauma centre. Not analysing patients transferred to nearest ED or specialist care
Newgard 2005 ³⁵⁰	Specific to motor vehicle accidents. No data related to head injured patients.
Newgard 2010 ³⁴⁹	Predictors for identifying patients with major trauma. Not about direct transport to specialist care vs transport to nearest ED
Newgard 2011 ³⁵¹	Predictors for identifying patients with major trauma. Not about direct transport to specialist care vs transport to nearest ED
Ornato 1985 ³⁶⁷	No data specific to head injury patients
Pickering 2011 ³⁹⁶	Not about decision rules or triage tools. Systematic review assessing the benefit of direct transfer
Purtill 2008 ⁴⁰⁷	No data specific to head injury patients
Sampalis 1997 ⁴³⁷	Not a decision rule or triage tool. Study investigates benefit of direct transport.
Simons 2010 ⁴⁷⁰	Not a decision rule or triage tool. Study investigates benefit of direct transport.
Sollid 2003 ⁴⁷⁷	Not a decision rule or triage tool. Study investigates benefit of direct transport.
Subaiya 2012 ⁵⁰¹	Not about transport to hospital
Tiesman 2007 ⁵¹³	Not a decision rule or triage tool. Study investigates benefit of direct transport.
Wuerz 1996 ⁵³⁸	Air transport triage tool. No data specific to head injury patients

Table 61: Clinical decision rules for imaging the head

Reference	Reason for exclusion
Agrawal 2012 ⁸	Abstract only. No useable diagnostic data.
Beaudin 2007 ³⁷	Incorrect study design, no useable diagnostic data
Bin 2010 ⁴⁶	Reference standard does not meet protocol
Brehaut 2010 ⁵⁷	Incorrect study design, no useable diagnostic data
Brown 2011 ⁶⁶	Review
Dehdari 2010 ¹⁰³	Abstract only. No useable diagnostic data.
Fabbri 2008a ¹³⁵	No relevant index test or reference standard
Fabbri 2008 ¹³⁴	Incorrect study design (prognostic rather than diagnostic)
Forsyth 2006 ¹⁴⁶	Discussion paper
Kerr 2007 ²⁴⁸	No useable diagnostic data
Maas 2007 ²⁸⁴	No relevant index test or reference standard
Mannix 2010 ²⁹¹	No useable diagnostic data
Mittal 2009 ³¹⁴	Incorrect study design (case report)
Morton 2011 ³²⁴	Abstract only. No useable diagnostic data.
Murray 2007 ³³⁴	No relevant index test or reference standard
Nelson 2010 ³⁴⁷	No relevant index test or reference standard
Norlund 2006 ³⁵⁸	No relevant index test or reference standard
Papa 2012 ³⁸⁶	Incorrect reference standard
Perel 2009 ³⁹³	No relevant index test or reference standard
Rodrigues 2011 ⁴²²	Abstract only. No useable diagnostic data.
Schachar 2011 ⁴⁴⁰	Reference standard does not meet protocol
Sharif-Alhoseini 2011 ⁴⁶³	No useable diagnostic data
Zonmw 2005 ⁵¹⁰	Non-English language

Table 62: Anticoagulants and antiplatelets

Reference	Reason for exclusion
Ahmed 2009 ⁹	All patients have confirmed intracranial lesion
Ahmed 2010 ¹⁰	Not about patients with head injury on anticoagulation or antiplatelet treatment
Alrajhi 2010 ¹⁴	Not everyone scanned. Not enough data in abstract to assess study. Not all patients followed up.
Barbosa 2012 ²⁸	Study about updating a guideline, not about anticoagulation therapy
Batchelor 2012 ³¹	Systematic review of studies excluded from review
Batchelor 2013 ³²	Systematic review of studies excluded from review
Brewer 2011 ⁵⁹	No indication that patients were followed up

Reference	Reason for exclusion
Claudia2011 ⁸¹	Does not report data relating to intracranial lesions in anticoagulated patients with LOC or amnesia
Cohen2006 ⁸³	Not reported how patients were selected for CT scanning. No indication of follow up of patients without CT other than if they returned to hospital. No indication of follow up period for patients.
Fabbri 2010 ¹³⁸	Study not exclusively about antiplatelet or anticoagulation therapy. It excluded clopidogrel and included an NSAID
Fabbri 2013 ¹³¹	All patients have confirmed intracranial lesion
Fortuna2008 ¹⁴⁷	All patients have confirmed intracranial lesion
Franko2006 ¹⁴⁹	Does not report data relating to intracranial lesions in anticoagulated patients with LOC or amnesia
Garra1999 ¹⁵⁹	None of the patients have intracranial lesions
Gittleman2005 ¹⁶⁴	Only includes anticoagulated patients who had a CT scan but unclear what criteria were for selecting patients for CT scan or what happened to anticoagulated patients who did not have a CT scan. Timing of scan and follow up period not reported.
Grandhi2008 ¹⁷⁰	No data for intracranial lesions
Howard2009 ²²⁰	Not exclusively head injury and proportion of head injured patients not reported. Does not assess for intracranial bleeding.
Ivascu2006 ²²⁸	All patients have confirmed intracranial lesion
Ivascu2008 ²²⁷	All patients have confirmed intracranial lesion
Kaen2010 ²³⁷	Only includes anticoagulated patients who had a negative initial CT scan. No data reported for anticoagulated patients with no loss of consciousness or amnesia with a positive initial CT scan.
Kalina2008 ²³⁹	All patients have confirmed intracranial lesion
Lavoie2004 ²⁶²	No data for anticoagulated patients with no loss of consciousness or amnesia.
Lee et al, 2011 ²⁶⁴	Study of children with any bleeding disorders, including anticoagulation therapy. CT at discretion of physician, unclear how many were selected for CT scanning.
Leiblich2011 ²⁶⁶	Narrative review
Li2001 ²⁷¹	Only includes anticoagulated patients who had a CT scan but unclear what criteria were for selecting patients for CT scan or what happened to anticoagulated patients who did not have a CT scan. Timing of scan and follow up period not reported.
Lohrer ²⁸⁰	Not about anticoagulation or antiplatelet therapy
Major2009 ²⁸⁸	Includes anticoagulated patients who had a CT scan but unclear what criteria were for selecting patients for CT scan. Timing of follow up period not reported. No analysis for predictors.
Melville2012 ³⁰⁰	Does not report data relating to intracranial lesions in anticoagulated patients with LOC or amnesia
Menditto2012 ³⁰³	Only includes anticoagulated patients who had a negative initial CT scan. No data reported for anticoagulated patients with no loss of consciousness or amnesia with a positive initial CT scan.
Mina2003 ³¹²	Unclear how many patients in study had a CT scan. No follow up reported.
Nishijima2010 ^{353,355}	All patients have confirmed intracranial lesion
Nishijima2012 ^{354,357}	Patients excluded if no CT scan obtained. Data relating to intracranial lesions with no loss of consciousness or amnesia not reported.
Nishijima2013 ³⁵⁶	Patients excluded if no CT scan obtained.
Ott2010 ³⁷²	About blunt injury to thorax or abdomen
Peck2011 ³⁹¹	Only includes anticoagulated patients who had a negative initial CT scan. No data

Reference	Reason for exclusion
	reported for anticoagulated patients with no loss of consciousness or amnesia with a positive initial CT scan.
Pieracci2007 ³⁹⁸	Patients only selected for study if they had a CT scan. Unclear how patients were selected for CT scan.
Prowse2010 ⁴⁰⁵	Not all patients CT scanned. Unclear how patients selected for CT scanning. Not reported what happened to patients not scanned.
Quintana et al, 2012 ⁴⁰⁹	Retrospective descriptive study. Unclear if all patients were scanned.
Rendell 2012 ⁴¹³	Retrospective review of anticoagulated patients who were selected for CT. Unclear if there were anticoagulated patients who were not selected for CT.
Reynolds2003 ⁴¹⁵	Not all patients scanned. Followed patients up at 6 months to see if alive but no indication if they asked about intracranial lesions or need for neurosurgery.
Salottolo2011 ⁴³⁵	Investigates stopping thromboprophylaxis in traumatic brain injury
Schaller2010 ⁴⁴¹	Excludes patients using anticoagulation treatments
Siracuse2010 ⁴⁷¹	All patients have confirmed intracranial lesion
Spektor2003 ⁴⁷⁸	State of consciousness unknown in a third of aspirin patients.
Tauber2009 ⁵⁰⁴	Only includes anticoagulated patients who had a negative initial CT scan. No data reported for anticoagulated patients with no loss of consciousness or amnesia with a positive initial CT scan.
Taylor 2012 ⁵⁰⁶	Investigates the benefit of delayed CT scanning
Wong 2008 ⁵³⁵	Only patients with evidence of intracranial injury included

Table 63: Biomarkers

Reference	Reason for exclusion
Bechtel 2009 ³⁸	Inadequate reference standard
Egeaguerrero 2010 ¹²⁴	Abstract only, no useable diagnostic data
Filippidis 2010 ¹⁴²	Non-systematic review
Gradisek 2011 ¹⁶⁹	Abstract not freely available
Hallen 2010 ¹⁸¹	Inadequate reference standard
Herrmann 2000 ²⁰²	Inadequate index test (blood sample taken >6 hours after injury)
Honda 2010 ²¹⁹	Incorrect setting - not in emergency department (admitted to intensive care > 2 days)
Ingbrigtsen 2000 ²²⁵	Inadequate index test (blood sample taken >6 hours after injury)
Jeromin 2012 ²³⁶	Abstract only, no useable diagnostic data
Kotlyar 2011 ²⁵⁴	Inadequate index test (diagnostic accuracy data based on cohort where not all patients received the index test)
Lange 2012 ²⁶⁰	Inadequate index test (blood sample taken within >6 hours after injury)
Levitt 1995 ²⁶⁹	No relevant index test
Lee 2010 ²⁶⁵	No useable diagnostic data
Lind 2011 ²⁷³	Abstract only

Reference	Reason for exclusion
Lumpkins 2008 ²⁸³	Incorrect setting - not in emergency department (intensive care)
Mercier 2012 ³⁰⁵	Abstract only, no useable diagnostic data
Muller 2007 ³³²	Inadequate index test (blood sample taken within >6 hours after injury)
Mussack 2000 ³³⁹	No useable diagnostic data
Naeimi 2006 ³⁴⁰	Inadequate index test (blood sample taken within >6 hours after injury)
Oh 2007 ³⁶³	Incorrect population - includes non-traumatic brain injury
Papa 2011A ³⁸²	Abstract only, no useable diagnostic data
Papa 2012 ³⁸⁵	Non-systematic review
Papa 2013A ³⁸⁴	Abstract only, no useable diagnostic data
Papa 2013B ³⁸³	Abstract only, no useable diagnostic data
Pickering 2010 ³⁹⁵	Abstract only, no useable diagnostic data
Pickering 2011 ³⁹⁷	Non-systematic review
Romner 2000 ⁴²³	Inadequate index test (blood sample taken within >6 hours after injury)
Schiavi 2012 ⁴⁴⁴	Non-systematic review
Tavarez 2012 ⁵⁰⁵	Non-systematic review
Zurek 2012 ⁵⁴³	No useable diagnostic data (predominantly a prognostic study)

Table 64: Clinical decision rules for cervical spine imaging – initial imaging

Reference	Reason for exclusion
Ackland 2011 ¹	Incorrect population. The inclusion and exclusion criteria do not meet our protocol and therefore this paper is not applicable to our population.
Bailitz 2009 ²³	Incorrect index test - not a clinical decision rule
Brehaut 2006 ⁵⁸	Incorrect study design - abstract only
Ehrlich 2009 ¹²⁶	Incorrect study design - diagnostic case-control
Eubanks 2006 ¹³⁰	Incorrect study design - non-systematic review
Fehlings 2011A ¹⁴¹	Incorrect study design - summary of a review
Garton 2008 ¹⁶⁰	Incorrect population - all patients have c-spine injury
Gonzalez 2009 ¹⁶⁶	Incorrect index test - not a clinical decision rule
Halpern 2010 ¹⁸³	Incorrect study design - non-systematic review
Hennessy 2010 ¹⁹⁹	Incorrect index test - not a clinical decision rule
Hutchings 2009 ²²³	Incorrect setting - intensive care
Kaiser 2012 ²³⁸	Retrospective, no useable diagnostic data
Leonard 2011 ²⁶⁷	Incorrect study design - diagnostic case-control
Michaleff 2012 ³⁰⁶	Non systematic review
Moak 2011 ³¹⁶	Incorrect study design - survey of emergency physicians
Ong 2006 ³⁶⁵	No useable diagnostic data
Panczykowski 2011 ³⁷⁸	Incorrect study design - non-systematic review
Perry 2006 ³⁹⁴	Incorrect study design - non-systematic review

Reference	Reason for exclusion
Rethnam 2008 ⁴¹⁴	No useable diagnostic data
Saltzherr 2010 ⁴³⁶	No useable diagnostic data
Schoenwalder2009 ⁴⁴⁶	Incorrect setting - intensive care
Sheikh 2012 ⁴⁶⁶	No useable diagnostic data
Stassen 2006 ⁴⁷⁹	Incorrect setting - intensive care
Stelfox 2007 ⁴⁸⁹	Incorrect setting - intensive care
Tilt 2012 ⁵¹⁴	Incorrect study design - non-systematic review
Tran 2013 ⁵¹⁹	Abstract, no useable diagnostic data

Table 65: Clinical decision rules for cervical spine imaging – further imaging

Reference	Reason for exclusion
Avellino 2005 ²⁰	Reasons for mis-diagnosis of c-spine injuries in infants and children, error rate. No useable data on predictors.
Adams 2006 ³	Evaluation of c-spine clearance protocol (not based on a prognostic study), no comparison of this unreliable subgroup to all patients.
Albrecht 2001 ¹³	No useable diagnostic data or predictors.
Bachulis 1987 ²²	Data of c-spine radiographs and missed cases. No useable data on predictors.
Banit 2000 ²⁶	Incidence data of c-spine radiographs, implementation of a protocol.
Barba 2001 ²⁷	Implementation of a c-spine protocol using CT.
Benzel 1996 ⁴⁰	No useable diagnostic data or predictors.
Blackmore 2003 ⁴⁷	Non systematic review of c-spine imaging/rules.
Como 2011 ⁸⁶	Evaluation of c-spine clearance protocol (not based on a prognostic study), no comparison of this unreliable subgroup to all patients.
Como 2007 ⁸⁵	Evaluation of c-spine clearance protocol (not based on a prognostic study), no comparison of this unreliable subgroup to all patients.
Cooper 2005 ⁸⁷	Narrative review and discussion about clearing the c-spine in unconscious head injured patient.
Dalise 1999 ⁹⁴	No useable diagnostic data or predictors.
Dare 2002 ⁹⁶	SCIWORA - case series, detailing MRI findings (no comparison to all patients/patients without SCIWORA).
Davis 1993 ⁹⁹	Data of c-spine radiographs and missed cases (clinical error, inadequate views). No useable data on predictors.
Dickinson 2004 ¹⁰⁷	NEXUS low risk criteria retrospective validation.
Freedman 2005 ¹⁵⁰	Assessing a protocol in unconscious, uncooperative patients.
Gale 2005 ¹⁵⁷	Details of patients undergoing radiography and then CT. No useable data on predictors.
Ghanta 2002 ¹⁶²	Eastern guidelines and c-spine evaluation in patients (persistent neck pain, neurologic deficits, obtunded).
Goodnight 2008 ¹⁶⁸	Incorrect index test.
Hendey 2002 ¹⁹⁷	No comparison to all patients/patients without SCIWORA. No useable diagnostic data or predictors.
Hogan 2005 ²¹²	Evaluation of c-spine clearance protocol (not based on a prognostic study), no comparison of this unreliable subgroup to all patients.
Jaffe 1987 ²³⁰	No useable diagnostic data or predictors.
Kasimatis 2008 ²⁴⁰	SCIWORA - case series, detailing MRI findings (no comparison to all patients/patients without SCIWORA).

Reference	Reason for exclusion
Keiper 1998 ²⁴⁴	No useable diagnostic data or predictors.
Kriss 1996 ²⁵⁶	Review of SCIWORA in children - clinical findings.
Mahmood 2010 ²⁸⁷	Not a clinical decision rule, No useable diagnostic data or predictors.
McCulloch 2005 ²⁹⁴	Not a clinical decision rule, No useable diagnostic data or predictors.
Menaker2008 ³⁰¹	Evaluation of c-spine clearance protocol (not based on a prognostic study), no comparison of this unreliable subgroup to all patients.
Menaker2010 ³⁰²	Evaluation of c-spine clearance protocol (not based on a prognostic study), no comparison of this unreliable subgroup to all patients.
Mower 2001 ³²⁸	Data of c-spine radiographs and missed cases. No useable data on predictors.
Muchow 2008 ³³⁰	Non systematic review.
Osenbach 1989 ³⁶⁸	No comparison to all patients/patients without SCIWORA. No useable diagnostic data or predictors.
Panacek 2001 ³⁷⁷	Individual NEXUS criteria test performance.
Pang 2004 ³⁸⁰	Non systematic review of SCIWORA in children.
Sarani 2007 ⁴³⁸	Evaluation of c-spine clearance protocol (not based on a prognostic study), no comparison of this unreliable subgroup to all patients.
Schoenfeld 2010A ⁴⁴⁵	Meta-analysis of CT vs CT and MRI in imaging occult injuries to c-spine.
Schuster 2005 ⁴⁴⁹	No useable diagnostic data or predictors.
Schuster 2005A ⁴⁵⁰	C-spine injury detected by CT, subsequent MRI conducted (positive initial imaging, therefore does not meet review question).
Sharma 2009 ⁴⁶⁵	SCIWORA - case series, detailing MRI findings (no comparison to all patients/patients without SCIWORA).
Steigelman2008 ⁴⁸⁰	Evaluation of c-spine clearance protocol (not based on a prognostic study), no comparison of this unreliable subgroup to all patients.
Thomas 2002 ⁵¹¹	Short review of CT for c-spine injury in trauma patients with an altered mental state.
Tomycz 2008 ⁵¹⁶	Evaluation of c-spine clearance protocol (not based on a prognostic study), no comparison of this unreliable subgroup to all patients.

Table 66: Patient information and discharge advice

Reference	Reason for exclusion
Aitken 2004 ¹¹	Population does not match protocol (broader than head injury/TBI)
Friedemann 2008 ¹⁵³	Incorrect study design (non-systematic review)
Hawley 2003 ¹⁹³	Does not meet protocol (long term consequences of severe traumatic brain injury and long term follow up needs and assessments)
Hokenstad 2006 ²¹³	Population does not match protocol (includes stroke patients)
Kerr 2007 ²⁴⁹	Does not meet protocol (no information on patient views, audit data only)
Liddle 2011 ²⁷²	Does not meet protocol (adults with TBI requiring hospital inpatient treatment and rehabilitation).
Moore 2004 ³²⁰	Does not meet protocol (no information on patient views, audit data only)
Mosconi 2011 ³²⁵	Incorrect setting (discharge from rehabilitation centre)
Murray 2006 ³³⁵	Population does not match protocol (acquired brain injury)
Nalder 2012 A ³⁴²	Not related to discharge advice - factors associated with transition from hospital to home.
Nalder 2012 B ³⁴³	Not related to discharge advice - factors associated with transition from

Reference	Reason for exclusion
	hospital to home.
Ocallaghan 2011 ³⁶⁰	Does not meet protocol (exploring carers perspectives on rehabilitation)
Omalley 2011 ³⁶¹	Not directly applicable to question - Implementation of a TBI educational model.
Pegg 2005 ³⁹²	Does not meet protocol (relates to rehab outcomes, not discharge from ED)
Turner 2007 ⁵²²	Population does not match protocol (acquired brain injury)
Turner 2008 ⁵²³	Incorrect study design (non-systematic review)
Turner 2011 ⁵²⁴	Population does not match protocol (acquired brain injury)
Tyers 2011 ⁵²⁵	Abstract only

Appendix L: Excluded economic studies

Table 67: Clinical decision rules for imaging the head

Reference	Reason for exclusion
Excluded Studies identified in the 2014 update.	
Campbell 2007 ⁶⁹	<p>Early diagnosis of inflicted traumatic brain injury as a way to reduce morbidity and mortality associated with repeated inflicted traumatic brain injuries. Study estimates the cost-effectiveness of a policy of head computed tomography (CT) for inflicted traumatic brain injury in selected infants seen in an emergency department.</p> <p>Excluded because not relevant population.</p>
Norlund 2006 ³⁵⁸	<p>Cost analysis of immediate computed tomography during triage for admission versus observation in hospital. Study set in Sweden.</p> <p>Excluded due to the availability of directly applicable economic evidence based on a cost-utility analysis.</p>
Smits 2010 ⁴⁷⁵	<p>CUA set in the Netherland. Societal perspective adopted. The study was excluded due to its partial applicability and to its very serious limitations, as the findings of the probabilistic sensitivity analysis contradicted those of the deterministic analysis (the CCHR was found cost-effective in the former case, and the CHIP rule in the latter).</p>
Stein 2008 ⁴⁸³	<p>Cost-effectiveness of routinely re-scanning patients compared with repeating the scan only after a clinical deterioration for patients in which the initial scan revealed an intracranial abnormality which did not require surgery. Model set in the US system; a societal perspective was adopted. The study findings are greatly uncertain, with routine CT scanning ranging from dominant to being dominated in a probabilistic sensitivity analysis. The study did not explore the source of this uncertainty. Moreover, the risk of cancer from radiation was not modelled in the study.</p> <p>Excluded due to the availability of directly applicable economic evidence based on a cost-utility analysis.</p>
Studies included in 2007 Head injury update, but selectively excluded in the 2014 update.	
Hassan 2005 ¹⁹²	<p>A UK costing of the implementation of the 2003 guideline that compared the X-ray and admission based practice with the Canadian CT head rule and directly applicable to the UK. This study was selectively excluded in the 2014 update due to the availability methodologically sounder cost-utility evidence comparing a wider range of clinical decision rules (Pandor et al, 2011).</p>
Shravat 2006 ⁴⁶⁷	<p>A UK cohort study with costing examining the implementation of the 2003 guideline costs were found to increase by £77 per patient with the Canadian CT head rule. This study was selectively excluded in the 2014 update due to the availability of methodologically sounder cost-utility evidence comparing a wider range of clinical decision rules (Pandor et al, 2011).</p>

Reference	Reason for exclusion
Stein 2006 ⁴⁸⁸	A decision analysis that compared the Canadian CT head rule with several strategies including 'CT all', 'admit all', 'discharge all' and 'X-ray all' in a US context. Quality-adjusted life-years (QALYs) and costs were estimated for both prompt and delayed surgery by comparing the mortality and recovery rates in different case series. This study was selectively excluded in the 2014 update due to the availability of directly applicable and methodologically sounder cost-utility evidence comparing a wider range of clinical decision rules (Pandor et al, 2011).

Table 68: Biomarkers

Reference	Reason for exclusion
Ruan 2009 ⁴³¹	A cost analysis looking at the potential savings of using the S100B in an emergency department to screen patients as a way to identify those requiring CT scan of the head. This study has been excluded due to the cost calculations rely entirely on a health care system profoundly different from the UK NHS, and therefore it was felt inappropriate to extrapolate its findings to the UK health care setting.

Appendix M: Cost-effectiveness analysis: Cervical spinal injury clearance strategies

M.1 Methods

M.1.1 Model overview

Head injury (HI) patients can sustain bony and/or soft tissue injuries to the cervical (C) spine. Whether patients experience a soft tissue injury becomes relevant after the initial imaging shows a bony injury, or if the initial imaging is negative but the clinical picture still suggests that there is a high risk of a cervical spine injury (CSI), in which case patients will experience solely a soft tissue injury of the C-spine.

CG56 included a tentative cost analysis on this topic, with the comparison between the NEXUS and the Canadian CT rule for CSI prediction. It was estimated that the Canadian rule could save from £4 to £14 per patient to the NHS. However, this cost analysis had limited validity due to the use of overseas data and simplified assumptions with regards to dealing with indeterminate diagnostic imaging results.

The management of patients with HI and suspected CSI is particularly challenging in terms of resource implications. The main trade offs for this topic are represented by the cost of the diagnostic tests (whether X-ray, CT scan and MRI) versus the failure to detect their CSI (false negatives).

The guidelines update of the CG56 literature review found no new economic evidence since the publication of CG56 on the cost-effectiveness of clinical prediction rules for any of the clinical questions for this topic.

As a consequence, the GDG has identified this topic as a high priority for an original economic analysis.

The economic analysis will address the following clinical question:

Q1. What is the best clinical prediction rule for determining which patients with head injury should be imaged (initial imaging with X-ray or CT) for cervical spine injury?

M.1.1.1 Comparators

Seven clearance strategies for patients with HI and suspected CSI were devised to allow for differential use of diagnostic imaging.

The strategies compared in this cost-effectiveness analysis are:

- **CT on all:** In this strategy, no prediction rule is used. Everyone with HI and suspected CSI is given a CT scan.
- **X-ray on all:** In this strategy, no prediction rule is used. Everyone with HI and suspected CSI is given an X-ray.
- **CT according to NEXUS:** In this strategy, the NEXUS prediction rule is used to determine whether a CT scan is necessary. Only under the direction of the NEXUS prediction rule is a CT scan undertaken.
- **CT according to Canadian C-Spine:** In this strategy, the Canadian C-spine prediction rule is used to determine whether a CT scan is necessary. Only under the direction of the Canadian C-spine prediction rule is a CT scan undertaken.

- **X-ray according to NEXUS:** In this strategy, the NEXUS prediction rule is used to determine whether an X-ray is necessary. Only under the direction of the NEXUS prediction rule is an X-ray undertaken.
- **X-ray according to Canadian C-spine:** In this strategy, the Canadian C-spine prediction rule is used to determine whether an X-ray is necessary. Only under the direction of the Canadian C-spine prediction rule is an X-ray undertaken.
- **No imaging:** In this strategy, patients with HI and suspected CSI do not receive any diagnostic imaging.

The CT on all, X-ray on all, and No imaging strategies were included as theoretical strategies to explore the overall cost-effectiveness of diagnostic imaging. In practice, the first two strategies are not feasible and the last is not acceptable.

M.1.1.2 Population

The population of the model consists of patients over the age of 16 with HI and suspected CSI.

M.1.1.3 Time horizon, perspective, discount rates used

The analysis took the perspective of the UK NHS. The time horizon of the model was one in-hospital episode including diagnosis and treatment, discounting was therefore not applicable.

M.1.1.4 Deviations from NICE reference case

The search for quality of life evidence did not identify any data which the GDG felt applicable to inform the expected health benefits for each diagnostic outcome. With long-term management of CSI patients falling outside of the scope of this guideline, accurate data on the long-term health outcomes and resource use associated with downstream management were not available.

As a compromise, the GDG identified the cost of prevention of a false negative as the most useful outcome for decision making and cautioned the interpretation of results due to the lack of evaluation of all of the trade offs involved between the diagnostic outcomes (such as the benefit of true positives and negatives, and the health cost of the false positive, noting cost of treating a false negative case was included in the analysis). To further assess the net cost of avoiding a false negative, a range of potential litigation costs of a false negative was incorporated in a threshold sensitivity analysis. Also, a conservative hypothetical scenario where minimal QALY gain was associated with a true positive and zero health or monetary cost associated with the false diagnostic outcomes was analysed.

There is divergence from the NICE reference case as the main analysis is a cost-effectiveness analysis (rather than a CUA) assessing the cost per diagnostic outcome in a time horizon limited to the diagnostic workup and short-term management. In addition, we employ the litigation cost which may be associated to a false negative and the underlying assumption that no clinical harm or cost (other than that of initial treatment) is associated to patients who have a false positive test result to assess cost-effectiveness. This further analysis is in essence a cost minimisation analysis.

M.1.1.5 Uncertainty

The base case analysis employs expected values of costs, utilities and probabilities for model parameters and serves as base case analysis. If there are uncertainties about the values and assumptions used in the main cost-effectiveness analysis, sensitivity analyses are conducted. Results from base case and sensitivity analyses are compared.

There are two types of sensitivity analysis.

Deterministic Sensitivity Analysis (DSA) is where the value of one of the parameters is changed to observe any effect on the results. This allows determination of the threshold at which a parameter's value is likely to change the conclusion. The GDG were uncertain about a number of parameters: the prevalence of CSI in a population, the cost of no procedure for patients with and without CSI, the clinical decision for further imaging after an initial X-ray / CT, and the specifications of initial imaging strategies (the probability of being given CT/X-ray/no imaging initially) and these uncertainties were tested by deterministic sensitivity analysis.

Probabilistic Sensitivity Analysis (PSA) is conducted to quantify parameter uncertainty. For every parameter subject to uncertainty (i.e. unit costs, sensitivities and specificities of the prediction rules and clinician estimates), a distribution is assigned to reflect its uncertainty. Random draws across all parameter distributions are undertaken using Monte Carlo methods. This process is repeated many times to build up a simulated sample of the expected value of the model output parameters, as well as a quantification of parameter uncertainty. The PSA will determine the probability an intervention is cost-effective given a particular cost-effectiveness threshold.

M.1.2 Approach to modelling

The model is a decision tree which includes evidence on the prevalence of CSI among patients with head injury as well as on intermediate outcomes (specificity and sensitivity) of all strategies being compared (for example X-rays, CT scans, MRI, prediction rules). The combination of the prevalence of CSI with the specificity and sensitivity of each strategy determines the proportion of patients who have abnormal, indeterminate and normal imaging results. According to diagnostic imaging results, patients undergo a specific type of medical management (observation, immediate discharge or surgical and non-surgical treatment). The model tracks the number of patients for whom the clinical decision is appropriate (TP, TN) or inappropriate (FP, FN).

As there was limited data availability for survival and medical events (such as long term disability) following medical interventions received or not received by patients, the most important health outcome was considered to be the number of false negatives identified by each strategy.

M.1.2.1 Model structure

There are 7 clearance strategies for all patients with HI and suspected CSI regardless of the presence or absence of CSI. These seven strategies are described in M.1.1.1.

For Strategies 1 - 7 where no initial imaging is undertaken, patients are treated as normal, receive no treatment and are either discharged or observed in hospital for a period of 1 week (see Figure 67). If patients have CSI, they may or may not experience deterioration. If patients do not have CSI, they do not experience deterioration.

Figure 67 Model structure for No Initial Imaging

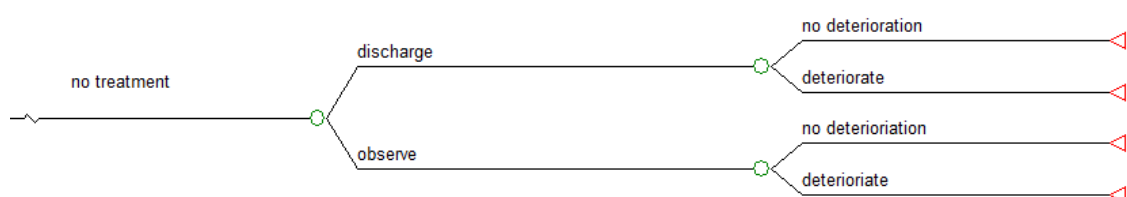

For strategies 2-7 when initial imaging is a CT scan, further imaging may take place according to the initial CT scan result.

If the initial CT result is negative (normal), patients are given no further tests and discharged (see Figure 68).

Figure 68 Model structure for initial CT scan and negative (normal) result



If the initial CT scan result is positive (abnormal), the patient may be treated immediately or provided a further MRI before treatment (see Figure 69).

Figure 69 Model structure for initial CT scan and positive (abnormal) result

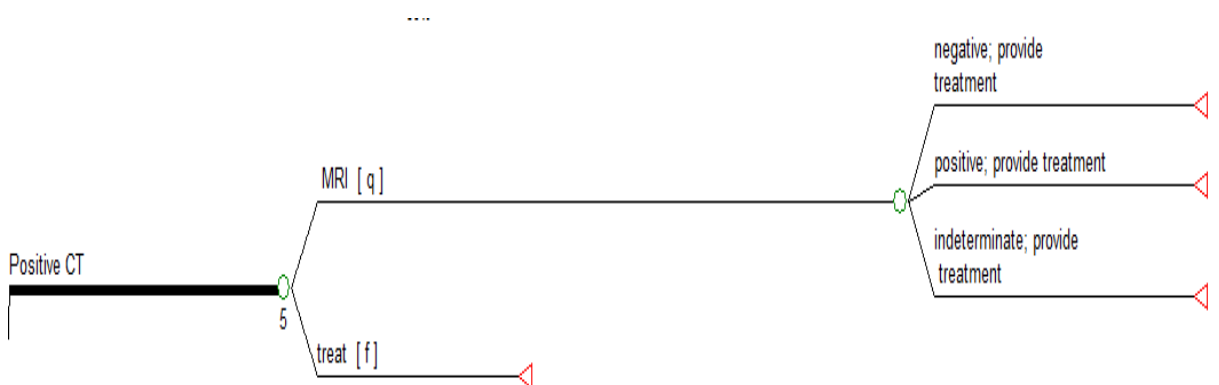

If the initial CT scan is indeterminate (Figure 70), the patient will undergo further diagnostic imaging - MRI or Flexion Extension (FE). If the second diagnostic imaging (MRI/FE) is positive, the patient may be treated immediately or given a third diagnostic scan (MRI/FE). Patients are treated if the third diagnostic scan is positive. Patients are observed in hospital for a one week period if the third diagnostic scan is indeterminate. Patients receive no further diagnostic imaging and are discharged if the third diagnostic scan is negative.

Figure 70 Model structure for initial CT scan and indeterminate result

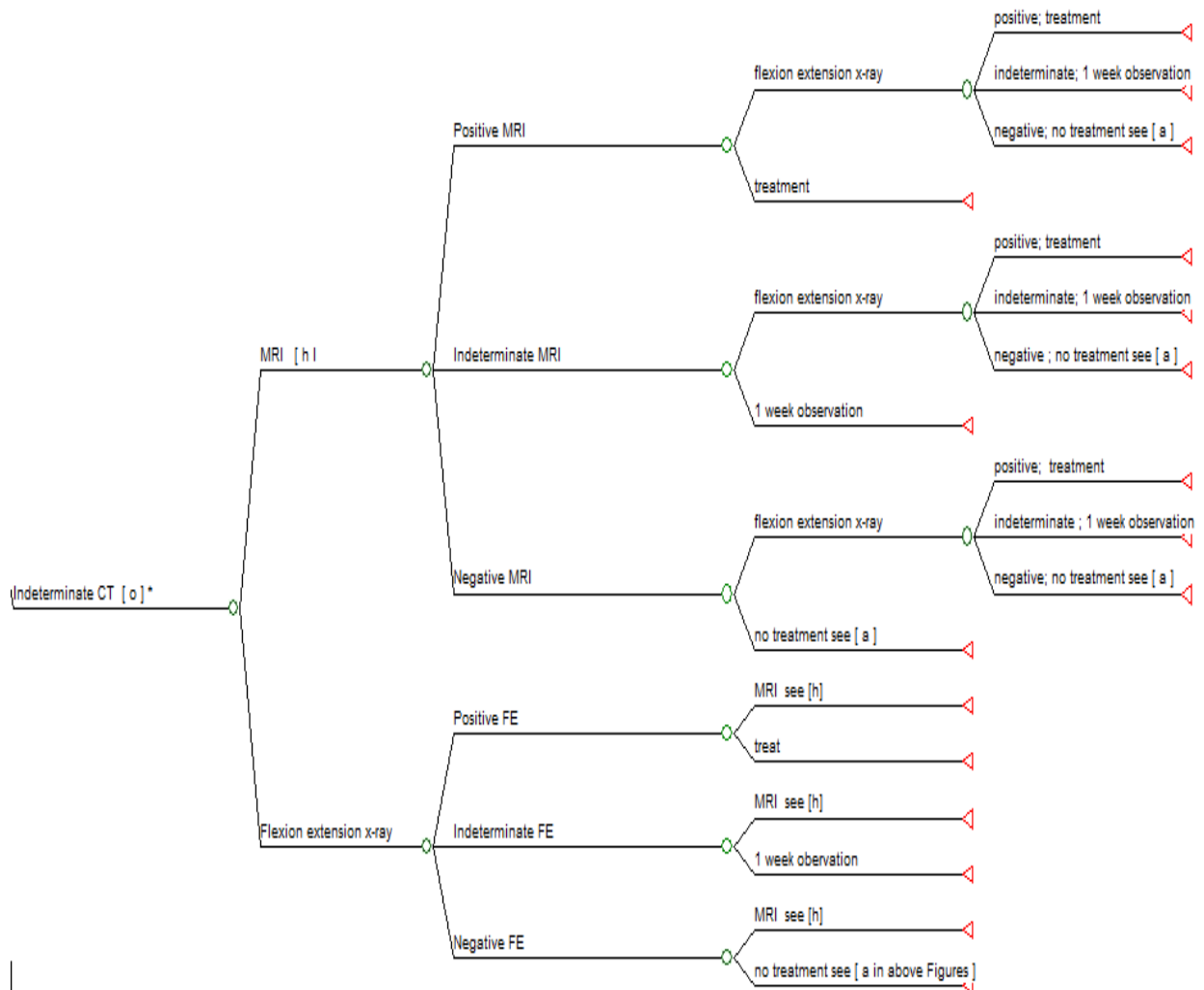

When initial imaging is an X-ray, further imaging can occur according to its results. A negative initial x-ray result warrants no further imaging and patients are either discharged or admitted one week observation in hospital according to clinical judgement (Figure 71).

Figure 71 Model structure for initial X-ray and negative result

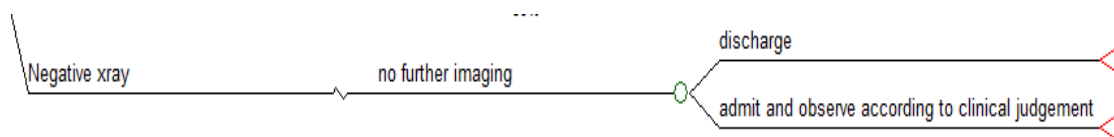

A positive or indeterminate X-ray result requires further imaging (MRI / CT). The model structure following a MRI/CT scan is summarised in Figure 72. As the model structure here is the same as those described and illustrated above, refer to Figure 68, Figure 69, and Figure 70, for details of the model structure following a CT scan and Figure 70, branch [h] for details of the model structure following an MRI).

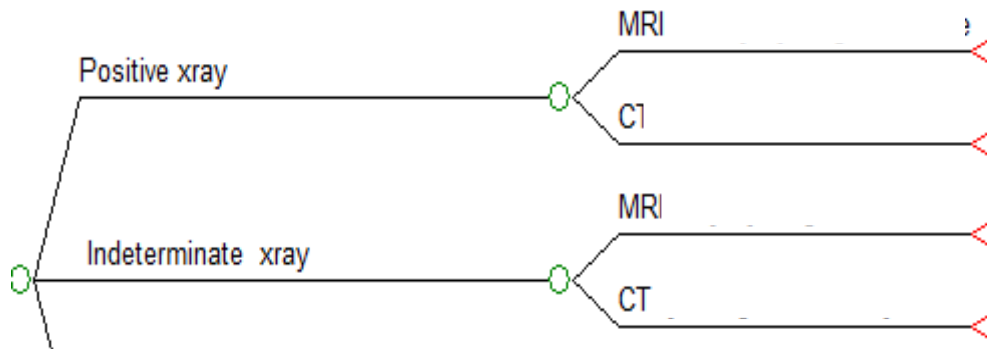
Figure 72 Model structure for initial X-ray and positive / indeterminate result

Patients who need treatment are provided specific procedures according to injury characteristics. Specifically, the GDG judged that the characteristics of a Cervical Spine Injury – bone; ligamentous; compression; stability; and presence of (Cervical Spinal Cord Injury) SCI— would determine the type of treatment required. The tree structure detailed in Figure 73 show the subcategorisation of injury characteristics and the appropriate corresponding procedure.

Patients with complete or partial SCI and compression required a surgical or non-surgical procedure. Those who require surgery receive decompression and, where necessary, fusion. A collar could be provided in the case that a non-surgical procedure is deemed appropriate.

Patients with partial or complete SCI and no compression were treated according to the stability of their injury. When the injury is stable, no procedure was necessary and instead, patients would receive a period of hospital observation. If the injury was unstable, a surgical or non-surgical procedure is required.

Some patients with cervical spine injury will not have SCI. When these patients have stable injuries, then no procedure is required. Instead, they receive a period of hospital observation. However, if these patients sustain an unstable injury, surgical or non-surgical treatment is needed.

Figure 73 Model structure for patients who require treatment

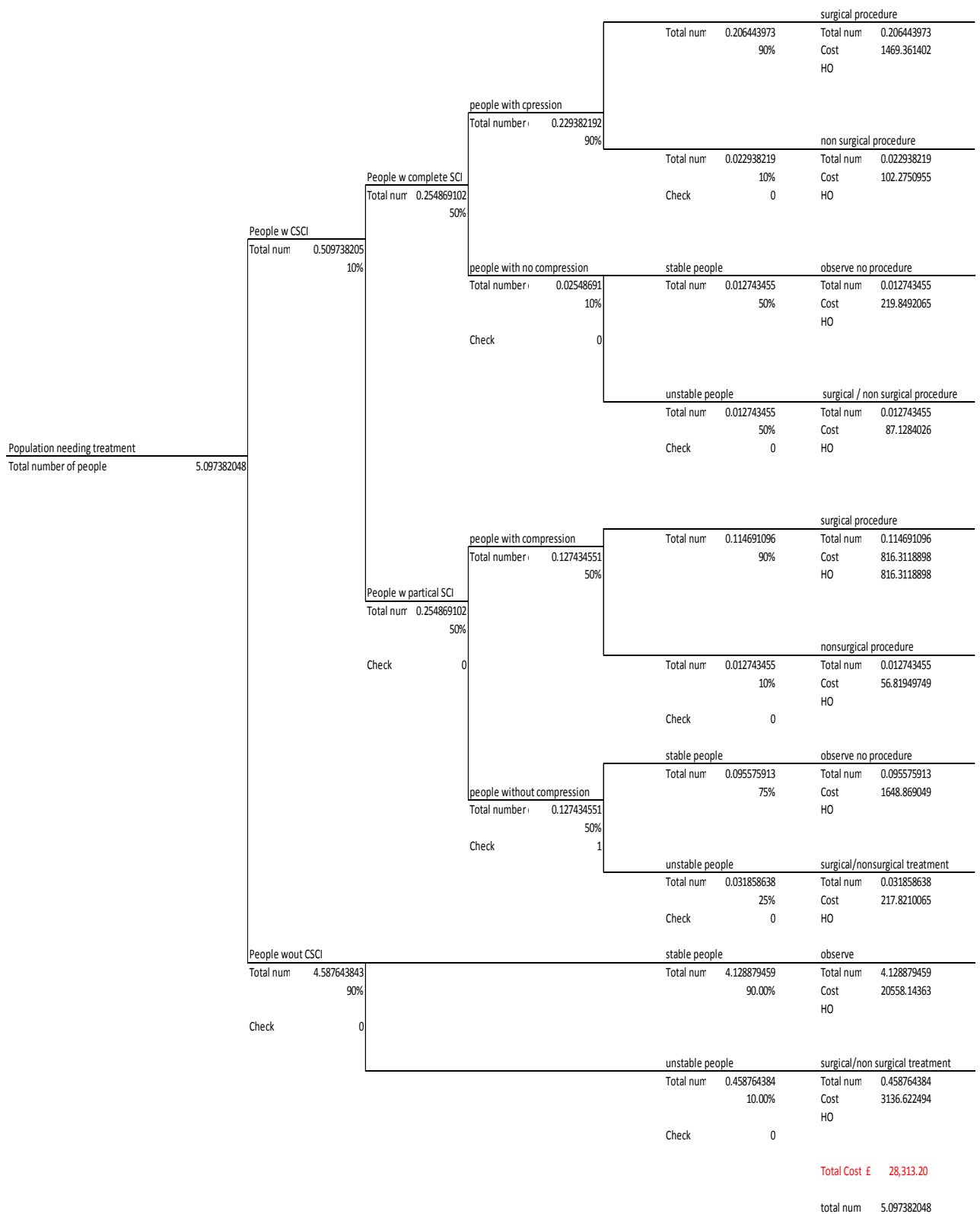

M.1.3 Model inputs

M.1.3.1 Summary table of model inputs

Model parameters were based on clinical evidence identified in the systematic review undertaken for the guideline and supplemented by additional data sources when necessary. For example, a recent economic paper, Harlpen et al., was considered to be the best available source in the absence of a full systematic review on the diagnostic accuracy of the imaging modalities contained within the model. The authors had conducted a systematic search on these parameters, and several sources were used to inform the estimates used.

Model inputs were validated with clinical members of the GDG. In all but one instance only one source was identified in the clinical review to inform accuracy estimates of the clinical decision rules. In the case of the rule to xray by Canadian C-spine there was more than one source identified. In clinical validation of the sources in regards to their applicability and quality, the developers considered Coffey et al. to be the only appropriate source to inform the model for the following reasons. Throughout the guideline the developers placed more emphasis on recent UK studies, with Coffey et al. being the only source for this parameter to be both derived and validated in the UK context.

A summary of the model inputs used in the base case (primary) analysis are provided in below. More details about sources, calculations and rationale for selection can be found in the sections following this summary table.

Table 69: Summary of base-case and sensitivity analysis model inputs

Parameter description	Deterministic estimate	Probability distribution	Distribution parameters	Source
Cohort Settings				
Patients with HI and no CSI/with HI and CSI	99.5%/0.5%	-	-	GDG Expert Opinion
Cost of Prediction Rules (£)				
Canadian C-spine	£0	-	-	Criteria are freely accessible
NEXUS	£0	-	-	
Cost of Diagnostic Imaging (£)				
X-ray	£30	Best fit distribution identified according to methods described in section M.1.4, Table 70 .		Calculated from 2011-2012 NHS reference cost codes DAPF ¹⁰⁴
Flexion, extension X-ray	£60			Calculated from 2011-2012 NHS reference cost codes DAPF and according to GDG Expert Opinion ¹⁰⁴
CT	£104			Calculated from 2011-2012 NHS reference cost codes RA08A, RA11Z and RA13Z ¹⁰⁴
MRI	£182			Calculated from 2011-2012 NHS reference cost codes RA01A & RA04Z ¹⁰⁴
No imaging	£0			N/A
Cost of Treatment (£)				

Parameter description	Deterministic estimate	Probability distribution	Distribution parameters	Source
Surgical procedure	£7,117	Best fit distribution identified according to methods described in section M.1.4, Table 70 .		Calculated from 2011-2012 NHS reference cost code HC01-HC04 ¹⁰⁴
Surgical or Non-Surgical Procedure	£6,837			Calculated from 2011-2012 NHS reference cost code HC01-HC06 ¹⁰⁴
Non –Surgical Procedure	£ 4,459			Calculated from 2011-2012 NHS reference cost codes HC05-HC06 ¹⁰⁴
No procedure, (patients with SCI)	£17,252			Calculated from 2011-2012 NHS reference cost codes HC21B, ¹⁰⁴
No Procedure, (patients with no SCI)	£4,979			Calculated from 2011-2012 NHS reference cost code HC21C ¹⁰⁴
Deterioration after treatment	£7,214			GDG Expert Opinion
Discharge	£0			
Performance of Prediction Tools				
Canadian C-spine X-ray - Sensitivity	1.00	Beta	$\alpha = 8, \beta = 0$	Clinical Review- Coffey 2011 ⁸²
Canadian C-spine X-ray - Specificity	0.43	Beta	$\alpha = 605, \beta = 807$	
Canadian C-spine CT - Sensitivity	1.00	Beta	$\alpha = 192, \beta = 0$	Clinical Review- Duane 2011A ¹¹⁵
Canadian C-spine CT - Specificity	0.06	Beta	$\alpha = 18, \beta = 2991$	
NEXUS X-ray - Sensitivity	0.91	Beta	$\alpha = 147, \beta = 15$	Clinical Review- Stiell 2003 ⁴⁹²
NEXUS X-ray - Specificity	0.37	Beta	$\alpha = 2677, \beta = 4599$	
NEXUS CT - Sensitivity	0.90	Beta	$\alpha = 37, \beta = 4$	Clinical Review- Griffith 2011 ¹⁷⁴
NEXUS CT - Specificity	0.24	Beta	$\alpha = 364, \beta = 1160$	
Performance of X-ray				
Sensitivity	0.568	Beta	$\alpha = 334, \beta = 254$	Clinical Review- Halpern 2010 ¹⁸³
Normal results which are indeterminate	80%	Beta	$\alpha = 800, \beta = 200$	GDG Expert Opinion
Abnormal results which are indeterminate	10%	Beta	$\alpha = 100, \beta = 900$	
Specificity	0.997	Beta	$\alpha = 45822, \beta = 138$	Clinical Review- Halpern 2010 ¹⁸³
Normal results which are indeterminate	10%	Beta	$\alpha = 100, \beta = 900$	GDG Expert Opinion
Abnormal results which are indeterminate	80%	Beta	$\alpha = 800, \beta = 200$	

Parameter description	Deterministic estimate	Probability distribution	Distribution parameters	Source
Performance of CT				
Sensitivity	0.832	Beta	$\alpha = 1545, \beta = 312$	Clinical Review- Halpern 2010 ¹⁸³
Normal results which are indeterminate	90%	Beta	$\alpha = 900, \beta = 100$	GDG Expert Opinion
Abnormal results which are indeterminate	10%	Beta	$\alpha = 100, \beta = 900$	
Specificity	0.999	Beta	$\alpha = 15335, \beta = 15$	Clinical Review- Halpern 2010 ¹⁸³
Normal results which are indeterminate	10%	Beta	$\alpha = 100, \beta = 900$	GDG Expert Opinion
Abnormal results which are indeterminate	90%	Beta	$\alpha = 900, \beta = 100$	
Performance of MRI				
Sensitivity	0.867	Beta	$\alpha = 386, \beta = 59$	Clinical Review- Halpern 2010 ¹⁸³
Normal results which are indeterminate	10%	Beta	$\alpha = 100, \beta = 900$	GDG Expert Opinion
Abnormal results which are indeterminate	0%			
Specificity	0.997	Beta	$\alpha = 565, \beta = 2$	Clinical Review- Halpern 2010 ¹⁸³
Normal results which are indeterminate	10%	Beta	$\alpha = 100, \beta = 900$	GDG Expert Opinion
Abnormal results which are indeterminate	0%			
Performance of FE-X-ray				
Sensitivity	0.568	Beta	$\alpha = 334, \beta = 254$	Clinical Review- Halpern 2010 ¹⁸³
Normal results which are indeterminate	70%	Beta	$\alpha = 700, \beta = 300$	GDG Expert Opinion
Abnormal results which are indeterminate	20%	Beta	$\alpha = 200, \beta = 800$	
Specificity	0.997	Beta	$\alpha = 45822, \beta = 138$	Clinical Review- Halpern 2010 ¹⁸³
Normal results which are indeterminate	90%	Beta	$\alpha = 900, \beta = 100$	GDG Expert Opinion
Abnormal results which are indeterminate	50%	Beta	$\alpha = 500, \beta = 500$	
Clinical events (Positive Cases—Patients with CSI)				
After no imaging				GDG Expert Opinion
Probability clinician chooses immediate	5%	Uniform	Min =4.5% ,	

Parameter description	Deterministic estimate	Probability distribution	Distribution parameters	Source
discharge			Max =5.5%	
Probability clinician chooses observation then discharge	95%	Uniform	Min = 85.5%, Max =100%	
After no imaging & discharge				
Probability deteriorate	95.0%	Uniform	Min = 85.5%, Max =100%	
Probability no deterioration	5.0%	Uniform	Min = 4.5%, Max =5.5%	
After no imaging & observe				
Probability deteriorate	20.0%	Uniform	Min = 18%, Max =22%	
Probability no deterioration	80.0%	Uniform	Min = 72%, Max =88%	
After abnormal initial CT result				
Probability clinician chooses MRI again	70%	Uniform	Min = 63%, Max =77%	
Probability clinician chooses to treat	30%	Uniform	Min = 27%, Max =33%	
After indeterminate initial CT result				
Probability clinician chooses MRI again	60%	Uniform	Min = 54%, Max =66%	
Probability clinician chooses flexion/extension x-ray	40%	Uniform	Min = 36%, Max =44%	
After indeterminate CT and abnormal MRI				
Probability clinician chooses flexion/extension x-ray	10%	Uniform	Min = 9%, Max =11%	
Probability clinician chooses to treat	90%	Uniform	Min = 81%, Max =99%	
After indeterminate CT and indeterminate MRI				

Parameter description	Deterministic estimate	Probability distribution	Distribution parameters	Source
Probability clinician chooses flexion/extension x-ray	50%	Uniform	Min = 45%, Max =55%	
Probability clinician chooses to observe	50%	Uniform	Min = 45%, Max =55%	
After indeterminate CT and normal MRI				
Probability clinician chooses flexion/extension x-ray	20%	Uniform	Min = 18%, Max =22%	
Probability clinician chooses to discharge	70%	Uniform	Min = 63%, Max =77%	
Probability clinician chooses to observe 1 week	10%	Uniform	Min = 9%, Max =11%	
After indeterminate CT and abnormal flexion-extension				
Probability clinician chooses to treat	5%	Uniform	Min = 4.5%, Max =5.5%	
Probability clinician chooses MRI	95%	Uniform	Min = 85.5%, Max =100%	
After indeterminate CT and indeterminately flexion-extension				
Probability clinician chooses to observe and discharge	1%	Uniform	Min = 0.9%, Max =1.1%	
Probability clinician chooses MRI	99%	Uniform	Min =89.1%, Max =100%	
After indeterminate CT and normal flexion-extension				
Probability clinician chooses to discharge	40%	Uniform	Min =36% , Max =44%	
Probability clinician chooses MRI	60%	Uniform	Min = 54%, Max =66%	
After first x-ray is abnormal				
Probability clinician chooses CT	95%	Uniform	Min =85.5%, Max =100%	

Parameter description	Deterministic estimate	Probability distribution	Distribution parameters	Source	
Probability clinician chooses MRI	5%	Uniform	Min = 4.5%, Max =5.5%		
After first x-ray is indeterminate					
Probability clinician chooses CT	99%	Uniform	Min =89.1%, Max =100%		
Probability clinician chooses MRI	1%	Uniform	Min = 0.9%, Max =1.1%		
After first x-ray is normal					
Probability clinician chooses discharge	95%	Uniform	Min =85.5%, Max =100%		
Probability clinician chooses observe	5%	Uniform	Min = 4.5%, Max =5.5%		
Clinical events (Negative Cases—Patients without CSI)					
After no imaging					GDG Expert Opinion
Probability clinician chooses immediate discharge	95%	Uniform	Min =85.5%, Max =100%		
Probability clinician chooses observation then discharge	5%	Uniform	Min = 4.5%, Max =5.5%		
After abnormal initial CT result					
Probability clinician chooses MRI again	99%	Uniform	Min =89.1%, Max =100%		
Probability clinician chooses to treat	1%	Uniform	Min = 0.9%, Max =1.1%		
After indeterminate initial CT result					
Probability clinician chooses MRI again	90%	Uniform	Min =89.1%, Max =100%		
Probability clinician chooses flexion/extension x-ray	10%	Uniform	Min =9% , Max =11%		
After indeterminate CT and abnormal MRI					
Probability clinician chooses flexion/extension x-ray	10%	Uniform	Min = 9%, Max =11%		

Parameter description	Deterministic estimate	Probability distribution	Distribution parameters	Source
Probability clinician chooses to treat	90%	Uniform	Min = 81%, Max =99%	
After indeterminate CT and indeterminate MRI				
Probability clinician chooses flexion/extension x-ray	35%	Uniform	Min =31.5%, Max =38.5%	
Probability clinician chooses to observe	65%	Uniform	Min =58.5%, Max =71.5%	
After indeterminate CT and normal MRI				
Probability clinician chooses flexion/extension x-ray	1%	Uniform	Min = 0.9%, Max =1.1%	
Probability clinician chooses to discharge	98%	Uniform	Min =88.2%, Max =100%	
Probability clinician chooses to observe 1 week ⁵²⁰ k	1%	Uniform	Min =0.9% , Max =1.1%	
After indeterminate CT and abnormal flexion-extension				
Probability clinician chooses to treat	10%	Uniform	Min = 9%, Max =11%	
Probability clinician chooses MRI	90%	Uniform	Min = 81%, Max =99%	
After indeterminate CT and indeterminate flexion-extension				
Probability clinician chooses to observe and discharge	5%	Uniform	Min = 4.5%, Max =5.5%	
Probability clinician chooses MRI	95%	Uniform	Min =85.5%, Max =100%	
After indeterminate CT and normal flexion-extension				
Probability clinician chooses to discharge	50%	Uniform	Min = 45%, Max =55%	
Probability clinician	50%	Uniform	Min = 45%,	

Parameter description	Deterministic estimate	Probability distribution	Distribution parameters	Source
chooses MRI			Max =55%	
After first x-ray is abnormal				
Probability clinician chooses CT	95%	Uniform	Min = 85%, Max =100%	
Probability clinician chooses MRI	5%	Uniform	Min = 4.5%, Max =5.5%	
After first x-ray is indeterminate				
Probability clinician chooses CT	99%	Uniform	Min =89.1% Max =100%	
Probability clinician chooses MRI	1%	Uniform	Min = 0.9%, Max =1.1%	
After first x-ray is normal				
Probability clinician chooses discharge	95%	Uniform	Min = 85%, Max =100%	
Probability clinician chooses observe	5%	Uniform	Min = 4.5%, Max =5.5%	
Clinical events (Treatment Clinical Judgements)				
Of all patients needing treatment,				GDG Expert Opinion
percentage who have Cervical Spinal Cord Injury (CSCI)	10%	Uniform	Min =9% , Max =11%	
percentage who do not have CSCI	90%	Uniform	Min = 81%, Max =99%	
Of all patients with CSCI,				
percentage who have complete CSCI ?	50%	Uniform	Min = 45%, Max =55%	
percentage who have partial CSCI	50%	Uniform	Min = 45%, Max =55%	
Of the patients with complete CSCI,				
percentage who have compression	90%	Uniform	Min = 81%, Max =99%	
percentage who do not have compression	10%	Uniform	Min = 9%, Max =11%	

Parameter description	Deterministic estimate	Probability distribution	Distribution parameters	Source
Of the patients with complete CSCI and compression,				
Percentage who have surgical treatment	90%	Uniform	Min = 81%, Max =99%	
Percentage who have non-surgical treatment	10%	Uniform	Min = 9%, Max =11%	
Of the patients with complete CSCI and no compression,				
percentage who are stable	50%	Uniform	Min = 45%, Max =55%	
percentage who are unstable	50%	Uniform	Min = 45%, Max =55%	
Of the patients with partial CSCI,				
percentage who have compression	50%	Uniform	Min = 45%, Max =55%	
percentage who do not have compression	50%	Uniform	Min = 45%, Max =55%	
Of patients with partial CSCI and compression,				
percentage who have surgical procedure	90%	Uniform	Min = 81%, Max =99%	
percentage who have non-surgical procedure	10%	Uniform	Min = 9%, Max =11%	
Of patients with partial CSCI and no compression,				
percentage who are stable	75%	Uniform	Min = 68%, Max =83%	
percentage who are unstable	25%	Uniform	Min = 23%, Max =28%	
Of patients with no CSCI,				
percentage who are stable?	90.0%	Uniform	Min = 81%, Max =99%	
percentage who are	10.00%	Uniform	Min = 9%,	

Parameter description	Deterministic estimate	Probability distribution	Distribution parameters	Source
unstable			Max =11%	

CSI = Cervical Spine Injury; CT = Computed Tomography; FE = Flexion Extension X-ray; HI = Head Injury; MRI = Magnetic Resonance Imaging; NEXUS = National Emergency X-Radiography Utilisation Study;

M.1.3.2 Resource use and cost

NHS reference costs 2011-2012¹⁰⁵ were used to identify cost estimates for diagnostic imaging and treatment for CSI used in the base case analysis. Details are reported below.

Diagnostic Imaging

Diagnostic imaging costs are routinely incorporated in inpatient HRG codes. However, Multiple Trauma HRG codes and Emergency Medicine HRG codes relevant to our population were considered inadequate for our purposes as these cost codes were minimally influenced by differences in diagnostic imaging interventions and were largely derived from surgical and medical procedures.

As a result, unbundled costs for diagnostic imaging were used to allow for clear cost differentiations. The GDG judged this to be appropriate especially because a significant proportion the population could have diagnostic imaging without patient admittance into hospital.

The cost of CT and MRI diagnostic imaging techniques were calculated by taking a weighted average of total activities and cost in outpatient, direct access and other settings. The GDG judged that a CT or MRI scan requires a scan of two areas considering patients will need their head and cervical spine areas examined (NHS Reference Cost Codes 2011-2012 RA11Z; RA04Z). The cost of a CT was £104 and the cost of a MRI was £182.

The cost of diagnostic imaging with x-ray (Plain Film Radiograph) was £30.3 and was derived from NHS Reference Costs 2011-2012 cost code DAPF. The GDG judged a flexion extension investigation would require 2 plain film X-rays with a total cost of £61.

Cost of treatment

Costs for treatment were derived from NHS Reference Costs 2011-2012, HC codes (Spinal Surgery and Disorders Chapter). There is a certain degree of double counting as each NHS reference cost code (HC01-HC06) is applied to more than one treatment cost calculation. This was deemed appropriate as the GDG judged procedures within NHS reference codes HC01-HC06 were applicable to multiple treatment categories.

A patient who is discharged upon clinical impressions and diagnostic imaging results showing no abnormality does not require treatment and accrues a cost of £0. The GDG judged the cost of discharge to be similar across all patients who remain alive. Thus, the cost of discharge was not considered necessary for our incremental analysis.

Some patients with CSI and in need of treatment are inappropriately discharged and experience deterioration. The GDG assumed that a patient who deteriorates will again present to the hospital, undergo diagnostic imaging, and then receive treatment. Assuming a worst-case scenario where the diagnostic investigation requires all types of diagnostic imaging (a CT, MRI, FE X-ray and an X-ray) and the treatment requires a surgical and/or non-surgical procedure, the maximum cost for deterioration is £7,214. Those patients who do not experience deterioration did not accrue any additional costs.

In particular, where a surgical procedure was deemed appropriate, the cost was £7,117, the weighted average of NHS cost codes HC01-HC04. The cost of a non-surgical procedure was £4,459

and was the weighted average of NHS cost codes HC05 and HC06. Using the NHS Reference cost code HC21B weighted across settings, the cost of no procedure with SCI was £17,252 for an average length of stay of 42 days. The cost of a surgical or non-surgical procedure was £6,837 calculated as the weighted average of NHS reference cost codes HC01-HC06. According to the NHS reference cost code HC21C weighted across settings, the cost of no procedure for patients without CSI was £4,979 for an average length of stay of 5.6 days.

M.1.3.3 Diagnostic mark-up

For each strategy, the diagnostic mark-up provides the total cost and number of diagnostic images undertaken per diagnostic technique (X-ray, CT, MRI, and FE X-ray). The total number of diagnostic imagings was the sum of diagnostic imagings undertaken at initial and at further imaging stages.

Initial Imaging

The number of patients who received initial imaging (CT, X-ray, or no imaging) was different according to strategy. In blanket Strategies 1-3, the entire cohort received initial CT / X-ray imaging or no imaging. In Strategies 4-7, the number of patients who received initial imaging was determined by the sensitivity and specificity of prediction rules. These strategies did not indicate diagnostic imaging (CT/X-ray) for all patients. For Example, in Strategy 4 (Canadian C-spine for X-ray), the prediction rule did not recommend an X-ray for 58% of patients without CSI. The GDG assumed that these patients might still be imaged. To determine the proportion of patients who would receive the remaining diagnostic imaging alternatives, the GDG estimated half of all remaining patients would receive no imaging and the other half of all remaining patients would receive the alternative diagnostic imaging technique (CT/X-ray). In Strategy 4, the prediction ruled did not recommend an X-ray for 58% of patients without CSI and of these 58%, 29% received CT and 29% received no Imaging Details on the GDG estimated apportioning of patients to all initial imaging alternatives for each strategy can be found in Figure 74.

Figure 74

Probability of having a given initial image strategy	Initial clinical decision (for those without injury)			Initial clinical decision (for those with injury)		
	No imaging	CT first	X ray first	No imaging	CT first	X ray first
Strategy 1: No imaging	100%			100%		
Strategy 2: CT all		100%			100%	
Strategy 3: x ray all			100%			100%
Strategy 4: Canadian C spine for Xray	29%	29%	43%	0%	0%	100%
Strategy 5: Canadian C Spine for CT	49.7%	0.6%	49.7%	0%	100%	0%
Strategy 6: NEXUS for Xray	32%	32%	37%	4.65%	4.65%	90.70%
Strategy 7: NEXUS for CT	38%	24%	38%	5%	90%	5%

Further Imaging

The number of further diagnostic imaging performed was determined by the results from the initial diagnostic imaging technique. Results from a diagnostic imaging technique were categorised as normal (diagnostic imaging and clinical impression finds no abnormality), indeterminate (diagnostic imaging and clinical impression finds presence or absence of injury uncertain) or abnormal (abnormality is clear from diagnostic imaging and clinical impression). The number of normal and abnormal results were derived by from the sensitivity (abnormal) and specificity (normal) of diagnostic clearance strategies found in published literature (Halpern 2010)¹⁸³. However, there is no data available to inform the number of indeterminate results from diagnostic imaging. The GDG considered that a certain proportion normal and abnormal results would be considered

‘indeterminate’ and that these proportions would differ for a population with CSI and a population without CSI.

Patients who did not receive initial imaging and patients with normal initial imaging results would not be given any further imaging or treatment.

Patients with an indeterminate or abnormal initial imaging result could receive further diagnostic imaging. The type and number of further diagnostic imaging (maximum number = 3) was determined by clinical judgement.

Therefore, the cost of diagnostic imaging was the product of the total number of diagnostic imagings undertaken per diagnostic technique and the unit cost of each diagnostic technique.

Where there is indication of abnormality from diagnostic imaging results and clinical impressions, further management is required.

M.1.3.4 Treatment component

The treatment component uses GDG clinical judgments to subcategorise patients requiring treatment according to injury characteristics so as to identify the type of treatment required and apply the correct weighting to costs. These GDG judgements are detailed in section M.1.2.1. The cost of treatment was calculated as the sum of the cost of each category of treatment. The cost of each category of treatment was the product of the number of treatments and the unit cost of treatment.

M.1.3.5 Computations

The analysis was undertaken using Microsoft Excel 2010. The model is a cohort decision-tree. The PSA was conducted using 7500 simulations (see M.1.4). Each strategy is made up of a diagnostic and treatment component. The prevalence of CSI combined with the performance of prediction rules and the performance of diagnostic imaging techniques determined the number of patients correctly provided treatment (TP), incorrectly provided treatment (FP), correctly left untreated (TN), and incorrectly left untreated (FN).

For computations informing estimation of cost effectiveness please refer to sections M.1.5 and M.1.6.

M.1.4 Sensitivity analyses

A number of deterministic sensitivity analysis were undertaken to investigate uncertain individual input parameters. The GDG wished to identify whether varying that individual input value would have an effect on results. The following inputs were investigated using DSA.

1. Cost of no procedure for patients with and without CSI: there was uncertainty around the cost differentiation for no procedure in patients with (£17,252) and without CSI (£4,979). Hence, the cost for no procedure was made equal for both patients with and without CSI at £ 5,141. This was the weighted cost of HC21B and HC21C across NHS settings for a 10 day length of stay.
2. Litigation cost associated with a FN: given the uncertainty around the average litigation cost for a missed CSI, the litigation cost was varied from £0 to £1,000,000.
3. Initial imaging decisions: there was uncertainty over the base case percentage of patients without CSI who would receive initial imaging (CT/X-ray) or no imaging according to clinical decision rules in Strategies 1-7. Primary analysis percentages were calculated based on the sensitivity and specificity of clinical decision rules and GDG estimates. The uncertainty was attributed to the low quality of specificity data for prediction rules in Duane¹¹⁵ and Griffith¹⁷⁴. This was explored by calculating percentages using different GDG estimates as indicated in Figure 75 (see percentages highlighted by red rectangle).

4. QALY pay-offs: in the absence of applicable Quality of Life information for this population, an extremely conservative QALY pay-off was assigned to each outcome (TP, FN, TN, and FP) in a hypothetical scenario. The QALY payoffs assigned (TP = 1.5 QALYs, TN & FP = 2 QALYs, and FN = 1 QALY) served to incorporate the smaller pay-off associated with a FN in comparison to patients without CSI (TN) and patients who received treatment (TP and FP). Net monetary benefit was subsequently calculated using Equation 1, where 'Outcome' was equal the number of QALYs and D was equal to the threshold of £20,000 per QALY gained.
5. Prevalence of patients over the age of 16 with CSI: given the absence of information on the prevalence of CSI, the prevalence was varied between 0.5% (base case) to 5% in increments of 0.5%.
6. Clinical decision for further imaging of indeterminate and negative initial imaging results: Given the absence of clinical and economic evidence on the clinical and cost-effectiveness identified for Strategies 1-7 and their application to further imaging scenarios, the following scenarios were compared
 - a. further imaging on indeterminate cases only (base case analysis)
 - b. no further imaging on negative or indeterminate cases
 - c. further imaging on all negative and indeterminate cases

In scenarios a. to c., positive initial imaging results receive further imaging.

Figure 75 GDG estimation of initial imaging probabilities for those without injury (Strategy 4-7)

Probability of having a given initial image strategy	Initial clinical decision (for those without injury)			Initial clinical decision (for those with injury)		
	No imaging	CT first	X ray first	No imaging	CT first	X ray first
7						
Strategy 1: No imaging	100%			100%		
Strategy 2: CT all		100%			100%	
Strategy 3: x ray all			100%			100%
Strategy 4: Canadian C spine for Xray	54%	3%	43%	0%	0%	100%
Strategy 5: Canadian C Spine for CT	54%	46%	0%	0%	100%	0%
Strategy 6: NEXUS for Xray	60%	3%	37%	4.65%	4.65%	90.70%
Strategy 7: NEXUS for CT	22%	40%	38%	5%	90%	5%

Probabilistic Sensitivity Analysis

For the probabilistic analysis, inputs were parameterised with distributions as described in

Table 70 below. To parameterise the reference costs probabilistically, three distributions (gamma, lognormal and normal) were fitted and the best-fit distribution was chosen. Each distribution was fit using the standard deviation of the trust cost (calculated using the reported mean and interquartile range), and where appropriate, the distribution's alpha and beta values. The distribution that provided the interquartile range closest in value to the interquartile range reported by the NHS reference cost was considered the best fit distribution. Estimates from the best-fit distribution were applied to the formulas listed below to calculate the standard error of the mean NHS cost and subsequently, the probabilistic value was drawn.

Table 70: Description of the type and properties of distributions used in the probabilistic sensitivity analysis

Parameter	Probability distribution	Properties of distribution
Clinical Judgements	Uniform	Uniform distribution fitted between the minimum and maximum range allows an equal chance of any value within this range being selected in any simulated run of the probabilistic analysis. The minimum and maximum range for clinical judgements was $\pm 10\%$ of the base case value with a maximum of 100%.
Performance of prediction rules (sensitivity and specificity)	Beta	Beta distribution fitted between 0 and 1. As the sample size and the number of events were specified alpha and beta values were calculated as follows: Alpha: (number of patients with CSI/without CSI) Beta=(Number of patients)-(number of patients with CSI/without CSI)
Performance of diagnostic imaging techniques (sensitivity and specificity)	Beta	Beta distribution fitted between 0 and 1. Derived from mean of a domain or total quality of life score and its standard error, using the method of moments. Alpha and Beta values were calculated as follows: Alpha = $mean^2 * (1 - (mean/SE^2) - mean)$ Beta = $Alpha * ((1 - mean)/mean)$
Number of indeterminate results after imaging technique	Beta	Beta distribution fitted between 0 and 1. The sample size and the number of events were specified by the cohort size and GDG estimations. Thus, alpha and beta values were calculated as follows: Alpha = (number of patients with indeterminate result) Beta = (Number of patients)-(number of patients with indeterminate results)
NHS Reference Costs (diagnostic and treatment)	Gamma	Gamma distribution bounded at 0 and positively skewed. Derived from mean and its standard error. Alpha and Beta values were calculated as follows: Alpha = $(mean/SE)^2$ Beta = $SE^2/Mean$
NHS Reference Costs (diagnostic and treatment)	Lognormal	Where appropriate, the lognormal distribution may provide a better fit than the gamma distribution for costs. The natural log of the mean was calculated as follows: Natural log of the mean = $[Ln(mean) - (LnSE)^2]/2$ Where the natural log of the standard error (LnSE) was calculated by: $\sqrt{\ln \frac{SE^2 + mean^2}{mean^2}}$
NHS Reference Costs (diagnostic and treatment)	Normal	Where appropriate, the normal distribution may provide a better first than the gamma and lognormal distribution for costs. The mean and standard error was calculated as follows: Mean = $\frac{sum\ of\ all\ values}{number\ of\ values}$ Standard Error = $\frac{standard\ deviation}{\sqrt{number\ of\ values}}$

With all distributions drawn, a simulation was run for each strategy independently and key results of each simulation were copied and stored. To compare the results generated for a single iteration, the starting seed for each random number selected for the probabilistic analysis was reset to original with each rerun of the probabilistic simulation. This assured, for example, the PSA referred to the same prevalence for all seven strategies in any given iteration and ensured the results for each iteration across the strategies were comparable.

M.1.5 Estimation of cost effectiveness

The widely used cost-effectiveness metric is the incremental cost-effectiveness ratio (ICER). This is calculated by dividing the difference in costs associated with two alternatives by the difference in QALYs. The decision rule then applied is that if the ICER falls below a given cost per QALY threshold the result is considered to be cost effective. If both costs are lower and QALYs are higher the option is said to dominate and an ICER is not calculated.

$$ICER = \frac{Costs(B) - Costs(A)}{QALYs(B) - QALYs(A)}$$

Where: $Costs/QALYs(X)$ = total costs/QALYs for option X

- Cost-effective if:
ICER < Threshold

When there are more than two comparators, as in this analysis, options must be ranked in order of increasing cost then options ruled out by dominance or extended dominance before calculating ICERs excluding these options. An option is said to be dominated, and ruled out, if another intervention is less costly and more effective. An option is said to be extendedly dominated if a combination of two other options would prove to be less costly and more effective.

It is also possible, for a particular cost-effectiveness threshold, to re-express cost-effectiveness results in term of net monetary benefit (NMB). This is calculated by multiplying the total QALYs for a comparator by the threshold cost per QALY value (for example, £20,000) and then subtracting the total costs (formula below). The decision rule then applied is that the comparator with the highest NMB is the most cost-effective option at the specified threshold. That is the option that provides the highest number of QALYs at an acceptable cost.

$$NMB(X) = (QALYs(X) \times \lambda) - Costs(X)$$

Where: NMB= Net Monetary Benefit; $Costs/QALYs(X)$ = total costs/QALYs for option X; λ = threshold

- Cost-effective if:
highest net monetary
benefit

Both methods of determining cost effectiveness will identify exactly the same optimal strategy. For ease of computation, adaptations of the NMB formula are used in this analysis to identify the optimal strategy.

In the case of cost-effectiveness analysis where cost per QALY is not estimated, and rather an alternative outcome (i.e. cost per false negative avoided) is used, there is not a specific cost per effect threshold employed to assess cost effectiveness. However, these outcomes can still be used to identify dominated and extendedly dominated options. Further, an assumed cost and/or QALY weight can be attached to such outcomes to enable net monetary benefit calculations, as described in the below equations:

$$NMB(X) = (Outcome(X) \times QALY_Weight \times \lambda) - Costs(X)$$

Where: NMB = Net Monetary benefit; $Outcome(x)$ = the diagnostic outcome for which the QALY weight applies; λ = threshold of £20,000

- Cost-effective if:
highest net monetary
benefit

$$NMB(X) = (FN(X) \times -LitigationCost) - Costs(X)$$

Where: NMB = Net Monetary Benefit; FN = False negatives identified; litigation costs represents the negative cost associated with the false negative and Costs (x) is the total cost of the strategy

- Cost-effective if: highest net monetary benefit

M.1.6 Interpreting results

NICE's report 'Social value judgements: principles for the development of NICE guidance' sets out the principles that GDGs should consider when judging whether an intervention offers good value for money. In general, an intervention was considered to be cost effective if either of the following criteria applied (given that the estimate was considered plausible):

- The intervention dominated other relevant strategies (that is, it was both less costly in terms of resource use and more clinically effective compared with all the other relevant alternative strategies), or
- The intervention costs less than £20,000 per quality-adjusted life-year (QALY) gained compared with the next best strategy.

In the absence of data to inform a lifetime costs and QALYs associated with the strategies (i.e. data on longterm survival and medical events), the model evaluates the diagnostic strategies using three types of analyses, each referencing a different key outcome. These are:

- a) A cost effectiveness analysis which compares the cost per false negative avoided in a given strategy.
- b) A cost minimisation analysis whereby the litigation costs accrued are evaluated against the cost of the strategy, with results expressed in net monetary benefit.
- c) A simplistic cost utility sensitivity analysis which compares the net monetary benefit associated with each strategy given minimal QALY gains per correct diagnosis and minimal QALY loss per incorrect diagnosis.

As we have several strategies of comparison, we use Net Monetary Benefit to rank the strategies on the basis of their relative cost-effectiveness and identify dominated or extendly dominated options.

A note on Net Monetary Benefit Analysis using litigation costs.

Using information on total cost and outcome and assuming the litigation cost penalty associated with a FN was -£200,000, net monetary benefit was calculated. This statistic was calculated as the number of False Negatives multiplied by the cost penalty (a litigation penalty of -£200,000) minus the total cost of strategy (Equation 1). Because the cost penalty of a false negative was greater than the total cost of strategy, the net monetary benefit figure is negative. Net Monetary Benefit Results were ranked from 1 to 7 across all strategies with Rank 1 representing the largest Net Monetary Benefit and Rank 7 as the least Net Monetary Benefit.

To minimise costs, the GDG would consider the strategy with the highest net monetary benefit. In the sensitivity analysis where QALYs were assigned to each outcome, the monetary value associated with each QALY gained was £20,000. The GDG would consider the optimal or dominant strategy from this analysis when making recommendations.

M.1.7 Model validation

The model was developed in consultation with the GDG; model structure, inputs and results were presented to and discussed with the GDG for clinical validation and interpretation.

The model was systematically checked by the health economist undertaking the analysis; this included inputting null and extreme values and checking that results were plausible given inputs. The model was peer reviewed externally and by a second experienced health economist from the NCGC; this included systematic checking of the model calculations.

M.2 Results

M.2.1 Base Case Results

Each strategy is composed of diagnostic imaging, outcomes, and treatments. Thus, **Table 71 - Table 74** qualify the differences in base case deterministic diagnostic imaging, outcomes and treatments across strategies. Understanding these differences will help the interpretation of base case probabilistic results in **Table 75** and **Table 76**.

Table 71 presents a breakdown of the total number of diagnostic imaging according to the strategy. The table also shows the percentage of the cohort who receives each type of diagnostic imaging.

Table 72 presents a breakdown of the performance of each strategy. Outcomes are considered as the percentage of TP, FN, TN and FP. In each strategy, majority of patients without CSI are correctly diagnosed as TN and very few are incorrectly diagnosed as FP. A significant proportion of patients with CSI are incorrectly diagnosed as FN. The strategy with the smallest (28%) and largest (100%) percentage of FNs are Strategy 2/Strategy 5 (CT for all/Canadian C-spine for CT) and Strategy 1 (No Imaging) respectively.

As **Table 73** illustrates, very few patients are treated across strategies. At the extremes, no one is treated in Strategy 1 (No Imaging) and 7 patients out of 1,000 are treated in Strategy 5 (Canadian C-spine for CT). Of those who receive treatment, the majority do not receive a procedure but are instead observed in hospitals (those who are given no procedure with or without CSI).

Table 74 presents the total cost of each strategy. Strategy 3 (X-ray all) is most costly while Strategy 1 (No Imaging) is least costly. The cost of each strategy is most influenced by the cost of diagnostic imaging and the cost of observation. Because of the small number of patients treated across strategies, the cost of treatment assumes a relatively small proportion of the total cost of strategy. By considering both the number of diagnostic imaging results as well as the differential cost across types of diagnostic imaging, the total costs of each strategy is calculated. The strategies with the highest (£289,558) and lowest (£0) diagnostic imaging costs are Strategy 2 (CT all) and Strategy 1 (No Imaging) respectively.

The Net Monetary Benefit analysis (**Table 75**) provides the base case deterministic results and illustrates that Strategy 5 (Canadian C-spine for CT) is the optimal strategy (highest net monetary benefit) while Strategy 1 (No Imaging) was the least optimal (lowest net monetary benefit).

In addition, **Table 76** presents the results of the cost effectiveness analysis where incremental costs and false negatives avoided were calculated using Strategy 1 (No Imaging) as the base comparator. The lowest (£88,458) and highest (£271,310) costs per false negative avoided were associated with Strategy 5 (Canadian C-Spine for CT) and Strategy 3 (X-ray on all) respectively.

M.2.2 Sensitivity Analysis Results

Strategy 5 remained the optimal strategy in the probabilistic analysis and it was the most cost-effective strategy in 93% of the simulations. Strategy 5 was optimal despite variation to individual inputs - equal costs for no procedure with or without CSI (Table 76); GDG estimated initial imaging decisions (Table 78); QALY pay-offs (Table 79); prevalence of CSI between 0.5%-5% (Figure 76) in the deterministic sensitivity analysis. Assuming that Strategy 1 (No Imaging) is not an ethical option, Strategy 5 was also the optimal strategy when the litigation costs associated with a missed FN was between £0 and £1,000,000 (Table 77). Strategy 5 was also the optimal strategy when the clinical decision was to not further image normal and indeterminate results or to only further image indeterminate results. When the clinical decision was to further image both normal and indeterminate results, Strategy 2 (CT all) became optimal.

In the sensitivity analysis that assigned a minimal QALY advantage per correct diagnosis it was found that no imaging ranked optimal. If no imaging was not considered an acceptable or ethical strategy, then strategy 5 would be the most optimal strategy.

M.3 Interpreting results

M.3.1 Summary of results

The probabilistic analysis identified Strategy 5 (Canadian C-spine for CT) to be dominant at a threshold of £200,000 for each FP outcome meaning that Strategy 5 was less costly and avoided more FPs than all the other strategies. Strategy 5 also had the lowest cost per False Negative avoided. This conclusion was robust to variations in the prevalence of CSI (0.5%-5%), cost of no procedure with or without CSI and GDG estimated initial imaging decisions and when the decision to not further image or to further image only indeterminate results. When the clinical decision was to further image both normal and indeterminate results, the optimal strategy changed to Strategy 2 (CT all).

The results were sensitive to the cost of litigation associated with a false negative, with the optimal ranking switching from no imaging to strategy 5 when litigation costs rose from £75,000 to £100,000. No imaging was also seen as an optimal strategy if only a minimal QALY advantage was associated with achieving a true positive in comparison to other diagnostic outcomes. Strategy 5 was the next optimal strategy in this analysis.

M.3.2 Limitations and interpretation

We acknowledge the CEA does not fully account or quantify all of the trade offs involved with the diagnostic decision question, as no weighting or penalty was given to other diagnostic outcomes such as false positives (although unnecessary treatment cost is taken into account). However, the estimated negative monetary payoff of £200,000 associated with each FN outcome implicitly took into account the adverse effects of radiation and the potential of deterioration after treatment or no treatment. Nonetheless, it is necessary to interpret this analysis with caution as it has some potentially serious limitations.

That the 'No Imaging' strategy may be optimal in scenarios where there are limited negative consequences associated with a false negative finding and where there is little to gain with positive findings (i.e. correct onward treatment and QALY gain) is a reflection of the low prevalence of CSI within a head injury population and the trade off involved with the decision problem. A low prevalence of a condition will inevitably lower the negative predictive values of a diagnostic intervention (in comparison to if the diagnostic intervention was placed in a high prevalence setting), in turn favour a non imaging strategy, especially when the downstream consequences of a correct

or incorrect diagnostic are marginal in relation to each other. In this model, an extremely conservative estimate of the gains of diagnostics was specified.

The GDG felt that despite the limitations, the analysis is sufficiently robust for purposes of decision-making as it explicitly shows and attempts to quantify the parameters, assumptions and structure underpinning the decision. To interpret the results, the GDG acknowledged that the consequences of each diagnostic outcome was uncertain, and took the view that in practice a non imaging strategy was not viable to recommend.

Assuming that Strategy 1 (No Imaging) was a theoretical strategy not plausible (ethical) in practice, the CT according to Canadian C-spine was optimal when the false negative litigation costs varied from £0 - £1,000,000. The conclusion that CT using the Canadian C-spine prediction rule remained gave the greatest net monetary benefit in the scenario of minimal QALY gain associated with each true positive and minimal QALY loss with each false negative under the assumption that No Imaging was not appropriate in practice.

With the view that a non imaging strategy could not be recommended, the sensitivity analysis whereby an extremely conservative scenario was explored in terms of pay-off indicates that despite the limitations of the CEA, the conclusions formed by the analysis appear robust. In addition, that Strategy 5 (CT according to Canadian C-spine) remained robust when the threshold value associated with a FN was varied from £0 to £1,000,000 (assuming the No Imaging strategy was not appropriate in practice) also supports the conclusions made in this analysis. In line with the NICE reference case, all parameters subject to uncertainty (i.e. unit costs, sensitivities and specificities of the prediction rules and clinician estimates) were parameterised probabilistically and probabilistic sensitivity analysis performed.

M.3.3 Generalisability to other populations

A separate subgroup analysis was not conducted for a paediatric population. The results of this analysis are not applicable for children under the age of 16 with HI and suspected CSI. The GDG felt this economic analysis could not be extrapolated to the paediatric population as this is clinically quite different from the adult population. No evidence was identified for paediatrics and so, it was not possible to determine the appropriateness of model inputs for the paediatric population (in particular, the prevalence of CSI & the clinical judgements for further imaging and treatment used in the analysis for adults). For this population, the trade off between the accuracy of diagnosis and the radiation risk associated with a CT scan (equivalent to 2 years background radiation) requires particular discussion. The GDG would consider that a plain film X-ray has lower levels of radiation than a CT scan when writing recommendations for children.

M.3.4 Comparisons with published studies

No studies that looked at the use of prediction rules for the selection of HI patients with suspected CSI for diagnostic imaging were identified. One study by Pandor et al 2011,³⁷⁹ which investigated the use of prediction rules for the management of patients with minor HI found that in comparison to 9 other strategies, the Canadian CT Head Rule (CCHR) medium and high-risk prediction rule was the most cost-effective. Given this conclusion, the GDG considered that the CCHR could be used for a patient with HI and suspected CSI to rule out HI. Then, according to the conclusions from this analysis, Canadian CT Spine rule could be used for the same patient to rule out suspected CSI.

M.3.5 Conclusion

For patients with HI and suspected CSI, the Canadian C-spine decision rule is cost-effective for selecting patients for diagnostic imaging.

M.3.6 Implications for future research

The time horizon of this analysis only extended to the end of treatment. Considering this short time horizon and exclusion of quality of life health outcomes in this analysis, future research could explore the costs and health outcomes for a lifetime horizon. Results from this analysis were not extrapolated to the patient subgroup under the age of 16 because of a dearth of available information. Should clinical studies that look at the accuracy of prediction rules for children be available in the future, this analysis can be modified to provide information on the cost-effectiveness of C-spine injury clearance strategies for this subgroup.

M.4 Health economic appendix C: Tables and Figures

Base Case Results

Table 71 : Base Case Deterministic Analysis— Breakdown of Diagnostic Imaging for each Strategy

Base case Breakdown of Diagnostic Imaging for each strategy (prevalence 0.5%, cohort N = 1000)				
Strategy	# of Xrays (%)	# of CTs(%)	# of MRIs(%)	# of FE X-rays(%)
Strategy 1: No imaging	0 (0%)	0 (0%)	0 (0%)	0 (0%)
Strategy 2: CT all	0 (0%)	1000 (100%)	751 (75%)	812 (82%)
Strategy 3: X-ray all	1000 (100%)	792 (80%)	602 (61%)	643 (65%)
Strategy 4: Canadian C-spine for X-ray	433(43%)	626 (63%)	473 (48%)	508 (51%)
Strategy 5: Canadian C-spine for CT	495 (50%)	403 (40%)	307 (31%)	326 (33%)
Strategy 6: NEXUS for X-ray	371 (37%)	608 (61%)	459 (46%)	493 (50%)
Strategy 7: NEXUS for CT	379 (38%)	542 (54%)	410 (41%)	439 (44%)

Table 72: Base Case Deterministic Analysis – Performance of Strategies

Base case Results: Performance of Strategy (prevalence 0.5%, cohort N = 1000)				
Strategy	patients without CSI		patients with CSI	
	% True Negative	% False Positive	%False Negative	%True Positive
Strategy 1: No imaging	100.0%	0.0%	100%	0%
Strategy 2: CT all	99.7%	0.3%	28%	72%
Strategy 3: X-ray all	99.7%	0.3%	56%	44%
Strategy 4: Canadian C-spine for X-ray	99.8%	0.2%	56%	44%
Strategy 5: Canadian C-spine for CT	99.8%	0.1%	28%	72%
Strategy 6: NEXUS for X-ray	99.8%	0.2%	57%	43%
Strategy 7: NEXUS for CT	99.8%	0.2%	33%	67%

Table 73: Base Case Deterministic Analysis – Breakdown of Treatment Types

Base case Results: Breakdown of Types of Treatment (prevalence 0.5%, cohort N = 1000)						
Strategy	# of T* using surgical procedures only	# of T* using non surgical procedures only	# of T* where surgical or non surgical treatment is possible	#of T* with CSCI using no procedure ¹	# of T* without CSCI using no procedure ²	Total # Treated
Strategy 1: No imaging	-	-	-	-	-	0.0
Strategy 2: CT all	0.4	0.0	0.7	0.1	5.5	6.8
Strategy 3: X-ray all	0.3	0.0	0.5	0.1	3.9	4.8
Strategy 4: Canadian C-spine for X-ray	0.3	0.0	0.4	0.1	3.4	4.2
Strategy 5: Canadian C-spine for CT	0.3	0.0	0.5	0.1	4.0	4.9
Strategy 6: NEXUS for X-ray	0.3	0.0	0.4	0.1	3.3	4.1
Strategy 7: NEXUS for CT	0.3	0.0	0.5	0.1	4.1	5.1

T* = treatments

¹ = Number of patients with CSCI where diagnostic result indicates the need for treatment but injury characteristics indicate that no surgical or non surgical procedure is beneficial. Thus, no procedure is provided.

² = Number of patients without CSCI where diagnostic result indicates the need for treatment but injury characteristics indicate that no surgical or non surgical procedure is beneficial. Thus, no procedure is provided.

Table 74: Base Case Deterministic Analysis – Breakdown of Cost of Strategy

Base case Breakdown of Costs of Strategy (prevalence 0.5%, cohort N = 1000)				
Strategy	Cost of Treatment	Cost of Diagnostic Imaging	Cost of Observation	Total Cost of Strategy
Strategy 1: No imaging	£-	£-	£1,245	£1,245
Strategy 2: CT all	£37,930	£289,558	£1,264	£328,753
Strategy 3: X-ray all	£26,547	£260,916	£270,549	£558,012
Strategy 4: Canadian C-spine for X-ray	£23,496	£194,888	£117,019	£335,403
Strategy 5: Canadian C-spine for CT	£27,151	£132,283	£135,132	£294,566
Strategy 6: NEXUS for X-ray	£22,957	£187,678	£100,324	£310,960
Strategy 7: NEXUS for CT	£28,313	£168,905	£103,883	£301,102

Table 75: Base Case Deterministic Analysis Results with Probabilistic Analysis Rank

Base Case Deterministic Analysis CEA Results (prevalence 0.5%, cohort N = 1000)					
Strategy	Total Cost of Strategy	Total # of False Negatives Identified	Net Monetary Benefit	Rank	% ranked in PSA
Strategy 1: No imaging	£1,245	5.00	-£1,001,245	6	0%
Strategy 2: CT all	£328,753	1.42	-£612,099	2	7%
Strategy 3: X-ray all	£558,012	2.79	-£1,116,022	7	0%
Strategy 4: Canadian C-spine for X-ray	£335,403	2.79	-£893,413	5	0%
Strategy 5: Canadian C-spine for CT	£294,566	1.42	-£577,912	1	93%
Strategy 6: NEXUS for X-ray	£310,960	2.83	-£876,751	4	0%
Strategy 7: NEXUS for CT	£301,102	1.66	-£633,022	3	0%

Table 76: Base Case Probabilistic Analysis—Cost per False Negative Avoided

Base Case Probabilistic Results (prevalence 0.5%, cohort N = 1000)						
Strategy	Total Cost of Strategy	Incremental Cost of Strategy	Total # of FN Identified	Incremental # of FN Avoided	Net Benefit	Incremental Cost per False Negative Avoided
Strategy 1: No imaging (reference)	£1,214	-	5.00	-	-£1,000,947	-
Strategy 2: CT all	£328,041	£326,828	1.69	3.31	-£665,914	£98,760
Strategy 3: x ray all	£556,884	£555,670	2.95	2.05	-£1,146,996	£271,310
Strategy 4: Canadian C spine for Xray	£333,997	£332,783	2.95	2.05	-£924,109	£162,483
Strategy 5: Canadian C Spine for CT	£293,948	£292,734	1.69	3.31	-£631,821	£88,458
Strategy 6: NEXUS for Xray	£310,297	£309,083	2.99	2.01	-£907,807	£153,875
Strategy 7: NEXUS for CT	£300,537	£299,324	1.91	3.09	-£683,070	£96,994

Deterministic Sensitivity Analyses Results**Table 77: DSA with Cost for No Procedure with or without CSI Equal**

Deterministic Sensitivity Analysis on Costs for no procedure with and without CSI (prevalence 0.5%, cohort N = 1000, Equal cost for no procedure with and without CSI)				
Strategy	Total Cost of Strategy	Total # of False Negatives identified	Net Monetary Benefit	Rank
Strategy 1: No imaging	£1,285	5.0	-£1,001,285	6
Strategy 2: CT all	£327,933	1.4	-£611,278	2
Strategy 3: X-ray all	£566,211	2.8	-£1,124,221	7
Strategy 4: Canadian C-spine for X-ray	£338,677	2.8	-£896,687	5
Strategy 5: Canadian C-spine for CT	£298,346	1.4	-£581,692	1
Strategy 6: NEXUS for X-ray	£313,702	2.8	-£879,493	4
Strategy 7: NEXUS for CT	£303,838	1.7	-£635,759	3

Table 78 DSA with Litigation Costs (£0 - £1,000,000)

Deterministic Sensitivity Analysis on Litigation costs (£0-£1,000,000) ; Prevalence of CSI 0.5%; Cohort N =1000												
Litigation Cost												
Strategy	£0	£25,000	£50,000	£75,000	£100,000	£125,000	£150,000	£175,000	£200,000	£225,000	£250,000	£1,000,000
Strategy 1: No imaging	-£1,245	-£126,245	-£251,245	-£376,245	-£501,245	-£626,245	-£751,245	-£876,245	-£1,001,245	-£1,126,245	-£1,251,245	-£5,001,245
Strategy 2: CT all	-£328,753	-£364,171	-£399,589	-£435,008	-£470,426	-£505,844	-£541,262	-£576,680	-£612,099	-£647,517	-£682,935	-£1,745,482
Strategy 3: X-ray all	-£558,012	-£627,763	-£697,514	-£767,266	-£837,017	-£906,768	-£976,520	-£1,046,271	-£1,116,022	-£1,185,774	-£1,255,525	-£3,348,064
Strategy 4: Canadian C-spine for X-ray	-£335,403	-£405,154	-£474,906	-£544,657	-£614,408	-£684,160	-£753,911	-£823,662	-£893,413	-£963,165	-£1,032,916	-£3,125,455
Strategy 5: Canadian C-spine for CT	-£294,566	-£329,984	-£365,402	-£400,821	-£436,239	-£471,657	-£507,075	-£542,494	-£577,912	-£613,330	-£648,748	-£1,711,295
Strategy 6: NEXUS for X-ray	-£310,960	-£381,684	-£452,407	-£523,131	-£593,855	-£664,579	-£735,303	-£806,027	-£876,751	-£947,475	-£1,018,198	-£3,139,915
Strategy 7: NEXUS for CT	-£301,102	-£342,592	-£384,082	-£425,572	-£467,062	-£508,552	-£550,042	-£591,532	-£633,022	-£674,512	-£716,002	-£1,960,704

Table 79: DSA with GDG estimates for initial imaging decisions

Base case CEA Results (prevalence 0.5%, cohort N = 1000, prediction rule performance according to GDG estimates)				
Strategy	Total Cost of Strategy	Total # of False Negatives identified	Net Monetary Benefit	Rank
Strategy 1: No imaging	£1,245	5.0	-£1,001,245	6
Strategy 2: CT all	£328,753	1.4	-£612,099	2
Strategy 3: X-ray all	£558,012	2.8	-£1,116,022	7
Strategy 4: Canadian C-spine for X-ray	£335,403	2.8	-£893,413	5
Strategy 5: Canadian C-spine for CT	£294,566	1.4	-£577,912	1
Strategy 6: NEXUS for X-ray	£310,960	2.8	-£876,751	4
Strategy 7: NEXUS for CT	£301,102	1.7	-£633,022	3

Table 80 : DSA using QALY pay-offs (per cohort of 1000 patients)

	QALYs from TP ¹	QALYs from FN ²	QALYs from TN ³	QALYs from FP ⁴	Total QALY	NMB (£20K)	Rank
Strategy 1: No imaging	0.00	5.00	1990.00	0.00	1,995.00	£39,898,755	1
Strategy 2: CT all	5.37	1.42	1983.51	6.49	1,996.79	£39,607,080	4
Strategy 3: X-ray all	3.29	2.79	1983.42	5.17	1,994.67	£39,335,356	7
Strategy 4: Canadian C-spine for X-ray	3.29	2.79	1985.32	4.07	1,995.47	£39,574,054	6
Strategy 5: Canadian C-spine for CT	5.37	1.42	1986.69	2.61	1,996.09	£39,627,239	2
Strategy 6: NEXUS for X-ray	3.23	2.83	1985.53	3.95	1,995.54	£39,599,905	5
Strategy 7: NEXUS for CT	5.01	1.66	1985.95	3.52	1,996.13	£39,621,524	3

¹ QALYs from TP = # of TP multiplied by 1. 5 QALYs

² QALYs from FN = # of FN multiplied by 1 QALY

³ QALYs from TN = # of TN multiplied by 2 QALYs

⁴ QALYs from FP = # of FP multiplied by 2 QALYs

Figure 76 DSA with Prevalence of CSI ranging between 0.5%-5% (Cohort N =1000)

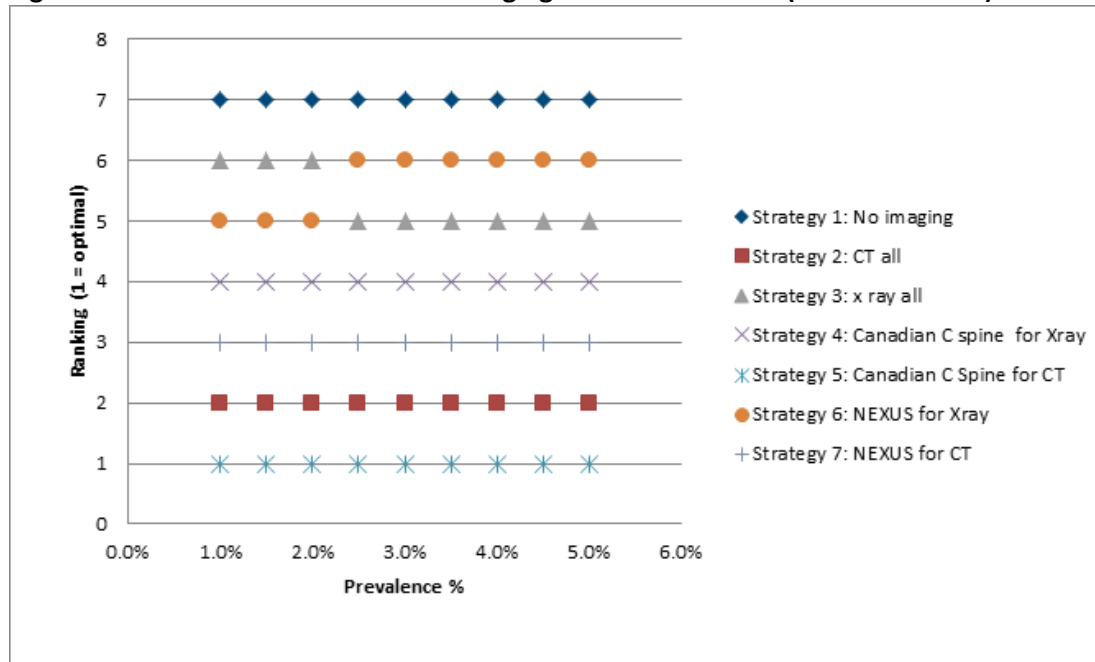

**Figure 77 DSA with Further Imaging Clinical Decision Scenarios after Initial CT/X-ray
(Prevalence 0.5%, Cohort N =1000)**

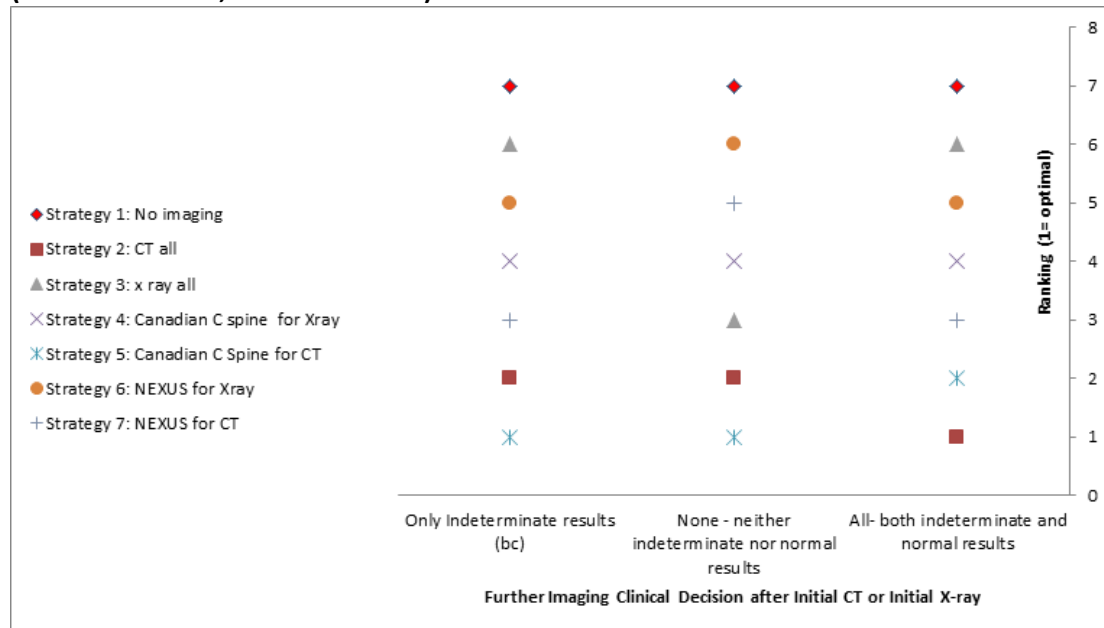

Appendix N: Research recommendations

- 1. Is the clinical outcome of patients with head injury with a reduced level of consciousness improved by direct transport from the scene of injury to a tertiary centre with neuroscience facilities compared with the outcome of those who are transported initially to the nearest hospital without neurosurgical facilities?**

Why this is important

Although this research recommendation was set in 2007, the GDG felt that it is still a high priority for research following this guideline update. No evidence review was conducted specifically for this question, but the GDG are aware that an HTA report (in press) has concluded that there is minimal evidence to support patients with signs suggestive of severe head injury being taken from the scene directly to neuroscience care, when this involves bypassing their nearest emergency department. Nevertheless, within current NHS England trauma systems some patients with apparent severe head injury are bypassing their nearest emergency department and experiencing prolonged journey times of up to 45 minutes in order to be taken directly to a neuroscience centre. For pre-hospital healthcare workers, and for the effective functioning of the new NHS trauma systems, it is important to define which, if any, patients would do better by being transported directly to a neuroscience centre.

Guidance will be required to define the patient population – for example, researchers may focus on age, or isolated head injury versus apparent multiple trauma. Further specification is needed about what level of consciousness would indicate the need for primary transfer to a neuroscience centre. Researchers should look at the impact of the duration of transport on study outcome, for example, less than 20 minutes, or where the additional journey time is less than 10 minutes. Criteria for selecting high-priority research recommendations:

Full PICO table, relevance, current evidence base etc not detailed as this is a question from the 2007 version of the guideline that has not been updated.

- 2. What is the clinical and cost effectiveness of the 2014 NICE guideline recommendation on CT head scanning versus clinical decision rules including CHALICE, CATCH and PECARN for selection of children and infants for head CT scan?**

Why this is important

The current NICE guideline for determining which patients need a CT head scan is based on the CHALICE clinical decision rule. CHALICE was derived in the UK but has yet to be validated, and limited evidence has been identified since the NICE clinical guideline was published in 2007. There is a need for a prospective validation and direct comparison of the 2014 NICE guideline and CHALICE, CATCH and PECARN clinical decision rules in a UK setting to determine diagnostic accuracy (sensitivity, specificity, and predictive values for intracranial injury and the need for neurosurgery) and cost effectiveness within the relevant population to which the NICE guideline is applied.

The study should be a prospective study with economic evaluation and should capture subgroups by age, separating out infants (under 2 years), children and young people (under 16 years) and adolescents (16–18 years). The results of such a study will confirm whether current practice is optimal and, if not, which would be the ideal clinical decision rule to implement in a UK population. To warrant recommendation of a different clinical decision rule and a consequent substantial change in practice, significant improvement in diagnostic

accuracy must be demonstrated. This can only be done through such a prospective comparative validation study performed in our population. Criteria for selecting high-priority research recommendations:

PICO question	Population: Children and infants with suspected head injury presenting in the emergency department (all severities of head injury) [subgroups: infants (<2), children/young people (<16) and adolescents (16 - 18)] Index test: CHALICE, PECARN, CATCH Reference standard: CT scan. Follow up at 2 weeks post injury, by structured telephone interview for those who did not have a CT scan. Outcome: Diagnostic accuracy of intracranial injury and need for neurosurgical intervention
Importance to patients or the population	Use of a clinical decision rule with a high specificity and sensitivity could lead to fewer false negatives i.e. cases of missed head injury and also a reduction in head CT scans, which would reduce patient stress and inconvenience should they be admitted to hospital and subsequently have a negative CT scan.
Relevance to NICE guidance	Should a different decision rule perform better than the CHALICE rule then this could lead to a change in recommendation. Conversely, should the CHALICE rule perform best, the current recommendation would be supported by high quality evidence.
Relevance to the NHS	Better targeting of resources in the management of children with head injury.
National priorities	Department of Health initiative on regional trauma networks.
Current evidence base	The current NICE clinical decision rule for selection of patients for CT scan is based on the CHALICE. There is a need for CHALICE to be validated and directly compared to other validated decision rules in a UK setting.
Equality	It is important to ensure that unnecessary CT scan should be avoided as children are more sensitive than adults to the damaging effects of radiation, and have a longer potential life span in which cancer could develop. The reference standard suggested for this research takes this into account a reasonable follow up period can be used as an alternative to a CT scan to detect head injury.
Study design	Prospective diagnostic cohort or randomised controlled trial. Power calculations should be conducted to establish the required sample size of the trial. It is important that the study is adequately powered to detect a clinically important effect size.
Feasibility	The GDG do not foresee any feasibility issues.
Other comments	Economic evaluation assessing the resource use and costs associated with the intervention (including the need for repeated scans), as well as those resulting from the diagnostic outcome (including admission and neurosurgery) should be undertaken. Patients with a negative finding should also be followed up for an appropriate amount of time and health resources used evaluated.
Importance	High priority

3. In patients with head injury does the use of antiplatelet and anticoagulant drugs increase the risk of intracranial haemorrhage over and above factors included in the current recommendations for CT head scans?

Why this is important

Antiplatelet and anticoagulant drugs are widely and increasingly prescribed, and many patients presenting with a head injury to the emergency department are taking these drugs. While the majority of these drugs are prescribed in older patients they are also used in younger people. This guideline provides recommendations on performing CT head scans in patients on warfarin. However, limited evidence has been identified for patients using other antiplatelet or anticoagulant drugs within studies deriving or validating clinical decision rules for determining which patients need CT head scans. There is a particular paucity of evidence in determining whether they are at increased risk of intracranial haemorrhage.

A study with appropriate economic evaluation is needed to quantify the risk of taking these drugs over and above the risk factors included in an existing clinical decision rule. Antiplatelet and anticoagulant drugs should be studied as a predictor of intracranial injury and analysed within a multivariate analysis with other predictors (including the risk factors used in this guideline to determine when a CT head scan is needed). Univariable analyses of risk of intracranial injury in groups of head injury patient who are / are not taking these agents and have no other indication for CT head scan under current guidance is also useful. The Guideline Development Group (GDG) felt that, where possible, each drug should be considered separately, particularly aspirin and clopidogrel, and that the reference standard should include CT head scan and a follow-up period of sufficient duration to capture delayed bleeding, for example, at 7 days and 1 month. Analysis would benefit from subgroup results by age (children, adults and patients over 65 years). The GDG suggested reporting similar data used in the AHEAD study (www.shef.ac.uk/scharr/sections/hsr/emergency/ahead).

Criteria for selecting high-priority research recommendations:

PICO question	Population:
	<ul style="list-style-type: none"> • Patients with head injury taking antiplatelet or anticoagulant drugs with suspected head injury presenting in the emergency department (all severities of head injury). • Pharmacological agents to consider either alone or as combinations: <ul style="list-style-type: none"> ○ Antiplatelets <ul style="list-style-type: none"> ▪ Abciximab ▪ Aspirin (300, 150, 75 mg?) ▪ Clopidogrel ▪ Dipyridamole ▪ Prasugrel ▪ Ticagrelor ▪ Tirofiban ○ Vitamin K antagonists: <ul style="list-style-type: none"> ▪ Acenocoumarol and phenprocoumon [phenprocoumon does not have a UK license] ▪ Phenindione ○ Direct factor Xa inhibitors <ul style="list-style-type: none"> ▪ Rivaroxaban ▪ Apixaban ○ Direct thrombin inhibitors

	<ul style="list-style-type: none"> ▪ Dabigatran ▪ Argatroban ○ Parenteral anticoagulants <ul style="list-style-type: none"> ▪ Heparin ▪ Low molecular weight heparin ▪ Epoprostenol <p>Index test:</p> <ul style="list-style-type: none"> • CT scan <p>Reference standard:</p> <ul style="list-style-type: none"> • CT scan and follow up at one month and (ideally) at six months post injury (for those where CT is not indicated or performed just follow up at one and six months post injury. Follow up can be done by telephone, checking hospital/patient records and checking death certificates.. <p>Outcomes:</p> <ul style="list-style-type: none"> • Incidence of intracranial injury where no current indication for CT scanning exists (any clinical intervention related to the head injury) • Incidence of definitive neurosurgical intervention including intracranial pressure monitoring where no current indication for CT scanning exists and excluding other disease. <p>Subgroups:</p> <ul style="list-style-type: none"> • Age: < 16, 16-64, > 65 • Drug class <p>Economic evaluation assessing the resource use and costs associated with the intervention (including the need for repeated scans), as well as those resulting from the diagnostic outcome (including admission and neurosurgery) should be undertaken. Patients with a negative finding should also be followed up for an appropriate amount of time and health resources used evaluated.</p>
Importance to patients or the population	To identify whether patients taking antiplatelet agents are at risk of developing an intracranial bleed (i.e. and therefore potentially a missed bleed), and therefore need to have a CT scan performed, or is it safe to observe and / or discharge the patient home without a CT scan (and reduce radiation burden for a patient /NHS costs).
Relevance to NICE guidance	Should this study highlight that patients receiving antiplatelet agents are at a risk of developing a bleed, this would need to be incorporated within the current NICE head injury decision rule; this subgroup of patients would therefore have a CT scan performed or be observed.
Relevance to the NHS	This depends on the result of the evidence which should clarify whether or not current guidance is cost-effective in relation to this patient group, or needs modification– by increasing the indications for CT head where ICER’s indicate this could prevent avoidable morbidity.
National priorities	Relevant to the roll out of the recent trauma networks and NHS outcomes framework
Current evidence base	The current NICE clinical decision rule for selection of patients for CT scan is based on the Canadian CT Head Rules. The evidence identified since the NICE recommendation was made in 2007 (NICE CG56) is limited and of low quality and does not include key antiplatelet agents for example, clopidogrel.

Equality	Although this question is predominantly aimed at adults (making up the majority of those who take antiplatelet agents) it is important to include children as there are incidences where they are prescribed these agents.
Study design	<ul style="list-style-type: none"> • Prospective cohort study • Retrospective analysis of prospectively collected data (provided it is possible to analyse patients who would not have been CT scanned according to NICE guideline criteria) <p>Power calculations should be conducted to establish the required sample size of the trial. It is important that the study is adequately powered to detect a clinically important effect size.</p>
Feasibility	The GDG would not anticipate any challenges to these feasibility elements.
Other comments	Other populations/groups to consider: <ul style="list-style-type: none"> • Alcoholics • People that have intrinsic bleeding disorders <p>Drugs that affect platelets or coagulant function as a side effect (for example, SSRIs)</p>
Importance	High priority. Whilst we have a developing knowledge and understanding of the information pertaining to formal anticoagulants, the prescription of antiplatelets is very common and in many patients living active lives; hence an increasing and continuing risk of (head) injury and need for clarity regarding management.

4. In adults with medium risk indications for brain injury under current NICE CT head injury guidance, what is the clinical and cost-effectiveness of using the diagnostic circulating biomarker S100B to rule out significant intracranial injury?

Why this is important:

Circulating biomarkers, if validated, could provide a convenient and clinically applicable aid to the diagnosis of mild traumatic brain injury (TBI) – a ‘troponin for the brain’. If such biomarkers were sufficiently sensitive as well as specific for injury type (separating patients with traumatic axonal injury (TAI) from those with contusions), panels of biomarkers might not only help to determine which patients need neuroimaging but also allow us to devise rational, cost-effective pathways for neuroimaging – perhaps reserving primary use of advanced MRI for patients who have TAI as these lesions are undetectable on CT head scans.⁵⁴⁰ In addition, the availability of quantifiable biomarkers, scaled with the severity of injury, could help clinicians monitor the progression of brain injury in patients with more severe TBI, help stratify patients for trials and therapies, and provide significant prognostic information across all severities of TBI.

There is low-quality clinical effectiveness data for using the biomarker S100B to rule out significant intracranial injury in patients in the emergency department. Current evidence suggests that there is variation in the use of biomarker tests, including in the timing of testing, the concentration of biomarker used as a diagnostic cut-off, protocols used for sample transport and storage, and the equipment used for biomarker assays in laboratories. A diagnostic study (using randomised or consecutively selected patients) is needed to investigate the role of S100B in patients with selected head injury patterns.

The GDG also recognised the potential utility use of near-patient testing for biomarker tests to reduce the time from injury and blood sampling to test results. In addition, the GDG would welcome an additional outcome of 3-month follow-up of functional outcome/post-concussion symptoms alongside this study with appropriate economic evaluation. This

research would provide UK-based evidence as to the potential benefit of biomarkers and any associated reduction in CT head scans and hospital admissions.

Criteria for selecting high-priority research recommendations:

<p>PICO question</p>	<p>Setting: Emergency department</p> <p>Population: All patients with medium risk indications for CT head scan under current NICE guidance(including infants, children and adults) with head injury (all severities). Adults and children should be stratified and analysed separately.</p> <p>Index test: S100B (sample taken within 3 hours). Near patient testing was thought to be more useful than a lab based diagnostic test, in order to reduce time from injury to testing to results.</p> <p>Reference standard: Head CT (for detection of CT lesions), MRI (for detection of traumatic axonal injury), or follow up (minimum of 1 month adults, 2 weeks children infants; for clinical sequelae).</p> <p>Outcome: Diagnostic accuracy of intracranial injury</p> <p>Economic evaluation assessing the resource use and costs associated with the intervention (including the need for repeated tests and scans where results are indeterminate), as well as those resulting from the diagnostic outcome (including admission and neurosurgery) should be undertaken. Patients with a negative finding should also be followed up for an appropriate amount of time and health resources used evaluated.</p>
<p>Importance to patients or the population</p>	<p>Missing intracranial bleeding is potentially catastrophic to patients therefore finding diagnostic tools that support early and accurate diagnosis is highly desirable. Finding a safe serum concentration within a diagnostic tool to exclude bleeding or to guide treatment would be the greatest support to clinicians. Use of biomarkers could lead to a reduction in head CT scans, which could reduce patient stress and inconvenience should they be admitted to hospital and subsequently have a negative CT scan. The GDG note that CT head scans in medium risk patients can take some hours to obtain so biomarker results could be available first. Timing will likely be highly variable depending on local CT infrastructure, whether scan is requested in working hours or out of hours etc. In addition to stratifying patients for neuroimaging, research might also be able to identify patients who have normal CT, but nevertheless are at risk of late cognitive and behavioural sequelae, and therefore merit more advanced neuroimaging, more intensive follow up, and/or participation in trials of new interventions.</p>
<p>Relevance to NICE guidance</p>	<p>High quality evidence may lead to the current review question on biomarkers being updated and help decide whether there are benefits to using biomarkers and if so to endorse further research into including them as part of a clinical decision rule for selecting patients with head injury for imaging. The GDG did not wish to support adoption of their use following a review of the evidence at this time.</p>
<p>Relevance to the NHS</p>	<p>Biomarkers are already used in clinical practice for other conditions outside of their potential role in head injury. As a result some of the potential costs in relation to implementation may have already been addressed. An ideal would be to develop near patient testing to support effective triaging of patients. i.e. is it safe to wait to see certain patients or should their care be fast-tracked? This approach would also overcome the issue currently related to the testing 'window'. When some patients are at the scene of the injury for some time or when it takes up to 1 to 2 hours to transfer a patient to hospital and then there is a subsequent wait for clinical assessment, it can often mean that it may be beyond three hours when a sample is taken. Their potential ability to rule out</p>

	the need to CT head scan in medium risk patients is also highly desirable
National priorities	Regional Trauma systems are currently being implemented across NHS England. This research question could improve these systems by earlier identification of traumatic brain injury, and contributing to more rational referral pathways for mild to moderate TBI.
Current evidence base	There is low quality clinical effectiveness for using diagnostic biomarker S100B to rule out head injury in patients in the emergency department. Current evidence suggests variation in the use of biomarker tests including timing, concentration of biomarker used as a diagnostic cut-off and equipment used for storage and assessment of biomarkers within the laboratory.
Equality	Unnecessary CT scans should not be performed, especially in children, due to radiation risk. The reference standard suggested for this research takes this into account that a reasonable follow up period could be used as an alternative to a CT scan to detect significant intracranial injury.
Study design	Diagnostic cohort or randomised controlled trial. Power calculations should be conducted to establish the required sample size of the trial. It is important that the study is adequately powered to detect a clinically important effect size.
Feasibility	Because of the low incidence of CT abnormalities any research proposal should contain a feasibility element
Other comments	This question is part of a large international collaborative venture (the International Traumatic Brain Injury Research initiative; InTBIR, which is attracting a total of ~\$50 million funding from the European Commission, NIH and CIHR over the next 5-7 years. It may be useful to allow that process to mature a little, so that decisions regarding the articulation of research questions and funding provision are complementary to those international efforts. For details see: http://ec.europa.eu/research/health/medical-research/brain-research/international-initiative_en.html http://www.cihr-irsc.gc.ca/e/45665.html http://www.ninds.nih.gov/funding/funding_announcements/rfa/RFA-NS-13-008.htm
Importance	Potentially high – if the technology is validated, it could substantially change management pathways for mild TBI. Conversely, failure to produce high quality evidence synthesis could result in poorly validated technology creeping into use with substantial cost implications.

5. Research is needed to summarise and identify the optimal predictor variables for long term sequelae following mild traumatic brain injury. A systematic review of the literature could be used to derive a clinical decision rule to identify, at the time of injury, relevant patients. This would in turn lay the foundation for a derivation cohort study.

1.1.1.1 Why this research is important

We performed a review of the literature in this area, repeated in this update process. While 394 studies were identified that attempted to use a wide range of variables and tests to predict a range of longer term outcome measures, no robust clinical decision tools has successfully been derived and validated to identify patients at the time of injury who could be considered for follow-up due to a higher risk of long term sequelae. A systematic review of the literature would summarise and identify the optimal predictor variables for such a clinical decision rule and also identify the optimal outcome variables, thus laying the foundation for a derivation cohort study.

The derivation cohort study to create this clinical decision rule could potentially be conducted in conjunction with the validation of the CHALICE rule, with follow up of patients involved in this study at 6mths-1yr. This would ensure optimal value for money for funders and ensure good results in a large cohort of patients. Separate studies could also be performed in adults but the initial study may in fact be more urgent in the childhood population.

Identification of patients likely to suffer from long term sequelae will allow targeted research regarding responsiveness to, or effectiveness of focused rehabilitation programmes. Preventative action could potentially be taken, thus reducing the strain on resources further down the care pathway. Furthermore, patient outcomes could potentially be improved by early identification and treatment (both curative and preventive) of problems. However, further research is required before we can be certain that a robust framework exists with which to cope with individuals identified by the clinical decision rule proposed above.

Update 2014

Although this recommendation was first made in 2007, the GDG felt that this is still an area of high priority for research and the question remains unanswered. The diagnosis of traumatic brain injury is essentially a clinical one.^{304,433} However, although this approach provides the best current solution it can be imprecise, particularly in mild traumatic brain injury (TBI), where conventional imaging may be normal and cognitive abnormalities may be due to confounders such as pre-existing dementia, hypoxia or hypotension from associated injuries, alcohol or recreational drugs, and/or other conditions (such as post-traumatic stress disorder) which result in overlapping phenotypes (and possibly even imaging findings).⁴³³

The availability of novel, objective methods of detecting brain injury provides an attractive means of better defining the presence of TBI in these contexts, with improvements in epidemiological precision. Perhaps more importantly, there is an increasing recognition that even mild TBI can result in prolonged cognitive and behavioural deficits,^{42,70,110,203,263,468,512} and the ability to identify patients at risk of these sequelae would aid clinical management, help determine which patients need novel therapeutic interventions, and refine resource allocation. The techniques that have been explored in this regard include advanced neuroimaging with magnetic resonance imaging (MRI), electroencephalographic (EEG) based diagnosis, and circulating biomarkers. The relative effectiveness and cost-effectiveness of these techniques, individually and in combination, is not yet completely defined, and their role in contributing to a clinical decision rule that allows triage of patients to specific management pathways needs definition. A systematic review would be the first step in collating the available evidence in this area, followed by a rational application of available evidence, identification of key research questions that need to be addressed, and definition of the data collection needed in a derivation cohort study that allows these questions to be addressed.

Criteria for selecting high-priority research recommendations:

Full PICO table, relevance, current evidence base etc. not detailed as this is a question from the 2007 version of the guideline that has not been updated.

Appendix O: 2003 and 2007 guideline appendices

O.1 Text removed from CG56 (2007 guideline)	227
O.2 Remit and scope	276
O.3 Declarations of Interest	279
O.4 Key Clinical Questions included in the update	280
O.5 Search strategies	281
O.6 Suggested written discharge advice	295
O.7 Evidence tables	301
O.8 Adult observation proforma	564
O.9 Paediatric observation proformas	565
O.10 Letter of referral to neurosurgical department	566
O.11 The Glasgow Coma Scale for adults	567
O.12 Paediatric version of the Glasgow Coma Scale	568
O.13 Deleted and amended recommendations	569

O.1 Text removed from CG56 (2007 guideline)

O.1.1 Forward

Updating a document can be more difficult than starting from scratch; certainly we have found incorporation of new evidence into the guideline first published by NICE four years ago to be more complex than initially envisaged. I thank the Guideline Development Group and the team at the National Acute Care Collaboration Centre for their enthusiastic and professional support and advice throughout this process. We have been helped in our task by contributions from patient groups and stakeholders. The final document is undoubtedly richer as a result of the extensive consultations which followed the publication of the first draft.

Perhaps the most important prompt for this update was the publication of validation studies related to the advice on CT imaging; one of the most significant components of the first Guidance. New research evidence on the management of paediatric head injuries was also available and this has been particularly useful in clarifying the subtle differences in guidance for adults and children.

Emerging evidence on the value of CT in cervical spine imaging – and the increasing awareness that plain films may not reveal clinically important lesions – has led the Guideline Development Group to recommend greater use of CT in the assessment of the neck in those head injured patients who have impaired consciousness.

The transfer of critically ill or injured patients between hospitals is rarely out of the news and it has been an agenda item at our meetings throughout the update process. There are two issues. Should ambulances “by pass” local hospitals en route from the scene of an incident to reach a specialist centre? Secondly, if all patients continue, as at present, to be transported to the nearest hospital, what are the indications for “secondary transfer”? The evidence in both areas is weak – but there is more than there was four years ago. On balance the Guideline Development Group consider the case for transferring all seriously head injured patients to a specialist neuroscience centre to be sufficiently strong to recommend that “secondary transfer” should be the norm for this group of patients, irrespective of the need for a neurosurgical operation. In contrast, we do not consider the case has been made for “by pass”. Both issues are critically important; there is an urgent need for a stronger evidence base. We therefore recommend research in this area be given high priority.

The plight of those disabled after brain injury continues to cause concern. Our remit prevented a detailed examination of this important topic but we do comment on the indications for follow up and emphasise the need for further research.

Finally, we have taken the opportunity to review all sections of the previous document, addressing issues which have caused concern to users. I hope this update is even more helpful than its predecessor and that it will contribute to the improved care of head injured patients to which we all aspire.

Professor David Yates

Chair, Guideline Development Group

1st June 2007

O.1.2 Conflict of interests (2003 and 2007)

The Guideline Development Group were asked to declare any possible conflict of interest they might have that could interfere with their work on the guideline. No conflicts of interest were declared.

O.1.3 Stakeholder involvement

The following stakeholders commented on draft versions of these guidelines (2003):

- Brain and Spine Foundation
- British Association of Oral and Maxillofacial Surgeons
- British Dietetic Association
- British Medical Association
- British Orthopaedic Association
- British Paediatric Neurology Association
- British Psychological Society, The
- British Society of Rehabilitation Medicine
- Department of Health and Welsh Assembly Government
- Faculty of Public Health Medicine
- Headway - The Brain Injury Association
- Independent Healthcare Association
- Leeds General Infirmary
- Patient Involvement Unit
- Royal College of Anaesthetists
- Royal College of General Practitioners
- Royal College of Nursing
- Royal College of Ophthalmologists
- Royal College of Paediatrics and Child Health
- Royal College of Physicians
- Royal College of Psychiatrists
- Royal College of Speech and Language Therapists
- Society of British Neurological Surgeons
- Staffordshire Ambulance HQ
- Victim Support
- Walton Centre for Neurology and Neurosurgery NHS Trust
- Welsh Ambulance Trust Headquarters
- Wessex Neurological Centre

The following stakeholders registered with NICE and were invited to comment on draft versions of these guidelines (2007):

- 5 Boroughs Partnership NHS Trust
- Acute Care Collaborating Centre

- Addenbrooke's NHS Trust
- Adults Strategy and Commissioning Unit
- Aintree Hospitals NHS Trust
- Association for Spina Bifida & Hydrocephalus (ASBAH)
- Association of British Neurologists
- Association of the British Pharmaceuticals Industry,(ABPI)
- Barnsley Acute Trust
- Barnsley PCT
- Biophausia AB
- Bradford & Airedale Primary Care Trust
- British and Irish Orthoptic Society
- British Association for Counselling and Psychotherapy (BACP)
- British Association of Neuroscience Nurses
- British Dietetic Association
- British National Formulary (BNF)
- British Paediatric Mental Health Group of the Royal College of Paediatrics and Child Health
- British Paediatric Neurology Association
- British Paramedic Association
- British Psychological Society, The
- British Society of Interventional Radiology
- British Society of Neuroradiologists
- British Society of Rehabilitation Medicine
- Calderdale and Huddersfield Acute Trust
- CASPE Research
- Chartered Society of Physiotherapy (CSP)
- Childrens Acute Transport Service
- Chronic Conditions Collaborating Centre
- Clinical Effectiveness Committee
- Clinovia Ltd
- College of Emergency Medicine
- College of Occupational Therapists
- Commission for Social Care Inspection
- Community Practitioners and Health Visitors Association
- Connecting for Health
- Conwy & Denbighshire Acute Trust
- Cornwall Acute Trust
- Cyrenians
- Department for Education and Skills
- Department of Health
- Derbyshire Mental Health Trust

- Dudley Group of Hospitals NHS Trust
- East and North Herts NHS Trust
- Eaton Foundation
- Faculty of Dental Surgery
- Gloucestershire Partnership NHS Trust
- Good Hope Hospitals NHS Trust
- Great Ormond Street Hospital for Children NHS Trust
- Hampshire PCT
- Headway - The Brain Injury Association
- Health and Safety Executive
- Health Commission Wales
- Healthcare Commission
- Heart of England NHS Foundation Trust
- Help the Hospices
- Hertfordshire Partnership NHS Trust
- Huntleigh Healthcare
- Institute of Physics and Engineering in Medicine
- King's College Acute Trust
- Kingston PCT
- Leeds Teaching Hospitals NHS Trust
- Liverpool PCT
- Luton and Dunstable Hospital NHS Trust
- Maidstone and Tunbridge Wells NHS Trust
- Medicines and Healthcare Products Regulatory Agency (MHRA)
- Mental Health Act Commission
- Mental Health Collaborating Centre
- Mental Health Nurses Association
- National Institute for Mental Health in England (NIMHE)
- National Patient Safety Agency
- National Public Health Service - Wales
- National Treatment Agency for Substance Misuse
- NCC for Cancer
- NCCHTA
- NCEPOD
- NHS Direct
- NHS Health and Social Care Information Centre
- NHS Pathways
- NHS Plus
- NHS Quality Improvement Scotland
- North Cumbria Acute Hospitals NHS Trust
- North Staffordshire Combined Healthcare NHS Trust

- Northwest London Hospitals NHS Trust
- Nottingham City PCT
- Novo Nordisk Limited
- Nursing & Supportive Care Collaborating Centre
- Nutricia Ltd (UK)
- Oxfordshire & Buckinghamshire Mental Health Trust
- Patient and Public Involvement Programme for NICE
- PERIGON (formerly The NHS Modernisation Agency)
- Primary Care Collaborating Centre
- Primary Care Neurology Society
- Regional Public Health Group - London
- Royal College of General Practitioners
- Royal College of Nursing
- Royal College of Paediatrics and Child Health
- Royal College of Pathologists
- Royal College of Physicians of London
- Royal College of Radiologists
- Royal College of Speech and Language Therapists
- Royal National Hospital For Rheumatic Diseases
- Royal United Hospital Bath NHS Trust
- Saracen Care Services
- Scottish Intercollegiate Guidelines Network (SIGN)
- Sheffield Children's Hospital Trust
- Sheffield PCT
- Sheffield Teaching Hospitals NHS Foundation Trust
- Society of British Neurological Surgeons
- South Manchester University Hospitals NHS Trust
- St George's Healthcare NHS Trust
- Staffordshire Ambulance HQ
- Staffordshire Ambulance Service NHS Trust
- Staffordshire Moorlands PCT
- Stockport PCT
- Tameside and Glossop Acute Trust
- The Association of the British Pharmaceutical Industry (ABPI)
- The British Psychological Society
- The Chartered Society of Physiotherapy
- The Confidential Enquiry into Maternal & Child Health (CEMACH)
- The David Lewis Centre
- The North West London Hospitals NHS Trust
- The Robert Jones & Agnes Hunt Orthopaedic & District Hospital NHS Trust
- The Royal Society of Medicine

- The Stroke Association
- Tissue Viability Nurses Association
- UK Specialised Services Public Health Network
- University College London Hospitals (UCLH) Acute Trust
- University Hospital Birmingham NHS Trust
- Vitaline Pharmaceuticals UK Ltd
- Walsall PCT
- Walton Centre for Neurology and Neurosurgery NHS Trust
- Welsh Assembly Government
- Welsh Scientific Advisory Committee (WSAC)
- Wessex Neurological Centre
- Wirral Hospital Acute Trust
- Withybush Hospital
- Women's & Children's Collaborating Centre

O.1.4 Guideline Review Panel (2007)

The Guideline Review Panel is an independent panel that oversees the development of the guideline and takes responsibility for monitoring its quality. The members of the Guideline Review Panel were as follows:

Mr Peter Robb

Consultant ENT Surgeon, Epsom and St Helier University Hospitals and The Royal Surrey County NHS Trusts

Dr Christine Hine

Consultant in Public Health (Acute Commissioning), Bristol and South Gloucestershire PCTs

Mr Mike Baldwin

Project Development Manager, Cardiff Research Consortium

Mr John Seddon

Patient representative

Mrs Jill Freer

Acting Director of Provider Services, NHS Warwickshire

O.1.5 The need for this update guideline

Up to 2 years after publication of all NICE guidelines any new evidence is considered for relevance and importance. The original guideline was produced in June 2003 and this current version is the 2 year partial update of the previous guideline. There was sufficient new evidence to prompt an update to be carried out. This update affects only a few recommendations within the original guideline.

New evidence has been incorporated using the latest version of the NICE technical manual (April 2006). The original guideline was produced using standard methodology between

2001-03, prior to the first version of the NICE technical manual. In this update we have not sought to revisit previously reviewed literature and recommendations except in the areas that we are updating. The write up of sections that we have not updated has not been amended and we have added sections only where an update was needed. A full update will be considered 2 years after publication of this version.

O.1.6 What are clinical practice guidelines?

Our clinical guidelines are recommendations for the care of individuals in specific clinical conditions or circumstances within the NHS – from prevention and self-care through primary and secondary care to more specialised services. We base our clinical guidelines on the best available research evidence, with the aim of improving the quality of healthcare. We use predetermined and systematic methods to identify and evaluate the evidence relating to specific clinical questions.

Clinical guidelines can:

- provide recommendations for the treatment and care of people by health professionals
- be used to develop standards to assess the clinical practice of individual health professionals
- be used in the education and training of health professionals to help patients to make informed decisions
- improve communication between patient and health professional

While guidelines assist the practice of healthcare professionals, they do not replace their knowledge and skills. We produce our guidelines using the following steps:

- Guideline topic is referred to NICE from the Department of Health
- Stakeholders register an interest in the guideline and are consulted throughout the development process.
- The scope is prepared by the National Collaborating Centre for Acute Care
- The National Collaborating Centre for Acute Care establish a guideline development group
- A draft guideline is produced after the group assesses the available evidence and makes recommendations
- There is a consultation on the draft guideline.
- The final guideline is produced.

The National Collaborating Centre for Acute Care and NICE produce a number of versions of this guideline:

- the full guideline contains all the recommendations, plus details of the methods used and the underpinning evidence
- the NICE guideline presents the recommendations from the full version in a format suited to implementation by health professionals and NHS bodies
- the quick reference guide presents recommendations in a suitable format for health professionals
- information for the public is written using suitable language for people without specialist medical knowledge.

This version is the full version. The other versions can be downloaded from our website at www.rcseng.ac.uk/surgical_research_units/nccac/ or are available from NICE www.NICE.org.uk.

O.1.7 The National Collaborating Centre for Acute Care

This guideline was commissioned by NICE and developed by the National Collaborating Centre for Acute Care. The centre is one of seven national collaborating centres funded by NICE and comprises a partnership between a variety of academic, professional and patient-based organisations. As a multidisciplinary centre we draw upon the expertise of the healthcare professions and academics and ensure the involvement of patients in our work. Further information on the centre and our partner organisations can be found at our website. (www.rcseng.ac.uk/surgical_research_units/nccac/)

O.1.8 Who developed this guideline?

A multidisciplinary Guideline Development Group (GDG) comprising professional group members and consumer representatives of the main stakeholders developed this guideline (see section on Guideline Development Group Membership and acknowledgements).

The National Institute for Health and Clinical Excellence (NICE) funds the National Collaborating Centre for Acute Care (NCC-AC) and thus supported the development of this guideline. The GDG was convened by the NCC-AC and chaired by Professor David Yates in accordance with guidance from NICE.

The group met every 6-8 weeks during the development of the guideline. At the start of the guideline development process all GDG members declared interests including consultancies, fee-paid work, share-holdings, fellowships and support from the healthcare industry. At all subsequent GDG meetings, members declared arising conflicts of interest, which were also recorded (Appendix B). Members are either required to withdraw completely or for part of the discussion if their declared interest makes it appropriate, however this was not deemed necessary for any group members on this guideline.

Staff from the NCC-AC provided methodological support and guidance for the development process. They undertook systematic searches, retrieval and appraisal of the evidence and drafted the guideline. The glossary to the guideline contains definitions of terms used by staff and the GDG.

O.1.9 Methods

O.1.9.1 Systematic reviews

The systematic reviews performed for these guidelines were designed to identify different types of clinical decision rule. The studies reviewed included derivation designs (usually cohort studies where the predictive power of a number of prognostic variables were explored) and validation designs (where the sensitivity and specificity of previously defined rules were examined). Data collection may have been prospective or retrospective. The follow-up rate for important outcomes was also recorded: a standard of at least 80% follow-up is often stated for studies on the development of clinical decision rules. The use of multivariate statistics to identify the independent contribution of each variable to the rules was also an important determinant of study quality. Systematic reviews of studies on the development of clinical decision studies and/or prognostic variables in head injury were also sought.

The Guideline Development Group agreed to use classifications adapted from the Oxford Centre for Evidence-based Medicine Levels of Evidence (May 2001), to summarise the evidence levels for reviewed studies. These differ from the levels of evidence normally used by NICE, as the NICE classification is not suitable for certain study designs.

The levels of evidence used for studies on the development of clinical decision rules were as follows:

1. Cohort study with consecutive patients and good reference standards, used to validate clinical decision rules;
2. Cohort study with consecutive patients and good reference standards used to derive clinical decision rules (or validated on split samples only);
3. Non-consecutive study or without consistently applied reference standards;
4. Case-control study, poor or non-independent reference standard;
5. Expert opinion without explicit critical appraisal, or based on physiology, bench research or "first principles".

The levels of evidence used for systematic reviews were as follows:

1. Systematic review (with homogeneity) of mostly Level 1 studies
2. Systematic review (with homogeneity) of mostly Level 2 studies
3. Systematic review (with homogeneity) of mostly Level 3 studies

It was also agreed to adopt the Oxford Centre for Evidence-based Medicine classification for grade of recommendations (May 2001). This was used so that consistency with the levels of evidence classification could be achieved.

The grades of recommendation used in this guideline are as follows:

- A. Consistent level 1 studies
- B. Consistent level 2 or 3 studies or extrapolations from level 1 studies
- C. Level 4 studies or extrapolations from level 2 or 3 studies
- D. Level 5 evidence or troublingly inconsistent or inconclusive studies of any level

O.1.9.2 Prioritisation of recommendations for implementation

To assist users of the guideline in deciding the order in which to implement the recommendations, the GDG identified up to ten key priorities for implementation. The decision was made after discussion and voting by the GDG. They selected recommendations that would:

- Have a high impact on patient outcomes, including mortality and morbidity
- Have a high impact on reducing variation
- Lead to a more efficient use of NHS resources
- Mean patients reach critical points in the care pathways more quickly

O.1.9.3 Validation of the guideline

Registered stakeholders were given the opportunity to comment on the draft guideline, which was posted on the NICE website. A Guideline Review Panel also reviewed the guideline and checked that stakeholders' comments had been addressed.

O.1.9.4 Updating the guideline

NICE clinical guidelines are updated as needed so that recommendations take into account important new information. We check for new evidence 2 and 4 years after publication, to decide whether all or part of the guideline should be updated. If important new evidence is published at other times, we may decide to do a more rapid update of some recommendations.

O.1.10 Summary of recommendations

Below are the recommendations that the GDG selected as the key priorities for implementation followed by the full list of recommendations.

O.1.10.1 Key Priorities for Implementation

Training in risk assessment

It is recommended that General Practitioners, nurses, dentists and ambulance crews should receive training, as necessary, to ensure that they are capable of assessing the presence or absence of the risk factors listed in section 3.3.2. [Amended] [Recommendation 3.2.3.1]

Pre-hospital management

Patients who have sustained a head injury should be transported directly to a facility that has been identified as having the resources necessary to resuscitate, investigate and initially manage any patient with multiple injuries. It is expected that all acute hospitals and all neuroscience units accepting patients directly from the incident will have these resources, and that these resources will be appropriate for the patient's age. [NEW] [3.4.2.5]

Initial assessment in the emergency department

All patients presenting to an emergency department with a head injury should be assessed by a trained member of staff within a maximum of 15 minutes of arrival at hospital. Part of this assessment should establish whether they are high risk or low risk for clinically important brain injury and/or cervical spine injury, using the guidance on patient selection and urgency for imaging (head and neck cervical spine – see later recommendations). [3.5.1.6]

Selecting patients for CT imaging of the head

Adult patients who have sustained a head injury and present with any one of the following risk factors should have CT scanning of the head requested immediately.

- GCS less than 13 on initial assessment in the emergency department.
- GCS less than 15 at 2 hours after the injury on assessment in the emergency department.
- Suspected open or depressed skull fracture.
- Any sign of basal skull fracture (haemotympanum, 'panda' eyes, cerebrospinal fluid otorrhoea, Battle's sign).
- Post-traumatic seizure.
- Focal neurological deficit.
- More than one episode of vomiting.
- Amnesia for greater than 30 minutes of events before impact. [Amended] [3.5.3.1]

For children:

Children (under 16 years) who have sustained a head injury and present with any one of the following risk factors should have CT scanning of the head requested immediately.

- Loss of consciousness lasting more than 5 minutes (witnessed by a healthcare professional).
- Amnesia (antegrade or retrograde) lasting more than 5 minutes.
- Abnormal drowsiness.
- 3 or more discrete episodes of vomiting.
- Clinical suspicion of non-accidental injury.
- Post-traumatic seizure but no history of epilepsy.
- Glasgow Coma Score (GCS) less than 14, or for a baby under 1 year GCS (paediatric) less than 15, on assessment in the emergency department.
- Suspicion of open or depressed skull injury or tense fontanelle.
- Any sign of basal skull fracture (haemotympanum, 'panda' eyes, cerebrospinal fluid otorrhoea, Battle's sign).
- Focal neurological deficit.
- If under 1 year, presence of bruise, swelling or laceration (more than 5 cm) on the head.
- Dangerous mechanism of injury (high-speed road traffic accident either as pedestrian, cyclist or vehicle occupant, fall from a height of greater than 3 metres, high-speed injury from a projectile or an object). [NEW] [3.5.3.3]

Selecting patients for CT imaging of cervical spine

The current initial investigation of choice for the detection of injuries to the cervical spine is the plain radiograph. Three views should be obtained and be of sufficient quality for reliable interpretation. However, in certain circumstances CT is preferred. [Amended] [3.5.5.1]

Adult patients who have any of the following risk factors should have CT imaging of the cervical spine requested immediately:

- patients with a GCS below 13 on initial assessment
- those that have been intubated
- plain film series is technically inadequate (for example, desired view unavailable), suspicious or definitely abnormal
- there is continued clinical suspicion of injury despite a normal X-ray
- a definitive diagnosis of cervical spine injury is required urgently (for example, prior to surgery) and the patient is having other body areas scanned for head injury or multi-region trauma. [NEW] [3.5.6.2]

Children aged 10 years or more can be treated as adults for the purposes of cervical spine imaging. [3.5.6.3]

In children under 10 years, because of the increased risks associated with irradiation, particularly to the thyroid gland, and the generally lower risk of significant spinal injury, CT of the cervical spine should only be used in cases where patients have a severe head injury (GCS 8 or less), or where there is a strong clinical suspicion of injury despite normal plain films (for example, focal neurological signs or paraesthesia in the extremities), or cases where there is a strong suspicion of injury and plain films are inadequate. [NEW] [3.5.6.6]

Organisation of transfer of patients between receiving hospital and neuroscience unit

Local guidelines on the transfer of patients with head injuries should be drawn up between the referring hospital trusts, the neuroscience unit and the local ambulance service. These should be consistent with established national guidelines and recognise that such transfer is indicated for all seriously head injured patients (GCS 8 or less). Details of the transfer of the responsibility for patient care should also be agreed. [Amended] [3.6.1.1]

Advice about long term problems and support services

All patients and their carers should be made aware of the possibility of long term symptoms and disabilities following head injury and should be made aware of the existence of services that they could contact should they experience long term problems. Details of support services should be included on patient discharge advice cards. [Amended] [3.8.10.1]

O.1.10.2 The complete list of clinical practice recommendations

Glasgow Coma Scale

The assessment and classification of patients who have sustained a head injury should be guided primarily by the adult and paediatric versions of the Glasgow Coma Scale and its derivative the Glasgow Coma Score. Recommended versions are shown in Appendix M and Appendix N. Good practice in the use of the Glasgow Coma Scale and Score should be adhered to at all times, following the principles below.

Monitoring and exchange of information about individual patients should be based on the three separate responses on the GCS (for example, a patient scoring 13 based on scores of 4 on eye-opening, 4 on verbal response and 5 on motor response should be communicated as E4, V4, M5). (D)

If a total score is recorded or communicated, it should be based on a sum of 15, and to avoid confusion this denominator should be specified (for example, 13/15). (D)

The individual components of the GCS should be described in all communications and every note and should always accompany the total score. (D)

The paediatric version of the GCS should include a 'grimace' alternative to the verbal score to facilitate scoring in pre-verbal or intubated patients. (D)

Best practice in paediatric coma observation and recording as detailed by the National Paediatric Neuroscience Benchmarking Group should be followed at all times. (these principles are detailed in Appendix N). (D)

Public health literature

Public health literature and other non-medical sources of advice (for example, St John Ambulance, police officers) should encourage people who have any concerns following a head injury to themselves or to another person, regardless of the injury severity, to seek immediate medical advice. (D)

Training in risk assessment

It is recommended that General Practitioners, nurses, dentists and ambulance crews should receive training, as necessary, to ensure that they are capable of assessing the presence or absence of the risk factors listed in section. [Amended] (D)

Support for families and carers

There should be a protocol for all staff to introduce themselves to family members or carers and briefly explain what they are doing. In addition a photographic board with the names and titles of personnel in the hospital departments caring for patients with head injury can be helpful. (D)

Information sheets detailing the nature of head injury and any investigations likely to be used should be available in the emergency department. The patient version of these NICE guidelines may be helpful. (D)

Staff should consider how best to share information with children and introduce them to the possibility of long term complex changes in their parent or sibling. Literature produced by patient support groups may be helpful. (D)

Healthcare professionals should encourage carers and relatives to talk and make physical contact (for example, holding hands) with the patient. However, it is important that relatives and friends do not feel obliged to spend long periods at the bedside. If they wish to stay with the patient, they should be encouraged to take regular breaks. [Amended] (D)

There should be a board or area displaying leaflets or contact details for patient support organisations either locally or nationally to enable family members to gather further information. (D)

Presentation and referral

A person with a head injury may present via a telephone advice service or to a community health service or minor injury clinic. The following recommendations apply in these settings.

Telephone advice lines

Telephone advice services (for example, NHS Direct, emergency department helplines) should refer people who have sustained a head injury to the emergency ambulance services (that is, 999) for emergency transport to the emergency department if they have experienced any of the following (alternative terms to facilitate communication are in parenthesis).

- Unconsciousness, or lack of full consciousness (for example, problems keeping eyes open).
- Any focal (that is, restricted to a particular part of the body or a particular activity) neurological deficit since the injury (examples include problems understanding, speaking, reading or writing; loss of feeling in part of the body; problems balancing; general weakness; any changes in eyesight; and problems walking).
- Any suspicion of a skull fracture or penetrating head injury (for example, clear fluid running from the ears or nose, black eye with no associated damage around the eye, bleeding from one or both ears, new deafness in one or both ears, bruising behind one or both ears, penetrating injury signs, visible trauma to the scalp or skull).
- Any seizure ('convulsion' or 'fit') since the injury.

- A high energy head injury (for example, pedestrian struck by motor vehicle, occupant ejected from motor vehicle, a fall from a height of greater than 1 metre or more than five stairs, diving accident, high-speed motor vehicle collision, rollover motor accident, accident involving motorised recreational vehicles, bicycle collision, or any other potentially high energy mechanism). A lower threshold for height of falls should be used when dealing with infants and young children (that is, aged under 5 years).
- The injured person or their carer is incapable of transporting the injured person safely to the hospital emergency department without the use of ambulance services (providing any other risk factors indicating emergency department referral are present). (D)

Telephone advice services (for example, NHS Direct, emergency department helplines) should refer people who have sustained a head injury to a hospital emergency department if the history related indicates the presence of any of the following risk factors (alternative terms to facilitate communication are in parenthesis).

- Any previous loss of consciousness ('knocked out') as a result of the injury, from which the injured person has now recovered.
- Amnesia for events before or after the injury ('problems with memory'). The assessment of amnesia will not be possible in pre-verbal children and is unlikely to be possible in any child aged under 5 years.
- Persistent headache since the injury.
- Any vomiting episodes since the injury.
- Any previous cranial neurosurgical interventions ('brain surgery').
- History of bleeding or clotting disorder.
- Current anticoagulant therapy such as warfarin.
- Current drug or alcohol intoxication.
- Age greater than or equal to 65 years.
- Suspicion of non-accidental injury.
- Irritability or altered behaviour ('easily distracted' 'not themselves' 'no concentration' 'no interest in things around them') particularly in infants and young children (that is, aged under 5 years).
- Continuing concern by the helpline personnel about the diagnosis. (D)

In the absence of any of the factors listed in 3.3.1.1 and 3.3.1.2, the helpline should advise the injured person to seek medical advice from community services (for example, General Practice) if any of the following factors are present.

- Adverse social factors (for example, no-one able to supervise the injured person at home).
- Continuing concern by the injured person or their carer about the diagnosis. (D)

Community health services and NHS minor injury clinics

Community health services (General Practice, ambulance crews, NHS walk-in centres, dental practitioners) and NHS minor injury clinics should refer patients who have sustained a head injury to a hospital emergency department, using the ambulance service if deemed necessary (see section 3.4.1), if any of the following are present.

- GCS less than 15 on initial assessment
- Any loss of consciousness as a result of the injury.

- Any focal neurological deficit since the injury (examples include problems understanding, speaking, reading or writing; decreased sensation; loss of balance; general weakness; visual changes; abnormal reflexes; and problems walking).
- Any suspicion of a skull fracture or penetrating head injury since the injury (for example, clear fluid running from the ears or nose, black eye with no associated damage around the eyes, bleeding from one or both ears, new deafness in one or both ears, bruising behind one or both ears, penetrating injury signs, visible trauma to the scalp or skull of concern to the professional).
- Amnesia for events before or after the injury. The assessment of amnesia will not be possible in pre-verbal children and is unlikely to be possible in any child aged under 5 years.
- Persistent headache since the injury.
- Any vomiting episodes since the injury (clinical judgement should be used regarding the cause of vomiting in those aged 12 years or younger, and the need for referral).
- Any seizure since the injury.
- Any previous cranial neurosurgical interventions.
- A high energy head injury (for example, pedestrian struck by motor vehicle, occupant ejected from motor vehicle, a fall from a height of greater than 1 metre or more than five stairs, diving accident, high-speed motor vehicle collision, rollover motor accident, accident involving motorized recreational vehicles, bicycle collision, or any other potentially high energy mechanism). A lower threshold for height of falls should be used when dealing with infants and young children (that is, aged under 5 years).
- History of bleeding or clotting disorder.
- Current anticoagulant therapy such as warfarin.
- Current drug or alcohol intoxication.
- Age greater than or equal to 65 years.
- Suspicion of non-accidental injury.
- Continuing concern by the professional about the diagnosis. [Amended] (D)

In the absence of any the factors listed in 3.3.2.1, the professional should consider referral to an emergency department if any of the following factors are present depending on their own judgement of severity.

- Irritability or altered behaviour, particularly in infants and young children (that is, aged under 5 years).
- Visible trauma to the head not covered above but still of concern to the professional.
- Adverse social factors (for example, no-one able to supervise the injured person at home).
- Continuing concern by the injured person or their carer about the diagnosis. (D)

Transport from community health services and NHS minor injury clinics and pre-hospital management

Transport to the emergency department

Patients referred from community health services and NHS minor injury clinics should be accompanied by a competent adult during transport to the emergency department. (D)

The referring professional should determine if an ambulance is required, based on the patient's clinical condition. If an ambulance is deemed not required, public transport and car are appropriate means of transport providing the patient is accompanied. (D)

The referring professional should inform the destination hospital (by phone) of the impending transfer and in non-emergencies a letter summarising signs and symptoms should be sent with the patient. (D)

Pre-hospital management

The following principles should be adhered to in the immediate care of patients who have sustained a head injury.

Adults who have sustained a head injury should initially be assessed and their care managed according to clear principles and standard practice, as embodied in the Advanced Trauma Life Support (ATLS) course/European Trauma course, International Trauma Life Support (ITLS) course, Pre-hospital Trauma Life Support (PHTLS) course and current JRCALC Clinical Practice Guidelines (2006) for Head Trauma. For children, clear principles are outlined in the Advanced Paediatric Life Support (APLS) / European Paediatric Life Support (EPLS) course, the Pre-hospital Paediatric Life Support (PHPLS) course and the Paediatric Education for Pre-hospital Professionals (PEPP) course materials. [NEW]

Ambulance crews should be fully trained in the use of the adult and paediatric versions of the GCS and its derived score. (D)

Ambulance crews should be trained in the detection of non-accidental injury and should pass information to emergency department personnel when the relevant signs and symptoms arise. (D)

The priority for those administering immediate care is to treat first the greatest threat to life and avoid further harm. (D)

Patients who have sustained a head injury should be transported directly to a facility that has been identified as having the resources necessary to resuscitate, investigate and initially manage any patient with multiple injuries. It is expected that all acute hospitals and all neuroscience units accepting patients directly from the incident will have these resources, and that these resources will be appropriate for the patient's age. [NEW]

Patients who have sustained a head injury and present with any of the following risk factors should have full cervical spine immobilisation attempted unless other factors prevent this:

- GCS less than 15 on initial assessment by the healthcare professional
- neck pain or tenderness
- focal neurological deficit
- paraesthesia in the extremities
- any other clinical suspicion of cervical spine injury [Amended] (D)

Cervical spine immobilisation should be maintained until full risk assessment including clinical assessment (and imaging if deemed necessary) indicates it is safe to remove the immobilisation device. [Amended] (D)

Standby calls to the destination emergency department should be made for all patients with a GCS less than or equal to 8, to ensure appropriately experienced professionals are available for their treatment and to prepare for imaging.(D)

Pain should be managed effectively as it can lead to a rise in intra-cranial pressure. Reassurance and splintage of limb fractures is helpful; catheterisation of a full bladder will reduce irritability. Analgesia as described in 1.4.1.9 should only be given under the direction of a doctor. [New]

Assessment and investigation in the emergency department

Good practice in emergency department assessment

The main focus of emergency department assessment for patients who have sustained a head injury should be the risk of clinically important brain injuries and injuries to the cervical spine and the consequent need for imaging. Due attention should also be paid to co-existing injuries and to other concerns the clinician may have (for example, non-accidental injury, possible non-traumatic aetiology such as seizure). Early imaging, rather than admission and observation for neurological deterioration, will reduce the time to detection of life-threatening complications and is associated with better outcomes.

The priority for all emergency department patients is the stabilisation of airway, breathing and circulation (ABC) before attention to other injuries. (D)

Depressed conscious level should be ascribed to intoxication only after a significant brain injury has been excluded.(D)

All emergency department clinicians involved in the assessment of patients with a head injury should be capable of assessing the presence or absence of the risk factors in the guidance on patient selection and urgency for imaging (head and neck cervical spine – see later recommendations). Training should be available as required to ensure that this is the case. (D)

Patients presenting to the emergency department with impaired consciousness (GCS less than 15) should be assessed immediately by a trained member of staff. (D)

In patients with a GCS less than or equal to 8 there should be early involvement of an anaesthetist or critical care physician to provide appropriate airway management, as described in section 3.6, and to assist with resuscitation. (D)

All patients presenting to an emergency department with a head injury should be assessed by a trained member of staff within a maximum of 15 minutes of arrival at hospital. Part of this assessment should establish whether they are high risk or low risk for clinically important brain injury and/or cervical spine injury, using the guidance on patient selection and urgency for imaging (head and neck cervical spine – see later recommendations). (D)

Patients who, on initial assessment, are considered to be at high risk for clinically important brain injury and/or cervical spine injury should be re-examined fully to establish the need to request CT imaging of the head and/or cervical spine. The guidance on patient selection and urgency for imaging (head and cervical spine) should form the basis for the final decision on imaging after discussion with the radiology department. For recommendations on selection for and urgency of CT imaging of the head see recommendations 3.5.3.1 to 3.5.4.2. For recommendations on imaging of the cervical spine see recommendations 3.5.5.1 to 3.5.7.2 [Amended] (D)

Patients who, on initial assessment, are considered to be at low risk for clinically important brain injury and/or cervical spine injury should be re-examined within a further hour by an emergency department clinician. Part of this assessment should fully establish the need to request CT imaging of the head and/or imaging of the cervical spine. The guidance on

patient selection and urgency for imaging (head and cervical spine) should again form the basis for the final decision on imaging after discussion with the radiology department. See recommendations 3.5.3.1 to 3.5.4.2 (imaging of the head) and 3.5.5.1 to 3.5.7.2 (imaging of the cervical spine). [Amended] (D)

Pain should be managed effectively as it can lead to a rise in intra-cranial pressure. Reassurance and splintage of limb fractures is helpful; catheterisation of a full bladder will reduce irritability. Significant pain should be treated with small doses of intravenous opiates titrated against clinical response and baseline cardiorespiratory measurements. [NEW]

Throughout the hospital episode, all care professionals should use a standard head injury proforma in their documentation when assessing and observing patients with head injury. This form should be of consistent format across all clinical departments and hospitals in which a patient might be treated. A separate proforma for those under 16 years should be used. Areas to allow extra documentation should be included (for example, in cases of non-accidental injury). (Examples of proformas that should be used in patients with head injury are provided in Appendices J, K1 and K2). (D)

It is recommended that in-hospital observation of patients with a head injury, including all emergency department observation, should only be conducted by professionals competent in the assessment of head injury. (D)

Patients who returned to an emergency department within 48 hours of transfer to the community with any persistent complaint relating to the initial head injury should be seen by or discussed with a senior clinician experienced in head injuries, and considered for a CT scan. (B)

Investigations for clinically important brain injuries

The current primary investigation of choice for the detection of acute clinically important brain injuries is CT imaging of the head. (A)

For safety, logistic and resource reasons, MRI scanning is not currently indicated as the primary investigation for clinically important brain injury in patients who have sustained a head injury, although it is recognised that additional information of importance to the patient's prognosis can sometimes be detected using MRI. (D)

MRI is contraindicated in both head and cervical spine investigations unless there is absolute certainty that the patient does not harbour an incompatible device, implant or foreign body. (D)

There should be appropriate equipment for maintaining and monitoring the patient within the MRI environment and all staff involved should be aware of the dangers and necessary precautions for working near an MRI scanner. (D)

Plain X-rays of the skull have no role in the diagnosis of significant brain injury. However, they are useful as part of the skeletal survey in children presenting with suspected non-accidental injury. [NEW]

For patients over 65 presenting out of hours it is acceptable to admit for effective over-night observation and delay the CT scan until the next morning unless indications for an immediate CT scan are present. [NEW]

If CT is unavailable because of equipment failure then patients with a GCS of 15 may be admitted for observation. Arrangements should be in place to transfer them urgently to a

centre with CT scanning available should there be a clinical deterioration that indicates immediate CT scanning is necessary. [NEW]

Skull X-rays in conjunction with high quality in-patient observation also have a role where CT scanning resources are unavailable. (D)

Selection of patients for CT imaging of the head

For adults

Adult patients who have sustained a head injury and present with any one of the following risk factors should have CT scanning of the head requested immediately.

- GCS less than 13 on initial assessment in the emergency department.
- GCS less than 15 at 2 hours after the injury on assessment in the emergency department.
- Suspected open or depressed skull fracture.
- Any sign of basal skull fracture (haemotympanum, 'panda' eyes, cerebrospinal fluid otorrhoea, Battle's sign).
- Post-traumatic seizure.
- Focal neurological deficit.
- More than one episode of vomiting.
- Amnesia for greater than 30 minutes of events before impact. [Amended] (B)

CT should also be requested immediately in patients with any of the following risk factors, provided they have experienced some loss of consciousness or amnesia since the injury:

- Age greater than or equal to 65 years.
- Coagulopathy (history of bleeding, clotting disorder, current treatment with warfarin).
- Dangerous mechanism of injury (a pedestrian or cyclist struck by a motor vehicle, an occupant ejected from a motor vehicle or a fall from a height of greater than 1 metre or five stairs). [Amended] (B)

For children

Children (under 16 years) who have sustained a head injury and present with any one of the following risk factors should have CT scanning of the head requested immediately.

- Loss of consciousness lasting more than 5 minutes (witnessed by a healthcare professional).
- Amnesia (antegrade or retrograde) lasting more than 5 minutes.
- Abnormal drowsiness.
- 3 or more discrete episodes of vomiting.
- Clinical suspicion of non-accidental injury.
- Post-traumatic seizure but no history of epilepsy.
- Glasgow Coma Score (GCS) less than 14, or for a baby under 1 year GCS (paediatric) less than 15, on assessment in the emergency department.
- Suspicion of open or depressed skull injury or tense fontanelle.
- Any sign of basal skull fracture (haemotympanum, 'panda' eyes, cerebrospinal fluid otorrhoea, Battle's sign).
- Focal neurological deficit.

- If under 1 year, presence of bruise, swelling or laceration (more than 5 cm) on the head.
- Dangerous mechanism of injury (high-speed road traffic accident either as pedestrian, cyclist or vehicle occupant, fall from a height of greater than 3 metres, high-speed injury from a projectile or an object). [NEW]

Urgency in performing CT imaging of the head

CT imaging of the head should be performed (that is, imaging carried out and results analysed) within 1 hour of the request having been received by the radiology department in those patients where imaging is requested because of any of the following risk factors.

- GCS less than 13 on initial assessment in the emergency department.
- GCS less than 15 at 2 hours after the injury.
- Suspected open or depressed skull fracture.
- Any sign of basal skull fracture (haemotympanum, 'panda' eyes, cerebrospinal fluid otorrhoea, Battle's sign).
- More than one episode of vomiting in adults. In children more than 3 vomiting episodes (clinical judgement should be used regarding the cause of vomiting in those aged under or equal to 12 years, and whether imaging is necessary).
- Post-traumatic seizure.
- Coagulopathy (history of bleeding, clotting disorder, current treatment with warfarin) providing that some loss of consciousness or amnesia has been experienced. Patients receiving antiplatelet therapy may be at increased risk of intracranial bleeding but this is currently unquantified. Clinical judgement should be used to assess the need for an urgent scan in these patients.
- Focal neurological deficit. [Amended] (B)
- Patients who have any of the following risk factors and none of the risk factors in 3.5.4.1 should have their CT imaging performed within 8 hours of the injury (imaging should be performed immediately in these patients if they present 8 hours or more after their injury).
- Amnesia for greater than 30 minutes of events before impact (the assessment of amnesia will not be possible in pre-verbal children and is unlikely to be possible in any child aged under 5 years).
- Dangerous mechanism of injury (a pedestrian struck by a motor vehicle, an occupant ejected from a motor vehicle or a fall from a height of greater than 1 metre or five stairs) providing that some loss of consciousness or amnesia has been experienced. A lower threshold for height of falls should be used when dealing with infants and young children (that is, aged under 5 years). (B)

Investigation for injuries to the cervical spine

The current initial investigation of choice for the detection of injuries to the cervical spine is the plain radiograph. Three views should be obtained and be of sufficient quality for reliable interpretation. [Amended] (B)

As a minimum, CT should cover any areas of concern or uncertainty on plain film or clinical grounds. (B)

With modern multislice scanners the whole cervical spine can be scanned at high resolution with ease and multiplanar reformatted images generated rapidly. Facilities for multiplanar reformatting and interactive viewing should be available. (B)

MRI is indicated in the presence of neurological signs and symptoms referable to the cervical spine and if there is suspicion of vascular injury (for example, subluxation or displacement of the spinal column, fracture through foramen transversarium or lateral processes, posterior circulation syndromes). (B)

MRI may add important information about soft tissue injuries associated with bony injuries demonstrated by plain films and/or CT. (B)

MRI has a role in the assessment of ligamentous and disc injuries suggested by plain films, CT or clinical findings. (B)

In CT, the occipital condyle region should be routinely reviewed on 'bone windows' for patients who have sustained a head injury. Reconstruction of standard head images onto a high resolution bony algorithm is readily achieved with modern CT scanners.(B)

In patients who have sustained high energy trauma or are showing signs of lower cranial nerve palsy, the results of initial imaging should be considered and particular attention should be paid to the region of the foramen magnum. If necessary, additional high resolution imaging for coronal and sagittal reformatting should be performed while the patient is on the scanner table.(B)

Selection of patients for imaging of the cervical spine

Adult patients with any one of the following risk factors should have three-view radiograph imaging of the cervical spine requested immediately.

- It is considered safe to assess the range of movement in the neck and the patient cannot actively rotate the neck to 45 degrees to the left and right. Safe assessment can be carried out if the patient was involved in a simple rear-end motor vehicle collision, is comfortable in a sitting position in the emergency department, has been ambulatory at any time since injury and there is no midline cervical spine tenderness; or if the patient presents with delayed onset of neck pain.
- It is not considered safe to assess the range of movement in the neck.
- There is neck pain or midline tenderness with:

(a) age greater than or equal to 65 years or

(b) dangerous mechanism of injury (fall from greater than 1 metre or five stairs; axial load to head for example, diving; high-speed motor vehicle collision; rollover motor accident; ejection from a motor vehicle; accident involving motorised recreational vehicles; bicycle collision). A lower threshold for height of falls should be used when dealing with infants and young children (that is, aged under 5 years). [Amended] (A)

Adult patients who have any of the following risk factors should have CT imaging of the cervical spine requested immediately:

- patients with GCS below 13 on initial assessment
- those that have been intubated
- plain film series is technically inadequate (for example, desired view unavailable), suspicious or definitely abnormal

- there is continued clinical suspicion of injury despite a normal X-ray
- a definitive diagnosis of cervical spine injury is required urgently (for example, prior to surgery) and the patient is having other body areas scanned for head injury or multi-region trauma. [NEW]

Children aged 10 years or more can be treated as adults for the purposes of cervical spine imaging. (D)

Children under 10 years should receive anterior/posterior and lateral plain films without an anterior/posterior peg view. (D)

Abnormalities or uncertainties in those under 10 years should be clarified by CT imaging. When minor trauma is associated with subsequent torticollis the plain films are almost uninterpretable; CT imaging is very helpful in this situation. [Amended] (D)

In children under 10 years, because of the increased risks associated with irradiation, particularly to the thyroid gland, and the generally lower risk of significant spinal injury, CT of the cervical spine should only be used in cases where patients have a severe head injury (GCS 8 or less), or where there is a strong clinical suspicion of injury despite normal plain films (for example, focal neurological signs or paraesthesia in the extremities), or cases where there is a strong suspicion of injury and plain films are inadequate. [NEW]

Urgency in performing cervical spine imaging

Imaging of the cervical spine should be performed within 1 hour of a request having been received by the radiology department or when the patient is sufficiently stable. Where a request for urgent head CT (that is, within 1 hour) has also been received, the cervical spine imaging should also be carried out simultaneously. The timing of cervical spine CT in other patients should be dictated by clinical need. [Amended] (D)

Children under 10 years with GCS of 8 or less should have CT imaging of the cervical spine within 1 hour of presentation or when they are sufficiently stable. [NEW]

Investigations of non-accidental injury in children

A clinician with expertise in non-accidental injuries in children should be involved in any suspected case of non-accidental injury in a child under 12 years.

Examinations/investigations that should be considered include: skull X-ray as part of a skeletal survey, ophthalmoscopic examination for retinal haemorrhage, examination for pallor, anaemia, tense fontanelle. Other imaging such as CT and MRI may be required to define injuries. [NEW]

Radiation exposure management

In line with good radiation exposure practice every effort should be made to minimise radiation dose during imaging of the head and cervical spine, while ensuring that image quality and coverage is sufficient to achieve an adequate diagnostic study. (D)

Involving the neurosurgeon

The care of all patients with new, surgically significant abnormalities on imaging should be discussed with a neurosurgeon. The definition of 'surgically significant' should be developed by local neurosurgical centres and agreed with referring hospitals. An example of a neurosurgical referral letter is shown in Appendix L. (D)

Regardless of imaging, other reasons for discussing a patient's care plan with a neurosurgeon include:

- persisting coma (GCS less than or equal to 8) after initial resuscitation.
- unexplained confusion which persists for more than 4 hours
- deterioration in GCS score after admission (greater attention should be paid to motor response deterioration)
- progressive focal neurological signs
- a seizure without full recovery
- definite or suspected penetrating injury
- a cerebrospinal fluid leak. (D)

Admission

The following patients meet the criteria for admission to hospital following a head injury.

- Patients with new, clinically significant abnormalities on imaging.
- Patients who have not returned to GCS equal to 15 after imaging, regardless of the imaging results.
- When a patient fulfils the criteria for CT scanning but this cannot be done within the appropriate period, either because CT is not available or because the patient is not sufficiently co-operative to allow scanning.
- Continuing worrying signs (for example, persistent vomiting, severe headaches) of concern to the clinician.
- Other sources of concern to the clinician (for example, drug or alcohol intoxication, other injuries, shock, suspected non-accidental injury, meningism, cerebrospinal fluid leak). (D)

Some patients may require an extended period in a recovery setting due to the use of general anaesthesia during CT imaging. [Amended] (D)

Patients with multiple injuries should be admitted under the care of the team that is trained to deal with their most severe and urgent problem. (D)

In circumstances where a patient with a head injury requires hospital admission, it is recommended that the patient only be admitted under the care of a Consultant who has been trained in the management of this condition during his/her higher specialist training. The consultant and their team should have competence in assessment, observation and indications for imaging (see recommendations 3.7); indications for transfer to a neuroscience centre (see recommendations 3.6) and hospital discharge and follow up (see recommendations 3.8). [Amended] (D)

It is recommended that in-hospital observation of patients with a head injury should only be conducted by professionals competent in the assessment of head injury. (D)

Transfer from secondary settings to a neuroscience unit

Transfer of adults

Local guidelines on the transfer of patients with head injuries should be drawn up between the referring hospital trusts, the neuroscience unit and the local ambulance service. These should be consistent with established national guidelines and recognise that such transfer is

indicated for all seriously head injured head patients (GCS 8 or less). Details of the transfer of the responsibility for patient care should also be agreed. [Amended] (D)

There should be a designated Consultant in the referring hospital with responsibility for establishing arrangements for the transfer of patients with head injuries to a neuroscience unit and another Consultant at the neuroscience unit with responsibility for establishing arrangements for communication with referring hospitals and for receipt of patients transferred. [Amended] (D)

Patients with head injuries requiring emergency transfer to a neurosciences unit should be accompanied by a doctor with appropriate training and experience in the transfer of patients with acute brain injury. They should be familiar with the pathophysiology of head injury, the drugs and equipment they will use and working in the confines of an ambulance (or helicopter if appropriate). They should have a dedicated and adequately trained assistant. They should be provided with appropriate clothing for the transfer, medical indemnity and personal accident insurance. [Amended] (D)

The transfer team should be provided with a means of communication with their base hospital and the neurosurgical unit during the transfer. A portable phone may be suitable providing it is not used in close proximity (that is, within 1 metre) of medical equipment prone to electrical interference (for example, infusion pumps). (D)

While it is understood that transfer is often urgent, initial resuscitation and stabilisation of the patient should be completed and comprehensive monitoring established before transfer to avoid complications during the journey. A patient persistently hypotensive, despite resuscitation, should not be transported until the cause of the hypotension has been identified and the patient stabilised. [Amended] (D)

All patients with a GCS less than or equal to 8 requiring transfer to a neurosurgical unit should be intubated and ventilated as should any patients with the indications detailed in recommendation 3.6.1.7 and 3.6.1.9. [Amended] (D)

Intubation and ventilation should be used immediately in the following circumstances.

- Coma – not obeying commands, not speaking, not eye opening (that is, GCS less than or equal to 8).
- Loss of protective laryngeal reflexes.
- Ventilatory insufficiency as judged by blood gases: hypoxaemia (less than 13 kPa on oxygen) or hypercarbia (PaCO₂ greater than 6 kPa).
- Spontaneous hyperventilation causing PaCO₂ less than 4 kPa).
- Respiratory arrhythmia [Amended] (D).

Intubation and ventilation should be used before the start of the journey in the following circumstances.

- Significantly deteriorating conscious level (one or more points on the motor score), even if not coma.
- Bilateral mandibular fractures.
- Copious bleeding into mouth (for example, from skull base fracture).
- Seizures. [Amended] (D)

An intubated patient should be ventilated with muscle relaxation and appropriate short acting sedation and analgesia. Aim for a PaO₂ greater than 13kPa, PaCO₂ of 4.5 to 5.0 kPa unless there is clinical or radiological evidence of raised intracranial pressure when more

aggressive hyperventilation is justified to a PaCO₂ of not less than 4 kPa. If hyperventilation is used the inspired oxygen concentration should be increased. The mean arterial pressure should be maintained at 80mmHg or greater by infusion of fluid and vasopressors as indicated. In children the blood pressure should be maintained at a level appropriate for the age of the child. [Amended] (D)

Education, training and audit are crucial to improving standards of transfer; appropriate time and funding for these activities should be provided. (D)

Carers and relatives should have as much access to the patient as is practical during transfer and be fully informed on the reasons for transfer and the transfer process. (D)

A multiply injured adult should not be transferred to a service that is unable to deal with other aspects of trauma. [NEW]

Transfer of children

The recommendations in section 3.6.1 were written for adults but the principles apply equally to children and infants, providing that the paediatric modification of the Glasgow Coma Scale is used. (D)

Service provision in the area of paediatric transfer to tertiary care should also follow the principles outlined in the National Service Framework for Paediatric Intensive Care. These do not conflict with the principles outlined in 3.6.1. (D)

Transfer of a child or infant to a specialist neurosurgical unit should be undertaken by staff experienced in the transfer of critically ill children. (D)

Families should have as much access to their child as is practical during transfer and be fully informed on the reasons for transfer and the transfer process. (D)

A multiply injured child should not be transferred to a service that is unable to deal with other aspects of trauma. [NEW]

Observation of admitted patients

Training in observation

Medical, nursing and other staff caring for patients with head injury admitted for observation should all be capable of performing the observations listed in 3.7.2 and 3.7.5.

The acquisition and maintenance of observation and recording skills require dedicated training and this should be available to all relevant staff.

Specific training is required for the observation of infants and young children. (D)

Minimum documented observations

For patients admitted for head injury observation the minimum acceptable documented neurological observations are: GCS; pupil size and reactivity; limb movements; respiratory rate; heart rate; blood pressure; temperature; blood oxygen saturation. (D)

Frequency of observations

Observations should be performed and recorded on a half-hourly basis until GCS equal to 15 has been achieved. The minimum frequency of observations for patients with GCS equal to 15 should be as follows, starting after the initial assessment in the emergency department:

- half-hourly for 2 hours;
- then one hourly for 4 hours;
- then 2 hourly thereafter.

Should the patient with GCS equal to 15 deteriorate at any time after the initial 2-hour period, observations should revert to half-hourly and follow the original frequency schedule. (D)

Observation of children and infants

Observation of infants and young children (that is, aged under 5 years) is a difficult exercise and therefore should only be performed by units with staff experienced in the observation of infants and young children with a head injury. Infants and young children may be observed in normal paediatric observation settings, as long as staff have the appropriate experience. (D)

Patients changes requiring review while under observation

Any of the following examples of neurological deterioration should prompt urgent reappraisal by the supervising doctor.

- Development of agitation or abnormal behaviour.
- A sustained (that is, for at least 30 minutes) drop of one point in GCS level (greater weight should be given to a drop of one point in the motor score of the GCS).
- Any drop of greater than two points in GCS level regardless of duration or GCS sub-scale.
- Development of severe or increasing headache or persisting vomiting.
- New or evolving neurological symptoms or signs such as pupil inequality or asymmetry of limb or facial movement. (D)

To reduce inter-observer variability and unnecessary referrals, a second member of staff competent to perform observation should confirm deterioration before involving the supervising doctor. This confirmation should be carried out immediately. Where a confirmation cannot be performed immediately (for example, no staff member available to perform the second observation) the supervising doctor should be contacted without the confirmation being performed. (D)

Imaging following confirmed patient deterioration

An immediate CT scan should be considered in patients confirmed as having any of the changes noted in 3.7.5.1 above. (D)

Further imaging if GCS equal to 15 not achieved at 24 hours

In the case of a patient who has had a normal CT-scan but who has not achieved GCS equal to 15 after 24 hours observation, a further CT scan or MRI scanning should be considered and discussed with the radiology department. (D)

Discharge

Discharge and GCS status

No patients presenting with head injury should be transferred to the community until they have achieved GCS equal to 15, or normal consciousness in infants and young children as assessed by the paediatric version of the GCS. (D)

Discharge advice

All patients with any degree of head injury who are deemed safe for appropriate transfer to the community from an emergency department or the observation ward should receive verbal advice and a written head injury advice card. The details of the card should be discussed with the patients and their carers. If necessary (for example, patients with literacy problems, visual impairment or speaking languages without a written format), other formats (for example, tapes) should be used to communicate this information. Communication in languages other than English should also be facilitated. (D)

The risk factors outlined in the card should be the same as those used in the initial community setting to advise patients on emergency department attendance (see Chapter 4). Patients and carers should also be alerted to the possibility that some patients may make a quick recovery, but go on to experience delayed complications. Instructions should be included on contacting community services in the event of delayed complications. (D)

Patients who presented to the emergency department with drug or alcohol intoxication and are now fit for discharge should receive information and advice on alcohol or drug misuse. (D)

Suggested written advice cards for patients and carers are provided in Appendices E, F and G.

Discharge of patients with no carer at home

All patients with any degree of head injury should only be transferred to their home if it is certain that there is somebody suitable at home to supervise the patient. Patients with no carer at home should only be discharged if suitable supervision arrangements have been organised, or when the risk of late complications is deemed negligible. (D)

Discharge of specific patient groups:

Discharge of low risk patients with GCS equal to 15

If CT is not indicated on the basis of history and examination the clinician may conclude that the risk of clinically important brain injury to the patient is low enough to warrant transfer to the community, as long as no other factors that would warrant a hospital admission are present (for example, drug or alcohol intoxication, other injuries, shock, suspected non-accidental injury, meningism, cerebrospinal fluid leak) and there are appropriate support structures for safe transfer to the community and for subsequent care (for example, competent supervision at home). (D)

Discharge of patients with normal imaging of the head

After normal imaging of the head, the clinician may conclude that the risk of clinically important brain injury requiring hospital care is low enough to warrant transfer to the

community, as long as the patient has returned to GCS equal to 15, and no other factors that would warrant a hospital admission are present (for example, drug or alcohol intoxication, other injuries, shock, suspected non-accidental injury, meningism, cerebrospinal fluid leak) and there are appropriate support structures for safe transfer to the community and for subsequent care (for example, competent supervision at home). (D)

Discharge of patients with normal imaging of the cervical spine

After normal imaging of the cervical spine the clinician may conclude that the risk of injury to the cervical spine is low enough to warrant transfer to the community, as long as the patient has returned to GCS equal to 15 and their clinical examination is normal, and no other factors that would warrant a hospital admission are present (for example, drug or alcohol intoxication, other injuries, shock, suspected non-accidental injury, meningism, cerebrospinal fluid leak) and there are appropriate support structures for safe transfer to the community and for subsequent care (for example, competent supervision at home).(D)

Discharge of patients admitted for observation

Patients admitted after a head injury may be transferred to the community after resolution of all significant symptoms and signs providing they have suitable supervision arrangements at home. (D)

Discharge of patients at risk of non-accidental injury

No infants or children presenting with head injuries that require imaging of the head or cervical spine should be transferred to the community until assessed by a clinician experienced in the detection of non-accidental injury. (D)

It is expected that all personnel involved in the assessment of infants and children with head injury should have training in the detection of non-accidental injury. (D)

Outpatient appointments

Every patient who has undergone imaging of their head and/or been admitted to hospital (that is, those initially deemed to be at high risk for clinically important brain injury) should be routinely referred to their General Practitioner for follow-up within a week after discharge. (D)

When a person who has undergone imaging of the head and/or been admitted to hospital experiences persisting problems, there should be an opportunity available for referral from primary care to an out-patient appointment with a professional trained in assessment and management of sequelae of brain injury (for example, clinical psychologist, neurologist, neurosurgeon, specialist in rehabilitation medicine). (D)

Advice about long term problems and support services

All patients and their carers should be made aware of the possibility of long term symptoms and disabilities following head injury and should be made aware of the existence of services that they could contact should they experience long term problems. Details of support services should be included on patient discharge advice cards. [Amended] (D)

Communication with community services

A communication (letter or email) should be generated for all patients who have attended the emergency department with a head injury, and sent to the patient's General Practitioner within one week of the end of the hospital episode. This letter should include details of the clinical history and examination. This letter should be open to the person or their carer, or a copy should be given to them. (D)

A communication (letter or email) should be generated for all children who received head or cervical spine imaging, and sent to the relevant General Practitioner and school nurse for all school aged children within one week of the end of the hospital episode. This letter should include details of the clinical history and examination. [Amended] (D)

A communication (letter or email) should be generated for pre-school children who received head or cervical spine imaging, and sent to the General Practitioner and health visitor within 1 week of the end of the hospital episode. This letter should include details of the clinical history and examination. [Amended] (D)

O.1.10.3 Recommendations for research

The GDG identified the following priority area for research.

The clinical outcome of head injury patients with a reduced level of consciousness improved by direct transport from the scene of injury to a tertiary centre with neurosciences facilities compared with the outcome of those who are transported initially to the nearest hospital without neurosurgical facilities?

The aim of this study is to conduct a comparison in patient outcome (mortality/morbidity) for those head injured patients that are transported directly to a centre with neurosciences facilities with the outcomes of those who are transported to the nearest hospital without neurosciences facilities, possibly necessitating a secondary transfer. Patients suffering from serious head injuries with a reduced level of consciousness are currently transported to the nearest hospital by land ambulance or helicopter. The nearest hospital may not have the resources or expertise to provide definitive care for these patients. Patients should be followed as they pass through the care system with mortality and morbidity outcomes collected. These should be compared to allow, using sub-group analysis, the identification of patients for whom direct transfer is most beneficial.

Why this research is important

Limited evidence in this area has shown that patients do better in terms of outcome if they are transported directly to a neurosciences centre when compared to those who are taken to the nearest DGH. This evidence however does not appear to have influenced current practice. For people working in the prehospital arena, It is important to define which patients who have sustained a head injury would do better by being transported directly to a neurosciences centre.

Currently patients are either always transported to the nearest DGH as is the case in most land vehicle deployment or in some organisations especially those involving helicopter emergency medical services the decision is left to the judgement of the clinicians at the scene. Those patients transported to the nearest DGH may suffer a significant delay in receiving definitive treatment for their head injury. Information from such research can help

to define which patients should be transported direct to a neurosciences centre bypassing the nearest hospital.

Guidance will be required to define the patient population for example, researchers may focus on isolated injuries or head injuries associated with multi trauma. Further specification about what level of consciousness would be suitable for primary transfer to a neurosciences unit would be required. Researchers should look at the impact of the duration of transport on study outcome. So for a journey time to the neurosciences unit of less than 20 minutes, direct transport might improve outcomes, (as concluded by the London Severe Injury Working Group) but beyond this time, direct transport might worsen outcomes.

In addition to measuring changes in morbidity and mortality, the cost-effectiveness of direct transport should be modelled in terms of the cost per quality-adjusted life-year gained. A prototype model was produced for the 2007 update of this guideline (10.6.4).

Research is needed to establish the validity of previously derived clinical decision rules on the selection of head injured infants and children for CT scanning to exclude significant brain injury.

Why this research is important

The 2002 NICE guidelines recommended that children be selected for CT scanning on the basis of the Canadian Head CT rule, a clinical decision rule derived and validated in adults. This was due to the absence of such a rule derived in children. However since this date the CHALICE rule has been published which presents a clinical decision rule derived in a large group of children and infants from the UK with good sensitivity and specificity.

However, clinical decision rules often provide an overestimate of their performance when applied to new populations. We now recommend the usage of the CHALICE rule for children suffering a head injury in the UK, with the caveat that a validation of the rule in a new population of head injured UK patients be urgently undertaken to ensure its reliability and reproducibility.

Such a study is now essential and performing a validation of the CHALICE study in a novel UK population may easily be performed in a 1-2 year timeframe with acceptable costs, and considerable benefits in terms of assuring clinicians as to the safety of this novel rule.

Research is needed to develop consensus on criteria for lesions not currently considered to be surgically significant following imaging of a patient with head injury.

Although most neurosurgeons agree about which extradural and subdural haematomas should be removed, there is controversy about whether or not to remove traumatic intracerebral haemorrhage (TICH) and cerebral contusions (CC). A prospective randomised controlled trial (PRCT) should be set up to discover if early surgery improves the outcome in these lesions compared to initial conservative treatment.

Why this research is important

One option in the management of traumatic intracerebral haemorrhage (TICH) and cerebral contusions (CC) is to monitor the patient clinically or with Intracranial Pressure Monitoring and other forms of brain tissue monitoring such as brain tissue oxygen (BtO₂) or microdialysis. When the patient deteriorates, s/he is rushed to the operating theatre. The problem is that this approach has never been validated in a prospective randomised

controlled trial (PRCT). Waiting until there is deterioration in the level of consciousness (LOC) or until there is deterioration in the monitoring parameters builds delay into the management and results in secondary brain damage occurring and becoming established prior to surgery in all such cases. The principle of early surgical evacuation of spontaneous intracerebral haemorrhage (SICH) has been investigated in the surgical trial in intracerebral haemorrhage (STICH) and reported in the Lancet (2005). The results of such a PRCT in TICH would fundamentally alter the recommendations made by NICE, in terms of which patients should be referred to neurosurgery and, more importantly, how their care should be managed there. There is no level 1 evidence about what to do with these patients and the need for such a PRCT in head injured patients is urgent. This research question should immediately be put to UK research funding bodies.

Do patients with significant traumatic brain injury who do not require operative neurosurgical intervention at presentation, but are still cared for in specialist neurosciences centres, have improved clinical outcomes when compared to similar patients who are treated in non-specialist centres?

Why this research is important

Traumatic brain injury (TBI) is amongst the most important causes of death in young adults, with an overall mortality for severe TBI of over 50%. TBI care consumes one million acute hospital bed-days, and over 15,000 ICU bed-days annually, and patients who do survive significant TBI experience an enormous burden of long term physical disability, neurocognitive deficits, and neuropsychiatric sequelae. The financial impact is significant: the NHS spends over £1 billion on just the acute hospital care of the 10,000 patients with significant TBI. The costs of rehabilitation and community care are difficult to estimate, but probably total many multiples of the figure provided for acute care. These considerations make TBI a national healthcare priority and its outcome impact is consistent with its inclusion in the National Service Framework for Long Term Neurological Conditions.

Current referral of patients with acute traumatic brain injury practice is still dominated in many parts of the United Kingdom by the need for operative neurosurgical intervention at presentation. This may be inappropriate, since many patients with severe head injury have evidence of raised intracranial pressure in the absence of surgical lesions, and suffer morbidity and mortality equal to those with surgical lesions. Further, several studies provide strong circumstantial evidence that managing such “non-surgical” patients in specialist neurosciences centres may result in substantial improvements in mortality and functional outcome, probably due to specialist expertise in areas of non-operative management, such as neurocritical care. However, these results may be confounded by case-mix effects and referral bias, and the cost-effectiveness of such specialist management remains uncertain. There is a strong case to address this question in the context of a formal study, since a change in practice could have a major impact on death and disability in a condition that is a major contributor to mortality in healthy young adults. Importantly, the results of such a study could fundamentally alter the recommendations made by NICE, in terms of where patients with head injury are treated within the healthcare system, and result in better optimised (and potentially more cost-effective) patient flows within the NHS.

The available evidence in this area has been addressed in the systematic review that contributed to the revision of NICE Guidelines on the early management of head injury. This review could find no high quality clinical evidence on the topic. This is unsurprising, since any study that addressed these issues would have to be undertaken within the context of a healthcare system and include ambulance services, district general hospitals and

neuroscience referral centres. Such a study would therefore require the organisational backing of a body such as NICE, and careful design to account for confounds and biases. However, we believe that given careful design, such a study would be both ethically and logistically feasible. The patient group is well defined, and adequate numbers would be available to provide a definitive result within a reasonable time frame. While circumstantial evidence may support transfer of such patients to neurosciences centres, current practice is not influenced by this view in many regions, and many would argue that there is still clinical equipoise in this area. There are clear risks from transfer, and there could be clear harm, both in terms of clinical outcome and health economics, if the anticipated benefits were not realised. On the other hand, if the benefits from observational studies were confirmed by the trial, the resulting changes in management that could potentially reduce case-mix adjusted mortality by 26% and increase the incidence of favourable outcome in survivors by nearly 20%.

Research is needed to summarise and identify the optimal predictor variables for long term sequelae following mild traumatic brain injury.

A systematic review of the literature could be used to derive a clinical decision rule to identify, at the time of injury, relevant patients. This would in turn lay the foundation for a derivation cohort study.

Why this research is important

We performed a review of the literature in this area, repeated in this update process. While 394 studies were identified that attempted to use a wide range of variables and tests to predict a range of longer term outcome measures, no robust clinical decision tools has successfully been derived and validated to identify patients at the time of injury who could be considered for follow-up due to a higher risk of long term sequelae. A systematic review of the literature would summarise and identify the optimal predictor variables for such a clinical decision rule and also identify the optimal outcome variables, thus laying the foundation for a derivation cohort study.

The derivation cohort study to create this clinical decision rule could potentially be conducted in conjunction with the validation of the CHALICE rule, with follow up of patients involved in this study at 6mths-1yr. This would ensure optimal value for money for funders and ensure good results in a large cohort of patients. Separate studies could also be performed in adults but the initial study may in fact be more urgent in the childhood population.

Identification of patients likely to suffer from long term sequelae will allow targeted research regarding responsiveness to, or effectiveness of focused rehabilitation programmes. Preventative action could potentially be taken, thus reducing the strain on resources further down the care pathway. Furthermore, patient outcomes could potentially be improved by early identification and treatment (both curative and preventive) of problems. However, further research is required before we can be certain that a robust framework exists with which to cope with individuals identified by the clinical prediction rule proposed above.

Pre-hospital assessment, advice and referral to hospital

Is the clinical outcome of head injury patients with a reduced level of consciousness improved by direct transport from the scene of injury to a tertiary centre with

neurosciences facilities compared with the outcome of those who are transported initially to the nearest hospital without neurosurgical facilities?

The aim of this study is to conduct a comparison of patient outcomes (mortality/morbidity) for those head injured patients that are transported directly to a centre with neurosciences facilities with the outcomes of those who are transported to the nearest hospital without neurosciences facilities, possibly necessitating a secondary transfer. Patients suffering from serious head injuries with a reduced level of consciousness are currently transported to the nearest hospital by land ambulance or helicopter. The nearest hospital may not have the resources or expertise to provide definitive care for these patients. Patients should be followed as they pass through the care system with mortality and morbidity outcomes collected. These should be compared to allow, using sub-group analysis, the identification of patients for whom direct transfer is most beneficial.

Why this research is important

Limited evidence in this area has shown that patients do better in terms of outcome if they are transported directly to a neurosciences centre when compared to those who are taken to the nearest DGH. This evidence however does not appear to have influenced current practice. For people working in the prehospital arena. It is important to define which patients who have sustained a head injury would do better by being transported directly to a neurosciences centre.

Currently patients are either always transported to the nearest DGH as is the case in most land vehicle deployment or in some organisations especially those involving helicopter emergency medical services the decision is left to the judgement of the clinicians at the scene. Those patients transported to the nearest DGH may suffer a significant delay in receiving definitive treatment for their head injury. Information from such research can help to define which patients should be transported direct to a neurosciences centre bypassing the nearest hospital.

Guidance will be required to define the patient population for example, researchers may focus on isolated injuries or head injuries associated with multi trauma. Further specification about what level of consciousness would be suitable for primary transfer to a neurosciences unit would be required. Researchers should look at the impact of the duration of transport on study outcome. So for a journey time to the neurosciences unit of less than 20 minutes, direct transport might improve outcomes, (as concluded by the London Severe Injury Working Group) but beyond this time, direct transport might worsen outcomes.

O.1.11 Assessment in the emergency department

O.1.11.1 The best clinical prediction rule for selecting adults, infants and children with head injury for CT imaging of the head (2007)

Introduction and rationale for the clinical question

In order to improve the efficiency of the management of minor head injury, clinical prediction rules can be applied. A clinical prediction rule is derived from original research and is defined as a decision making tool that incorporates 3 or more variables from the history, examination or simple tests^{493,496,497}. This review was carried out to examine which clinical prediction rule was the best for selecting patients for CT imaging who had experienced a minor head injury. This question was deemed important as the current use of CT for minor head injury is increasing rapidly; it is highly variable and may be inefficient. The

interventions included within this review were any prediction rule ranging from NEXUS, NOC, CHR and any other new rules. The studies were included if the outcomes included sensitivity and specificity of prediction rules.

Clinical evidence

In the previous guideline, four studies discussed decision rules for selecting patients for CT imaging which attempted to identify those at a high risk for traumatic brain injury (usually ICH).^{194,309,416,497} On examination of these studies it was felt that one study had validated the rules in a population with a much lower prevalence of abnormal CT scans than an average UK population^{416,416} and this study was not considered. A second study described a rule that had only a 65% sensitivity for abnormal CT scan results and was also not considered further.^{309,310} The sensitivity of these rules have been questioned in another study.^{217,217}

The remaining two sets of rules, the Canadian CT-rules^{497,498} and the 'New Orleans' criteria are now considered.^{194,194} Two versions of the Canadian rules are available, a five point version designed to detect 'need for neurological intervention', and a seven point version designed to detect 'clinically important brain injury'. The remit of this guideline is on the latter outcome, and the seven point rule is therefore the focus of this review. However, it is recognised that the five point rule has some utility in determining the urgency with which CT imaging should be performed.

Both papers present high quality evidence, but strictly the New Orleans criteria represents level one evidence as it has used separate samples for the derivation and validation phases. The Canadian rules represent level two evidence as they have not yet been validated in a separate sample (this study is ongoing and will report in 2003). Both sets of authors caution against adoption of their rules, the Canadians because of the need for validation, and the New Orleans group because their rules were developed in one centre (the Canadian rules were developed in a multi-centre study).

The Canadian sample^{497,498} for a derivation sample, was much larger with 3,121 patients than the New Orleans sample^{194,194} with 520 patients in the derivation phase and 909 patients in the validation phase. This led to statistical power problems with certain key variables (for example, coagulopathy) as not enough patients with these risk factors experienced a negative outcome. It should be noted that the Canadian study considered a much broader range of possible predictive variables, and has outlined in great detail the steps taken to ensure the validity and reliability of the data. Both studies used recursive partitioning as the multivariate technique used to derive the rules.

Both studies excluded patients who had experienced no loss of consciousness. The New Orleans study reports an overall abnormal CT rate of 6.5% and a surgical intervention rate of 0.4%, while the Canadian study reports a rate of clinically important brain injury of 8% and a neurosurgical intervention rate of 1%. The Canadian study included only patients with an initial GCS on arrival at hospital of 13 to 15 and assumed that all patients with GCS less than 13 would receive immediate CT. Four per cent of patients in this study had an initial GCS of 13 and 17% had a GCS of 14, with the remaining 79% having a GCS of 15. The New Orleans study focused on patients with GCS equal to 15 in the emergency department (assuming that all patients with GCS less than 15 would receive immediate CT) and therefore had a lower severity sample than was seen in the Canadian sample.

The cohort used for the derivation of the Canadian Head CT rule contained 69% males, 11% greater than or equal to 65 years and 31% patients who had sustained a fall, similar to figures for the UK. However, as noted in section 1.8: cause of injury, the proportion of

assaults seen in the Canadian sample (11%) is lower than is usually quoted for the UK (30-50%). By contrast, the proportion of road traffic accidents in the Canadian sample (43% if injuries involving pedestrians and cyclists are included) is higher than estimates of 25% for the UK. It is not clear whether this reflects broad difference in injury patterns between the two countries, or simply reflects the specific group of patients selected for the Canadian study (that is, hospital attendees that had experienced some loss of consciousness or amnesia).

It is also important to note that the Guideline Development Group is under the impression that head injury episodes are more likely to involve alcohol in the UK than in Canada, although exact data on this variable is not available.

Both studies report 100% sensitivity (95% CI: 92-100) for need for neurosurgical intervention. The New Orleans criteria reports a 100% (95% CI: 95-100) sensitivity for positive CT scans, whereas the Canadian seven point rules are 98% (95% CI: 96-99) sensitive for detecting clinically important brain injury. The New Orleans rules have a 25% (95% CI: 22-28) specificity for detecting positive CT scans whereas the Canadian rules are reported to have a 50% (95% CI: 48-51) specificity rate for detecting clinically important brain injury.

The New Orleans criteria would lead to a 78% CT ordering rate in patients with GCS equal to 15. The Canadian seven point rules would lead to a 54% ordering rate in patients with a GCS of 13 to 15. It is important to note that the New Orleans study reports 100% CT-scanning of the sample, whereas the Canadian study had a scanning rate of only 67%, and the remaining 33% had a proxy outcome assessment via telephone interview. The final sample in the Canadian study does not include some 10% of eligible patients who did not undergo CT and subsequently could not be contacted for follow-up.

The rules have the following similarities. Both suggest that patients with GCS less than 15 on presentation at emergency departments should have immediate CT imaging. The only caveat to this is that the Canadian rules specify GCS less than 15 two hours after injury. However, it should be born in mind that 93% of adults and 96% of children report to emergency departments with GCS equal to 15,^{507,508} implying that CT imaging for those with GCS less than 15 will not greatly impact on resources. The area of controversy is generally accepted to relate to patients with GCS equal to 15.

Neither rule suggests a role for skull X-ray or admission for observation without CT imaging. Both rules agree that vomiting should be included as an indication for imaging, although the Canadian rule specifies more than one episode. Both rules agree that skull fracture (linear, basal, depressed, open, depressed and penetrating) should be an indication for CT imaging but these are defined and dealt with in different ways. In the New Orleans rules this is included as part of a category named 'physical evidence of trauma above the clavicles' which also includes contusions, abrasions and lacerations. Presumably these would include facial surface wounds and not only wounds to the skull. The Canadian rules seem to have considered obvious penetrating skull injury and/or obvious depressed skull fracture as a priori indications for imaging and have also included any sign of basal skull fracture, and any 'suspicion' of open or depressed skull fracture as part of their rules.

Both rules include an age category. The New Orleans rules specify age greater than 60 years, and the Canadian rules specify age greater than or equal to 65 years.

Both rules agree that post-traumatic seizure should be an indication for CT imaging, but the Canadian rules considered this an a priori variable, whereas it is explicitly included in the New Orleans rules.

It is also important to note that coagulopathy is not included in either set of rules but for very different reasons. The Canadian study excluded these patients deliberately, presumably because they were considered a priori candidates for CT imaging. The New Orleans rules included these patients but did not have enough power to detect a significant predictive effect. The New Orleans study explicitly states that this variable was not considered by their study and imply that it should be considered an important predictive variable. A further exclusion from both samples is focal neurological deficit (this is not completely clear from the New Orleans study) again, presumably because CT imaging of the head for these patients was considered non-controversial.

The rules differ in their treatment of amnesia. The Canadian rules include pre-traumatic amnesia (retrograde – for events before the injury) of greater than 30 minutes, whereas the New Orleans rules include post-traumatic ‘short-term memory deficits’ (anterograde - for events after the injury). The Canadian rules contain a variable called ‘dangerous mechanism’ (of injury), which is defined as a pedestrian struck by a motor vehicle, an occupant ejected from a motor vehicle or a fall from a height of greater than three feet or five stairs. The New Orleans rules did not consider this variable. The New Orleans rules contain a headache variable, which was dropped from the Canadian rules.

The New Orleans rules contain a variable for drug or alcohol intoxication whereas this is not included in the Canadian rules. The Canadian authors seem to imply that having a variable "GCS less than 15 after 2 hours" will allow the less severe intoxications to resolve and eliminate a corresponding number of unnecessary scans. The Canadian authors measured ethanol levels in a sub-sample and found that it had no predictive power for the outcomes studied.

UPDATE 2007: Adult rules

Three new studies^{327,472,493} were retrieved for this review looking at clinical prediction rules in adults in addition to the studies in the previous guideline (see above).

One of the 3 new studies looking at clinical prediction rules in adults was Stiell et al^{493,498}, a prospective cohort validation study (diagnostic study level I evidence) of 1822 blunt head trauma patients in nine Canadian emergency departments. In the previous guideline the derivation study was included. The inclusion criteria were defined as blunt trauma to the head resulting in the witnessed loss of consciousness, definite amnesia or witnessed disorientation, GCS score of 13 or greater and injury within the previous 24 hours. The Canadian CT head rule (CCHR) was compared to the New Orleans Criteria (NOC). There were 97 patients (5.3%) with clinically important brain injury and 8 patients (0.4%) required neurosurgical intervention. For the outcome clinically important brain injury both rules had 100% (95% CI, 96% to 100%) sensitivity. But the Canadian CT head rule had a higher specificity of 50.6% (95% CI, 48% to 53%) than NOC 12.7% (95% CI, 11% to 14%). The reference standard was the CT scan.

The second study was a prospective cohort study (diagnostic study level II evidence) by Smits et al^{472,472} which included 3181 Dutch patients with blunt head injury compared the NOC and CCHR rules. The inclusion criteria were patients older than 16 years, GCS of 13 to 14 and presenting within 24 hours. Patients with a GCS score of 15 were included with one of the following risk factors; history of loss of consciousness, short-term memory deficit, amnesia for traumatic event, posttraumatic seizure, vomiting, severe headache, clinical evidence of intoxication, use of anticoagulants, physical evidence of injury above clavicles or neurological deficit.

The prevalence of neurocranial traumatic CT finding was 9.8% and the incidence of neurosurgical intervention was 0.5%. The CT scan was used as the reference standard. For neurosurgical intervention both rules had 100% (95% CI, 81.6 to 100%) sensitivity and the CCHR had a higher specificity of 37.5% (95% CI, 34.9% to 40.0%) compared to NOC 3.0% (95% CI, 1.2% to 4.8%). Neurocranial traumatic CT findings and important CT findings reported a higher sensitivity for the NOC rule. Outcomes were also reported on the entire population, which resulted in the authors adapting the rules to their study population. This study has methodological concerns as the rules tested were adapted to fit into their study population.

The final study^{327,329} was a prospective cohort derivation study (diagnostic study level II evidence) for the NEXUS II rules by Mower et al which has not yet been validated in a separate sample. This study comprised of 13,728 blunt trauma patients that had undergone head CT scan in 21 participating centres. The prevalence of intracranial injury was 6.7% (917 out of 13,728). The prediction rule had 8 criteria highly associated with intracranial injuries. The rule had a sensitivity of 98.3% (95% CI, 97.2% to 99.0%) and specificity of 13.7% (95% CI, 13.1% to 14.3%).

UPDATE 2007: Child rules

Four new studies in children^{117,195,364,375} were retrieved in this update.

One of the 4 new studies, Oman et al,^{364,364} a prospective cohort study (diagnostic study level II evidence) looked at clinical prediction rules in children which included 1666 children (under 18 years) with blunt head trauma. Patients underwent CT scanning from 21 emergency departments in the NEXUS cohort. This study looked at children in the NEXUS II derivation study to determine if the prediction rule was effective on children. The prevalence of clinically important ICI was 8.3%. The sensitivity was 98.6% (95% CI, 94.9-99.8) and the specificity was 15.1% (95% CI, 13.3-16.9). When the sub-group of children under 3 years old was examined the sensitivity was 100% (95% CI, 86.3-100).

The second prospective cohort study (diagnostic study level I evidence) by Haydel et al^{194,195} comprised of 175 children (5-17 years) with minor head injury from trauma centre in US. Minor head injury was defined as blunt head trauma with loss of consciousness with a normal GCS score, or modified coma scale for infants and children and normal brief neurological examination. The reference standard was the CT scan. The NOC prediction rule was applied to the population to determine children with intracranial injury. The prevalence was 8%. The sensitivity was 100% (95% CI, 73-100) and the specificity was 25.5% (95% CI, 19.1-33.0%). The CT ordering rate was reduced by 23.4% (95% CI, 17.7-30.2).

Palchak^{375,375} reported a prospective cohort study (diagnostic study level II evidence) of 2,043 children (under 18 years) presenting with blunt head trauma (all severities) at a paediatric emergency department of level 1 trauma centre. Significant predictors of traumatic brain injury were determined and the prediction rule was derived using recursive partitioning. The reference standard was CT scanning and clinical follow-up. The prediction rule had a sensitivity of 100% (95% CI, 97.2% to 100%) and a specificity of 42.7% (95% CI, 40.5% to 44.9%) to identify traumatic brain injury requiring intervention. The prediction rule was used on the sub-group of patients that had a CT scan (n=1271) to identify traumatic brain injury identified on CT. The sensitivity was 99.0% (95% CI 94.4% to 100%) and specificity of 25.8% (95% CI 23.3% to 28.4%). One patient was missed using this prediction rule that had a positive traumatic brain injury identified on CT. This is a derivation study and has not yet been validated.

Palchak prediction rule:

A CT scan is required if any of the following predictors are present:

- Abnormal mental status
- Clinical signs of skull fracture
- History of vomiting
- Scalp hematoma in children aged 2 years or younger
- Headache

The final study by Dunning^{117,119} which is a prospective multi-centre cohort (diagnostic study level II evidence) reported 22,772 children (under 16 years) presenting at ten hospital emergency departments in the North West of England with any severity of head injury. Significant predictors of intracranial haemorrhage were determined and the Children's Head Injury Algorithm to predict Important Clinical Events (CHALICE) prediction rule was derived using recursive partitioning. The reference standard was CT scanning and clinical follow-up by a multi-modal method of patient monitoring. The CHALICE prediction rule had a sensitivity of 98.6% (95% CI, 96.4% to 99.6%) and a specificity of 86.9% (95% CI, 86.5% to 87.4%). The CT scan ordering rate was 14%. This is a derivation study and has not yet been validated.

The CHALICE Prediction Rule:

A computed tomography scan is required if any of the following criteria are present.

History

- Witnessed loss of consciousness of more than 5 min duration
- History of amnesia (either antegrade or retrograde) of more than 5 min duration
- Abnormal drowsiness (defined as drowsiness in excess of that expected by the examining clinician)
- 3 or more vomits after head injury (a vomit is defined as a single discrete episode of vomiting)
- Suspicion of non-accidental injury (NAI, defined as any suspicion of NAI by the examining clinician)
- Seizure after head injury in a patient who has no history of epilepsy

Examination

- Glasgow Coma Score (GCS) less than 14, or GCS less than 15 if less than year old
- Suspicion of penetrating or depressed skull injury or tense fontanelle
- Signs of a basal skull fracture (defined as evidence of blood or cerebrospinal fluid from ear or nose, panda eyes, Battle's sign, haemotympanum, facial crepitus or serious facial injury)
- Positive focal neurology (defined as any focal neurology, including motor, sensory, coordination or reflex abnormality)
- Presence of bruise, swelling or laceration more than 5 cm if less than 1 year old

Mechanism

- High-speed road traffic accident either as pedestrian, cyclist or occupant (defined as accident with speed more than 40 m/h)
- Fall of more than 3 m in height

- High-speed injury from a projectile or an object

If none of the above variables are present, the patient is at low risk of intracranial pathology.

Economics Evidence from 2007 update

See economic section chapter 13.

Summary of evidence from 2007 update

Adult Rule

Three new studies^{327,472,493} were identified for this review which compared different decision rules in adults. One study^{493,498} showed that for patients with minor head injury and GCS score of 15, the Canadian CT head rule had a higher specificity than NOC for clinical important outcomes. This study also showed that the Canadian CT head rule and NOC have equivalent high sensitivities for detecting the need for neurosurgical intervention and clinically important brain injury. The second study^{472,472} showed for patients with minor head injury and a GCS score of 13 to 15, the Canadian CT head rule has a lower sensitivity than the NOC for neurocranial traumatic or clinically important CT findings. The final study^{327,329} included the NEXUS II rule which had a sensitivity of 98.3% and specificity of 13.7%.

When we updated the unit costs in the guideline's cost analysis, the results were even more favourable towards the Canadian head CT rule, since radiology costs had fallen. Two studies^{192,467} of the impact of our recommendation for head imaging showed opposite results; there is still great uncertainty about the rates of imaging and admission nationally and therefore the overall economic impact of the guideline is unclear. A published economic evaluation^{485,488} using cohort study evidence suggested that the Canadian head CT rule is more cost-effective in a US context than a number of alternative strategies based on CT, X-ray or admission. However, none of the economic evidence has taken into account the impact of the increased radiation exposure.

Child Rules

The 4 new studies^{117,195,364,375} within this review compared different decision rules in children. One study^{364,364} concluded that the decision rule derived in the large NEXUS II cohort performed with similar high sensitivity among the subgroup of children who were included in this study. The second study^{194,195} found that CT use in children aged 5 years or older with minor head injury could be safely reduced by 23% by using a clinical decision rule previously validated in adults. The Palchak study^{375,375} derived a clinical decision rule for the identification of children who should undergo CT after head injury. The final study^{117,119} derived a highly sensitive clinical decision rule for the identification of children who should undergo CT scanning after head injury.

We did not find any economic evidence specific to children.

Rationale behind recommendation

Two evidence based decision rules for selection of patients who have sustained a head injury for CT imaging of the head have been described. There is no clear means of choosing one over the other, and the decision on which rule to choose was therefore based on consensus. Based on the Guideline Development Group consensus, it was decided that the seven point

Canadian CT head rules should be used to identify patients who will need CT imaging of the head.

In order to provide guidance that covers all possibilities, the seven point Canadian CT rule has been slightly adapted as follows.

- Patients with post-traumatic seizure, focal neurological deficit or coagulopathy should be included in the rule.
- Patients with non-symptomatic risk factors (that is, age greater than or equal to 65 years, coagulopathy, dangerous mechanism of injury) should at least have had an instance of loss of consciousness or amnesia (that is, the main signs and symptoms used to screen patients for inclusion in the Canadian CT-head rule study) before receiving CT. This is to prevent the possibility of patients with no signs or symptoms receiving a CT.
- As noted above, falls from three feet have been changed to falls from greater than 1 metre, to ensure consistency with other rules adopted by this guideline. A lower threshold for height of falls should be used when dealing with infants and young children (that is, aged under 5 years). See section 4.8.
- Clinical judgement regarding the cause of vomiting in those aged under or equal to 12 years should be used, and this judgement should guide whether imaging is considered necessary.
- The assessment of amnesia will not be possible in pre-verbal children and is unlikely to be possible in any child aged under 5 years.

The 2003 Guideline Development Group considered these recommendations see below (not highlighted in grey) to be interim and dependant on future research which was likely to appear in the literature in time for the update. These include the validation phase of the Canadian CT head rules, and a new clinical decision instrument based upon the NEXUS II study. The latter study recruited approximately 15,000 patients to the overall project (derivation and validation)^{326,329}.

In relation to selection of patients for imaging of the head, a recent level two study has produced a clinical decision rule for use in children aged under 2 years. It is likely that a validation study for this rule will appear in the near future, although methodological concerns will remain about the derivation phase (see Appendix i). A strong predictive power is ascribed to scalp haematoma in young children.^{171,172}

The literature on skull X-ray in children and infants indicates that, as with adults, the specificity of skull X-ray is too low to be the primary investigation (that is, the absence of skull fracture does not predict absence of intra-cranial complications).^{171,279,531} In studies which have included both children and adults, there is evidence that adult rules can be safely applied to children, but these studies have suffered from statistical power problems.⁵²⁷ The evidence regarding the safety of adult rules with infants is inconclusive.^{194,309,416}

UPDATE 2007: Adult rules

Based on the three adult prediction rule studies^{327,472,493}, the GDG decided that no change in recommendation was required as they felt there was not enough evidence to warrant a change. The case for selective CT scanning was strengthened by a cost-effectiveness model, although it was conducted from a US perspective and the UK evidence showed great variability between centres. One study had drawn attention to difficulties in scanning and discharging patients out of hours^{191,192}, in particular, it is often not practical to discharge elderly patients during the night for social reasons. The GDG agreed that for patients presenting out of hours it is safe to admit fully conscious patients (GCS 15/15) over the age

of 65 years for over-night observation when they would otherwise warrant an immediate CT. Admitting these patients over night could be lower cost than out of hours CT scanning, especially as it won't be possible to discharge many of these patients. Furthermore the Af Geijerstam study showed that for head injured patients generally, observation was not associated with a significant increase in morbidity or mortality compared with immediate CT (see 6.4). The GDG also recognize that any centre which receives head injured patients should have a CT scan within 24 hours however there may be situations where due to failure of CT scanning equipment this may not be possible. It is then important to make sure that patients are transfer to a centre which does have the relevant equipment (see recommendation 6.5.6).

UPDATE 2007: Child rules

The original recommendation stated that validated adult rules (Canadian head CT rule) on imaging of the head may be safely used in children and infants. However, the GDG decided that a new recommendation was required for clinical prediction rules of the head in children with the emerging evidence in the Dunning study in this update (CHALICE)^{117,119}.

The CT ordering rates for both rules are similar^{117,119} and therefore the rule that is most accurate is likely to be the most cost-effective.

The GDG considers the recommendation of CHALICE rule for children currently represents the best evidence for the treatment of head injuries in children, but the GDG cautions that this rule is a derivation study only and requires prospective validation. Therefore future recommendations will be dependent on future validation studies.

O.1.11.2 Recommendations

For Adults-

1. Adult patients who have sustained a head injury and present with any one of the following risk factors should have CT scanning of the head requested immediately.

- GCS less than 13 on initial assessment in the emergency department.
- GCS less than 15 at 2 hours after the injury on assessment in the emergency department.
- Suspected open or depressed skull fracture.
- Any sign of basal skull fracture (haemotympanum, 'panda' eyes, cerebrospinal fluid otorrhoea, Battle's sign).
- Post-traumatic seizure.
- Focal neurological deficit.
- More than one episode of vomiting.
- Amnesia for greater than 30 minutes of events before impact. [2003, amended 2007]

2. CT should also be requested immediately in patients with any of the following risk factors, provided they have experienced some loss of consciousness or amnesia since the injury.

- Age greater than or equal to 65 years.
- Coagulopathy (history of bleeding, clotting disorder, current treatment with warfarin).
- Dangerous mechanism of injury (a pedestrian or cyclist struck by a motor vehicle, an occupant ejected from a motor vehicle or a fall from a height of greater than 1 metre or five stairs). [2003]

These recommendations are based on level two evidence and are considered to be grade B recommendations.

For Children

3. Children (under 16 years) who have sustained a head injury and present with any one of the following risk factors should have CT scanning of the head requested immediately.

- Loss of consciousness lasting more than 5 minutes (witnessed by a healthcare professional).
- Amnesia (antegrade or retrograde) lasting more than 5 minutes.
- Abnormal drowsiness.
- 3 or more discrete episodes of vomiting.
- Clinical suspicion of non-accidental injury.
- Post-traumatic seizure but no history of epilepsy.
- Glasgow Coma Score (GCS) less than 14, or for a baby under 1 year GCS (paediatric) less than 15, on assessment in the emergency department
- Suspicion of open or depressed skull injury or tense fontanelle.
- Any sign of basal skull fracture (haemotympanum, 'panda' eyes, cerebrospinal fluid otorrhoea, Battle's sign)
- Focal neurological deficit
- If under 1 year, presence of bruise, swelling or laceration (more than 5 cm) on the head
- Dangerous mechanism of injury (high-speed road traffic accident either as pedestrian, cyclist or vehicle occupant, fall from a height of greater than 3 metres, high-speed injury from a projectile or an object). [2007]

O.1.11.3 The best clinical prediction rule for selecting patients that have sustained damage to the cervical spine for the imaging technique selected in section 6.7? (2007)

Introduction and rationale for the clinical question

In order to improve the efficiency of the management of cervical spine injury, clinical prediction rules can be applied. A clinical prediction rule is derived from original research and is defined as a decisional making tool that incorporates three or more variables from the history, examination or simple tests^{493,496,497}. This review was carried out to examine which clinical prediction rule was the best for determining which patients should undergo CT of the cervical spine. This question was deemed important as emerging evidence shows that the current practice of using plain films is not always reliable in identifying clinically important injuries to the cervical spine. This is particularly true in patients with severe head injury in whom assessment is more difficult. The interventions included within the studies were any prediction rule ranging from NEXUS, NOC, CCR and any other new rules. The outcomes included sensitivity and specificity of prediction rules.

Clinical evidence (2003)

In the 2003 guideline, a systematic review of clinical decision rules for selection of patients who sustained a head injury for imaging of the cervical spine was carried out according to the methods outlined in Chapter Two. Two level one studies were identified.^{208,499} These were the NEXUS study group from America and the Canadian cervical spine rule.

The remaining papers that were reviewed all contained non-level one evidence for a variety of rules and were derived in small cohorts. In addition some papers considered a variety of different aspects of cervical spine imaging. These included studies in patients who are not fully conscious, studies on the utility of flexion-extension views, studies in children and studies on the utility of CT scanning or MRI scanning. These studies are included in the evidence table but contribute little to the decision as to which rule to use to exclude low risk patients from cervical imaging.

The Canadian cervical spine rule involves the following questions.

- Is there any high risk factor present that mandates radiography: age greater than or equal to 65 years, dangerous mechanism, or paraesthesia in the extremities?
- Is there a low risk factor present that allows the safe assessment of range of motion (that is, simple rear-end motor vehicle collision, sitting position in ED, ambulatory at any time since injury, delayed onset of neck pain, absence of midline cervical spine tenderness?)
- Is the patient able to actively rotate their neck 45 degrees to the left and right?

For the NEXUS rule, absence of five criteria are used to classify the patient as low risk.

- No midline cervical tenderness.
- No focal neurological deficit.
- Normal alertness.
- No intoxication.
- No painful distracting injury.

Both papers present high quality evidence, the NEXUS rule is level one evidence although they validated their rule by asking each doctor whether the patient was high or low risk using the rule rather than compelling the attending physician to follow the rule. The validation phase of the Canadian cervical spine rules has now been completed and successfully validates the rule.

The NEXUS study²⁰⁸ collected prospective data on 34,069 patients in twenty-one hospitals in the USA who underwent cervical imaging following blunt trauma. Included were patients at all levels of alertness, and children. The Canadian cervical spine rule studied 8,924 patients in ten large Canadian community and university hospitals who underwent cervical imaging following blunt trauma. Only adults with a GCS score equal to 15 were included.

The Canadian cervical spine rule excluded patients who were not fully alert at the time of assessment (that is, GCS equal to 15) on the assumption that these patients would automatically receive cervical spine imaging. The NEXUS rule included all levels of alertness. The NEXUS paper reports an overall cervical fracture rate of 2.4% and a clinically significant fracture rate of 1.7%, while the Canadian paper reports an overall fracture rate of 2.0% with a clinically significant cervical spine fracture rate of 1.7%. The NEXUS rule had no age exclusion whereas the Canadian rules were derived and validated only on patients aged over 16 years.

The Canadian cervical spine rule gives a sensitivity of 100% (95% CI: 98-100) and NEXUS gives a sensitivity of 99.6% (95% CI: 98.6-100). The NEXUS rule is not 100% sensitive but of the two clinically significant missed fractures one had an extension-teardrop fracture and self discharged. He was well at six months. One had a fracture of the right lamina of the sixth cervical vertebra requiring open fixation, but may have been incorrectly classified as low risk by the institution as he had loss of consciousness and neurological signs. Of interest, Stiell et al tested the NEXUS rule on the Canadian cervical spine cohort and found that the sensitivity

of the NEXUS rule was only 93%. They also criticise the NEXUS rule for the poor reproducibility of 'presence of intoxication' and 'distracting painful injuries'. These criticisms have not been accepted by the developers of the NEXUS rules, who argued that the data collected by the Canadian group was inadequate to properly test the NEXUS criteria (Hoffman JR, personal communication).

The main difference in the performance of the rules lies in specificity. The NEXUS rule has a specificity of 13% (95% CI: 12.8-13.0) whereas the specificity of the Canadian cervical spine rule is 42% (95% CI: 40-44) for clinically significant injuries. In addition the Canadian cervical spine rule detected 27 out of 28 clinically insignificant spine fractures.

Because of the very large difference in specificity the ordering rate produced by the two rules is also markedly different. The NEXUS rule requires an 87% three-view plain radiography rate, whereas the Canadian cervical spine rule requires a 58% rate. It is important to note that NEXUS only found 498 of the 818 cervical spine abnormalities on plain radiography, as a very high number of plain radiographs were of inadequate quality. Another issue of concern is that 23 of the cervical fractures that were categorised as high risk by the NEXUS rule had plain radiographs that missed the fracture even though they were of good quality. These fractures were only picked up as further imaging was performed. The Canadian cervical spine rule paper did not comment on how many of their plain radiographs were of inadequate quality, and therefore how many patients had their fracture picked up by additional imaging.

In the Canadian study, 68% of the sample underwent plain radiography. All participants were telephoned at 14 days to assess for any missed injuries, as there was no other universal gold standard imaging applied, but 577 participants originally entered into the study could not be traced by telephone and did not have a cervical spine radiograph and so were later excluded. This is clearly of methodological concern. The NEXUS study performed three-view imaging in 87% of all participants. They had a different follow up protocol in that they set up a surveillance protocol, looking for any missed fractures returning to any of the participating hospitals. None was found.

The two rules overall adopt very different strategies in the generation of their rules in that the NEXUS group has selected clinical correlates from the history and the examination without advising any specific tests in the examination, whereas the Canadian rules have been generated around an interim test of the ability to actively rotate the neck, thereby increasing the specificity markedly. With regard to the similarities of the rules, NEXUS categorises patients who are not alert as high risk, whereas the Canadian rules considers such patients to be at high risk on an a priori basis. Both identify absence of midline tenderness as a means of triaging to low risk. NEXUS immediately puts them at low risk whereas the Canadian rule marks them as low risk if they can also rotate the neck. NEXUS identifies focal neurology as high risk and the Canadian rule identifies paraesthesia as high risk.

The main difference in the nature of the rules lies in the use of active neck rotation. NEXUS did not consider removal of the collar for examination as a safe procedure prior to imaging, whereas the Canadian rule found low risk criteria for safely performing active neck rotation, a manoeuvre that has an excellent specificity for exclusion of neck fracture. Due to this great difference in ethos, there are many differences in the two rules. The Canadians cite age greater than or equal to 65 years and dangerous mechanism as indications for immediate radiography, whereas these were not identified in the NEXUS rule. The Canadian rule also cites several specific low risk factors for the simple neck rotation test. The NEXUS rule uses

painful distracting injury and intoxication to select patients for radiography, whereas the Canadian investigators did not find these as useful as their other high risk factors

The two rules differ greatly in their approach to the assessment of patients at risk for a cervical injury. The NEXUS study is a much larger cohort and includes children and those who had a GCS score of less than 15. The Canadian rule is however much more specific and provides a validated rule that safely excludes 42% of patients who sustained a head injury from radiography. Neither rule however fully describes how to diagnose the fracture once someone has been identified as at high risk, because plain radiography is often inadequate and is not always 100% sensitive.

Clinical evidence from update 2007

In the update two diagnostic studies^{25,492} were identified (level I evidence) that examined patients with head injury and suspected cervical spine injury.

One prospective cohort study⁴⁹² comprised of 7438 consecutive adult patients with acute trauma to the head or neck who were in a stable and alert (GCS 15) condition. These patients had neck pain or no neck pain but visible injury above the clavicle and were non-ambulatory and had a dangerous mechanism of injury in nine Canadian emergency departments. This study sought to validate the CCR and also compares the outcomes to the NEXUS low risk criteria (NLR). Patients received an X-ray when ordered by the treating physician or were followed up with a structured telephone interview with a nurse to ensure no injuries were missed.

162 patients (2%) had cervical spine injury. The CCR had a higher sensitivity than NLC, which was 99.4% (95% CI, 96-100) compared to 90.7% (95% CI, 85-94) respectively. CCR had a higher specificity (45.1% [95% CI, 44-46]) compared to NLC (36.8% [95% CI, 36-38]). CCR had a lower ordering rate than NLC (55.9% vs 66.6%). The CCR missed one injury compared to NLC which only identified 147 of the 162 cervical spine injuries. There was an additional 845 patients selected that were excluded for the primary analysis. These patients were excluded as they were not tested on range of motion which is one of the criteria for the CCR prediction rule. Secondary analysis was conducted including these 'indeterminate' patients.

The second prospective cohort study retrieved²⁵ compared the CCR and physicians judgement. This study comprised of 6265 adult patients who were in a stable and alert (GCS 15) condition who had neck pain or no neck pain but visible injury above the clavicle and were non-ambulatory and had a dangerous mechanism of injury in ten Canadian emergency departments. This population was from Phase 1 of the original derivation study for the CCR. Physician's judgement was assessed to predict at least 0% probability of clinically important cervical spine injury. Patients received X-rays as requested by judgement of treating physician or were followed up at 14 days by structured telephone interview. There were 64 (1%) clinically important cervical spine injuries detected. CCR had a higher sensitivity of 100% (95% CI, 94-100) compared to physician judgement of 92.2% (95% CI, 94-100). Specificity was 44.0% (95% CI, 43-45) for CCR compared to 53.9% (95% CI, 82-96) for physician judgement.

Economics Evidence from 2007 update

There were no new published economic evidence for this question found in the update. We updated the unit costs in our cost analysis. The cost savings from the Canadian Cervical Spine Rule compared with the NEXUS rule were still present but were now more modest since radiology costs are lower.

Summary of evidence from 2007 update

The Canadian Cervical Spine Rule had a higher sensitivity than NEXUS low risk criteria and physician judgement. It should be noted that both studies^{25,492} came from the Canadian Cervical Spine Rule group. There is no new evidence to support CT spine for people with mild head injuries.

The Canadian Cervical Spine Rule still appears to be less costly than the NEXUS rule.

Rationale behind recommendation

In the 2003 guideline two evidence based decision rules for selection of patients who sustained a head injury for imaging of the cervical spine have been described. There was no clear means of choosing one over the other, and the choice of rule was therefore based on consensus. Based on the Guideline Development Group 2003 consensus, it was decided that the Canadian cervical spine rules should be used to identify patients who will require imaging of the cervical spine.

In order to provide guidance that covers all possibilities, the Canadian cervical spine rule had been slightly adapted as follows.

- Patients with GCS less than 15 at the time of assessment should have cervical spine imaging.
- Patients with focal neurological deficit should be included in the rule.
- Patients who have non-symptomatic risk factors (that is, are aged greater than or equal to 65 years, or who have had a dangerous mechanism of injury) should have some neck pain or tenderness before receiving cervical spine imaging.

UPDATE 2007:

The GDG decided that no change should be made to the original recommendation that Canadian Cervical Spine Rule (CCR) should be used for selecting patients with cervical spine damage for the most accurate imaging technique. GDG agreed that in cases where there is a severe head injury to an adult, a CT spine examination is required. There is a box on the child algorithm that allows some children to have a CT for severe injury. Adults and children should get CT spine if they are getting CT of the head. CT of all necks is not recommended as there is no evidence to suggest so.

O.1.11.4 Recommendations

For adults:

1. **Adult patients should have three-view radiograph imaging of the cervical spine requested immediately if any of the following points apply:**
 - **There is neck pain or midline tenderness with:**
 - **Age 65 years or older, or**
 - **dangerous mechanism of injury (fall from greater than 1 metre or five stairs; axial load to head for example, diving; high-speed motor vehicle collision; rollover motor accident; ejection from a motor vehicle; accident involving motorised recreational vehicles; bicycle collision).**
 - **It is not considered safe to assess the range of movement in the neck for reasons other than those above.**

- **It is considered safe to assess the range of movement in the neck and, on assessment, the patient cannot actively rotate the neck to 45 degrees to the left and right; safe assessment can be carried out if the patient:**
 - was involved in a simple rear-end motor vehicle collision
 - is comfortable in a sitting position in the emergency department
 - has been ambulatory at any time since the injury and there is no midline cervical spine tenderness
 - presents with delayed onset of neck pain.
- **A definitive diagnosis of cervical spine injury is required urgently (for example, before surgery). [2003, amended 2007]**

These recommendations are based on level one evidence and are considered to be grade A recommendations.

The Guideline Development Group 2003 considered this recommendation to be interim and dependant on future research likely to appear in time for the update guideline specifically the peer reviewed publication of the validation phase of the Canadian cervical spine rules.

For children:

- 2. Children under 10 years with GCS of 8 or less should have CT imaging of the cervical spine within 1 hour of presentation or when they are sufficiently stable. [2007]**

The recommendation is based on GDG opinion.

O.1.11.5 Imaging practice and involvement of the neurosurgical department

Urgency in performing CT of the head (2003)

Given the demands on CT scanners and radiologists trained in their use it is important to distinguish between those patients for whom CT imaging is required 'urgently' and those where CT can be performed 'within a reasonable period'.

Given that it is proposed that selection for head imaging be based upon the Canadian CT-head rules, it is possible to distinguish between those patients at high risk for need for neurosurgical intervention (the five point rules) and those at high risk for clinically important brain injuries (the seven point rules). The former set of patients will need CT imaging to be performed urgently (that is, within one hour of the request having been received) whereas the latter patients can wait for a reasonable period (4 hours) before imaging.

- 3. [Amended] CT imaging of the head should be performed (that is, imaging carried out and results analysed) within 1 hour of the request having been received by the radiology department in those patients where imaging is requested because of any of the following risk factors.**
 - GCS less than 13 on initial assessment in the emergency department.
 - GCS less than 15 at 2 hours after the injury.
 - Suspected open or depressed skull fracture.
 - Any sign of basal skull fracture (haemotympanum, 'panda' eyes, cerebrospinal fluid otorrhoea, Battle's sign).

- **More than one episode of vomiting in adults. In children more than 3 vomiting episodes (clinical judgement should be used regarding the cause of vomiting in those aged under or equal to 12 years, and whether imaging is necessary).**
 - **Post-traumatic seizure.**
 - **Coagulopathy (history of bleeding, clotting disorder, current treatment with warfarin) providing that some loss of consciousness or amnesia has been experienced. Patients receiving antiplatelet therapy may be at increased risk of intracranial bleeding but this is currently unquantified. Clinical judgement should be used to assess the need for an urgent scan in these patients.**
 - **Focal neurological deficit.**
- 4. [Amended] Patients who have any of the following risk factors and none of the above risk factors should have their CT imaging performed within 8 hours of the injury (imaging should be performed immediately in these patients if they present 8 hours or more after their injury).**
- **Amnesia for greater than 30 minutes of events before impact (the assessment of amnesia will not be possible in pre-verbal children and is unlikely to be possible in any child aged under 5 years).**
 - **Dangerous mechanism of injury (a pedestrian struck by a motor vehicle, an occupant ejected from a motor vehicle or a fall from a height of greater than 1 metre or five stairs) providing that some loss of consciousness or amnesia has been experienced. A lower threshold for height of falls should be used when dealing with infants and young children (that is, aged under 5 years). See section 4.8**

These recommendations are based on level two evidence and are considered to be grade B recommendations.

Cervical spine imaging urgency (2003)

The demands on X-ray facilities are not as pressing as those on CT facilities and there is no consequent need to discriminate between different categories of patient requiring cervical spine imaging. Cervical spine imaging if indicated should be carried out urgently as these patients will often need CT of the head once the cervical spine has been cleared.

- 5. Imaging of the cervical spine should be performed within 1 hour of a request having been received by the radiology department or when the patient is sufficiently stable. Where a request for urgent head CT (that is, within 1 hour) has also been received, the cervical spine imaging should also be carried out simultaneously. The timing of cervical spine CT in other patients should be dictated by clinical need.**

This recommendation is based on level five evidence and is considered to be a grade D recommendation.

O.1.11.6 Discharge and follow up

Discharge advice

- 6. All patients with any degree of head injury who are deemed safe for appropriate transfer to the community from an emergency department or the observation ward, should receive verbal advice and a written head injury advice card. The details of the**

card should be discussed with the patients and their carers. If necessary (for example, patients with literacy problems, visual impairment or speaking languages without a written format), other formats (for example, tapes) should be used to communicate this information. Communication in languages other than English should also be facilitated.

7. The risk factors outlined in the card should be the same as those used in the initial community setting to advise patients on emergency department attendance (see Chapter 4). Patients and carers should also be alerted to the possibility that some patients may make a quick recovery, but go on to experience delayed complications. Instructions should be included on contacting community services in the event of delayed complications.
8. Patients who presented to the emergency department with drug or alcohol intoxication and are now fit for discharge should receive information and advice on alcohol or drug misuse.

These recommendations are based on level five evidence and are considered to be grade D recommendations.

Advice about long term problems and support services (2003)

9. [Amended] All patients and their carers should be made aware of the possibility of long term symptoms and disabilities following head injury and should be made aware of the existence of services that they could contact should they experience long term problems. Details of support services should be included on patient discharge advice cards. Patients should also be advised to contact their doctor about these problems.

This recommendation is based on level five evidence and is considered to be a grade D recommendation.

Communication with community services (2003)

- 10.A communication (letter or email) should be generated for all patients who have attended the emergency department with a head injury, and sent to the patient's General Practitioner within 1 week of the end of the hospital episode. This letter should include details of the clinical history and examination. This letter should be open to the person or their carer, or a copy should be given to them.
- 11.A communication (letter or email) should be generated for all children who received head or cervical spine imaging, and sent to the relevant General Practitioner and school nurse for all school aged children within 1 week of the end of the hospital episode. This letter should include details of the clinical history and examination.
- 12.A communication (letter or email) should be generated for pre-school children who received head or cervical spine imaging, and sent to the General Practitioner and health visitor within 1 week of the end of the hospital episode. This letter should include details of the clinical history and examination.

These recommendations are based on level five evidence and are considered to be grade D recommendations.

O.2 Remit and scope

Scope for the development of a clinical guideline on Head Injury in Children and Adults - assessment, investigation, early management.

The original scope was not changed for this update of the guideline.

1 October 2001

O.2.1 Objective

1. The National Institute for Clinical Excellence has commissioned a clinical guideline for patients and clinicians on the early management of head injury. The guideline will provide advice on effective care using the best possible research evidence.
2. The commission received from the Department of Health and the National Assembly for Wales is in Figure 1

Figure 78: Commission from the Department of Health and National Assembly for Wales

All patients with head injuries are initially seen in an Accident & Emergency Department or walk-in centre. The A&E department must determine:

- which patients can go home without admission to hospital,
 - which patients with a relatively minor injury require admission to a hospital for a short period, i.e. not more than 48 hours,
 - which patients require transfer to a neurosurgical unit and may require neurosurgery,
 - after discussion with neurosurgeons, which severely head-injured
3. The Institute's clinical guidelines will support the implementation of National Service Frameworks (NSF) in those aspects of care where a framework has been published. The statements in each NSF reflect the evidence that was used at the time the framework was prepared. The clinical guidelines and technology appraisals published by the Institute after a NSF has been issued will have the effect of updating the framework.

O.2.2 Title

Head Injury in Children and Adults - assessment, investigation and early management.

O.2.3 Clinical Need and Practice

4. Each year 1.4 million people attend hospitals in England and Wales with a history of a recent head injury²⁰⁵. Between 40 and 50% of these are children under 15 years of age^{63,64}. The majority, around 80%, are diagnosed with 'mild' head injury and do not require hospital admission.
5. Annually, around 150,000 people are admitted to hospital with head injury. Of these, one third have features suggesting that their injury may have been sufficient to cause a skull fracture, or have evidence of brain damage. Approximately 6% of children with head injuries and 18% of adults with head injuries suffer from impaired consciousness^{233,234} and around 4,000 patients a year undergo a neurosurgical operation for an intracranial complication. Most patients recover without specific or specialist intervention but in others, persistent disability or even death result from the effects of complications, which can potentially be minimised or avoided with early detection and appropriate treatment.

6. Much of the controversy and uncertainty in the early care of head injured patients is focused upon how these patients are best managed.
7. Previous guidelines have been produced by neurosurgeons, including Briggs et al (1984)⁶⁰, Teasdale et al (1990)^{507,508} and the Society of British Neurological Surgeons (1998)⁴⁷⁶. Guidelines have also been produced by Working Parties of the Royal College of Surgeons of England (1999 and 2000)^{429,430} and by the Scottish Royal Colleges (Scottish Intercollegiate Guideline Network 2000)⁴⁵³.

O.2.4 Population

8. The guideline should offer best practice advice on the care of adults and children (including infants) who present with a suspected or confirmed traumatic head injury with or without other major trauma.
9. The guideline will not provide advice on the management of patients with other traumatic injury to the head (for example, to the eye or face).
10. The guideline will offer advice on the management of patients with a suspected or confirmed head injury who may be unaware that they have sustained a head injury because of intoxication or other causes.
11. The guideline will not address the rehabilitation or long term care of patients with a head injury but the guideline will provide criteria for the early identification of patients who would benefit from rehabilitation.

O.2.5 Health care setting

12. The guideline will cover the care received from primary care, ambulance and A&E staff who have direct contact with and make decisions concerning the care of patients who present with suspected or confirmed head injury. It will recognise the need for care to be integrated between the primary and secondary sectors.
13. It will address the management of patients in primary care, pre-hospital, in Accident and Emergency or similar units.
14. The guideline will be relevant to the work but will not cover the practice of others who may manage or treat people with a head injury (e.g., the police and first aiders).
15. The guideline will not address management within the neurosurgical unit.
16. Service configuration, competencies, skill mix and training requirements of staff are outside the scope of the guidelines, as they are the remit of the Modernisation Agency.
17. Whilst service configuration is best addressed at a local level, the developers will consider any strong evidence which links service settings and organisation, to patient outcomes.

O.2.6 Interventions and treatment

18. The guideline will address assessment and early management of suspected or confirmed head injury and will include:
 - Pre-hospital management including assessment, airway management and ventilation, cervical spine protection and appropriate transfer.
 - Referral to hospital. The guideline will cover indications for referral to hospital from pre-hospital care.
 - Secondary care with the aim of early detection of intracranial complications. To include:
 - o Admission for observation. This may be to a specific observation unit, in association with an Accident & Emergency, or to a surgical ward. The aim is to monitor neurological stability and arrange for appropriate diagnostic procedures and

treatment, if necessary. Deterioration carries a high likelihood of an intracranial complication but at this stage there may be insufficient time to intervene. Conversely, there is a longstanding concern that, despite existing guidelines, many patients are admitted unnecessarily and inappropriately.

- o Skull Radiography. The guideline will advise on the appropriate use of skull radiography to detect skull fracture and identify those at risk of intracranial complications.
 - o Other imaging procedures, including computed tomography (CT) scanning and nuclear magnetic resonance. The guideline will advise on the appropriate use of these and on radiation dosage where relevant.
 - o Criteria for transfer and discharge including circumstances when patients should be admitted to a Neurosurgical Unit, admitted for a short period or discharged home.
 - o Criteria for surgical intervention.
 - o Information for patients and their carer/s prior to and during hospital admission.
 - o Early discharge. The guideline will address the management at home of patients who are discharged within 48 hours of admission including:
 - Advice to primary care and Accident and Emergency staff on the management of patients who re-present with suspicious symptoms.
 - Guidance on appropriate handover arrangements
 - Information for patients and carers.
19. The guideline will not address investigative or surgical techniques.

O.2.7 Presentation

The guideline will be available in three forms:

- The full guideline containing the evidence base used by the developers.
- A short form version, using a standard template, which will form the Institute's guidance to the NHS including a clinical practice algorithm.
- A version, prepared specifically for patients and their carers, which will interpret the recommendations made in the Institute's short form version and will be designed to help patients and carers to make informed choices about their care.

O.2.8 Status

- This scoping statement has been out for a four-week period of consultation with stakeholders. The scope was then re-drafted and submitted to the Guidelines Advisory Committee and subsequently the Institute's Guidance Executive, for approval. Once approved, it was posted on the Institute's website, together with details of the Commissioning Brief and the name of the Collaborating Centre through which the guideline is being commissioned. The development of the guideline will begin in November 2001.
- Information on the guidelines development process, stakeholder involvement and the progress of this guideline is available on the website <http://www.nice.org.uk/>.

O.3 Declarations of Interest

O.3.1 GDG members, expert advisors and staff declarations of interest

Name	Interest
GDG Members	
David Yates	None
Nichola Chater	None
Paul Cooper	Small share holdings in a range of Pharmaceutical Companies.
Hilary Dent	None
Roger Evans	None
Chris Rowland Hill	None
David Lloyd	None
Gabrielle Lomas	Board member of Trauma Research Audit Network, TARN. Steering group member of RCN Emergency Care Association. Director and shareholder, Trauma Nursing Limited.
Ian Maconochie	None
David Mendelow	President of EMN. Chairman of Newcastle Neurosurgery Foundation LTD. Chairman of Spontaneous Intracranial Haemorrhage Group LTD Co. Consultant advisor for Astra-Zeneca and Novo Nordisc.
David Menon	Paid Consultant/lecturer for GlaxoSmithKline Ltd, Solvay Ltd and British Oxygen Corporation Ltd. Member of Management Board of Intensive Care National Audit and Research Centre. Member of Council of the Intensive Care Society. Member of Executive Board of the European Brain Injury Consortium. Director of Cambridge Neuromatics.
Edward Moss	None
David Murfin	Research Phase I pharmaceutical trials for Marix LTD.
Paul Sidi	None
Co-opted Advisors	
Joel Dunning	No interests were declared that required action
Archie Morson	No interests were declared that required action

Table 81: NCC-AC Staff

Name	Interest
Jennifer Hill	None
Carlos Sharpin	None
David Wonderling	None
Enrico De Nigris	None
Peter B Katz	None
Clare Jones	No interests were declared that required action
Kathryn Oliver	None
Rifna Aktar	None
Susan Murray	No interests were declared that required action
Kelly Dickinson	None
John Browne	None
Elisabetta Fenu	None
Caroline Lawson	None

GDG agreed: No action was required in relation to the above interests

O.4 Key Clinical Questions included in the update

Question Number	Questions
1	In deciding on the most appropriate destination for a patient with severe head injury, what are the benefits of direct transport to a specialist neurosciences centre compared to transport to the nearest district general hospital?
2	For patients who have suffered a clinically important brain injury that does not require surgical intervention and who have been transported to a non specialist centre, what are the benefits of the patient continuing on receiving treatment at that district general hospital versus being transferred to a neurosciences centre?
3	What is the best initial diagnostic technique to determine which patients have sustained damage to the head and require further assessment of the head?
4	What is the best clinical prediction rule for selecting patients with head injury for the imaging technique selected in question 3?
5	What is the best diagnostic technique to determine which patients have sustained damage to the cervical spine and require further assessment of cervical spine?
6	What are the best clinical prediction rule(s) for selecting patients that have sustained damage to the cervical spine for the imaging technique selected in question 5?
7	What is the harm associated with radiation to the head and/or spine?
8	Which is the best tool for identifying the patients who should be referred to rehabilitation services following the initial management of a head injury?

O.5 Search strategies

Systematic review of indications for computed tomography of the head

Medline search

- 1 Craniocerebral-Trauma/
- 2 Head-Injuries-Penetrating/
- 3 exp Head-Injuries-Closed/
- 4 exp Brain-Injuries/
- 5 (cerebral trauma).tw.
- 6 (craniocerebral trauma or cranio-
cerebral trauma).tw.
- 7 (head injur\$ or brain injur\$).tw.
- 8 (brain trauma or head trauma).tw.
- 9 Skull-Fractures/
- 10 Skull-Fracture-Depressed/
- 11 Skull-Fracture-Basilar/
- 12 (skull fracture\$).tw.
- 13 exp Intracranial-Hemorrhage-
Traumatic/
- 14 (intracranial injur\$ or intracranial
hematoma\$ or intracranial
haematoma\$ or intracranial
haemorrhage\$ or intracranial
haemorrhage\$ or epidural
hematoma\$ or epidural haematoma\$
or epidural haemorrhage\$ or epidural
haemorrhage\$ or subdural
hematoma\$ or subdural
haematoma\$ or subdural
haemorrhage\$ or subdural
haemorrhage\$ or extradural
hematoma\$ or extradural
haematoma\$ or extradural
haemorrhage\$ or extradural
haemorrhage\$).tw.
- 15 (brain lesions or intracranial lesions
or neurological lesions).tw.
- 16 (cerebral oedema\$ or cerebral
edema\$ or brain oedema\$ or brain
edema\$).tw.
- 17 or/1-12
- 18 or/13-16
- 19 or/1-13
- 20 Tomography-X-Ray-Computed/
- 21 (compute\$ tomograph\$ or ct).tw.
- 22 Tomography-X-Ray/
- 23 Radiography-/
- 24 (skull radiograph\$ or skull xray\$ or
skull X-ray\$).tw.
- 25 or/20-24
- 26 (((glasgow coma scale or gcs) near (13
or 14 or 15)) or mild or minor or
minimal).tw.

- 27 Animal/ not (Human/ and Animal/)
- 28 (biography or comment or editorial or
letter or news).pt.
- 29 27 or 28
- 30 (19 and 25 and 26) not 29
- 31 (17 and 18 and 25) not 29
- 32 29 or 30
- 33 limit 32 to yr=1990-2002

Embase search

- 1 head-injury/
- 2 exp brain-injury/
- 3 skull-injury/
- 4 skull-fracture/
- 5 skull-base-fracture/
- 6 (craniocerebral trauma or cranio-
cerebral trauma or cerebral
trauma).tw.
- 7 (brain trauma or head trauma).tw.
- 8 (head injur\$ or brain injur\$).tw.
- 9 (skull fracture\$).tw.
- 10 or/1-9
- 11 exp brain-hematoma/
- 12 epidural-hematoma/
- 13 brain-haemorrhage/
- 14 (intracranial injur\$ or intracranial
hematoma or intracranial
haematoma\$ or intracranial
haemorrhage\$ or intracranial
haemorrhage\$).tw.
- 15 (epidural hematoma\$ or epidural
haematoma\$ or epidural
haemorrhage\$ or epidural
haemorrhage\$ or extradural
hematoma\$ or extradural
haematoma\$ or extradural
haemorrhage\$ or extradural
haemorrhage\$).tw.
- 16 (subdural hematoma\$ or subdural
haematoma\$ or subdural
haemorrhage\$ or subdural
haemorrhage\$).tw.
- 17 (brain lesions or intracranial lesions
or neurological lesions).tw.
- 18 (cerebral edema or cerebral oedema
or brain edema or brain oedema).tw.
- 19 or/11-18
- 20 radiography/
- 21 skull-radiography/
- 22 computer-assisted-tomography/
- 23 brain-tomography/
- 24 (compute\$ tomograph\$ or ct).tw.
- 25 skull radiograph\$ or skull xray\$ or
skull X-ray\$

- 26 or/20-25
- 27 ((glasgow coma scale or gcs) near (13 or 14 or 15)) or mild or minor or minimal
- 28 Animal/ not (Human/ and Animal/)
- 29 (letter or comment or editorial).pt.
- 30 28 or 29
- 31 (10 and 26 and 27) not 30
- 32 (10 and 19 and 26) not 30
- 33 31 or 32
- 34 limit 33 to yr=1990-2002

Systematic review for indications for imaging of the cervical spine

Medline search

- 1 radiography/ or exp neuroradiography/
- 2 Spine/ra [Radiography]
- 3 exp Cervical Vertebrae/ra [Radiography]
- 4 Neck/ra [Radiography]
- 5 ((radiograph\$ or xray\$ or X-ray\$) adj25 (neck or spine or spinal)).mp.
- 6 1 or 2 or 3 or 4 or 5
- 7 exp Spinal Injuries/
- 8 Spinal Cord Injuries/
- 9 whiplash.mp.
- 10 exp Neck Injuries/
- 11 ((trauma or injur\$) adj25 (neck or spine or spinal)).mp.
- 12 7 or 8 or 9 or 10 or 11
- 13 cervical.mp.
- 14 (biography or comment or editorial or letter or news).pt.
- 15 Animal/ not (Human/ and Animal/)
- 16 14 or 15
- 17 (6 and 12 and 13) not 16
- 18 limit 17 to yr=1990-2002

Embase search

- 1 Cervical Spine Radiography/
- 2 spine/ or cervical spine/
- 3 Neck/
- 4 (neck or spine or spinal).tw.
- 5 (radiograph\$ or xray\$ or X-ray\$).tw.
- 6 1 or ((2 or 3 or 4) and 5)
- 7 spine injury/ or exp cervical spine injury/ or cervical spine fracture/ or cervical spine dislocation/
- 8 spinal cord injury/ or exp cervical spinal cord injury/
- 9 neck injury/ or exp whiplash injury/
- 10 whiplash.tw.

- 11 ((trauma or injur\$) adj25 (neck or spine or spinal)).tw.
- 12 or/7-10
- 13 cervical.mp.
- 14 (letter or comment or editorial).pt.
- 15 (Animal/ not (Human/ and Animal/))
- 16 14 or 15
- 17 (6 and 12 and 13) not 16
- 18 limit 17 to yr=1990-2002

Systematic review of means of identifying patients at high risk of late sequelae

Medline

- 1 Craniocerebral Trauma/
- 2 Head Injuries, Penetrating/
- 3 exp Head Injuries, Closed/
- 4 exp Brain Injuries/
- 5 (cerebral trauma or craniocerebral trauma or cranio-cerebral trauma).tw.
- 6 (head injur\$ or brain injur\$ or brain trauma or head trauma).tw.
- 7 skull fractures/ or skull fracture, basilar/ or skull fracture, depressed/
- 8 skull fracture\$.tw.
- 9 exp intracranial hemorrhage, traumatic/
- 10 or/1-9
- 11 ((glasgow coma scale adj ("13" or "14" or "15")) or (gcs adj ("13" or "14" or "15"))).tw.
- 12 (minor or mild or minimal or trivial).tw.
- 13 or/11-12
- 14 prognosis/ or exp treatment outcome/
- 15 incidence/ or exp mortality/ or follow-up studies/
- 16 mortality.sh.
- 17 (prognosis\$ or predict\$ or course).mp.
- 18 or/14-17
- 19 animal/ not (animal/ and human/)
- 20 (comment or letter or editorial).pt.
- 21 19 or 21
- 22 (10 and 13 and 18) not 21
- 23 limit 21 to yr=1990-2002

Embase

- 1 Head Injury/
- 2 exp Brain Injury/
- 3 skull injury/ or skull fracture/ or skull base fracture/
- 4 (craniocerebral trauma or cranio-cerebral trauma or cerebral trauma).tw.

5 (head injur\$ or brain injur\$ or brain
trauma or head trauma).tw.
6 or/1-5 (47310)
7 ((glasgow coma scale adj ("13" or
"14" or "15")) or (gcs adj ("13" or
"14" or "15"))).tw.
8 (minor or mild or minimal or
trivial).tw.
9 or/7-8
10 exp "Prediction and Forecasting"/
11 exp Treatment Outcome/
12 incidence/ or exp mortality/
13 exp Follow Up/
14 (prognosis\$ or predict\$ or
course).mp.
15 or/10-14
16 (editorial or comment or letter).pt.
17 (Animal/ not (Human/ and Animal/))
18 16 or 17
19 (6 and 9 and 15) not 16

*Systematic review of radiation risks associated
with computed tomography of the head*

Medline

1 Tomography, X-ray Computed/ or
(compute\$ tomograph\$ or ct).tw.
2 exp Radiation Injuries/
3 exp Neoplasms/
4 (neoplas\$ or cancer or tumor\$ or
tumour\$ or carcinoma\$ or
adenocarcinoma\$).mp.
5 or/3-4
6 exp Radiation/
7 Radiation Dosage/
8 (radiation adj5 (dose or dosage or
doses)).tw.
9 or/6-8
10 exp Risk/
11 exp Cohort Studies/
12 (odds and ratio).mp.
13 (relative and risk).mp.
14 (case and control).mp.
15 risk.mp.
16 or/13-18
17 (biography or comment or editorial
or letter or news).pt.
18 (Animal/ not (Human/ and Animal/))
19 10 or 11
20 (1 and (2 or (5 and 9 and 16))) not 19
20 limit 20 to yr=1990-2002

Embase

1 exp Computer Assisted Tomography/
2 (compute\$ tomograph\$ or ct).tw.
3 or/1-2

4 exp Radiation/
5 radiation/ or ionizing radiation/
6 exp Radiation Injury/
7 exp Radiation Exposure/
8 Radiation Dose/
9 Radiation Response/
10 (radiation adj (dose or dosage or
doses or expos\$)).tw.
11 or/4-10
12 exp Neoplasm/
13 (neoplas\$ or cancer or tumour\$ or
tumor\$ carcinoma\$ or
adenocarcinoma\$).tw.
14 or/12-13
15 Cancer Risk/
16 Radiation Carcinogenesis/
17 or/18-19
18 risk/ or risk assessment/ or risk
factor/
19 Cohort Analysis/
20 (odds and ratio).mp.
21 (relative and risk).mp.
22 (case and control).mp.
23 or/21-25
24 (letter or comment or editorial).pt.
24 (Animal/ not (Animal/ and Human/))
25 or/15-16
26 (3 and (17 or (11 and 14 and 23))) not
26
27 limit 27 to yr=1990-2002

**Head Injury Search Terms for HEED and NHS
Economic Evaluation Database**

NHS Economic Evaluation Database

1. explode 'Cranio-cerebral-Trauma' (MESH term)
2. cerebral trauma
3. craniocerebral trauma or cranio-cerebral trauma
4. head injur* or brain injur*
5. brain trauma or head trauma
6. skull fracture*
7. or/1-6

HEED

Similar search strategy used without the exploded MESH terms

**Cervical Spine Search Terms for HEED and
NHS Economic Evaluation Database**

NHS Economic Evaluation Database

1. neuroradiography
2. radiograph* or xray* or X-ray*
3. spine or spinal or neck or cervical vertebrae or cervical spine
4. 1 or (2 and 3)

HEED

Similar search strategy used

Medline and Embase used the same strategies for each clinical question, the cost papers being filtered from the search using the cost filter:

cost OR costs OR cost-effective OR cost-effectiveness OR costeffective OR costeffectiveness OR cost-benefit OR benefit-cost OR cost-effect* OR costeffect* OR costbenefi* OR benefit-cost* OR benefitcost* OR costbenefi* OR cost-utility OR economic OR cost-utility* OR costutility* OR economics OR econom* OR economics[MESH] OR "cost-effective" OR "cost-effectiveness" OR "cost-benefit" OR "benefit-cost" OR "cost-utility" OR costing OR costings OR costed OR QALY OR life-year OR "life year"

Direct transport/transfer to appropriate destination for a patient with severe head injury

Medline search

1. Craniocerebral-Trauma.DE. OR Head-Injuries-Penetrating.DE. OR Head-Injuries-Closed#.DE. OR Brain-Injuries#.DE.
2. ((cerebral OR craniocerebral) ADJ trauma OR (head OR brain) ADJ (injury OR injuries OR injured OR trauma)).TI,AB.
3. Skull-Fractures.DE. OR Skull-Fracture-Depressed.DE. OR Skull-Fracture-Basilar.DE.
4. (skull ADJ (fracture OR fractures)).TI,AB.
5. Intracranial-Hemorrhage-Traumatic#.DE.
6. (intracranial ADJ (injury OR injuries) OR (intracranial OR epidural OR subdural OR extradural) ADJ (haematoma OR haematomas OR hematoma OR hematomas OR hemorrhage OR hemorrhages OR haemorrhage OR haemorrhages)).TI,AB.
7. ((brain OR intracranial OR neurological) ADJ lesions).TI,AB.
8. ((cerebral OR brain) ADJ (oedema OR oedemas OR edema OR edemas)).TI,AB.
9. 1 OR 2 OR 3 OR 4 OR 5 OR 6 OR 7 OR 8

10. Hospitalization#.W..DE. OR (transfer\$4 OR transport\$6 OR ambulance OR university ADJ hospital).TI,AB.
11. Referral-and-Consultation.DE. OR refer\$4.TI,AB. OR ((tertiary OR neurological OR neurosurgical OR specialist OR trauma) ADJ (centre OR centres OR service\$) OR neurosurgery).TI,AB.
12. 10 OR 11
13. Randomized-Controlled-Trials.DE. OR Random-Allocation.DE. OR Double-Blind-Method.DE. OR Single-Blind-Method.DE. OR Clinical-Trials#.DE. OR Cross-Over-Studies.DE. OR Prospective-Studies.DE. OR Placebos.DE.
14. Randomized-Controlled-Trial.PT. OR Clinical-Trial.PT. OR Controlled-Clinical-Trial.PT.
15. ((clinical OR control OR controlled) ADJ (study OR trial) OR (single OR double OR triple) ADJ (blind\$3 OR mask\$3) OR randomi\$6 OR (random OR randomly) WITH (assign\$5 OR allocat\$4 OR group OR groups OR grouped OR patients OR study OR trial OR distribut\$4) OR crossover NEXT (design OR study OR trial) OR placebo OR placebos).TI,AB.
16. 13 OR 14 OR 15
17. Case-Reports.PT. NOT Randomized-Controlled-Trial.PT. OR Letter.PT. OR Historical-Article.PT. OR Review-Of-Reported-Cases.PT. OR Animals#.W..DE. NOT Humans.DE.
18. 16 NOT 17
19. Evaluation-Studies.DE. OR Epidemiologic-Studies.DE. OR Case-Control-Studies.DE. OR Cohort-Studies.DE. OR Cross-Sectional-Studies.DE. OR Intervention-Studies.DE. OR Prospective-Studies.DE. OR Observation.W..DE. OR Follow-Up-Studies.DE. OR Longitudinal-Studies.DE.
20. Evaluation-Studies.PT. OR Multicenter-Study.PT. OR Validation-Studies.PT.
21. (cohort OR case ADJ control OR prospective OR retrospective OR longitudinal OR cross ADJ sectional OR cross-sectional).TI,AB.
22. ((follow ADJ up OR follow-up OR observational OR epidemiology OR

- epidemiologic OR epidemiological)
ADJ (study OR studies)).TI,AB.
23. (time ADJ series OR pre-test OR pre
ADJ test OR post-test OR post ADJ
test OR before ADJ after OR
quasirandomised OR
quasirandomized OR quasi-
randomised OR quasi-randomized OR
quasi ADJ (randomised OR
randomized OR randomisation OR
randomization) OR
quasiexperimental OR quasi-
experimental OR quasi ADJ
(experimental OR
experimentation)).TI,AB.
24. 19 OR 20 OR 21 OR 22 OR 23
25. 9 AND 12 AND (18 OR 24)
26. limit set 25 YEAR > 1990
- Embase search
1. Head-Injury.DE. OR Brain-Injury#.DE.
2. ((cerebral OR craniocerebral) ADJ
trauma OR (head OR brain) ADJ
(injury OR injuries OR injured OR
trauma)).TI,AB.
3. Skull-Injury.DE. OR Skull-Fracture.DE.
OR Skull-Base-Fracture.DE.
4. (skull ADJ (fracture OR
fractures)).TI,AB.
5. Brain-Hematoma#.DE. OR Epidural-
Hematoma.DE. OR Brain-
Hemorrhage.DE.
6. (intracranial ADJ (injury OR injuries)
OR (intracranial OR epidural OR
subdural OR extradural) ADJ
(haematoma OR haematomas OR
hematoma OR hematomas OR
hemorrhage OR hemorrhages OR
haemorrhage OR
haemorrhages)).TI,AB.
7. ((brain OR intracranial OR
neurological) ADJ lesions).TI,AB.
8. ((cerebral OR brain) ADJ (oedema OR
oedemas OR edema OR
edemas)).TI,AB.
9. 1 OR 2 OR 3 OR 4 OR 5 OR 6 OR 7 OR
8
10. Hospitalization.W..DE. OR (transfer\$4
OR transport\$6 OR ambulance OR
university ADJ hospital).TI,AB.
11. Patient-Referral.DE. OR refer\$4.TI,AB.
OR ((tertiary OR neurological OR
neurosurgical OR specialist OR
trauma) ADJ (centre OR centres OR
service\$) OR neurosurgery).TI,AB.
12. 10 OR 11
13. Clinical-Trial.DE. OR Randomized-
Controlled-Trial.DE. OR
Randomization.W..DE. OR Single-
Blind-Procedure.DE. OR Double-
Blind-Procedure.DE. OR Crossover-
Procedure.DE. OR Prospective-
Study.DE. OR Placebo.DE.
14. ((clinical OR control OR controlled)
ADJ (study OR trial) OR (single OR
double OR triple) ADJ (blind\$3 OR
mask\$3) OR randomi\$6 OR (random
OR randomly) WITH (assign\$5 OR
allocat\$4 OR group OR groups OR
grouped OR patients OR study OR
trial OR distribut\$4) OR crossover
NEXT (design OR study OR trial) OR
placebo OR placebos).TI,AB.
15. 13 OR 14
16. Case-Study.DE. OR case ADJ report
OR Abstract-Report.DE. OR Letter.DE.
OR (Animal#.DE. OR Nonhuman.DE.
OR Animal-Experiment#.DE.) NOT
Human#.DE.
17. 15 NOT 16
18. Evaluation-and-Follow-Up.DE. Or
Evaluation.W..DE. OR Clinical-
Study.DE. OR Case-Control-Study.DE.
OR Family-Study.DE. OR Longitudinal-
Study.DE. OR Prospective-Study.DE.
OR Retrospective-Study.DE. OR
Cohort-Analysis.DE. OR Follow-
Up.DE. OR Comparative-Study.DE.
19. (cohort OR case ADJ control OR
prospective OR retrospective OR
longitudinal OR cross ADJ sectional
OR cross-sectional).TI,AB.
20. ((follow ADJ up OR follow-up OR
observational OR epidemiology OR
epidemiologic OR epidemiological)
ADJ (study OR studies)).TI,AB.
21. (time ADJ series OR pre-test OR pre
ADJ test OR post-test OR post ADJ
test OR before ADJ after OR
quasirandomised OR
quasirandomized OR quasi-
randomised OR quasi-randomized OR
quasi ADJ (randomised OR
randomized OR randomisation OR
randomization) OR
quasiexperimental OR quasi-
experimental OR quasi ADJ
(experimental OR
experimentation)).TI,AB.
22. 18 OR 19 OR 20 OR 21
23. 9 AND 12 AND (17 OR 22)
24. limit set 23 YEAR > 1990

Diagnostic tool for patients with head injury

Medline search

1. Craniocerebral-Trauma.DE. OR Head-Injuries-Penetrating.DE. OR Head-Injuries-Closed#.DE. OR Brain-Injuries#.DE.
2. ((cerebral OR craniocerebral) ADJ trauma OR (head OR brain) ADJ (injury OR injuries OR injured OR trauma)).TI,AB.
3. Skull-Fractures.DE. OR Skull-Fracture-Depressed.DE. OR Skull-Fracture-Basilar.DE.
4. (skull ADJ (fracture OR fractures)).TI,AB.
5. Intracranial-Hemorrhage-Traumatic#.DE.
6. (intracranial ADJ (injury OR injuries) OR (intracranial OR epidural OR subdural OR extradural) ADJ (haematoma OR haematomas OR hematoma OR hematomas OR hemorrhage OR hemorrhages OR haemorrhage OR haemorrhages)).TI,AB.
7. ((brain OR intracranial OR neurological) ADJ lesions).TI,AB.
8. ((cerebral OR brain) ADJ (oedema OR oedemas OR edema OR edemas)).TI,AB.
9. 1 OR 2 OR 3 OR 4
10. 5 OR 6 OR 7 OR 8
11. 1 OR 2 OR 3 OR 4 OR 5
12. Tomography-X-Ray-Computed.DE. OR Tomography-X-Ray.DE. OR Radiography.W..DE. OR RA.DE.
13. ((computed OR computer OR computerised OR computerized) ADJ (tomograph OR tomography OR tomographies OR tomographic OR tomographical OR tomographically) OR ct).TI,AB.
14. (skull ADJ radiograph\$ OR skull ADJ (xray\$ OR x-ray\$ OR x ADJ (ray OR rays))).TI,AB.
15. Magnetic-Resonance-Imaging#.DE.
16. (MRI OR magnetic ADJ resonance ADJ imaging).TI,AB.
17. 12 OR 13 OR 14 OR 15 OR 16
18. ((glasgow ADJ coma ADJ scale OR gcs) NEXT ('13' OR '14' OR '15')) OR mild OR minor OR minimal OR trivial).TI,AB.
19. Animals#.DE. NOT Humans.DE. OR (Biography OR Comment OR Editorial OR Letter OR News).PT.

20. (11 AND 17 AND 18) NOT 19
21. (9 AND 10 AND 17) NOT 19
22. 20 OR 21
23. (Diagnosis.W..DE. NOT Di.DE.) OR Diagnostic-Errors#.DE. OR Sensitivity-and-Specificity#.DE.
24. (diagnostic OR sensitivity OR specificity OR predictive ADJ value\$ OR accuracy OR likelihood ADJ (ratio OR ratios) OR false ADJ negative\$ OR false ADJ positive\$ OR true ADJ positive\$ OR true ADJ negative\$).TI,AB.
25. 23 OR 24
26. 22 AND 25
27. limit set 26 YEAR > 2002

Embase search

1. Head-Injury.DE. OR Brain-Injury#.DE.
2. ((cerebral OR craniocerebral) ADJ trauma OR (head OR brain) ADJ (injury OR injuries OR injured OR trauma)).TI,AB.
3. Skull-Injury.DE. OR Skull-Fracture.DE. OR Skull-Base-Fracture.DE.
4. (skull ADJ (fracture OR fractures)).TI,AB.
5. 1 OR 2 OR 3 OR 4
6. Brain-Hematoma#.DE. OR Epidural-Hematoma.DE. OR Brain-Hemorrhage.DE.
7. (intracranial ADJ (injury OR injuries) OR (intracranial OR epidural OR subdural OR extradural) ADJ (haematoma OR haematomas OR hematoma OR hematomas OR hemorrhage OR hemorrhages OR haemorrhage OR haemorrhages)).TI,AB.
8. ((brain OR intracranial OR neurological) ADJ lesions).TI,AB.
9. ((cerebral OR brain) ADJ (oedema OR oedemas OR edema OR edemas)).TI,AB.
10. 6 OR 7 OR 8 OR 9
11. Computer-Assisted-Tomography.DE. OR Brain-Tomography.DE. OR Radiography.W..DE. OR Skull-Radiography.DE.
12. ((computed OR computer OR computerised OR computerized) ADJ (tomograph OR tomography OR tomographies OR tomographic OR tomographical OR tomographically) OR ct).TI,AB.

13. (skull ADJ radiograph\$ OR skull ADJ (xray\$ OR x-ray\$ OR x ADJ (ray OR rays))).TI,AB.
14. Nuclear-Magnetic-Resonance-Imaging#.DE.
15. (MRI OR magnetic ADJ resonance ADJ imaging).TI,AB.
16. 11 OR 12 OR 13 OR 14 OR 15
17. ((glasgow ADJ coma ADJ scale OR gcs) NEXT ('13' OR '14' OR '15') OR mild OR minor OR minimal OR trivial).TI,AB.
18. Animal#.W..DE. NOT Human.W..DE. OR (Editorial OR Letter).AT.
19. (5 AND 16 AND 17) NOT 18
20. (5 AND 10 AND 16) NOT 18
21. 19 OR 20
22. (Diagnosis.W..DE. NOT Di.DE.) OR Diagnostic-Error#.DE. OR Sensitivity-and-Specificity#.DE.
23. (diagnostic OR sensitivity OR specificity OR predictive ADJ value\$ OR accuracy OR likelihood ADJ (ratio OR ratios) OR false ADJ negative\$ OR false ADJ positive\$ OR true ADJ positive\$ OR true ADJ negative\$).TI,AB.
24. 22 OR 23
25. 21 AND 24
26. limit set 25 YEAR > 2002
7. haemorrhage OR haemorrhages).TI,AB.
8. ((brain OR intracranial OR neurological) ADJ lesions).TI,AB.
9. ((cerebral OR brain) ADJ (oedema OR oedemas OR edema OR edemas)).TI,AB.
10. 1 OR 2 OR 3 OR 4
11. 5 OR 6 OR 7 OR 8
12. 1 OR 2 OR 3 OR 4 OR 5
13. Tomography-X-Ray-Computed.DE. OR Tomography-X-Ray.DE. OR Radiography.W..DE. OR RA.DE. ((computed OR computer OR computerised OR computerized) ADJ (tomograph OR tomography OR tomographies OR tomographic OR tomographical OR tomographically) OR ct).TI,AB.
14. (skull ADJ radiograph\$ OR skull ADJ (xray\$ OR x-ray\$ OR x ADJ (ray OR rays))).TI,AB.
15. Magnetic-Resonance-Imaging#.DE.
16. (MRI OR magnetic ADJ resonance ADJ imaging).TI,AB.
17. 12 OR 13 OR 14 OR 15 OR 16
18. ((glasgow ADJ coma ADJ scale OR gcs) NEXT ('13' OR '14' OR '15') OR mild OR minor OR minimal OR trivial).TI,AB.
19. Animals#.DE. NOT Humans.DE. OR (Biography OR Comment OR Editorial OR Letter OR News).PT.
20. (11 AND 17 AND 18) NOT 19
21. (9 AND 10 AND 17) NOT 19
22. 20 OR 21
23. Meta-Analysis.DE. OR Review-Literature#.DE.
24. Meta-Analysis.PT. OR ((selection ADJ criteria).AB. OR (data ADJ extraction).AB.) AND Review.PT.
25. (cochrane OR embase OR psychlit OR psyclit OR psychinfo OR psycinfo OR cinahl OR cinhal OR science ADJ citation ADJ index OR bids OR cancerlit).AB.
26. (reference ADJ ('LIST' OR lists) OR bibliograph\$ OR hand ADJ search\$ OR manual ADJ search\$ OR relevant ADJ journals).AB.
27. meta ADJ (analysis OR analyse OR analyses OR analysed OR analytic\$) OR metaanaly\$ OR meta-analy\$ OR systematic ADJ (review OR overview)
28. 23 OR 24 OR 25 OR 26 OR 27
- Clinical prediction rule for imaging of patients with head injury*
- Medline search
1. Craniocerebral-Trauma.DE. OR Head-Injuries-Penetrating.DE. OR Head-Injuries-Closed#.DE. OR Brain-Injuries#.DE.
2. ((cerebral OR craniocerebral) ADJ trauma OR (head OR brain) ADJ (injury OR injuries OR injured OR trauma)).TI,AB.
3. Skull-Fractures.DE. OR Skull-Fracture-Depressed.DE. OR Skull-Fracture-Basilar.DE.
4. (skull ADJ (fracture OR fractures)).TI,AB.
5. Intracranial-Hemorrhage-Traumatic#.DE.
6. (intracranial ADJ (injury OR injuries) OR (intracranial OR epidural OR subdural OR extradural) ADJ (haematoma OR haematomas OR hematoma OR hematomas OR hemorrhage OR hemorrhages OR

29. Comment.PT. OR Letter.PT. OR Editorial.PT. OR (Animals#.DE. NOT Humans.DE.)
30. 28 NOT 29
31. 22 AND 30
32. Guidelines#.W..DE.
33. (guideline\$ OR protocol OR consensus OR decision ADJ (rule OR rules)).TI,AB.
34. 32 OR 33
35. 22 AND 34
36. Predictive-Value-Of-Tests.DE.
37. (predict\$ OR validate\$ OR rule OR rules).TI,AB.
38. 36 OR 37
39. 22 AND 38
40. 31 OR 35 OR 39
41. limit set 40 YEAR > 2002
- Embase search
1. Head-Injury.DE. OR Brain-Injury#.DE.
2. ((cerebral OR craniocerebral) ADJ trauma OR (head OR brain) ADJ (injury OR injuries OR injured OR trauma)).TI,AB.
3. Skull-Injury.DE. OR Skull-Fracture.DE. OR Skull-Base-Fracture.DE.
4. (skull ADJ (fracture OR fractures)).TI,AB.
5. 1 OR 2 OR 3 OR 4
6. Brain-Hematoma#.DE. OR Epidural-Hematoma.DE. OR Brain-Hemorrhage.DE.
7. (intracranial ADJ (injury OR injuries) OR (intracranial OR epidural OR subdural OR extradural) ADJ (haematoma OR haematomas OR hematoma OR hematomas OR hemorrhage OR hemorrhages OR haemorrhage OR haemorrhages)).TI,AB.
8. ((brain OR intracranial OR neurological) ADJ lesions).TI,AB.
9. ((cerebral OR brain) ADJ (oedema OR oedemas OR edema OR edemas)).TI,AB.
10. 6 OR 7 OR 8 OR 9
11. Computer-Assisted-Tomography.DE. OR Brain-Tomography.DE. OR Radiography.W..DE. OR Skull-Radiography.DE.
12. ((computed OR computer OR computerised OR computerized) ADJ (tomograph OR tomography OR tomographies OR tomographic OR tomographical OR tomographically) OR ct).TI,AB.
13. (skull ADJ radiograph\$ OR skull ADJ (xray\$ OR x-ray\$ OR x ADJ (ray OR rays))).TI,AB.
14. Nuclear-Magnetic-Resonance-Imaging#.DE.
15. (MRI OR magnetic ADJ resonance ADJ imaging).TI,AB.
16. 11 OR 12 OR 13 OR 14 OR 15
17. ((glasgow ADJ coma ADJ scale OR gcs) NEXT ('13' OR '14' OR '15')) OR mild OR minor OR minimal OR trivial).TI,AB.
18. Animal#.W..DE. NOT Human.W..DE. OR (Editorial OR Letter).AT.
19. (5 AND 16 AND 17) NOT 18
20. (5 AND 10 AND 16) NOT 18
21. 19 OR 20
22. Meta-Analysis#.DE. OR Systematic-Review.DE.
23. ((selection ADJ criteria).AB. OR (data ADJ extraction).AB.) AND Review.AT.
24. (cochrane OR embase OR psychlit OR psyclit OR psychinfo OR psycinfo OR cinahl OR cinhal OR science ADJ citation ADJ index OR bids OR cancerlit).AB.
25. (reference ADJ ('LIST' OR lists) OR bibliograph\$ OR hand ADJ search\$ OR manual ADJ search\$ OR relevant ADJ journals).AB.
26. meta ADJ (analysis OR analyse OR analyses OR analysed OR analytic\$) OR metaanaly\$ OR meta-analy\$ OR systematic ADJ (review OR overview)
27. 22 OR 23 OR 24 OR 25 OR 26
28. Letter.AT. OR Editorial.AT. OR ((Animal#.DE. OR Nonhuman.DE. OR Animal-Experiment#.DE.) NOT Human#.DE.)
29. 27 NOT 28
30. 21 AND 29
31. Practice-Guideline#.DE.
32. (guideline\$ OR protocol OR consensus OR decision ADJ (rule OR rules)).TI,AB.
33. 31 OR 32
34. 21 AND 33
35. Methodology#.W..DE.
36. (predict\$ OR validate\$).TI,AB.
37. 35 OR 36
38. 21 AND 37
39. 30 OR 34 OR 38
40. limit set 39 YEAR > 2002

Diagnostic tools for patients with damage to the cervical spine

Medline search

1. Tomography-X-Ray-Computed.DE. OR Tomography-X-Ray.DE. OR Radiography.W..DE. OR Neuroradiography#.W..DE. OR Magnetic-Resonance-Imaging#.DE.
2. Spine-RA.DE.
3. Cervical-Vertebrae-RA#.DE.
4. Neck-RA.DE.
5. (((computed OR computer OR computerised OR computerized) ADJ (tomograph OR tomography OR tomographies OR tomographic OR tomographical OR tomographically) OR ct OR radiograph\$ OR xray\$ OR x-ray\$ OR x ADJ (ray OR rays) OR MRI OR magnetic ADJ resonance ADJ imaging) WITH (neck OR spine OR spinal)).TI,AB.
6. 1 OR 2 OR 3 OR 4 OR 5
7. Spinal-Injuries#.DE.
8. Spinal-Cord-Injuries.DE.
9. Neck-Injuries#.DE.
10. Whiplash.TI,AB.
11. ((trauma OR injury OR injuries OR injured) WITH (neck OR spine OR spinal)).TI,AB.
12. 7 OR 8 OR 9 OR 10 OR 11
13. cervical.TI,AB.
14. Animals#.DE. NOT Humans.DE. OR (Biography OR Comment OR Editorial OR Letter OR News).PT.
15. (6 and 12 and 13) not 14
16. (Diagnosis.W..DE. NOT Di.DE.) OR Diagnostic-Errors#.DE. OR Sensitivity-and-Specificity#.DE.
17. (diagnostic OR sensitivity OR specificity OR predictive ADJ value\$ OR accuracy OR likelihood ADJ (ratio OR ratios) OR false ADJ negative\$ OR false ADJ positive\$ OR true ADJ positive\$ OR true ADJ negative\$).TI,AB.
18. 16 OR 17
19. 15 AND 18
20. limit set 19 YEAR > 2002
5. ((computed OR computer OR computerised OR computerized) ADJ (tomograph OR tomography OR tomographies OR tomographic OR tomographical OR tomographically) OR ct OR radiograph\$ OR xray\$ OR x-ray\$ OR x ADJ (ray OR rays) OR MRI OR magnetic ADJ resonance ADJ imaging).TI,AB.
6. 1 OR ((2 OR 3) AND (4 OR 5))
7. Spine-Injury.DE. OR Cervical-Spine-Injury#.DE. OR Cervical-Spine-Fracture.DE. OR Cervical-Spine-Dislocation.DE.
8. Spinal-Cord-Injury.DE. OR Cervical-Spinal-Cord-Injury#.DE.
9. Neck-Injury#.DE.
10. Whiplash.TI,AB.
11. ((trauma OR injury OR injuries OR injured) WITH (neck OR spine OR spinal)).TI,AB.
12. 7 OR 8 OR 9 OR 10 OR 11
13. cervical.TI,AB.
14. Animal#.W..DE. NOT Human.W..DE. OR (Editorial OR Letter).AT.
15. (6 AND 12 AND 13) NOT 14
16. (Diagnosis.W..DE. NOT Di.DE.) OR Diagnostic-Error#.DE. OR Sensitivity-and-Specificity#.DE.
17. (diagnostic OR sensitivity OR specificity OR predictive ADJ value\$ OR accuracy OR likelihood ADJ (ratio OR ratios) OR false ADJ negative\$ OR false ADJ positive\$ OR true ADJ positive\$ OR true ADJ negative\$).TI,AB.
18. 16 OR 17
19. 15 AND 18
20. limit set 19 YEAR > 2002

Clinical prediction rule for imaging of patients with damage to the cervical spine

Medline search

1. Tomography-X-Ray-Computed.DE. OR Tomography-X-Ray.DE. OR Radiography.W..DE. OR Neuroradiography#.W..DE. OR Magnetic-Resonance-Imaging#.DE.
2. Spine-RA.DE.
3. Cervical-Vertebrae-RA#.DE.
4. Neck-RA.DE.
5. (((computed OR computer OR computerised OR computerized) ADJ (tomograph OR tomography OR tomographies OR tomographic OR tomographical OR tomographically)
1. Cervical-Spine-Radiography.DE.
2. Spine.W..DE. OR Cervical-Spine.DE. OR Neck.W..DE.
3. (neck OR spine OR spinal).TI,AB.
4. Radiography.W..DE. OR Computer-Assisted-Tomography.DE. OR Nuclear-Magnetic-Resonance-Imaging#.DE.

- OR ct OR radiograph\$ OR xray\$ OR x-ray\$ OR x ADJ (ray OR rays) OR MRI OR magnetic ADJ resonance ADJ imaging) WITH (neck OR spine OR spinal)).TI,AB.
6. 1 OR 2 OR 3 OR 4 OR 5
 7. Spinal-Injuries#.DE.
 8. Spinal-Cord-Injuries.DE.
 9. Neck-Injuries#.DE.
 10. Whiplash.TI,AB.
 11. ((trauma OR injury OR injuries OR injured) WITH (neck OR spine OR spinal)).TI,AB.
 12. 7 OR 8 OR 9 OR 10 OR 11
 13. cervical.TI,AB.
 14. Animals#.DE. NOT Humans.DE. OR (Biography OR Comment OR Editorial OR Letter OR News).PT.
 15. (6 and 12 and 13) not 14
 16. Meta-Analysis.DE. OR Review-Literature#.DE.
 17. Meta-Analysis.PT. OR ((selection ADJ criteria).AB. OR (data ADJ extraction).AB.) AND Review.PT.
 18. (cochrane OR embase OR psychlit OR psyclit OR psychinfo OR psycinfo OR cinahl OR cinhal OR science ADJ citation ADJ index OR bids OR cancerlit).AB.
 19. (reference ADJ ('LIST' OR lists) OR bibliograph\$ OR hand ADJ search\$ OR manual ADJ search\$ OR relevant ADJ journals).AB.
 20. meta ADJ (analysis OR analyse OR analyses OR analysed OR analytic\$) OR metaanaly\$ OR meta-analy\$ OR systematic ADJ (review OR overview)
 21. 16 OR 17 OR 18 OR 19 or 20
 22. Comment.PT. OR Letter.PT. OR Editorial.PT. OR (Animals#.DE. NOT Humans.DE.)
 23. 21 NOT 22
 24. 15 AND 23
 25. Guidelines#.W..DE.
 26. (guideline\$ OR protocol OR consensus).TI,AB.
 27. 25 OR 26
 28. 15 AND 27
 29. Predictive-Value-Of-Tests.DE.
 30. (predict\$ OR validate\$ OR rule OR rules).TI,AB.
 31. 29 OR 30
 32. 15 AND 31
 33. 24 OR 28 OR 32
 34. limit set 33 YEAR > 2002
- Embase search
1. Cervical-Spine-Radiography.DE.
 2. Spine.W..DE. OR Cervical-Spine.DE. OR Neck.W..DE.
 3. (neck OR spine OR spinal).TI,AB.
 4. Radiography.W..DE. OR Computer-Assisted-Tomography.DE. OR Nuclear-Magnetic-Resonance-Imaging#.DE.
 5. ((computed OR computer OR computerised OR computerized) ADJ (tomograph OR tomography OR tomographies OR tomographic OR tomographical OR tomographically) OR ct OR radiograph\$ OR xray\$ OR x-ray\$ OR x ADJ (ray OR rays) OR MRI OR magnetic ADJ resonance ADJ imaging).TI,AB.
 6. 1 OR ((2 OR 3) AND (4 OR 5))
 7. Spine-Injury.DE. OR Cervical-Spine-Injury#.DE. OR Cervical-Spine-Fracture.DE. OR Cervical-Spine-Dislocation.DE.
 8. Spinal-Cord-Injury.DE. OR Cervical-Spinal-Cord-Injury#.DE.
 9. Neck-Injury#.DE.
 10. Whiplash.TI,AB.
 11. ((trauma OR injury OR injuries OR injured) WITH (neck OR spine OR spinal)).TI,AB.
 12. 7 OR 8 OR 9 OR 10 OR 11
 13. cervical.TI,AB.
 14. Animal#.W..DE. NOT Human.W..DE. OR (Editorial OR Letter).AT.
 15. (6 AND 12 AND 13) NOT 14
 16. Meta-Analysis#.DE. OR Systematic-Review.DE.
 17. ((selection ADJ criteria).AB. OR (data ADJ extraction).AB.) AND Review.AT.
 18. (cochrane OR embase OR psychlit OR psyclit OR psychinfo OR psycinfo OR cinahl OR cinhal OR science ADJ citation ADJ index OR bids OR cancerlit).AB.
 19. (reference ADJ ('LIST' OR lists) OR bibliograph\$ OR hand ADJ search\$ OR manual ADJ search\$ OR relevant ADJ journals).AB.
 20. meta ADJ (analysis OR analyse OR analyses OR analysed OR analytic\$) OR metaanaly\$ OR meta-analy\$ OR systematic ADJ (review OR overview)
 21. 16 OR 17 OR 18 OR 19 OR 20
 22. Letter.AT. OR Editorial.AT. OR ((Animal#.DE. OR Nonhuman.DE. OR Animal-Experiment#.DE.) NOT Human#.DE.)
 23. 21 NOT 22

24. 15 AND 23
25. Practice-Guideline#.DE.
26. (guideline\$ OR protocol OR consensus OR decision ADJ (rule OR rules)).TI,AB.
27. 25 OR 26
28. 15 AND 27
29. Methodology#.W..DE.
30. (predict\$ OR validate\$).TI,AB.
31. 29 OR 30
32. 15 AND 31
33. 24 OR 28 OR 32
34. limit set 33 YEAR > 2002

Harm associated with radiation to the head and/or spine

Medline search

1. Tomography-X-Ray-Computed.DE. OR ((computed OR computer OR computerised OR computerized) ADJ (tomograph OR tomography OR tomographies OR tomographic OR tomographical OR tomographically) OR ct).TI,AB.
2. Radiation-Injuries#.DE.
3. Neoplasms#.W..DE.
4. (neoplasm OR neoplasms OR neoplasia OR neoplastic OR cancer OR tumor OR tumors OR tumour OR tumours OR carcinoma OR carcinomas OR adenocarcinoma OR adenocarcinomas).TI,AB.
5. 1 OR 2 OR 3 OR 4
6. Radiation#.W..DE.
7. Radiation-Dosage.DE.
8. (radiation WITH (dose OR dosage OR doses OR exposure OR exposures OR exposed OR expose)).TI,AB.
9. 6 OR 7 OR 8
10. Risk#.W..DE. OR risk.TI,AB.
11. Cohort-Studies#.DE.
12. Odds-Ratio.DE. OR (odds ADJ ratio).TI,AB.
13. Case-Control-Studies.DE. OR (case ADJ control).TI,AB.
14. 10 OR 11 OR 12 OR 13
15. Animals#.DE. NOT Humans.DE. OR (Biography OR Comment OR Editorial OR Letter OR News).PT.
16. (1 AND (2 OR (5 AND 9 AND 14))) NOT 15
17. limit set 16 YEAR > 2002

Embase search

1. Tomography-X-Ray-Computed.DE. OR ((computed OR computer OR

- computerised OR computerized) ADJ (tomograph OR tomography OR tomographies OR tomographic OR tomographical OR tomographically) OR ct).TI,AB.
2. Radiation#.W..DE.
3. Radiation-Injury#.DE.
4. Radiation-Exposure#.DE.
5. Radiation-Dose.DE.
6. Radiation-Response.DE.
7. (radiation WITH (dose OR dosage OR doses OR exposure OR exposures OR exposed OR expose)).TI,AB.
8. 2 OR 3 OR 4 OR 5 OR 6 OR 7
9. Neoplasm#.W..DE.
10. (neoplasm OR neoplasms OR neoplasia OR neoplastic OR cancer OR tumor OR tumors OR tumour OR tumours OR carcinoma OR carcinomas OR adenocarcinoma OR adenocarcinomas).TI,AB.
11. 9 OR 10
12. Cancer-Risk.DE.
13. Radiation-Carcinogenesis.DE.
14. 12 OR 13
15. Risk.W..DE. OR Risk-Assessment.DE. OR Risk-Factor.DE. OR risk.TI,AB.
16. Cohort-Analysis.DE.
17. (odds ADJ ratio).TI,AB.
18. Case-Control-Study.DE. OR (case ADJ control).TI,AB.
19. 15 OR 16 OR 17 OR 18
20. Animal#.W..DE. NOT Human.W..DE. OR (Editorial OR Letter).AT.
21. (1 AND (14 OR (8 AND 11 AND 19))) NOT 20
22. limit set 21 YEAR > 2002

Best tool for identifying the patients who should be referred to rehabilitation services following the initial management of a head injury

Medline search

1. Craniocerebral-Trauma.DE.
2. Head-Injuries-Penetrating.DE.
3. Head-Injuries-Closed#.DE.
4. Brain-Injuries#.DE.
5. ((cerebral OR craniocerebral) ADJ trauma).TI,AB.
6. ((head OR brain) ADJ (injury OR injuries OR injured OR trauma)).TI,AB.
7. Skull-Fractures.DE.
8. Skull-Fracture-Depressed.DE.
9. Skull-Fracture-Basilar.DE.

10. (skull ADJ (fracture OR fractures)).TI,AB.
11. Intracranial-Hemorrhage-Traumatic#.DE.
12. 1 OR 2 OR 3 OR 4 OR 5 OR 6 OR 7 OR 8 OR 9 OR 10 OR 11
13. ((glasgow ADJ coma ADJ scale OR gcs) NEXT ('13' OR '14' OR '15') OR mild OR minor OR minimal OR trivial).TI,AB.
14. Prognosis.W..DE. OR Treatment-Outcome#.DE.
15. Incidence.W..DE. OR Mortality#.W..DE. OR Follow-Up-Studies.DE.
16. Mo.DE.
17. (prognos\$ OR predict\$ OR course).TI,AB.
18. 14 OR 15 OR 16 OR 17
19. rehabilitat\$.DE. OR rehabilitat\$.TI,AB.
20. Animals#.DE. NOT Humans.DE. OR (Biography OR Comment OR Editorial OR Letter OR News).PT.
21. (12 AND 13 AND (18 OR 19)) NOT 20
22. limit set 21 YEAR > 2002

Embase

1. Head-Injury.DE.
2. Brain-Injury#.DE.
3. ((cerebral OR craniocerebral) ADJ trauma).TI,AB.
4. ((head OR brain) ADJ (injury OR injuries OR injured OR trauma)).TI,AB.
5. Skull-Injury.DE.
6. Skull-Fracture.DE.
7. Skull-Base-Fracture.DE.
8. (skull ADJ (fracture OR fractures)).TI,AB.
9. 1 OR 2 OR 3 OR 4 OR 5 OR 6 OR 7 OR 8
10. ((glasgow ADJ coma ADJ scale OR gcs) NEXT ('13' OR '14' OR '15') OR mild OR minor OR minimal OR trivial).TI,AB.
11. Prediction-and-Forecasting#.DE. OR Prognosis.W..DE.
12. Treatment-Outcome#.DE.
13. Incidence.W..DE. OR Mortality#.W..DE. OR Follow-Up#.DE.
14. (prognos\$ OR predict\$ OR course).TI,AB.
15. 11 OR 12 OR 13 OR 14
16. rehabilitat\$.DE. OR rehabilitat\$.TI,AB.
17. Animal#.W..DE. NOT Human.W..DE. OR (Editorial OR Letter).AT.
18. (9 AND 10 AND (15 OR 16)) NOT 17

19. limit set 18 YEAR > 2002

Clinical prediction rules for patients with head injury

Medline search

1. Craniocerebral-Trauma.DE. OR Head-Injuries-Penetrating.DE. OR Head-Injuries-Closed#.DE. OR Brain-Injuries#.DE.
2. ((head OR brain) ADJ (injury OR injuries OR injured OR trauma)).TI,AB.
3. 1 OR 2
4. Predictive-Value-Of-Tests.DE.
5. (predict\$ OR validat\$ OR rule OR rules).TI,AB.
6. 4 OR 5
7. YEAR=2006 OR YEAR=2005 OR YEAR=2004 OR YEAR=2003 OR YEAR=2002
8. Comment.PT. OR Letter.PT. OR Editorial.PT. OR Animals#.DE. NOT Humans.DE.
9. (3 AND 6 AND 7) NOT 8

Embase search

1. Head-Injury.DE. OR Brain-Injury#.DE.
2. ((head OR brain) ADJ (injury OR injuries OR injured OR trauma)).TI,AB.
3. 1 OR 2
4. Methodology#.W..DE.
5. (predict\$ OR validat\$).TI,AB.
6. 4 OR 5
7. YEAR=2006 OR YEAR=2005 OR YEAR=2004 OR YEAR=2003 OR YEAR=2002
8. Letter.AT. OR Editorial.AT. OR (Animal#.DE. OR Nonhuman.DE. OR Animal-Experiment#.DE.) NOT Human#.DE.
9. (3 AND 6 AND 7) NOT 8

Psycinfo search

1. Head-Injuries#.DE.
2. ((head OR brain) ADJ (injury OR injuries OR injured OR trauma)).TI,AB.
3. 1 OR 2
4. Prediction.W..DE.
5. (predict\$4 OR validat\$4 OR rule OR rules).TI,AB.
6. 4 OR 5
7. YEAR=2006 OR YEAR=2005 OR YEAR=2004 OR YEAR=2003 OR YEAR=2002
8. 3 AND 6 AND 7

Head injury economic searches

NHS Economic Evaluation Database (NHSEED)

1. MeSH descriptor Craniocerebral Trauma
2. MeSH descriptor Head Injuries, Penetrating
3. MeSH descriptor Head Injuries, Closed explode all trees
4. MeSH descriptor Brain Injuries explode all trees
5. ((cerebral OR craniocerebral) NEXT trauma) OR ((head OR brain) NEXT (injur* OR trauma*)) in Record Title
6. ((cerebral OR craniocerebral) NEXT trauma) OR ((head OR brain) NEXT (injur* OR trauma*)) in Abstract
7. MeSH descriptor Skull Fractures
8. MeSH descriptor Skull Fracture, Depressed
9. MeSH descriptor Skull Fracture, Basilar
10. skull NEXT fracture* in Record Title
11. skull NEXT fracture* in Abstract
12. MeSH descriptor Intracranial Hemorrhage, Traumatic explode all trees
13. (intracranial NEXT injur*) OR ((intracranial OR epidural OR subdural OR extradural) NEXT (haematoma* OR hematoma* OR haemorrhage* or hemorrhage*)) in Record Title
14. (intracranial NEXT injur*) OR ((intracranial OR epidural OR subdural OR extradural) NEXT (haematoma* OR hematoma* OR haemorrhage* or hemorrhage*)) in Abstract
15. (cerebral OR brain) NEXT (oedema* OR edema*) in Record Title
16. (cerebral OR brain) NEXT (oedema* OR edema*) in Abstract
17. #1 OR #2 OR #3 OR #4 OR #5 OR #6 OR #7 OR #8 OR #9 OR #10 OR #11 OR #12 OR #13 OR #14 OR #15 OR #16
18. MeSH descriptor Spinal Injuries explode all trees
19. MeSH descriptor Spinal Cord Injuries
20. MeSH descriptor Neck Injuries explode all trees
21. whiplash in Record Title
22. whiplash in Abstract
23. (trauma OR injur*) AND (neck OR spine OR spinal) in Record Title

24. (trauma OR injur*) AND (neck OR spine OR spinal) in Abstract
25. #18 OR #19 OR #20 OR #21 OR #22 OR #23 OR #24
26. cervical in Record Title
27. cervical in Abstract
28. #25 AND (#26 OR #27)
29. #17 OR #28 from 2002 to 2006

Health Economic Evaluations Database (HEED)

1. AX='head injury' OR 'head injuries' OR 'head injured' OR 'brain injury' OR 'brain injuries' OR 'brain injured' OR 'intracranial injury' OR 'intracranial injuries' OR 'head trauma' OR 'brain trauma'
2. AX='skull fracture' OR 'skull fractures'
3. CS = 1 OR 2
4. AX=trauma OR injur*
5. AX=spine or spinal or neck
6. AX=whiplash
7. CS = (4 AND 5) OR 6
8. AX=cervical
9. CS = 7 AND 8
10. TE='Applied Study' OR 'Review of Applied Studies'
11. JD>=2002
12. CS = (3 OR 9) AND 10 AND 11

Medline and Embase used the same strategies for each clinical question, the cost papers being filtered from the search using the following cost filters:

Medline

1. Economics.W..DE. OR Economics-Hospital#.DE. OR Economics-Medical#.DE. OR Economics-Nursing.DE. OR Economics-Pharmaceutical.DE.
2. Costs-and-Cost-Analysis.DE. OR Cost-Allocation.DE. OR Cost-Benefit-Analysis.DE. OR Cost-Control.DE. OR Cost-Savings.DE. OR Cost-Of-Illness.DE. OR Cost-Sharing.DE. OR Health-Care-Costs.DE. OR Direct-Service-Costs.DE. OR Drug-Costs.DE. OR Employer-Health-Costs.DE. OR Hospital-Costs.DE.
3. Health-Expenditures.DE. OR Capital-Expenditures.DE. OR Fees-and-Charges#.DE. OR Budgets#.DE. OR Deductibles-and-Coinsurance.DE. OR Medical-Savings-Accounts.DE. OR Value-Of-Life.DE. OR Quality-Adjusted-Life-Years.DE.

4. ((low OR high OR unit OR healthcare OR health ADJ care OR health-care OR hospital OR benefit) ADJ (cost OR costs OR costing OR costings)).TI,AB. OR ((cost OR costs OR costing OR costings) ADJ (estimate\$ OR variable OR effectiv\$ OR benefit\$)).TI,AB.
 5. fiscal OR funding OR financial OR finance OR economic\$ OR pharmaco-economic\$ OR price OR prices OR pricing OR (QALY\$ OR life-year\$ OR cost-effectiv\$ OR cost-effectiv\$ OR cost-benefit\$ OR cost-benefit\$).TI,AB.
 6. 1 OR 2 OR 3 OR 4 OR 5
2. Effectiveness-Analysis.DE. OR Cost-Of-Illness.DE. OR Cost-Control.DE. OR Economic-Aspect.DE. OR Financial-Management.DE. OR Health-Care-Cost.DE. OR Health-Care-Financing.DE. OR Health-Economics.DE. OR Hospital-Cost.DE. OR Cost-Minimization-Analysis.DE.
 3. fiscal OR financial OR finance OR funding OR (cost ADJ (estimate\$ OR variable\$)).TI,AB. OR (unit ADJ (cost OR costs OR costing OR costings)).TI,AB.
 - 1 OR 2

Embase

1. Socioeconomics.W..DE. OR Cost-Benefit-Analysis.DE. OR Cost-

O.6 Suggested written discharge advice

O.6.1 Suggested written discharge advice card for patients aged over 12 years who have sustained a head injury

We think that it is alright for you to leave hospital now. We have checked your symptoms and you seem well on the road to recovery. When you get home it is very unlikely that you will have any further problems. But, if any of the following symptoms do return, we suggest you come back, or get someone to bring you back to your nearest hospital emergency department as soon as possible:

- unconsciousness, or lack of full consciousness (for example, problems keeping eyes open)
- any confusion (not knowing where you are, getting things muddled up)
- any drowsiness (feeling sleepy) that goes on for longer than one hour when you would normally be wide awake
- any problems understanding or speaking
- any loss of balance or problems walking
- any weakness in one or more arms or legs
- any problems with your eyesight
- very painful headache that won't go away
- any vomiting – getting sick
- any fits (collapsing or passing out suddenly)
- clear fluid coming out of your ear or nose
- bleeding from one or more ears
- new deafness in one or more ears

Things you shouldn't worry about

You may feel some other symptoms over the next few days which should disappear in the next 2 weeks. These include a mild headache, feeling sick (without vomiting), dizziness, irritability or bad temper, problems concentrating or problems with your memory, tiredness, lack of appetite or problems sleeping. If you feel very concerned about any of these symptoms in the first few days after discharge, you should go and see your own doctor to talk about them. **If these problems do not go away after 2 weeks, you should go and see your doctor. We would also recommend that you seek a doctor's opinion about your ability to drive a car or motorbike.**

Things that will help you get better

If you follow this advice you should get better more quickly and it may help any symptoms you have to go away:

- DO NOT stay at home alone for the first 48 hours after leaving hospital.
- DO make sure you stay within easy reach of a telephone and medical help.
- DO have plenty of rest and avoid stressful situations
- DO NOT take any alcohol or drugs
- DO NOT take sleeping pills, sedatives or tranquilisers unless they are given by a doctor

- DO NOT play any contact sport (for example, rugby or football) for at least 3 weeks without talking to your doctor first
- DO NOT return to your normal school, college or work activity until you feel you have completely recovered
- DO NOT drive a car, motorbike or bicycle or operate machinery unless you feel you have completely recovered

Telephone number to call at the hospital _____

Long term problems

Most patients recover quickly from their accident and experience no long term problems. However, some patients only develop problems after a few weeks or months. If you start to feel that things are not quite right (for example, memory problems, not feeling yourself), then please contact your doctor as soon as possible so that we can check to make sure you are recovering properly.

O.6.2 Suggested written discharge advice card for carers of children who have sustained a head injury

We think that it is alright for your child to leave hospital now. We have checked their symptoms and they seem well on the road to recovery. When you get them home it is very unlikely that they will have any further problems. But, if any of the following symptoms do return, we suggest you bring them back to their nearest hospital emergency department as soon as possible:

- unconsciousness, or lack of full consciousness (for example, problems keeping eyes open)
- any confusion (not knowing where they are, getting things muddled up)
- any drowsiness (feeling sleepy) that goes on for longer than one hour when they would normally be wide awake
- difficulty waking the patient up
- any problems understanding or speaking
- any loss of balance or problems walking
- any weakness in one or more arms or legs
- any problems with their eyesight
- very painful headache that won't go away
- any vomiting – getting sick
- any fits (collapsing or passing out suddenly)
- clear fluid coming out of their ear or nose
- bleeding from one or more ears
- new deafness in one or more ears

Things you shouldn't worry about

They may feel some other symptoms over the next few days which should disappear in the next 2 weeks. These include a mild headache, feeling sick (without vomiting), dizziness, irritability or bad temper, problems concentrating or problems with their memory, tiredness, lack of appetite or problems sleeping. If you feel very concerned about any of these symptoms in the first few days after discharge, you should bring the patient to their doctor. **If these problems do not go away after 2 weeks, you should bring the patient to see their doctor.**

Things that will help the patient get better

If the patient follows this advice it should help them get better more quickly and it may help any symptoms they have to go away:

- DO have plenty of rest and avoid stressful situations
- DO NOT take sleeping pills, sedatives or tranquilisers unless they are given by a doctor
- DO NOT play any contact sport (for example, football) for at least 3 weeks without talking to their doctor first

Things you should do to make sure the patient is OK

- DO NOT allow them to return to school until you feel they have completely recovered
- DO NOT leave the patient alone in the home for the first 48 hours after leaving hospital

- DO make sure that there is a nearby telephone and that the patient stays within easy reach of medical help

Telephone number to call at the hospital _____

Long term problems

Most patients recover quickly from their accident and experience no long term problems. However, some patients only develop problems after a few weeks or months. If you start to feel that things are not quite right for your child (for example, memory problems, not feeling themselves), then please contact your doctor as soon as possible so that we can check to make sure they are recovering properly.

O.6.3 Suggested written discharge advice card for carers of adults

We think that it is alright for your friend/relative/client to leave hospital now. We have checked their symptoms and they seem well on the road to recovery. When you get them home it is very unlikely that they will have any further problems. But, if any of the following symptoms do return, we suggest you bring them back to their nearest hospital emergency department as soon as possible:

- unconsciousness, or lack of full consciousness (for example, problems keeping eyes open)
- any confusion (not knowing where they are, getting things muddled up)
- any drowsiness (feeling sleepy) that goes on for longer than one hour when they would normally be wide awake
- difficulty waking the patient up
- any problems understanding or speaking
- any loss of balance or problems walking
- any weakness in one or more arms or legs
- any problems with their eyesight
- very painful headache that won't go away
- any vomiting – getting sick
- any fits (collapsing or passing out suddenly)
- clear fluid coming out of their ear or nose
- bleeding from one or more ears
- new deafness in one or more ears

Things you shouldn't worry about

They may feel some other symptoms over the next few days which should disappear in the next 2 weeks. These include a mild headache, feeling sick (without vomiting), dizziness, irritability or bad temper, problems concentrating or problems with their memory, tiredness, lack of appetite or problems sleeping. If you feel very concerned about any of these symptoms in the first few days after discharge, you should bring the patient to their doctor to talk about them. **If these problems do not go away after 2 weeks, you should bring the patient to see their doctor. We would also recommend that they seek a doctor's opinion about their ability to drive a car or motorbike.**

Things that will help the patient get better

If the patient follows this advice it should help them get better more quickly and it may help any symptoms they have to go away:

- DO have plenty of rest and avoid stressful situations
- DO NOT take any alcohol or drugs
- DO NOT take sleeping pills, sedatives or tranquilisers unless they are given by a doctor
- DO NOT play any contact sport (for example, football) for at least 3 weeks without talking to a doctor first
- DO NOT return to their normal college or work activity until they feel they have completely recovered.

- DO NOT drive a car, motorbike or bicycle or operate machinery unless they feel they have completely recovered.

Things you should do to make sure the patient is OK

- DO NOT leave the patient alone in the home for the first 48 hours after leaving hospital
- DO make sure that there is a nearby telephone and that the patient stays within easy reach of medical help

Telephone number to call at the hospital _____

Long term problems

Most patients recover quickly from their accident and experience no long term problems. However, some patients only develop problems after a few weeks or months. **If you start to feel that things are not quite right for your child or friend/relative/client (for example, memory problems, not feeling themselves), then please contact your doctor as soon as possible so that we can check to make sure they are recovering properly.**

O.7 Evidence tables

O.7.1 Abbreviations used in these evidence tables

Abbreviation	Term
AIS	Abbreviated Injury Score
BP	Blood pressure
c-spine	Cervical Spine
CCHR	Canadian CT Head Rule
CT	Computed tomography
DGH	District General Hospital
ED	Emergency department
GCS	Glasgow Coma Scale
HI	Head injury
HCT	Helical computed tomography
ICER	Incremental cost-effectiveness ratio
ICI	Intracranial injury
ICU	Intensive care unit
ISS	Injury severity score
ITT	Intention to treat
LE	Life expectancy
LoS	Length of stay (in hospital)
M/F	Male/female
MRI	Magnetic resonance imaging
N	Total number of patients randomised
NA	Not applicable
NOC	New Orleans Criteria
NR	Not reported
NS	Not significant
QALY	Quality-adjusted life years
QoL	Quality of life
RCT	Randomised controlled trial
SEM	Standard error of the mean
Sig	Statistically significant at 5%

O.7.2 Direct transport to specialist neurosciences centre vs transport to the nearest district general hospital

O.7.2.1 Clinical studies

UPDATE 2007 studies

Table 82: DiRusso 2005I

Study details	Patients	Interventions	Outcome measures	Effect size	Comments
DiRusso 2005 ¹¹² Study design: Retrospective Cohort Study Evidence level: 2+ Duration of follow-up: Data from patients admitted between April 1994	Patient group: Trauma patients younger than 20 years of age with a primary diagnosis of injury. All patients N: 49,747 Age (mean): 8.15±5.2 M/F: 31838/17909 Dropouts: NR Group 1 Non-trauma centre N: 1647 Age (mean): 7.05±5.2 M/F: 1110/537 Dropouts: NR RHISS score 2 (moderate): 54.1% RHISS score 3 (severe): 15.4% NISS: 24.8±16.4	Group 1 Patients intubated in a hospital that is not a trauma centre Group 2 Patients intubated in a trauma centre	Mortality (observed versus expected)	Group1: 16.5% Group 2: 13.3% p value: NR	Funding: Supported in part by an unrestricted grant from the Institute of Trauma and Emergency Care, New York. Limitations: Little analysis done of results so relationship between variables (causal or otherwise) is not clear. In general not much analysis was done and this makes the results as presented unclear. Also no data is given on attrition.
			Probability of Death (observed versus expected)	Group1: NS Group 2: NS	
			Mortality Stratified by NISS (New Injury Severity Score)	<15 NISS Group1: NR Group 2: NR p value: NS	
			Based on graph	15-35 NISS Group1: NR Group 2: NR p value: NS >35 NISS Group1: NR	

Study details	Patients	Interventions	Outcome measures	Effect size	Comments
until January 2002	Group 2 Trauma centre N: 1874 Age (mean): 8.0±5.4 M/F: 1196/678 Dropouts: NR RHISS score 2 (moderate): 50.1% RHISS score 3 (severe): 14.6% NISS: 24.4±16.1			Group 2: NR p value: <0.03	Additional outcomes: To adjust for degree of injury, patients were risk stratified using data on presentation including age, sex, race, systolic blood patients, respiratory rate, heart rate, New Injury Severity Score (NISS), Revised Trauma Score and Paediatric Trauma Score. The Relative Head Injury Severity Scale (RHISS) was used to stratify the severity of any head injury. Notes: Data set derived from National Paediatric Trauma Registry (NTPR)
			Mortality Stratified by Degree of Head Injury	None/Mild Group1: NR Group 2: NR p value: NS	
			Based on graph	Moderate Group1: NR Group 2: NR p value: NS	
				Severe Group1: NR Group 2: NR p value: Significant	
			NISS (New Injury Severity Score) of patients who survived to hospital discharge	Group1: 21.4±14.8 (n = 1379) Group 2: 21.6±14.4 (n = 1628) p value: NR	
RHISS (Relative Head Injury Severity Scale) of intubated patients who survived to hospital discharge	RHISS 2 Group1: 55.9 (n = 1379) Group 2: 52.8 (n = 1628) p value: NR				
	RHISS 3				

Study details	Patients	Interventions	Outcome measures	Effect size	Comments
				Group1: 9.1(n = 1379) Group 2: 9.7 (n = 1628) p value: NR	
			Odds ratios for being intubated (compared with non-intubated patients)	Group 1: 5.8 Group 2: 4.8	

Table 83: Hannan 2005

Study details	Patients	Interventions Details & duration of intervention:	Outcome measures	Effect size	Comments
Hannan 2005 ¹⁸⁴	Patient group: sub group of 2763 Head Injured patients from data set of 5419 trauma patients.	Group 1 Patients assessed via American Triage system (pre-hospital care) and referred directly to the emergency department of a regional trauma centre	Mortality Groups 1 & 2 (n=2272) vs Group 3 (n=491)	Odds ratio: 0.88, CI (0.64-1.22), p value: NS	Funding: New York State Department of Health. State Trauma Advisory Committee assisted in 'formulating' the study.
Study design: Retro-spective observational Cohort	All patients N: 2763/5419 Age (mean): NR M/F: NR Drop outs: n/a		Mortality Group 1 (n=1430) vs Groups 2 & 3 (n=1333)	Odds ratio: 0.67, CI (0.53-0.85), p value: Significant	Limitations: Description of head injured population is not detailed. Unclear, for example, what proportion has GCS>8.
Evidence level: 2+	Group 1 n = 1430 (51.38%) Age (mean): NR M/F: NR	Group 2 Patients assessed via American Triage system (pre hospital	Crude Mortality:	25.4%	Additional outcomes: AIS; Injury Severity Score; GCS; BP; pulse rate; breaths per minute.

National Clinical Guideline Centre, 2014.

Study details	Patients	Interventions Details & duration of intervention:	Outcome measures	Effect size	Comments
follow-up: 1996-1998	<p>Drop outs: NR</p> <p>Group 2 n = 842 (30.47%) Age (mean): NR M/F: NR Drop outs: NR</p> <p>Group 3 n = 491 (17.8%) Age (mean): NR M/F: NR Drop outs: NR</p>	<p>care) and referred directly an area trauma centre</p> <p>Group 3 Patients assessed via American Triage system (pre hospital care) and referred directly a non-trauma centre</p>			<p>Notes: Data obtained from New York State Trauma Registry from 1996-1998.</p> <p>'Regional', 'Area' and 'Non-trauma' are not defined in the paper, thus may not be neurosurgical units.</p> <p>Risk adjusted odds of mortality for trauma centers versus non trauma centres were calculated.</p>

Table 84: Poon 1991

Study details	Patients	Interventions	Outcome measures	Effect size	Comments
<p>Poon 1991⁴⁰²</p> <p>Study design: Case series</p> <p>Evidence level: 3</p> <p>Duration of follow-up: 5 yr prospective study</p>	<p>Patient group: patients who had an extradural haematoma requiring surgery in the neurosurgical unit between Jan 1985-Dec 1989.</p> <p>All patients N: 104</p> <p>Group 1 N: 71 Age (mean): 22 M/F: 49/22</p> <p>Group 2 N: 33 Age (mean): 20 M/F: 23/10</p>	<p>Group 1: primary or direct neurosurgical care</p> <p>Group 2: secondarily transferred from district general hospital. Transfer policy was followed, that is, patients with skull fractures and impaired conscious level, coma continuing after resuscitation, deterioration of conscious level, confusion and drowsiness for more than 8 hours, depressed fractures and basal skull fractures, are transferred immediately without question to the neurosurgical unit.</p>	<p>Mean delay (hours ± SE)= time interval between deterioration of conscious level and decompressive surgery</p> <p>Results using Glasgow Outcome Scale: Mortality: Moderate/severe disability: Good recovery: Cases of rapid deterioration of conscious level associated with evidence of</p>	<p>Group1: 0.7±1.0 Group 2: 3.2±0.5 p value:</p> <p>Group1: 3 (4%) Group 2: 8 (24%)</p> <p>Group1: 7 (10%) Group 2: 9 (27%)</p> <p>Group1: 61 (86%) Group 2: 16 (49%) X²=17.2, P≤0.0002, DF=2</p>	<p>Funding: NR</p> <p>Limitations: Possible that the patients in group 2 transferred were more severely injured than those in group 1.</p> <p>Additional outcomes: Traumatic extradural haematoma mainly occurs in young men and the incidence of lucid interval, skull fracture, posterior fossa and intradural lesions were similar between the groups.</p> <p>Majority of the extradural haematomas in the primary group were diagnosed and treated without clinical deterioration (63% vs 33% , X²=7.7, P=0.005)</p> <p>Notes:</p>

Study details	Patients	Interventions	Outcome measures	Effect size	Comments
			tentorial herniation: Prevalence:	Group1: 11/71 Group 2: 12/33 X ² =4.5, P<0.05, DF=1	
			Mortality:	Group1 (n=11): 1 Group 2 (n=12): 8	
			Moderate/severe disability:	Group1(n=11): 1 Group 2(n=12): 4	
			Good recovery:	Group1(n=11): 9 Group 2(n=12): 0 X ² =16.2, P≤0.0003, DF=2	

Economic studies

Table 85: Stevenson 2001

Study details	Patients	Interventions	Outcome measures	Effect size	Comments
Stevenson 2001 ⁴⁹¹ UK	Severe HI (AIS>2)	1. All to DGH Direct to tertiary centre if: 2. HI AIS>2 3. HI AIS>3 4. HI AIS>4 5. Non-HI AIS<4 6. Non-HI AIS<5 7. Isolated head injury 8. Intubated pre-hospital 9. Both 7. and 8. 10. Out of normal working hours	Patients that bypass the DGH	1: 0% 2: 100% 3: 78% 4: 44% 5: 89% 6: 95% 7: 75% 8: 20% 9: 5% 10: 40%	Funding: NR
Economic analysis: Not an economic analysis because it only models survival			Additional survivors per 100 HI patients compared with intervention 1 ±SEM (Far)	1: 0 2: 3.42±0.06 3: 3.54±0.06 4: 3.44±0.06 5: 3.27±0.06 6: 3.44±0.06 7: 2.76±0.05 8: 1.65±0.04 9: 1.32±0.03 10: 1.53±0.04	Notes: data were from the Keele University trauma database, Staffordshire ambulance records, published literature and expert opinion
Study design Computer simulation			Additional survivors per 100 HI patients compared with intervention 1 ±SEM (near)	1: 0 2: 4.47±0.09 3: 4.55±0.07 4: 4.29±0.08 5: 3.99±0.07 6: 4.51±0.06 7: 3.61±0.08 8: 1.91±0.08 9: 1.51±0.09 10: 1.97±0.07	
Duration of follow-up: NR			Sensitivity analysis	The results were not sensitive to one-way sensitivity analyses. Even when all of the subjective parameters were set to favour the DGH, strategies 2-6 improved survival compared with 1, by 2-3%.	
Discount rates: NA					

O.7.3 Transfer to neuroscience centre vs continued treatment at the DGH

O.7.3.1 Clinical studies

Table 86: Hartl 2006

UPDATE 2007 studies

Study details	Patients	Interventions	Outcome measures	Effect size	Comments
<p>Hartl 2006¹⁹⁰</p> <p>Study design: Cohort study</p> <p>Evidence level: 2++</p> <p>Duration of follow-up: 2 weeks</p>	<p>Patient group: 1449 with severe TBI (GCS<9) enrolled in 22 trauma centres in New York State between 2000-2004. patients were excluded on the basis of mechanism of injury, death, brain death, or otherwise not benefiting from the care on offer. Well-defined population</p> <p>All patients N: 1449</p> <p>Group 1 Direct transport N: 864 Age (mean): 36.5 M/F: NR</p>	<p>Group 1: Direct transport is defined as the transport of a patient from the scene of an injury directly to a one of the study trauma centres.</p> <p>Group 2: Indirect transport is defined as the transport of a patient from the scene of an injury to a non-trauma centre first, and then to one of the study trauma centres.</p>	<p>Patient mortality, defined as death within 2 weeks after TBI. A logistic regression analysis predicting mortality is carried out controlling for hypotension status on day one, < or >60yrs old, pupil status on day 1, and initial GCS. Admission time and times by transport status were found not to affect the results.</p>	<p>Group1: NR Group 2: NR Odds ratio: 1.48 95% CIs (1.03- 2.12) p value: 0.04</p>	<p>Funding: The New York State Department of Health (contract #C-019600)</p> <p>Limitations: No raw data is given on mortality rates in the different groups.</p> <p>Additional outcomes: Hypotension status on day one, < or >60yrs old, pupil status on day 1, and initial GCS. Admission time and time by transport status, urban vs non-urban centres.</p> <p>Notes: Well designed and reliable study.</p>

National Clinical Guideline Centre, 2014.

Study details	Patients	Interventions	Outcome measures	Effect size	Comments
	Group 2 Indirect transport N: 254 Age (mean): 34.4 M/F: NR				

Table 87: Patel 2005

Study details	Patients	Interventions	Outcome measures	Effect size	Comments
Patel 2005 ³⁹⁰	Patient group: patients injured by blunt trauma between 1996-2003 who were treated by participating hospitals in the Trauma Audit and Research Network (TARN).	Group 1 Patients who received care at a neurosurgical centre (including those who had been transferred).	Mortality Odds of death adjusted for variations in ISS, RTS and age	Group1: 1624 (35%, 34-37) Group 2: 1406 (61%, 59-63) p value = 0.000	Funding: States that funder had no role in study design, collection, analysis or interpretation or writing of report.
Study design: Retrospective Cohort, data collected prospectively.	Inclusion: GCS <9 or those intubated and ventilated on arrival, were defined as severely head injured. Exclusion: Patients over 65y with an isolated fracture of the femoral neck or pubic ramus and those with single uncomplicated limb injuries. Also patients submitted to TARN but transferred to non-participating hospital.	Group 2 Patients who received all their care in hospitals without neurosurgical facilities on site.	Standardised observed-expected survival rates for severe head injury (Ws scores)	Group1: +6% (+5% to +8%) Group 2: -10 (-9% to -12%)	Additional outcomes: This was a sub-group of a larger study which looked at mortality outcomes of HI patients compared to patients without HI.
Evidence level: 2+		Outcomes in terms of survival or death were based on assessment at discharge or 30 days (if sooner).	Mortality among sub-group of patients with isolated, non-surgical severe HI (n=894)	Group 1: 142 (26%, 22-29) Group 2: 118 (34%, 29-40) p value = 0.005	Reported trends of odds of death adjusted for case mix for patients with HI. Comparison of mortality for head injured patients and those without head injury.
Duration of follow-up: Review from 1989-2003	All patients N: 6921 Group 1 N: 4616 Transferred: 2665 (58%, 56-59) Age (median): 28 M/F: 3448/1168 ISS (median): 25	Odds of death adjusted for variations in ISS, RTS and age.			Patients at non-neurosurgical centre were less likely to have isolated HI and to have normal BP at first hospital presentation. Mortality was 26% higher for group 2 than for those treated in neurosurgical centres (p=0.000). Case mix adjusted odds of death after injury for patients with severe HI with complete physiological data who were treated in a non-neurosurgical centre was 2.15 (95% CI 1.77-2.60, AROC=0.87) times that of patients who were treated in a neurosurgical centre. Case mix adjusted odds of death was

Study details	Patients	Interventions	Outcome measures	Effect size	Comments
	<p>GCS (median): 3</p> <p>Group 2</p> <p>N: 2305</p> <p>Age (median): 34</p> <p>M/F: 1642/663</p> <p>ISS (median): 26</p> <p>GCS (median): 4</p> <p>Transferred: 302 (13%, 12-14)</p>				<p>significantly higher 1.92 (1.11-3.30) for subgroup of patients not requiring surgery. These results were limited by that nearly 50% of these patients had a component of the RTS missing.</p> <p>The investigators included a propensity score in their analysis of the benefit of neurosurgical care to keep bias to a minimum in this study.</p>
<p>Af Geijerstam 2006⁶</p> <p>Study design: Multicentre RCT</p> <p>Setting: 39 acute hospitals in Sweden</p> <p>Evidence level: 1++ or 1a</p>	<p>Patient group: Patients aged ≥6 with mild head injury who were attended for acute care at any of the participating centres were assessed. Inclusion criteria: head trauma within past 24hrs; confirmed or suspected loss of consciousness or amnesia, or both; normal results on neurological examination; GCS of 15 and no associated injuries that required admission.</p> <p>All patients</p> <p>N: 2602</p> <p>CT: n=1316 Obs: n=1286</p> <p>Age(mean): CT: 30.9 (22.1yrs) Obs: 32.0 (22.4yrs)</p>	<p>Assessment strategy under investigation: CT strategy was given to patients after randomisation. Scans were reported and interpreted according to local practice. If the scan was interpreted as normal, the patient was discharged home. Attending physicians could admit patients, despite normal findings, for other</p>	<p>Analyses of outcomes at 3mo in patients with mild head injury:</p> <p>GOS-E of 1-7 v 8 - CT (%)</p> <p>Obs in hospital (%)</p> <p>Difference (95% CI) (%)</p> <p>GOS-E of 1-6 v 7-8 - CT (%)</p> <p>Obs in hospital (%)</p> <p>Difference (95%</p>	<p>No sig difference between the groups except in 1 case (1-6 v 7-8), when CT method was superior.</p> <p>275 v 1010 (21.4)</p> <p>300 v 940 (24.2)</p> <p>-2.8 (-6.1 to 0.6)</p> <p>112 v 1173 (8.7)</p> <p>142 v 1099 (11.4)</p> <p>-2.7 (-5.1 to -0.4)</p> <p>71 v 1213 (5.5)</p> <p>76 v 1165 (6.1)</p> <p>-0.6 (-2.4 to 1.2)</p>	<p>Funding: County Council of Stockholm (Department of Research, Development and Education) and other foundations and societies.</p> <p>GOS-E was used through a postal questionnaire to assess the outcomes of all randomised patients 3 months after the injury.</p> <p>Primary end point: Dichotomised GOS-E 3 months after the injury (8 (fully recovered) v 1-7 (not fully recovered)).</p> <p>Secondary end point: Same scores dichotomised in 6 other possible ways.</p> <p>Limitations:</p>

Study details	Patients	Interventions	Outcome measures	Effect size	Comments
Duration of follow-up: 3 month follow up.	M/F (%): CT: 787(59.8) / 529(40.2) Obs: 752(58.5) / 534(41.5)	<p>medical or social reasons.</p> <p>Alternative strategy: Patients were admitted for observation strategy as inpatients according to local guidelines. The attending physicians could decide to perform CT if this seemed to be clinically necessary. Results were reported and interpreted according to local clinical practice.</p>	<p>CI) (%)</p> <p>GOS-E of 1-5 v 6-8 -</p> <p>CT (%)</p> <p>Obs in hospital (%)</p> <p>Difference (95% CI) (%)</p> <p>GOS-E of 1-4 v 5-8 -</p> <p>CT (%)</p> <p>Obs in hospital (%)</p> <p>Difference (95% CI) (%)</p> <p>GOS-E of 1-3 v 4-8 -</p> <p>CT (%)</p> <p>Obs in hospital (%)</p> <p>Difference (95% CI) (%)</p> <p>GOS-E of 1-2 v 3-8 -</p> <p>CT (%)</p>	<p>52 v 1235 (4.0)</p> <p>56 v 1187 (4.5)</p> <p>-0.5 (-2.0 to 1.1)</p> <p>12 v 1275 (0.9)</p> <p>7 v 1236 (0.6)</p> <p>0.4 (-3.0 to 1.0)</p> <p>3 v 1282 (0.4)</p> <p>4 v 1240 (0.3)</p> <p>0.1 (-0.4 to 0.5)</p> <p>5 v 1306 (0.4)</p> <p>4 v 1275 (0.3)</p> <p>0.1 (-0.4 to 0.5)</p>	<p>Some patients were lost completely to follow-up or withdrew, some were randomised twice if they had head injury twice, some had head injury more than 3 months after the first and they were counted twice, some had partial or incomplete follow up data and some randomised patients were not fully eligible. There was an error by the statistician in the preparation of the randomisation sequence for one of the centres. Not all the unused envelopes were returned after the end of the study.</p> <p>Additional outcomes: Mild head injury defined as loss of consciousness or amnesia or both in patients with normal neurological findings and a GCS score of 15 as determined by the attending physician at the patient's arrival in the emergency department after head trauma.</p> <p>A complication defined as deterioration due to the head injury that necessitated neurosurgical intervention, medical treatment or intensive care. Also included subsequent readmission because of head injury.</p>

Study details	Patients	Interventions	Outcome measures	Effect size	Comments
			Obs in hospital (%) Difference (95% CI) (%)		
			GOS-E of 1 v 2-8 - CT (%) Obs in hospital (%) Difference (95% CI) (%)		
			Deaths caused by head injury: CT Obs	1 1	
			Deaths possibly related to head injury: CT Obs	1 0	
			Deaths from other causes: CT Obs	2 4	

Study details	Patients	Interventions	Outcome measures	Effect size	Comments
			Complications on admission to ICU/neurosurgical ward during acute phase: CT Obs	2 3	
			Complications during acute phase of Neurosurgical operations: CT Obs	0 0	
			Complications during 3mo follow up of Neurosurgical operations: CT Obs	1 3	
			Readmission due to symptoms of head injury: CT		

Study details	Patients	Interventions	Outcome measures	Effect size	Comments
			<p>Obs</p> <p>A rank sum test results:</p>	<p>1</p> <p>1</p> <p>CT group was slightly better than in the obs group (p=0.062, two sided). Worst outcomes (1-4 death to severe disability) were similarly distributed in the 2 groups (4% v 4.5%). 2 people in CT group and 1 in obs group died as a probable or possible result of head injury (0.2% v 0.1%). There were 4 (0.3%) non fatal complications in the CT group and 7 (0.5%) in the obs group.</p> <p>All 3 patients in the obs group who needed surgery had a considerable delay in diagnosis and treatment (between 43-74 days after the trauma). Although 2 of these</p>	

Study details	Patients	Interventions	Outcome measures	Effect size	Comments
				patients completely recovered.	
			Outcome of not recovering completely at 3 months follow up: CT Obs Difference (% one sided 95% CI, two sided 95% CI)	275 patients (21.4%) 300 patients (24.2%) -2.8%, ≤0.03%, -6.1%- ≤0.6%) Outcome for CT is not inferior to the outcome with admission for obs.	
			Patient satisfaction (satisfied or quite satisfied with the care they had received): CT Obs	92.5% 93.8%	

Table 88: Halley 2004

Study details	Patients	Diagnostic Tool	Outcome measures	Effect size	Comments
<p>Halley 2004¹⁸²</p> <p>Study design: Prospective diagnostic study</p> <p>Setting: Large, tertiary, paediatric trauma centre in San Diego.</p> <p>Evidence level: Diagnostic study level-2+</p> <p>Duration of follow up: 4-6</p>	<p>Patient Group: Children with isolated closed head injury, history of loss of consciousness or amnesia, and GCS 13-15 who were referred for paediatric trauma evaluation and received a head CT as part of this evaluation.</p> <p>N: 98</p> <p>Age: 2-16</p> <p>M/F: 74/26 (%)</p> <p>GCS 13: 3 patients GCS 14: 19 patients GCS 15: 76 patients</p>	<p>Patients receive (non-contrast) CT as part of the evaluation and standardised physical examination</p>	<p>Correlation (Sensitivity and Specificity) of examination (normal/abnormal) with the absence/presence of CT finding of intracranial injury. Gold standard is CT scan.</p> <p>Sensitivity of positive examination (anything abnormal on the standardised examination including GCS <15):</p> <p>Specificity:</p> <p>Negative Predictive Value:</p> <p>Positive Predictive Value:</p> <p>No of CT scans with evidence of intracranial injury, including subdural haematoma, haemorrhagic contusion, subarachnoid haemorrhage, skull fracture, mass effect, pneumocephalus</p>	<p>0.69 (9/13) (CI 0.42-0.87)</p> <p>0.4 (34/85) (CI 0.30 - 0.51)</p> <p>0.89 (CI 0.76 - 0.95)</p> <p>0.15 (CI 0.08-0.26)</p> <p>13</p>	<p>Funding: N/R</p> <p>Limitations: limited sample size. 9/98 subjects not contactable. three of these patients had surgical follow up visits and were noted to be doing well. Two other subjects were observed in the hospital for 24-48hrs before discharge and were stable at the time of discharge. 4/9 subjects were lost to follow up and had no further visits to the institution.</p> <p>Of the 13 subjects with findings of intracranial injury on CT scan, two required neurosurgical intervention. One subject had an intracranial pressure monitor placed when mental status deteriorated on the ITU. 2nd subject had a depressed skull fracture elevated. Both of these subjects had abnormal clinical examinations at the time of enrolment.</p>

Study details	Patients	Diagnostic Tool	Outcome measures	Effect size	Comments
weeks					

O.7.4 Economic evidence

Table 89: Af Geijerstam 2004

Study details	Patients	Interventions	Outcome measures	Effect size	Comments
Af Geijerstam, 2004 ⁵ Country: Sweden Economic analysis: Cost analysis Study design Decision analysis Time horizon: Discharge Discount rates: Costs: NA	GCS 15, mild head injury,	Group1: CT strategy Group2: Observation strategy	Mean cost (CT, observation, ED visit, neurosurgery, from Swedish national cost database) Sensitivity analysis	Group 1: £ 300 Group 2: £ 470 The CT strategy was only cost increasing when the unit cost of CT was very high and the observation cost very low. The model was not sensitive to other parameters	Funding: N/R Notes: Costs are calculated according to Swedish national dataset Costs are presented in sterling (£) (£1 in 1998 = 13.17 SEK/1.66 US\$) Cost of in hospital observation £335; Cost of CT scan £140; % of patients admitted despite normal CT findings, 10%; % of patients given a CT scan despite observed in hospital 20%

Table 90: Fiser 1998

Study details	Patients	Interventions	Outcome measures	Effect size	Comments
Fiser 1998 ¹⁴⁵ USA	Patient group: patients with TBI undergoing both CT* and MRI N: 40 Age 28.9±3.3 M/F: 2.8:1 Initial GCS: 8.8±0.7	1: CT*+MRI 2: CT*	Diagnosis	CT but not MRI: 9/40 MRI but not CT: 24/40	Funding NR Note * There were 1.9 CT scans per patient
Economic analysis: Cost analysis			Interventions	Surgical: 12/40 Surgical (only indicated by MRI): 0/12 Medical: 31/40 Medical (only indicated by MRI): 0/31	
Study design Case series			Mean cost (imaging charges)	1: \$3,731 2 : \$1,840 p value: NR	
Duration of follow-up: NR			Cost-effectiveness (lesions detected)	1vs2: \$3,152 per extra lesion detected	
Discount rates: NA			Cost-effectiveness (change in treatment path)	CT+MRI is dominated by CT	
			Sensitivity analysis	NR	

Table 91: Hassan 2005

Study details	Patients	Interventions	Outcome measures	Effect size		Comments
Hassan 2005 ¹⁹²	Patient group: patients with head injury presenting to the ED setting	Group 1: Before implementation of NICE guideline	CT scan Number, %	A Group 1: 7/221, 3%	B Group 1: 4/276, 1.4%	Funding Trauma audit and research network
Country: UK						
Economic analysis: Cost-analysis	A. On-site Regional Neurosciences Hospital Group 1 (before) N: 221 Age (mean): 20 M/F: 68/32 % Drop outs: NA	Group 2: After implementation of NICE guideline	Mean cost difference (95%CI)*	Group 2: 20/282, 7% Mean2-Mean1 £4.91 (0.13, 9.63) p value: 0.054	Group 2: 33/351, 9% Mean2-Mean1 £8.67 (5.01,12.43) p value: <0.001	Notes * CIs were calculated by the NCC health economist
Study design Cohort study						
Duration of follow-up: 1 month (before NICE guideline implementation) and 1 month after (NICE guideline implementation)	Group 2 (after) N: 282 Age (mean): 23 M/F: 64/36 % Drop outs: NA		Skull X-ray Number, %	Group 1: 81/221, 37%	Group 1: 52/276, 19%	
				Group 2: 11/282, 4%	Group 2: 2/351, 0.6%	Other outcomes
			Mean cost difference (95%CI)*	Mean2-Mean1 £-21.94 (-26.94,-17.49) p value: <0.001	Mean2-Mean1 £-7.13 (-8.93,-5.27) p value: <0.001	The study also presented predicted resource use and cost for if the NICE guideline had been applied in the control period.
Discount rates: Costs: NA	B District General Hospital Group 1 (before) N: 276 Age (mean): 20 M/F: 66/34 % Drop outs: NA		Admission Number, %	Group 1: 21/221, 9%	Group 1: 18/276, 7%	
	Group 2 (after) N: 351 Age (mean): 25 M/F: 63/37 % Drop outs: NA			Group 2: 11/282, 4%	Group 2: 18/351 5%	
			Mean cost difference (95%CI)*	Mean2-Mean1 £-18.71 (-33.73,-3.67)	Mean2-Mean1 £-2.79 (-10.22,-4.62)	

Study details	Patients	Interventions	Outcome measures	Effect size		Comments
			Total cost	p value: 0.011 Mean2-Mean1 £-33.81	p value: 0.453 Mean2-Mean1 £-2.90	

Table 92: Norlund 2006

Study details	Patients	Interventions	Outcome measures	Effect size	Comments
Norlund 2006 ³⁵⁸ Sweden	Patient group: mild head injury	Group 1: Immediate CT	Mean Cost (£) during acute stage	Group 1: 314 (IQR:240-333) Group 2: 460 (IQR:369-467) p value: <0.001	Funding: County Council of Stockholm
Economic analysis: Cost analysis	Group 1: N: 1316 Age:>=6 M/F: NR Drop outs:2%	Group 2: Admission for observation	Mean Cost (£) during follow-up	Group 1: 174 Group 2 : 161 p value:Not signif	Limitations: See clinical review of af Geijerstam 2006 ^{6,7}
Study design RCT ⁶	Group 2 N: 1286 Age: >=6 M/F: NR Drop outs: 5%		Mean Total Cost (£) (acute stage+follow up)	Group 1: 488 Group 2 : 621 p value: <0.001	Additional outcomes: Follow-up resource use : primary care visits, emergency ward visits, sickness absence. Indirect costs. For Deaths and Glasgow Outcome Scale see clinical review
Duration of follow-up: 3 months follow up			Mean number of CT scans	Group1: 0.98 Group2: 0.08	
Discount rates: NA			Mean number of days in hospital	Group1: 0.14 Group2: 1.06	
			Sensitivity analysis	Not clearly described – a sensitivity analysis on the method of inputting missing values did not change the results	Notes: Costs have been converted from Euros (converting factor: 1€=£0.68).

Table 93: Shrivat 2006

Study details	Patients	Interventions	Outcome measures	Effect size	Comments
Shrivat 2006 ⁴⁶⁷ UK	Patients with trauma to the head attending the ED	Group 1: before implementation of NICE guideline.	Mean number of skull x-ray scans	Group 1: 0.113 Group 2: 0.004 p<0.03	Funding: NR
Economic analysis: Cost-analysis	Group 1 (2003) N: 520	Group 2: after implementation of NICE guideline.	Mean number of CT scans	Group 1: 0.02 Group 2: 0.07 p<0.01	Additional outcomes: Sensitivity and Specificity of NICE CT scan rule. Cost impact for England & Wales
Study design Retrospective cohort study	Age: <6 year: 27.7% 6-15 years:13.8% 16-64 years:42.7% >65 years:15.8%		Mean number of admissions	Group 1: 0.08 Group 2: 0.09 p=0.42	
Duration of follow-up: NR	Group 2 (2004) N: 472		Mean cost	Group 1: £263 Group 2: £340 p=0.03	
Discount rates: NA	Age: <6 year: 25.2% 6-15 years:15.9% 16-64 years:43.9% >65 years:15.0%		Sensitivity analysis	NR	
	All M/F: 57/43 % Drop outs: NA				

Table 94: Stein 2006

Study details	Patients	Interventions	Outcome measures	Effect size	Comments
Stein 2006 ⁴⁸⁸ USA Economic analysis: Cost-utility Study design Decision analysis Time horizon: Lifetime Discount rates: Costs: 3% annual rate Effects: 3% annual rate	Patient group: Patients aged 20 reporting minor traumatic brain injury, defined as an admission GCS score of 14 or 15 plus loss of consciousness.	Group 1: Selective CT and discharge for others based on the Canadian CT head rule: GCS of 14 and GCS of 15 with a high risk factor (suspected open, basilar or depressed skull fracture, multiple episodes of vomiting, age >65) Group 2: CT scan for all and ED discharge if normal Group 3: Skull radiography for all patients and discharge if no fracture Group 4: Prolonged (6 hours) ED observation and discharge if stable	Mean LE (years) Mean QALYs False positive False negative (surgical + non-surgical lesion)* Mean cost per patient 2005 US\$, direct costs based on Medicare and Medicaid reimbursements: screening + treatment** Cost-effectiveness (cost/QALY) Sensitivity analysis a) One-way sensitivity analysis	Group 1: 58.6, Group 2: 58.6 Group 3: 58.5, Group 4: 58.5 Group 5: 58.4, Group 6: 58.4 p value: NR Group 1: 28.85, Group 2: 28.85 Group 3: 28.79, Group 4: 28.79 Group 5: 28.76, Group 6: 28.76 p value: NR Group 1: 0.504, Group 2: 0 Group 3: 0.05, Group 4: 0.25 Group 5: 0.879, Group 6: 0 p value: NR Group 1: 0.017+0.02, Group 2: 0.017+0 Group 3: 0.40+0.61, Group 4: 0.371+0.25 Group 5: 1+0, Group 6: 1+1, p value: NR Group 1: \$ 1,668 (£ 1046) Group 2: \$ 1,888 (£ 1184) Group 3: \$ 2,201 (£ 1380) Group 4: \$ 2,862 (£ 1795) Group 5: \$ 3,144 (£ 1971) Group 6: \$ 4,924 (£ 3087) p value: NR Group 1 Selective CT is dominant. Only a summary was reported. QALYs and costs sensitive to the	Funding: NR Limitations: - Medicaid and Medicare reimbursements do not represent true costs - risk of cancer after radiation exposure was not considered - treatment practices and costs may be very different to NHS - the missed intracranial haematoma rates could be an underestimate (for example, fatal events outside the hospital) Notes: *surgical lesions are intracranial haematomas requiring surgery, non-surgical lesions are subarachnoid haemorrhage, cerebral oedema, or contusions ** Higher Medicare rates for complicated

National Clinical Guideline Centre, 2014.

Study details	Patients	Interventions	Outcome measures	Effect size	Comments
		Group 5: No treatment Group 6: 24-hour hospital admission (admit All)	(within 95% CI) b) Monte Carlo simulation c) ages up to 80	probability of good outcome of surgery for haematomas. If sensitivity of Selective CT is decreased by 1%, CT All becomes more effective but with an ICER of \$1.4m/QALY is not cost-effective. As age increases the results of the selective CT and CT All strategies converge.	haematomas and concussions were applied when lesions were initially missed.

O.7.5 Diagnostic tools for imaging of head injury

O.7.5.1 Studies from original 2003 guideline

Names and evidence level	Rule description	Participants	Outcomes	Specificity	Sensitivity	CT ordering rate	Prevalence	Derived using primary data	Derived using prospect. data	Validated using primary data	Validated using prospect. data	Multi-variate modelling	Follow-up	Notes
<p>Arienta et al (1997)¹⁷</p> <p>Level 2 Evidence</p> <p>Exploratory cohort study. Universally applied Gold Standard which was in most cases a</p>	<p>4 different groups:</p> <p>1. GCS=15, no loss of consciousness, currently alert and no neurologic problems, absent or minimal subgaleal swelling (this seems like a definition of 'trivial'). Patient is released into care of a family member with written instructions</p>	<p>N=10,000</p> <p>All GCS scores</p> <p>Adults and children over 6 years</p> <p>Single Italian hospital</p> <p>Patients retrospectively selected</p>	Intracranial lesions	90% specificity in their derivation set, not tested in a validation cohort	100% sensitivity in their derivation set, not tested in a validation cohort	59.2%	1.5%	Yes	No	No	No	No	99%	Retrospective review used to classify patients.

Names and evidence level	Rule description	Participants	Outcomes	Specificity	Sensitivity	CT ordering rate	Prevalence	Derived using primary data	Derived using prospect. data	Validated using primary data	Validated using prospect. data	Multi-variate modelling	Follow-up	Notes
follow up telephone call	2. GCS=15, transitory loss of consciousness, patient awake, oriented and without neurologic deficits. Amnesia, one episode of vomiting, significant subgaleal swelling. Neurologic evaluation and CT-scan. If not CT available, skull x-ray and observation for 6 or more hours if x-ray negative. CT-scan if positive skull x-ray	from clinical records – consecutive.												

Names and evidence level	Rule description	Participants	Outcomes	Specificity	Sensitivity	CT ordering rate	Prevalence	Derived using primary data	Derived using prospect. data	Validated using primary data	Validated using prospect. data	Multi-variate modelling	Follow-up	Notes
	3. GCS 9-15, impaired consciousness, uncooperative, neurologic deficits, otorrhagia/otorrhea, rhinorrhea, signs of basal fracture, seizures, penetrating or perforating wounds, patients in anticoagulant therapy, affected by coagulopathy, previous intracranial operations, epileptic or alcoholic patients. CT-scan and neurologic evaluation.													

Names and evidence level	Rule description	Participants	Outcomes	Specificity	Sensitivity	CT ordering rate	Prevalence	Derived using primary data	Derived using prospect. data	Validated using primary data	Validated using prospect. data	Multi-variate modelling	Follow-up	Notes
	4. GCS 3-8, resuscitate and CT-scan													
Borczuk et al (1995) ⁵² Level 2 evidence Well conducted study. Query over the truly consecutive nature of the patients investigated	Identified high risk factors to be: Cranial soft tissue injury Focal neurology Basal skull fracture signs Age >60	N=1448 GCS 13-15, Adults Level 1 USA trauma centre Consecutive patients who had undergone CT	CT scan Neurosurgical intervention	46.2% for rule as applied to derivation set	91.6% for rule as applied to derivation set	100%	8.2% abnormal CT, 0.8% neurosurgery	Yes	No	No	No	No	None	This paper derives a rule retrospectively and comments on its performance. These patients were selected retrospectively from the ED and Radiology records and only patients who received CT were included. However they state that they employ a

Names and evidence level	Rule description	Participants	Outcomes	Specificity	Sensitivity	CT ordering rate	Prevalence	Derived using primary data	Derived using prospect. data	Validated using primary data	Validated using prospect. data	Multi-variate modelling	Follow-up	Notes
ted														liberal and rigidly applied CT policy and therefore these patients represent a consecutive cohort of non-trivial injury
Ciccarese et al (1998) ⁷⁷ Level 2 evidence : unclear patient selection policies	Rule implemented in this study: Group 0: GCS 15, no symptoms or risk factors and the possibility of being monitored at home. Group 1: GCS 15 and one or more symptoms Group 2: GCS 14	N= 6,600 All GCS Adults Single Italian Hospital Consecutive					189 lesions found	Yes-derived from other authors reports	unclear	Yes	Yes	No		

Names and evidence level	Rule description	Participants	Outcomes	Specificity	Sensitivity	CT ordering rate	Prevalence	Derived using primary data	Derived using prospect. data	Validated using primary data	Validated using prospect. data	Multi-variate modelling	Follow-up	Notes
	<p>Group 0 may be discharged without investigations</p> <p>Group 1 and 2 should have a CT scan</p>													
<p>Cigada et al (1999)⁷⁹</p> <p>Level 3 evidence : unclear patient selection policies. Inadequate sample size.</p>	<p>Paper examines the impact of guidelines on minor head injuries in a small cohort of patients</p> <p>Paper is in Italian</p>	<p>First Cohort N=257 GCS 14-15 Adults Single Spanish hospital Consecutive</p> <p>Second cohort N=221</p>												

Names and evidence level	Rule description	Participants	Outcomes	Specificity	Sensitivity	CT ordering rate	Prevalence	Derived using primary data	Derived using prospect. data	Validated using primary data	Validated using prospect. data	Multi-variate modelling	Follow-up	Notes
		GCS 14-15 Adults Single Spanish hospital Consecutive												
Culotta et al (1996) ⁹²	This is a study of neurobehavioural outcome rather than risk of Intracranial pathology and therefore not relevant to this review													
Cummins (1992) ⁹³	Paper not relevant to this review													
Dunham et al (1996) ¹¹⁶ Level 3	They state that all minor head injuries should have CT but state that age, GCS, cranial soft tissue	N=2587 GCS13-15	ICH on CT	No rule evaluated	No rule evaluated	91.3%	7.2%	Yes	Yes	No	No	No	Follow up of non-CT patients	Paper of limited use. Non-CT patients not reported.

Names and evidence level	Rule description	Participants	Outcomes	Specificity	Sensitivity	CT ordering rate	Prevalence	Derived using primary data	Derived using prospect. data	Validated using primary data	Validated using prospect. data	Multi-variate modelling	Follow-up	Notes
evidence 100% Gold Standard of either CT or Follow-up was not applied	injury increases the risk of getting an ICH This study does not examine consistent application of a rule – certain patients did not have CT	Age over 14 Patients attending single USA trauma centre Consecutive											nts not included	
Duus et al (1994) ¹²¹ Duus et al (1993) ¹²⁰ provides the derivatio	Admit the following for observation: Confusion or aggression Impaired consciousness Focal neurological signs Skull fracture suspected	N=2204 attenders at A&E able to talk and walk even if unclear speech No	Death Need for neuro intervention	0% (all those that did not need observation received it)	98%	1%	0.2% needed neuro intervention	Yes	No	Yes	Yes	Yes in 1993 paper	100% Used routine data sources (ICD codes) to detect late ICH	Participants seem to have very low prevalence of ICH Skull radiographs not used at all

Names and evidence level	Rule description	Participants	Outcomes	Specificity	Sensitivity	CT ordering rate	Prevalence	Derived using primary data	Derived using prospect. data	Validated using primary data	Validated using prospect. data	Multi-variate modelling	Follow-up	Notes
n data Level 1 evidence Well constructed derivation and validation of rule	Alcohol intoxication History of convulsions Amnesia before impact > 15 mins loss of consciousness more than 15mins <3yrs old, with headaches and vomiting Nobody at home for observation CT-scan performed when a decline in consciousness or neurological signs is observed	information on GCS Adults and children Single Danish Hospital Consecutive patients												
Finizio et	This is a non-													

Names and evidence level	Rule description	Participants	Outcomes	Specificity	Sensitivity	CT ordering rate	Prevalence	Derived using primary data	Derived using prospect. data	Validated using primary data	Validated using prospect. data	Multi-variate modelling	Follow-up	Notes
al (1992) ¹⁴³	consecutive case series of 21 operated Extradural Haematomas in children. reporting fracture rate and location of haematoma. Therefore not relevant to the review.													
Frush et al (1998) ¹⁵⁴	Paper not relevant to this review													
Gomez et al (1996) ¹⁶⁵ Level 3 evidence No universal	Recommends CT for all GCS 13, 14 and skull X-ray for loss of consciousness and post-traumatic amnesia.	N=2484 GCS 13-15 Age over 15	CT abnormality Neurosurgery or death	No rule evaluated	No rule evaluated	7.5%	0.8% of patients had neurologic deterioration	Yes	No	No	No	Yes	No	Recommends CT in all with GCS not 15 after 4-6 hours and skull X-ray the rest but this was not tested

Names and evidence level	Rule description	Participants	Outcomes	Specificity	Sensitivity	CT ordering rate	Prevalence	Derived using primary data	Derived using prospect. data	Validated using primary data	Validated using prospect. data	Multi-variate modelling	Follow-up	Notes
Gold Standard applied	Does not test a rule and follow-up results of non-CT and non-x-ray patients is not recorded	Attendance at single Spanish hospital Consecutive					patients had surgery (0.2%) 11 patients died (0.3%)							
Gutman et al (1992) ¹⁷⁷ Level 3 evidence Non-consecutive Cohort study	This is an exploratory cohort study, which looks at a number of prognostic variables. They conclude that age, GCS, injury due to a fall, injury due to motor-vehicle occupant, pupil inequality are best ICH predictors.	N=1039 patients admitted with a head injury All GCS scores Adults >15 years old Single	Operable ICH	No rule evaluated	No rule evaluated	100%	27%	Yes	Yes	No	No	Yes	No	A prognostic study that indicates age, GCS, injury due to a fall, injury due to motor-vehicle occupant, pupillary inequality are the best ICH predictors. Results influenced by the more serious patient

Names and evidence level	Rule description	Participants	Outcomes	Specificity	Sensitivity	CT ordering rate	Prevalence	Derived using primary data	Derived using prospect. data	Validated using primary data	Validated using prospect. data	Multi-variate modelling	Follow-up	Notes
		Canadian regional trauma centre Non-consecutive as 2/3rds of patients had been referred by other hospitals therefore pre selected												profile. Results presentation is problematic. 2/3rds of patients in their study had been referred from other hospitals No follow up described after discharge
Harad et al (1992) ¹⁸⁶ Level 3	They recommend CT for all patients with minor head injury.	N=1875 patients that attended only	Outcome: abnormal CT neurosur	No rule evaluated	No rule evaluated	100%	Focus is only on those with CT	Yes	No	No	No	No	No follow up of non-CT	Study of limited relevance.

Names and evidence level	Rule description	Participants	Outcomes	Specificity	Sensitivity	CT ordering rate	Prevalence	Derived using primary data	Derived using prospect. data	Validated using primary data	Validated using prospect. data	Multi-variate modelling	Follow-up	Notes
evidence Non-consecutive study.		497 who had CT were included in the study (Criteria for CT was loss of consciousness, GCS>13 focal deficits, skull fracture, pupils) All GCS 13-15 Age of patients not	gergy										patients	

Names and evidence level	Rule description	Participants	Outcomes	Specificity	Sensitivity	CT ordering rate	Prevalence	Derived using primary data	Derived using prospect. data	Validated using primary data	Validated using prospect. data	Multi-variate modelling	Follow-up	Notes
		described – probably adults only Patients scanned at a level 1 USA trauma centre. Non-consecutive												
Haydel et al (2000) ¹⁹⁴ Level 1 evidence Well	CT for one of the following: Short-term memory deficits Intoxication Trauma Age > 60 yrs Seizure	N=520 in derivation phase, N=909 in validation phase GCS = 15	Abnormal CT-scan findings	25% (22-28%)	100% (95-100%)	76.7%	6.3%	Yes	Yes	Yes	Yes	Yes	100% - CT diagnosis	Concentrates on GCS = 15. Specificity is predictably low, with a high CT ordering rate.

National Clinical Guideline Centre, 2014.

Names and evidence level	Rule description	Participants	Outcomes	Specificity	Sensitivity	CT ordering rate	Prevalence	Derived using primary data	Derived using prospect. data	Validated using primary data	Validated using prospect. data	Multi-variate modelling	Follow-up	Notes
constructed derivation and validation of rule	Headache Vomiting Discharge if none of these present	Age 3 years and over. attenders at one trauma centre in the USA Consecutive												
Herbert et al (2000) ²⁰¹	Paper not relevant to this review													
Hofman et al (2000) ²¹¹ Level 1 evidence	This is a meta-analysis of a single variable – skull fracture, and it's value as a prognostic variable for intracranial pathology.													
Holmes et al	Their conclusion is the Miller	N=264	CT scan abnormal	No rule evaluated	No rule evaluated	100% CT	13.2% abnormal	Yes (Miller)	Yes (Miller)	Yes	Yes	No	None	This is a paper rejecting the

Names and evidence level	Rule description	Participants	Outcomes	Specificity	Sensitivity	CT ordering rate	Prevalence	Derived using primary data	Derived using prospect. data	Validated using primary data	Validated using prospect. data	Multi-variate modelling	Follow-up	Notes
(1997) ²¹⁷ Level 2 Evidence Well conducted exploratory study in GCS 14 patients with 100% CT rate	criteria, which aims to stratify the GCS 14 group into high and low risk is unsafe. The Miller criteria imply that GCS 14 patients with no soft-tissue injury and neurologic improvement can be released. They imply that all GCS 14 should be scanned.	GCS 14 only Adults Level 1 USA trauma centre Non-consecutive patients receiving CT Consecutive patients – only CT patients	lity	ed	ed	rate in this study	al CT 1.5% required neurosurgery	er))					safety of the rule, ‘the Miller Criteria’ in GCS 14 patients. The paper only focuses on patients who received CT, but is still valuable as it demonstrates the failure of these criteria to identify patients with ICH. Selected cohort of patients who had CT, but as the paper states that all patients with injuries above loss of

National Clinical Guideline Centre, 2014.

Names and evidence level	Rule description	Participants	Outcomes	Specificity	Sensitivity	CT ordering rate	Prevalence	Derived using primary data	Derived using prospect. data	Validated using primary data	Validated using prospect. data	Multi-variate modelling	Follow-up	Notes
		were studied												consciousness or post-traumatic amnesia always undergo CT and this is setting out only to investigate GCS 14 patients, it may be assumed that this is a consecutive cohort of these patients
Hsiang et al (1997) ²²¹ Level 2 evidence Well conducted	Derived rule: High-risk mild head injury is GCS 13-14 and GCS 15 with acute radiographic abnormalities. (Including CT findings) Mild head injury is the	N=1360 GCS 13-15 admitted to hospital. Patients over 11	Abnormal CT Skull fracture 6 month GOS.	72% specificity for neurosurgery after radiographic imaging that include	100% sensitivity for neurosurgery	62%	6% of patients had bad outcome	Yes	Yes	No	No	Yes	Yes. 6 month Glasgow Outcome Score in all patients	Unfortunately this rule is to predict outcome. It requires all patients to undergo CT scanning before categorising them.

Names and evidence level	Rule description	Participants	Outcomes	Specificity	Sensitivity	CT ordering rate	Prevalence	Derived using primary data	Derived using prospect. data	Validated using primary data	Validated using prospect. data	Multi-variate modelling	Follow-up	Notes
exploratory study	remaining GCS 15 patients.	years old Single Hong Kong Hospital Consecutive		s skull X-ray and/or CT scan										
Hung et al (1996) ²²² Level 3 evidence Not clear that a gold standard was universally	Rule: Patients who have either lost consciousness or have a skull fracture are at increased risk of surgically significant intracranial haematoma	N=28,500 All GCS scores Average age 35. No further details given Patients admitted	Surgically significant Intracranial haematoma neurosurgery	Specificity of loss of consciousness and absence of skull fracture in excluding ICH is 77%	Sensitivity of loss of consciousness or Skull fracture in detecting ICH is 75%	Does not give advice for CT scanning	9,038 (31.9%) had intracranial haematoma on CT. 3,348 (11.7%) had a craniotomy.	Yes	No	No	No	No	No follow up protocol was described	A patient without loss of consciousness or a skull fracture still had a risk of 5.5% for surgically significant intracranial haematoma. In GCS 13-15 group skull fracture increases the

Names and evidence level	Rule description	Participants	Outcomes	Specificity	Sensitivity	CT ordering rate	Prevalence	Derived using primary data	Derived using prospect. data	Validated using primary data	Validated using prospect. data	Multi-variate modelling	Follow-up	Notes
applied and cohort consists only of those admitted for head injury, not whole head injury population seen by the hospitals		<p>d to hospitals in Taipei city and Hualien county 1988-1992</p> <p>Consecutive hospital inpatients</p>												<p>risk of ICH by 5.5 times</p> <p>Paper of limited value</p>
<p>Ingebrigtsen et al (1995)²²⁶</p> <p>Level 3 evidence</p>	<p>Rule:</p> <p>Inpatients presenting with GCS14-15 and no neurological deficits and</p>	<p>N= 146</p> <p>GCS 14-15 and no neurological</p>	Intracranial lesions on CT	No positive cases after normal CT	No positive cases after normal CT	67% in the study	5% intracranial lesions	Yes	Yes	No	No	No	unclear	

Names and evidence level	Rule description	Participants	Outcomes	Specificity	Sensitivity	CT ordering rate	Prevalence	Derived using primary data	Derived using prospect. data	Validated using primary data	Validated using prospect. data	Multi-variate modelling	Follow-up	Notes
No universal ly applied gold standard .	normal CT, these patients can safely be discharged	deficits. 128 loss of consciou sness Adults Single Swedish Hospital Consecu tive												
Jeret et al (1993) ²³⁵ Level 2 evidence Well conduct	This is an exploratory cohort study that looks at a number of prognostic variables. The paper reports that 4 variables predict abnormal	N=712 GCS 15, with loss of consciou sness or amnesia.	Neurosu rgery, abnormal CT Abnorm al neurolog y	No rule evaluat ed	No rule evaluat ed	100%	9.4% abnormal CT rate 0.3% had neurosu rgery	Yes	Yes	No	No	Yes	100%	Authors state that GCS15 patients with a history of loss of consciousness or amnesia who have normal neurologic

National Clinical Guideline Centre, 2014.

Names and evidence level	Rule description	Participants	Outcomes	Specificity	Sensitivity	CT ordering rate	Prevalence	Derived using primary data	Derived using prospect. data	Validated using primary data	Validated using prospect. data	Multi-variate modelling	Follow-up	Notes
ed exploratory cohort study.	CT: older than 60 years, white race, basal skull fracture signs and motor vehicle or assault cause. No item or combinations could classify 95% of patients correctly. Authors conclude that CT may be indicated for all types of patients.	Adults 18 and over 2 USA hospitals Consecutive	assessed by a neurologist for all patients											signs and perform well on tests in A&E may still develop ICH. Seems to indicate that further prognostic variables required.
Kelly et al (2000) ²⁴⁷	Not relevant to this review													
Kelly et al (1988) ²⁴⁶	This Is a paper comparing a cohort of 100 patients who had CT and MR scanning. Only 3 patients had both within 3 days of injury. Conclusions are that CT are superior in the acute situation but MR													

Names and evidence level	Rule description	Participants	Outcomes	Specificity	Sensitivity	CT ordering rate	Prevalence	Derived using primary data	Derived using prospect. data	Validated using primary data	Validated using prospect. data	Multi-variate modelling	Follow-up	Notes
Level 3 evidence	scanning is superior thereafter. This paper is of interest but largely irrelevant to our clinical question regarding guidelines for acute head injury.													
Livingston et al (2000) ²⁷⁶ Level 1 evidence Well constructed validation of rule Livingston, Loder & Hunt (1991) ²⁷⁷ and Livingston, Loder, Koizel & Hunt	Rule was standard physical and neurologic exam for all patients, followed by 100% CT-scan. In this study all patients were admitted for observation, but this was for the purposes of ensuring 100% follow-up. Objective was to establish safety of early discharge.	N=2152 GCS 14-15 and minor head injury with loss of consciousness/post-traumatic amnesia Adults over 15 years old. 4 level 1	Need for neurosurgery Intracranial injury	0% (all those who did not need a test got a test)	Negative predictive value was 99.9% (99.7-100%) for need for a craniotomy	100%	13% positive CT scans	No	No	Yes	Yes	No	84% of patients completed the protocol, but the remaining 16% were followed-up and analysed as intention to treat	This is an excellent paper that demonstrates the NPV of CT-scan. A large number of in-patient bed days could possibly be saved.

Names and evidence level	Rule description	Participants	Outcomes	Specificity	Sensitivity	CT ordering rate	Prevalence	Derived using primary data	Derived using prospect. data	Validated using primary data	Validated using prospect. data	Multi-variate modelling	Follow-up	Notes
(1991) ²⁷⁸ are papers with much smaller sample sizes (N=111 and 138) that reach the same conclusions		USA trauma centres Consecutive												
Lucchi et al (1995) ²⁸²	Not relevant to this review													
Mikhail et al (1992) ³⁰⁷ Level 3 evidence	Prospective Exploratory Cohort study Concludes that Age >40, and	N=113 GCS 13-15 Adults	Intracranial injury on CT scan Neurosu	No rule proposed	No rule proposed	35 scans performed in this study	8 patients with ICH on CT (7%)	Yes	Yes	No	No	Yes	83% follow up at 4 weeks by	Underpowered study. Entry criteria of 'complaint of head injury and GCS 13-15',

Names and evidence level	Rule description	Participants	Outcomes	Specificity	Sensitivity	CT ordering rate	Prevalence	Derived using primary data	Derived using prospect. data	Validated using primary data	Validated using prospect. data	Multi-variate modelling	Follow-up	Notes
Small study with non universal gold standard	headache are associated with intracranial injury in the GCS 13-15 group. No rule proposed	only Single USA level 1 trauma centre consecutive	rgery				3 patients had neurosurgery						telephone	look very unlikely to produce a prevalence of 7% ICH. Likely that further criteria for example, loss of consciousness/post-traumatic amnesia were used to exclude trivial injury, but these were not mentioned.
Miller et al (1997) ³⁰⁹ Miller et al (1996) ³⁰⁸ is the	This paper tests rule for CT scanning in children and adults: GCS 15, with loss of consciousness and/or post-traumatic amnesia and one	N=2143 GCS 15 and history of loss of consciousness	Positive CT scan	65% spec for excluding neurosurgery.	100% for neurosurgery, but only 65% (90/138) for any CT	Reduces CT ordering by 61%	6.4% abnormal CT	Yes = 1996 paper	Yes = 1996 paper	Yes	Yes	Not in this paper	No. All patients monitored for 3 hours after injury	Paper validates a 4-point decision rule. Unfortunately their definition of positive CT was very wide so the rule's sensitivity to any positive CT

National Clinical Guideline Centre, 2014.

Names and evidence level	Rule description	Participants	Outcomes	Specificity	Sensitivity	CT ordering rate	Prevalence	Derived using primary data	Derived using prospect. data	Validated using primary data	Validated using prospect. data	Multi-variate modelling	Follow-up	Notes
<p>paper which seems to describe the rationale behind the rule</p> <p>Level 1 evidence</p> <p>Well constructed validation of rule</p>	<p>or more of:</p> <p>Severe headache</p> <p>Nausea</p> <p>Vomiting</p> <p>Clinically depressed skull fracture.</p> <p>1996 paper indicates that routine CT is unwarranted.</p>	<p>Children and adults.</p> <p>Presenting to single USA trauma centre</p> <p>Consecutive</p>		CT abnormal	abnormality								and then discharged.	is low. Also no Follow up for those discharged, and patients without loss of consciousness not included.
<p>Mohanty et al (1991)³¹⁹</p> <p>Level 3 evidence</p>	<p>No rule stated – this is a retrospective study of CT only patients. They state that “low risk” patients require</p>	<p>N=348</p> <p>GCS 13-15</p> <p>Adults</p>	Abnormal CT	No rule evaluated	No rule evaluated	Not possible to calculate	3.4% = abnormal CT	Yes	No	No	No	No	None	Focus only on CT patients.

Names and evidence level	Rule description	Participants	Outcomes	Specificity	Sensitivity	CT ordering rate	Prevalence	Derived using primary data	Derived using prospect. data	Validated using primary data	Validated using prospect. data	Multi-variate modelling	Follow-up	Notes
Non-consecutive exploratory cohort study	observation alone. Low risk seems to be: history of head trauma, 18 years or older, GCS 14-15, no decline in neurologic status, absence of any focal, sensory or motor neurologic deficit, absence of any obvious signs of basal skull fracture.	Single USA regional trauma centre Non-consecutive – patients selected from 4 month periods in 1986, 1997, 1998												
Moran et al (1994) ³²¹ Level 4 evidence Exploratory	Immediate CT-scan for all GCS13-15 with loss of consciousness or suspected skull fracture.	N=200 GCS 13-15 Adults and children	Positive CT-scan	No rule evaluated	No rule evaluated	48%	4%	No	No	No	No	No	None	Paper demonstrates the elevated risk associated with skull fracture (5/9 versus 3/192). Underpowered

Names and evidence level	Rule description	Participants	Outcomes	Specificity	Sensitivity	CT ordering rate	Prevalence	Derived using primary data	Derived using prospect. data	Validated using primary data	Validated using prospect. data	Multi-variate modelling	Follow-up	Notes
<p>ory cohort study of a specific population of those transferred by air-ambulance.</p> <p>Gold standard application seems problematic.</p>		<p>over 6 years</p> <p>Single USA hospital</p> <p>Non-consecutive. Only study of patients who were transferred to them by air-ambulance</p>												to make these conclusions.
<p>Murshid et al (1994)³³⁶</p>	<p>Conclude that skull X-ray is unnecessary and after careful</p>	<p>N=566</p> <p>GCS 13-15.</p>	<p>Abnormal CT, skull fracture</p>	<p>No rule evaluated</p>	<p>No rule evaluated</p>	<p>Not possible to calculate</p>	<p>Not possible to calculate</p>	<p>Yes</p>	<p>No</p>	<p>No</p>	<p>No</p>	<p>No</p>	<p>No follow up</p>	<p>This study is a selected group and the recommendation</p>

National Clinical Guideline Centre, 2014.

Names and evidence level	Rule description	Participants	Outcomes	Specificity	Sensitivity	CT ordering rate	Prevalence	Derived using primary data	Derived using prospect. data	Validated using primary data	Validated using prospect. data	Multi-variate modelling	Follow-up	Notes
Murshid et al (1998) ³³⁷ report very similar data Level 3 evidence Exploratory cohort study but not a consecutive cohort of those attending hospital.	examination CT should be performed. Criteria for CT not given.	All ages Single Saudi Arabian Hospital Selected cases as its only those who were admitted and admission criteria are unclear.	on skull X-ray, neurosurgery and death			ate	e							ons are of limited use to the review.
Nagy et	Rule:	N=1,170	Intracra	100% of	No	100%	3.3% (39	Yes	Yes	No	No	No	All	There is no

Names and evidence level	Rule description	Participants	Outcomes	Specificity	Sensitivity	CT ordering rate	Prevalence	Derived using primary data	Derived using prospect. data	Validated using primary data	Validated using prospect. data	Multi-variate modelling	Follow-up	Notes
al (1999) ³⁴¹ Level 2 evidence Well conducted exploratory cohort study with 100% CT rate.	All GCS 15 patients presenting with loss of consciousness/post-traumatic amnesia should undergo CT scanning. If this is normal then they are safe to be discharged	GCS 15 with loss of consciousness/post-traumatic amnesia Adults USA level 1 trauma centre Consecutive	Abnormal CT	discharge excluding ICH after negative CT	positive outcomes for admission and deterioration		patients) abnormal CT 0.4% (4 patients) had neurosurgery						patients with a normal CT were then observed for 24 hours. No other follow up after discharge	analysis of patients who do not have loss of consciousness/post-traumatic amnesia but in the specific patient group that they have selected this provides good evidence for safe discharge.
Nelson et al (1992) ³⁴⁸	This paper looks at Head CT, Thoracic CT and Abdominal CT so Head CT is a sub	N= 374 All GCS scores	Abnormal CT	No rule evaluated	No rule evaluated	71%	Not possible to calculate	Yes	Yes	No	No	No	No	Paper is not relevant

National Clinical Guideline Centre, 2014.

Names and evidence level	Rule description	Participants	Outcomes	Specificity	Sensitivity	CT ordering rate	Prevalence	Derived using primary data	Derived using prospect. data	Validated using primary data	Validated using prospect. data	Multi-variate modelling	Follow-up	Notes
Level 3 evidence This paper is not directly relevant to the review.	analysis. Rule is that GCS 15 pts can have their CT safely delayed (but must be done) Does not provide data for the non-CT patients	Adults only Level 1 USA trauma centre Consecutive blunt trauma patients of all causes					e							
Otte et al (1998) ³⁷³	This is a case report of disability after head injury													
Packard et al (1993) ³⁷⁴	Review of post-concussion syndrome, 1860's to present day. Paper not													

Names and evidence level	Rule description	Participants	Outcomes	Specificity	Sensitivity	CT ordering rate	Prevalence	Derived using primary data	Derived using prospect. data	Validated using primary data	Validated using prospect. data	Multi-variate modelling	Follow-up	Notes
	relevant to the review.													
<p>Pasman et al (1995)³⁸⁹</p> <p>Pasman et al (1992)³⁸⁸</p> <p>Level 3 evidence</p> <p>Validation cohort study but without universal gold standard</p>	<p>Retrospective cohort study to validate the Masters criteria in a Dutch setting.</p> <p>Rule: The Master's criteria are safe in the low risk category. In the high and moderate category CT scanning should be used rather than skull X-ray</p>	<p>N=1218</p> <p>All GCS groups</p> <p>Adults</p> <p>1 University hospital in Holland</p> <p>Consecutive</p>	Intracranial haematoma	37% of Low Vs (moderate or High risk) in the rule	100%	It is unclear as to what rate of CT scanning the proposed rule produces	1.6% intracranial haematoma	Yes (the Masters criteria)	Yes	Yes	No	No	No patients followed up after discharge.	<p>The patients in this study did not actually undergo management by the Masters criteria. Thus only 70% of patients in the moderate group received a skull X-ray. Also there was no follow up after discharge.</p> <p>In the moderate group they found 1 patient with an ICH but without skull</p>

Names and evidence level	Rule description	Participants	Outcomes	Specificity	Sensitivity	CT ordering rate	Prevalence	Derived using primary data	Derived using prospect. data	Validated using primary data	Validated using prospect. data	Multi-variate modelling	Follow-up	Notes
														fracture. They thus state that CT is superior to skull X-ray but do not then recommend a CT for all in the moderate category (which would give a CT ordering rate of 33%)
Porchet et al (1998) ⁴⁰³	This is a review, no original data													
Reinus et al (1994) ⁴¹²	This is not exclusively a head injury paper													
Richless et al (1993) ⁴¹⁶	This study validated the Masters criteria for use of CT in the over 2 age	N=967 GCS 15	Abnormal CT	Not clear	99.6%	14 CT scans were performed	Only 1 CT abnormality was found	Masters criteria = yes	Masters criteria = yes	Yes	Yes	No	93%	They do not specify the severity of injury of their population that

National Clinical Guideline Centre, 2014.

Names and evidence level	Rule description	Participants	Outcomes	Specificity	Sensitivity	CT ordering rate	Prevalence	Derived using primary data	Derived using prospect. data	Validated using primary data	Validated using prospect. data	Multi-variate modelling	Follow-up	Notes
Level 1 evidence Well constructed validation of rule	group Low risk: observation Moderate-risk: extended observation, consider CT, skull series may be helpful High-risk: Neurosurgical consult, emergency CT	Adults and Children over 2 years Single USA community hospital Consecutive patients				(1.4%) and 23 skull X-rays (2.4%)								is, any GCS<15. They only had one negative outcome, but Masters criteria was used safely for these thousand patients. Serious questions about the severity of the population recruited
Rosenorn et al (1991) ⁴²⁶ Level 3 evidence	Audit of practice – describes the utility of skull x-ray	N=1876 GCS 15 Adults and children	ICH development	No rule evaluated	No rule evaluated	0.5%	Not applicable	Yes	Yes	No	No	No	None	Demonstrates that there is no significant difference in the risk of development of ICH in patients with

Names and evidence level	Rule description	Participants	Outcomes	Specificity	Sensitivity	CT ordering rate	Prevalence	Derived using primary data	Derived using prospect. data	Validated using primary data	Validated using prospect. data	Multi-variate modelling	Follow-up	Notes
Exploratory cohort study but without universal applied reference standards		Single Danish Hospital Non-consecutive												<p>or without skull fracture who had a skull x-ray. Also no significant difference in ICH development between those with and without skull x-ray.</p> <p>Inconsistent application of reference standards and no follow up.</p> <p>No guidelines for skull X-ray were used and any patients discharged without a skull</p>

Names and evidence level	Rule description	Participants	Outcomes	Specificity	Sensitivity	CT ordering rate	Prevalence	Derived using primary data	Derived using prospect. data	Validated using primary data	Validated using prospect. data	Multi-variate modelling	Follow-up	Notes
														X-ray were excluded from the study.
Savastio et al (1991) ⁴³⁹ Level 3 evidence : unclear patient selection policies	High risk criteria: Basilar fractures (otorrhea, rhinorrhea, focal neurology, retroauricular haematoma), loss of consciousness Moderate risk: loss of consciousness, Amnesia, multiple trauma, possible skull penetration.	N=4262 All GCS grades Adults 1 Italian hospital Consecutive	Intracranial sequelae on CT Skull fracture		High risk criteria 100% sensitive for intracranial sequelae		0.7%	Yes	Yes	No	No	No		
Schynoll	9 variables yield	N= 264	Abnorm	No rule	No rule	100%	32	Yes	Yes	No	No	Yes	No	Identifies 9

Names and evidence level	Rule description	Participants	Outcomes	Specificity	Sensitivity	CT ordering rate	Prevalence	Derived using primary data	Derived using prospect. data	Validated using primary data	Validated using prospect. data	Multi-variate modelling	Follow-up	Notes
<p>et al (1993)⁴⁵²</p> <p>Level 3 evidence</p> <p>Exploratory Cohort study but patients were not a consecutive cohort of head injured patients.</p>	<p>high rate of abnormal CT: alcohol, amnesia, loss of consciousness, pupils, babinski, focal lesion, GCS<15, cranial nerve lesion, basilar fracture</p>	<p>All GCS grades (51 patients under GCS 15, 17 +ve CT))</p> <p>Patients, all ages</p> <p>2 USA hospitals</p> <p>Not consecutive attendees only those undergoing CT</p>	<p>al CT scan – as decided by 2 radiologists, if either feel that there is an abnormality.</p>	<p>evaluated</p>	<p>evaluated</p>		<p>positive CT, 12%</p>							<p>high yield criteria for CT scan. Does not provide data on what the sensitivity and specificity of this rule would be. 10 % of patients had none of their high risk criteria</p>

Names and evidence level	Rule description	Participants	Outcomes	Specificity	Sensitivity	CT ordering rate	Prevalence	Derived using primary data	Derived using prospect. data	Validated using primary data	Validated using prospect. data	Multi-variate modelling	Follow-up	Notes
<p>Servadei et al (1993)⁴⁵⁸</p> <p>Level 3 evidence</p> <p>Servadei et al (1995)⁴⁵⁵ reports similar results – same design problems</p> <p>Servadei, Vergoni et al (1995)⁴⁵⁹ reports a case</p>	<p>If GCS 13-15 and patient is 14 years or more then skull x-ray is performed. Positive skull fractures then receive CT-scan. If no fracture consider discharge</p> <p>Children under 14 years are referred to a regional hospital with 24-hour CT for observation and/or CT.</p>	<p>N=423 adults and 83 children in protocol free period</p> <p>N=859 adults and 191 children in period with protocol</p> <p>Adults included if GCS 13-15. And brief loss of</p>	<p>Positive CT-scan. Mortality (followed up through routine sources)</p>	<p>Not possible to produce for this design</p> <p>But of 859 patients the specificity of admission vs non admission is 34% 23</p>	<p>Not possible to produce for this design</p> <p>Although for the 859 patients in the protocol driven group 2 out of 72 abnormal CTs were missed</p>	<p>Overall population results not reported but with protocol 30% of patients had CT scan 23</p>	<p>Overall population results not reported but of 859 patients reported 72 positive examinations found = 8% 23</p>	<p>Yes in their 1988 Paper</p>	<p>Yes in their 1988 paper</p>	<p>Yes</p>	<p>No</p>	<p>No</p>	<p>Not clear but they report 2 cases of readmission that had abnormal CT scans on rescanning – cerebral contusions, and a</p>	<p>Essential figures not included. Focus almost entirely on cases.</p>

Names and evidence level	Rule description	Participants	Outcomes	Specificity	Sensitivity	CT ordering rate	Prevalence	Derived using primary data	Derived using prospect. data	Validated using primary data	Validated using prospect. data	Multi-variate modelling	Follow-up	Notes
<p>series</p> <p>Servadei et al (1989 – reports a case series)⁴⁵⁶</p> <p>Level 3 evidence as unclear reference standards</p>		<p>consciousness, or skull fracture</p> <p>Children included if symptomatic but not if in stupor, coma or focal neurology. Asymptomatic children not included</p> <p>Attendance at</p>			<p>Sensitivity = 97% 23</p>								<p>4x5cm frontal contusion.</p> <p>– both treated conservatively</p> <p>Survey of deaths also done</p> <p>– none found</p>	

Names and evidence level	Rule description	Participants	Outcomes	Specificity	Sensitivity	CT ordering rate	Prevalence	Derived using primary data	Derived using prospect. data	Validated using primary data	Validated using prospect. data	Multi-variate modelling	Follow-up	Notes
		single Italian Hospital Probably non consecutive												
Servadei F, Teasdale GM et al (2001) ⁴⁵⁷ Review	<p>This is a review on behalf of the WHO Neurotrauma Collaborating Center Their recommendations are as follows :</p> <p>Low risk mild injury patients are those with a Glasgow Coma Score (GCS) of 15 and without a history of loss of consciousness, amnesia, vomiting, or diffuse headache. The risk of intracranial hematoma requiring surgical evacuation is definitively less than 0.1:100. These patients can be sent home with written recommendations</p> <p>Medium risk mild injury patients have a GCS of 15 and one or more of the following symptoms: loss of consciousness, amnesia, vomiting, or diffuse headache. The risk of intracranial hematoma requiring surgical evacuation is in the range of 1-3:100. Where there is one computed tomography (CT) scanner available in an area for 100,000 people or less, a CT scan should be obtained for such patients. If CT scanning is not so readily available, adults should have a skull x-ray and, if this shows a fracture, should be moved to the 'high-risk' category and undergo CT scanning</p> <p>High-risk mild head injury patients are those with an admission GCS of 14 or 15, with a skull fracture and/or neurological deficits. The risk of intracranial hematoma requiring surgical evacuation is in the range 6-10:100. If a CT scan is available for 500,000 people or less, this examination must be obtained. Patients with one of the following risk factors - coagulopathy, drug or alcohol consumption, previous neurosurgical procedures, pretrauma epilepsy, or age over 60 years - are included in the high-risk group independent of the clinical presentation</p>													

Names and evidence level	Rule description	Participants	Outcomes	Specificity	Sensitivity	CT ordering rate	Prevalence	Derived using primary data	Derived using prospect. data	Validated using primary data	Validated using prospect. data	Multi-variate modelling	Follow-up	Notes
Shaabat et al (2001) ⁴⁶⁰ , ₄₆₀	Not relevant to this review													
Shackford et al (1992) ⁴⁶¹ Level 3 evidence Exploratory cohort study with inconsistent reference standards	No rule stated – the paper is more of an audit of current practice, although they do estimate the sensitivity and specificity of a CT alone strategy. They recommend 100% CT.	N=2766 GCS 13-15 Adults and children 7 USA trauma centres During study period 9626 patients were seen	Relevant positive CT (excluding fracture) Craniotomy	Not possible to produce for this design	Not possible to produce for this design	78.3%	17% relevant positive CT (468/2766) 9% intervention rate (256/2766)	Yes	No	No	No	No	None Follow up protocol not stated but 3 patients who were readmitted are described so some	This is an entirely retrospective study used to derive a 100% CT rule. Clinicians reviewing notes, which are most likely of dubious quality. Very high CT abnormality rate

Names and evidence level	Rule description	Participants	Outcomes	Specificity	Sensitivity	CT ordering rate	Prevalence	Derived using primary data	Derived using prospect. data	Validated using primary data	Validated using prospect. data	Multi-variate modelling	Follow-up	Notes
		with any level of head injury. 2766 were selected as minor therefore consecutive but only with strict criteria for MHI											form of checking for readmission may have been done	
Sharma et al (1994) ⁴⁶⁴ Level 3 evidence Validation	Retrospective validation cohort study. Management Protocol: Admission:	N=312 All GCS grades Adults and children	Abnormality on CT scan Referral to neurosurgery	Not reliably obtainable	Not reliably obtainable	16% of the 87 children	22 of 87 abnormal CT 25% ICH or cerebral oedema	No	No	Yes	No	No	All patients with 'residual deficit' or on	None of those admitted or discharged were followed up if asymptomatic at discharge. Only 83 scans out of 312

National Clinical Guideline Centre, 2014.

Names and evidence level	Rule description	Participants	Outcomes	Specificity	Sensitivity	CT ordering rate	Prevalence	Derived using primary data	Derived using prospect. data	Validated using primary data	Validated using prospect. data	Multi-variate modelling	Follow-up	Notes
n cohort study but with inconsistent reference standards	History of trauma and, loss of consciousness, bleeding from ear, nose or mouth, vomiting or skull fracture on skull X-rays CT scan: GCS<8 with no eye opening for 6 hours, deteriorating sensorium, focal pupil or limb signs, coma, unresponsive to verbal commands for >24 hours, seizures, hyperpyrexia and neck rigidity.	Attending 1 Indian Hospital Consecutive patients											anti convulsants seen.	were performed in total so no reliable gold standard.
Stein	CT-scan for all	N=1538	Intracra	0%	100%	100%	13%	No	No	Yes	No	No	100%	Prevalence rate

Names and evidence level	Rule description	Participants	Outcomes	Specificity	Sensitivity	CT ordering rate	Prevalence	Derived using primary data	Derived using prospect. data	Validated using primary data	Validated using prospect. data	Multi-variate modelling	Follow-up	Notes
<p>and Ross (1992)⁴⁸⁶</p> <p>An earlier paper by Stein and Ross¹² appears in 1990 – seems to be the same patients</p> <p>Level 1 evidence</p> <p>Well constructed</p>	<p>patients with any loss of consciousness or amnesia</p>	<p>Closed head injury admissions</p> <p>GCS 13-15</p> <p>No focal neurologic deficits</p> <p>Adults only</p> <p>Admissions to a single American trauma centre</p>	<p>nial lesions on CT</p>					<p>(routine practice)</p>	<p>(routine practice)</p>		<p>(review of notes)</p>		<p>CT-diagnosis</p>	<p>is quite high – implies a more severe population</p>

Names and evidence level	Rule description	Participants	Outcomes	Specificity	Sensitivity	CT ordering rate	Prevalence	Derived using primary data	Derived using prospect. data	Validated using primary data	Validated using prospect. data	Multi-variate modelling	Follow-up	Notes
validation of rule		Consecutive												
Stein and Spettel (1993) ⁴⁸⁷ This is a univariate analysis of neurological assessment and therefore of limited use in our search for a decision rule	Concludes that neurological assessment either by GCS or by Reaction Level Scale (RLS85) is not adequate to determine risk of ICH. Recommends CT for all patients with loss of consciousness / post-traumatic amnesia	N=685 GCS 13-15. Age range not stated? Adults only Patients who had CT at single trauma centre. USA. Consecutive patients.	Intracranial abnormality on CT scan	No rule evaluated	No rule evaluated	100%	18% ICH	Yes	No	No	No	No	No	Retrospective study with 100% CT rate reporting the inability of neurological assessment to predict ICH. No other symptoms or signs were extracted from case records. Study is of limited use in constructing a comprehensive rule for CT scanning.

Names and evidence level	Rule description	Participants	Outcomes	Specificity	Sensitivity	CT ordering rate	Prevalence	Derived using primary data	Derived using prospect. data	Validated using primary data	Validated using prospect. data	Multi-variate modelling	Follow-up	Notes
Stein et al (1995) ⁴⁸² Level 2 evidence Well constructed derivation of rule Stein et al (1996) ⁴⁸¹ This is a review and data	Paediatric Retrospective Cohort study. DERIVED RULE: Minimal closed head injury (CHI) : No loss of consciousness or post-traumatic amnesia, GCS 15 Discharge with no CT if none of the following risk factors : -Extracranial injuries -Age<2 with repeated vomiting	N = 2,533 fully reviewed from a population of 12,809 from whom some data was obtained All GCS scores Children under 19 years old Single USA university	Intracranial lesion, Neuro surgery Glasgow Outcome Score at 6 months	81% sensitivity of rule High sensitivity if you use 12559 as a denominator. To use this denominator we must be satisfied that the follow up of the 10,276 minimal	100%	Proposed rule would lead to 7% CT ordering rate.	2.6% of mild head injuries needed neuro-surgery. (1.9% of GCS 15) 0.01% neuro-surgery for Minimal head injury (1 case in 11,907)	Yes	No	No	No	No	All mod, mild and minimal HI with high risk factors were followed up at 48H and 6 weeks (80% successful F/U) Of the 10,276 minim	They state that during the study period all children with mild and moderate CHI had a CT scan and that 'many' of those with a minimal CHI had a CT scan. It is unclear as to what proportion of patients were seen according to their rule, although the implication is that they all were. Follow up of the 10,276 was retrospective

Names and evidence level	Rule description	Participants	Outcomes	Specificity	Sensitivity	CT ordering rate	Prevalence	Derived using primary data	Derived using prospect. data	Validated using primary data	Validated using prospect. data	Multi-variate modelling	Follow-up	Notes
extraction of past papers	-No reliable transportation or reliable observation at Home - Anticoagulationn or medical condition increasing risk -Palpable depressed skull fracture. 1 or more seizures Suspected child abuse Persistent headache, nausea, vomiting etc. If risk factor present admit and CT if	hospital Consecutive children assessed , then defined population fully reviewed		head injury patients was adequate (see notes)									al CHI who were discharged no F/U protocol was described but it was stated that none deteriorated, were readmitted or needed	and seems to have consisted of checking for readmission, or surgery at their institution.

Names and evidence level	Rule description	Participants	Outcomes	Specificity	Sensitivity	CT ordering rate	Prevalence	Derived using primary data	Derived using prospect. data	Validated using primary data	Validated using prospect. data	Multi-variate modelling	Follow-up	Notes
	<p>symptoms persist.</p> <p>Mild CHI:</p> <p>GCS14 or GCS15 and LOC <5 mins, event amnesia</p> <p>- CT scan all patients. If neg and none of above high risk factors discharge.</p> <p>Moderate CHI:</p> <p>loss of consciousness > 5mins, GCS 9-13 or focal neurology.</p>												<p>neuro surgery.</p> <p>A survey of a sample of 734 of these patients was performed (78% F/U success) to look at morbidity in this minim</p>	

Names and evidence level	Rule description	Participants	Outcomes	Specificity	Sensitivity	CT ordering rate	Prevalence	Derived using primary data	Derived using prospect. data	Validated using primary data	Validated using prospect. data	Multi-variate modelling	Follow-up	Notes
	- Immediate CT and admission												al CHI group	
Stiell et al (2001) ^{497,498} Canadian CT Head Rule (5 and 7 variables) Level 2 evidence Well constructed derivation of rule	A five variable rule has been developed when the outcome is need for neurological intervention. Immediate CT for all patients with the following: GCS<15; Open or depressed skull fracture; Basal skull fracture signs; 2 or more vomit; Age more than 64 years. Non-CT eligible discharged. A seven variable	N = 3121 GCS 13-15, with loss of consciousness/post-traumatic amnesia and history of trauma, and no signs of penetrating trauma, or seizure	Clinically important brain injury (CIBI) for seven variable rule. Need for neurosurgical intervention for five variable rule.	49.6% (48-51%) for the 7 variable rule 68.7% (67-70%) for the 5 variable rule	98.4% (96-99%) for the 7 variable rule 100% (92-100%) for the 5 variable rule	54.3% for the 7 variable rule 32.2% for the five variable rule	8% had CIBI 1% needed neurosurgical intervention NPV: 99.7%	Yes	Yes	Yes (in a sub-sample)	Yes (in a sub-sample)	Yes	67% had CT-scan 21% clinically followed up by telephone at 14 days. 363 patients not followed up (12%)	Assumption is that 'trivial injuries' are discharged (no loss of consciousness, amnesia, disorientation); all GCS<13 would receive immediate CT, even though rules not developed for this group; clinical follow-up is not as sensitive as CT (estimated that up to 13% of CIBI could have been missed).

National Clinical Guideline Centre, 2014.

Names and evidence level	Rule description	Participants	Outcomes	Specificity	Sensitivity	CT ordering rate	Prevalence	Derived using primary data	Derived using prospect. data	Validated using primary data	Validated using prospect. data	Multi-variate modelling	Follow-up	Notes
	rule has also been developed when clinically important brain injury is the intended outcome. The rule is as above plus: Amnesia before impact > 30min; Dangerous mechanism (motor vehicle ejection, pedestrian struck by motor vehicle, fall from > 3 ft or 5 stairs)	Age >16 yrs Patients attending 10 Canadian emergency departments Consecutive												<p>These rules are in the process of being validated. The large sample size gives greater confidence in the preliminary validation carried out on the derivation sample.</p> <p>1358 eligible patients were not enrolled (logistics)</p> <p>Note: this rule does not include headache as a variable, which</p>

Names and evidence level	Rule description	Participants	Outcomes	Specificity	Sensitivity	CT ordering rate	Prevalence	Derived using primary data	Derived using prospect. data	Validated using primary data	Validated using prospect. data	Multi-variate modelling	Follow-up	Notes
														some UK clinicians may find unacceptable. This was due to the fact that their data collection only recorded presence or absence of headache and did not divide this category into mild moderate and severe headache, therefore significance was not found.
Sturloni et al (1997) ⁵⁰⁰	Paper not relevant to the review.													
Taheri et	Exploratory	N=310	ICH	No rule	No rule	55%	23%	Yes	No	No	No	No	None	Small study.

Names and evidence level	Rule description	Participants	Outcomes	Specificity	Sensitivity	CT ordering rate	Prevalence	Derived using primary data	Derived using prospect. data	Validated using primary data	Validated using prospect. data	Multi-variate modelling	Follow-up	Notes
al (1993) ⁵⁰³ Level 3 evidence Retrospective exploratory cohort study with no universal gold standard	cohort study designed to identify those patients with minor head injuries that can be safely discharged from A&E. They state that: GCS 15, no deficit except amnesia, no signs of intoxication, no evidence of basal skull fracture on clinical exam, no linear fracture on skull x-ray.	fully assessed out of 407 who were reviewed GCS 15 Adults over 14 years old Single USA trauma centre Consecutive		evaluated	evaluated									Conclusion is that patients meeting certain criteria can be safely discharged, but no follow up data. Retrospective study, and highly selected patient group.
Teasdale et al (1990) ⁵⁰⁸	Fully conscious patients without any indication	A&E PATIENT S:	Need for neurosurgery	No rule evaluated	No rule evaluated	Proposed rule	Not possible to	Yes	No	No	No	Yes	Not relevant	This retrospective design is a

Names and evidence level	Rule description	Participants	Outcomes	Specificity	Sensitivity	CT ordering rate	Prevalence	Derived using primary data	Derived using prospect. data	Validated using primary data	Validated using prospect. data	Multi-variate modelling	Follow-up	Notes
Level 4 evidence Case-control study	for skull x-ray: discharged (criteria for a Skull X-ray are not given) Negative skull x-ray patients: discharged Positive skull x-ray patients: urgent CT	N=8406 All GCS scores Adults, and children under 14 compared as 2 groups 3557 from all hospitals in Scotland in a 2 week period in 1974, 768 pts from Glasgow,				would lead to 7% CT ordering rate	calculate for this design.							case-control comparison. The authors indicate that historical data point to the role of skull fracture and history of altered consciousness as key risk factors. In fully conscious adults they state that the risk goes from 1 in 31,370 for someone with neither skull fracture nor history of loss of consciousness to 1 in 29 for someone with

Names and evidence level	Rule description	Participants	Outcomes	Specificity	Sensitivity	CT ordering rate	Prevalence	Derived using primary data	Derived using prospect. data	Validated using primary data	Validated using prospect. data	Multi-variate modelling	Follow-up	Notes
	recovered	710 pts from Teesside , 3371 pts from Monklans Non-consecutive NEUROSURGERY PATIENTS: N=1007 All GCS scores Adults, and												both risk factors. Risk factors are said to be the same for children.

Names and evidence level	Rule description	Participants	Outcomes	Specificity	Sensitivity	CT ordering rate	Prevalence	Derived using primary data	Derived using prospect. data	Validated using primary data	Validated using prospect. data	Multi-variate modelling	Follow-up	Notes
		children under 14 compared as 2 groups Patients from Glasgow neuro-surgical unit from 1974-1984 Consecutive patients with evacuation of haematoma												
Tsai et al	Rule proposed:	N=186	Abnorm	Unable	Unable	4%	22%	Yes	No	No	No	No	Yes –	The Patient

Names and evidence level	Rule description	Participants	Outcomes	Specificity	Sensitivity	CT ordering rate	Prevalence	Derived using primary data	Derived using prospect. data	Validated using primary data	Validated using prospect. data	Multi-variate modelling	Follow-up	Notes
(1994) ⁵²¹ Level 4 evidence Retrospective exploratory cohort study with inconsistent reference standards	CT scan for loss of consciousness/post-traumatic amnesia. Progressive neurologic abnormality, GCS <13. People with normal CT can go home.	GCS 13-15 Adults Attending 1 Taiwanese Hospital, Non-consecutive,	al CT scan Neurosurgery	to calculate as paper states that there were asymptomatic and delayed onset haematomas but did not give any further details of numbers	to calculate as paper states that there were asymptomatic and delayed onset haematomas but did not give any further details of numbers		abnormal CT 6.5% neurosurgery						but no details given other than stating: "This recommendation is not foolproof asymptomatic and delayed onset haematom	group was highly selected: from 4760 records, 186 patients were found who were GCS 13-15 and had a CT scan requested. Criteria for CT were loss of consciousness/post-traumatic amnesia, focal neurology, depressed or open skull fracture, pupil inequality, deterioration in mental status. The reporting of results is incomplete

Names and evidence level	Rule description	Participants	Outcomes	Specificity	Sensitivity	CT ordering rate	Prevalence	Derived using primary data	Derived using prospect. data	Validated using primary data	Validated using prospect. data	Multi-variate modelling	Follow-up	Notes
													as did occur “	with regard to the total number of haematomas found in the study period.
Uchino et al (2001) ⁵²⁶ Level 3 evidence Small retrospective exploratory cohort study	No rule evaluated. This paper examines the utility of GCS in classifying patients. All patients had CT or MRI.	N=90 GCS 13-15, Adults aged >13 years Single Japanese Hospital Consecutive	Abnormal CT	No rule evaluated	No rule evaluated	100%	14%	Yes	Yes	No	No	No	No	This is a small study that attempts to demonstrate that GCS alone cannot rule out ICH. They also conclude that MRI should be performed on patients with GCS 14, as parenchymal lesions cannot be imaged with CT. Study is underpowered for these conclusions.

National Clinical Guideline Centre, 2014.

Names and evidence level	Rule description	Participants	Outcomes	Specificity	Sensitivity	CT ordering rate	Prevalence	Derived using primary data	Derived using prospect. data	Validated using primary data	Validated using prospect. data	Multi-variate modelling	Follow-up	Notes
<p>Vilke et al (2000)⁵²⁸</p> <p>Level 3 evidence</p> <p>Very small non consecutive study</p>	<p>Exploratory Cohort study</p> <p>3 Patients had ICH, 2 Had abnormal neurology but one Had no neurology. Conclusion is that full neurological examination is not adequate to exclude ICH.</p>	<p>N=58.</p> <p>GCS 15 with loss of consciousness/post-traumatic amnesia</p> <p>Sober adults</p> <p>Single Canadian hospital</p> <p>Non-consecutive</p>	<p>Acute intracranial injury on CT</p>	61%	66% sensitivity of neurological exam in predicting ICH	100%	5% ICH	Yes	Yes	No	No	No	No	Underpowered study and therefore of limited value

Names and evidence level	Rule description	Participants	Outcomes	Specificity	Sensitivity	CT ordering rate	Prevalence	Derived using primary data	Derived using prospect. data	Validated using primary data	Validated using prospect. data	Multi-variate modelling	Follow-up	Notes
Viola et al (2000) ⁵²⁹ Tomei et al (1996) ⁵¹⁵ Level 3 evidence Inconsistent reference standards	Group 0: GCS 15, no loss of consciousness/amnesia/headache/vomiting, no other risk factors should be discharged Group 1: GCS 15 one or more from loss of consciousness/amnesia/headache/vomiting, no other risk factors need radiology and clinical observation Group 2: GCS 14 with or without loss of consciousness/amnesia/headach	N=4536 GCS 14-15 Adults and en over 12 years old Single Italian Hospital Consecutive	Abnormal CT scan	86% (3864/4492)	100%	19%	1.9%	No	No	Yes	Yes	4078 patients were clinically observed for 6 to 12 hours and then discharged, without any further follow up.	Admitted patients were reviewed within 6 months	No follow-up of non-admitted patients from this paper, therefore specificity is open to question.

Names and evidence level	Rule description	Participants	Outcomes	Specificity	Sensitivity	CT ordering rate	Prevalence	Derived using primary data	Derived using prospect. data	Validated using primary data	Validated using prospect. data	Multi-variate modelling	Follow-up	Notes
	<p>e/vomiting and with or without other risk factors need radiology and clinical observation and admission</p> <p>Group 0-1R: GCS 15 with or without loss of consciousness/amnesia/headache/vomiting, but with other risk factors. Treatment of patients not specified in paper.</p> <p>NB - Risk factors here refers to coagulopathy/alcohol/epilepsy/ab</p>													

Names and evidence level	Rule description	Participants	Outcomes	Specificity	Sensitivity	CT ordering rate	Prevalence	Derived using primary data	Derived using prospect. data	Validated using primary data	Validated using prospect. data	Multi-variate modelling	Follow-up	Notes
	use of drugs/previous neurosurgical operations/disabled elderly patients.													

O.7.6 Clinical prediction rules for head CT selection: non-adults

O.7.6.1 Studies from original 2003 guideline

Names and evidence level	Rule description	Participants	Outcomes	Specificity	Sensitivity	CT ordering rate	Prevalence	Derived using primary data	Derived using prospect. data	Validated using primary data	Validated using prospect. data	Multi-variate modelling	Follow-up	Notes
Adams et al (2001) ² Level 3 evidence Patients identified from a trauma database, no universal gold standard of CT or follow up	They recommend skull X-ray and CT on all children but if GCS 15 they do not need to be admitted	N=1033 GCS 15 and admitted for head injury Children under 18 Patients entered in the National Pediatric Trauma registry USA	Abnormal CT-scan	No rule evaluated	No rule evaluated	37.4%	No neurosurgical interventions out of 1033 patients	Yes	No	No	No	No	No follow up	Very small subset of patients with GCS and no loss of consciousness.

Names and evidence level	Rule description	Participants	Outcomes	Specificity	Sensitivity	CT ordering rate	Prevalence	Derived using primary data	Derived using prospect. data	Validated using primary data	Validated using prospect. data	Multi-variate modelling	Follow-up	Notes
		Non-consecutive												
Benito-Fernandez et al (1998) ³⁹ Level 3 evidence, inconsistent reference standards	Children who are neurologically normal and without symptoms may be discharged. Otherwise children should have CT scan.	N=1,128 GCS 14-15. Children aged 0-14, Single Spanish centre Consecutive.	Traumatic intracranial abnormalities on CT.	No rule evaluated	No rule evaluated		1% ICH (11 patients) 4 required surgery. 4 GCS 15 children had ICH.	Yes	Yes	No	No	No		
Chan, Yue et al (1990) ⁷⁵ Chan,	Children with either a skull fracture or a history of impaired	RETROSPECTIVE COHORT :	ICH development	No rule evaluated	No rule evaluated	Not clear	1.3% = ICH in retrospective cohort	Yes	No	Yes	Yes	Yes	In retrospective cohort	This study follows the same lines as the Teasdale study —

Names and evidence level	Rule description	Participants	Outcomes	Specificity	Sensitivity	CT ordering rate	Prevalence	Derived using primary data	Derived using prospect. data	Validated using primary data	Validated using prospect. data	Multi-variate modelling	Follow-up	Notes
<p>Mann et al (1990)⁷⁴</p> <p>Level 2 evidence</p> <p>Well conducted exploratory study. Prospective cohort does not have universally applied gold standard</p>	<p>consciousness have an elevated risk of ICH and should have immediate CT.</p> <p>Children with a history of impaired consciousness alone should have immediate CT.</p>	<p>N=12072</p> <p>All GCS scores</p> <p>Children under 16 years</p> <p>Single Hong Kong university hospital</p> <p>Consecutive</p> <p>PROSPECTIVE COHORT</p>					1.1% in prospective cohort						<p>100% admission rate, then no follow up after discharge.</p> <p>Prospective cohort : 35% admitted and followed up at 3 months – others</p>	<p>indicating the importance of skull fracture and loss of consciousness. Validation study has low follow-up rate. The prevalence rate is very low – leading to large confidence intervals.</p>

Names and evidence level	Rule description	Participants	Outcomes	Specificity	Sensitivity	CT ordering rate	Prevalence	Derived using primary data	Derived using prospect. data	Validated using primary data	Validated using prospect. data	Multi-variate modelling	Follow-up	Notes
		N=1178 Adolescents (11-15 years) All GCS scores but only 21pts less than GCS 15 (6 ICH) Single Hong Kong university hospital Consecutive											not followed up	
Davis et	Recommends all	N=185,	ICH on	No rule	No rule	CT	Not	Yes	No	No	No	Yes in	No	Methodologic

National Clinical Guideline Centre, 2014.

Names and evidence level	Rule description	Participants	Outcomes	Specificity	Sensitivity	CT ordering rate	Prevalence	Derived using primary data	Derived using prospect. data	Validated using primary data	Validated using prospect. data	Multi-variate modelling	Follow-up	Notes
<p>al (1994)¹⁰¹</p> <p>Davis, Hughes et al (1995)¹⁰⁰</p> <p>Level 3 evidence</p> <p>Their strict inclusion criteria and the necessity for the patient to have had a CT means that these</p>	<p>GCS 15 children over 2 year s old with loss of consciousness, neurologically normal may be discharged without CT</p>	<p>retrospective children in 1994 paper.</p> <p>N=400 children</p> <p>GCS 13-15 and normal CT</p> <p>Children at two USA hospitals</p> <p>non consecutive</p>	<p>CT in 1994 paper</p> <p>Readmission and neurosurgery in 1995 paper</p>	<p>evaluate d</p>	<p>evaluat ed</p>	<p>rate was 100% in this study.</p> <p>Rule says 73% ordering rate</p>	<p>possible to evaluate – focus is on cases</p>					<p>1994 paper</p>		<p>al error: 2235 patients notes were looked through to find the 185 patients used for the study - highly selected group</p>

Names and evidence level	Rule description	Participants	Outcomes	Specificity	Sensitivity	CT ordering rate	Prevalence	Derived using primary data	Derived using prospect. data	Validated using primary data	Validated using prospect. data	Multi-variate modelling	Follow-up	Notes
patients cannot be considered to be truly consecutive.														
Dietrich et al (1993) ¹⁰⁸ Level 3 evidence Only patients selected for CT were included in this study, therefore	Recommends CT for all GCS<15, and all GCS 15 if there are any symptoms (that is, loss of consciousness, nausea, vomiting, seizures etc)	N=322 All GCS scores (50 under GCS 15) Children aged 0-16 years Single USA children's trauma centre	ICI on CT scan	No rule evaluated	No rule evaluated	100%	12%	Yes	Yes	No	No	No	None	Large study in children concluding that there are no reliable rules to safely exclude some children from scanning. Non-consecutive patients

Names and evidence level	Rule description	Participants	Outcomes	Specificity	Sensitivity	CT ordering rate	Prevalence	Derived using primary data	Derived using prospect. data	Validated using primary data	Validated using prospect. data	Multi-variate modelling	Follow-up	Notes
e non-consecutive.		Non-consecutive patients												
Greenes et al (1999) ¹⁷¹ Level 2 evidence Well conducted exploratory cohort study	All infants under 3 months need radiographic imaging (CT or skull X-ray for haematoma only). 3 mths to 2 years, if asymptomatic and no scalp haematoma discharge	N=608 All GCS scores Infants under 2 years old – patients Single USA paediatric trauma centre	ICI defined on CT	No rule evaluated	No rule evaluated	31%	5% had ICH	Yes	Yes	No	No	No	Yes all followed up by telephone	Very big study in the under 2-age group.

Names and evidence level	Rule description	Participants	Outcomes	Specificity	Sensitivity	CT ordering rate	Prevalence	Derived using primary data	Derived using prospect. data	Validated using primary data	Validated using prospect. data	Multi-variate modelling	Follow-up	Notes
		Consecutive patients												
Greenes et al (2001) ¹⁷² Level 2 evidence Well conducted exploratory cohort study	Exploratory Cohort study of consecutive asymptomatic infants attending single paediatric trauma centre. Patients excluded if any of the following: loss of consciousness, lethargy, irritability, depressed mental status, bulging fontanel, focal neurology, reduced GCS, Palpable skull fracture	N= 422 All GCS scores Age 0-24 months. Single USA paediatric trauma centre Consecutive patients	Intracranial Injury, defined as cerebral contusion, cerebral oedema, or intracranial haematoma. Skull fracture on skull X-ray or CT.	40% for excluding ICI, amongst the 172 who had imaging	100% for detecting ICI	Imaging rate of 35%	3% ICI 11% Skull fractures. Only 1 patient had a neurosurgical intervention.	Yes	Yes	No	No	Yes	98% of patients successfully received a F/U telephone call at 2 weeks	Note only 172 of the 422 patients had a CT or a skull X-ray. The rest were not imaged at all. (41 CT and 96 skull X-rays). Specificity only obtainable for those 172 patients who had imaging. 250 patients excluded from this calculation.

Names and evidence level	Rule description	Participants	Outcomes	Specificity	Sensitivity	CT ordering rate	Prevalence	Derived using primary data	Derived using prospect. data	Validated using primary data	Validated using prospect. data	Multi-variate modelling	Follow-up	Notes
	<p>Derived Rule: Imaging required if score below is 3 or above: (Imaging means skull X-ray for all asymptomatic patients followed by CT for all skull fractures.)</p> <p>0 risk points for any of: Over 12 mths, no scalp haematoma, frontal location.</p> <p>1 risk point for each of: 6-11 mths, small scalp haematoma, occipital location.</p> <p>2 risk points for each of:</p>													<p>Provides a rule for the asymptomatic 0-2 years age category.</p> <p>Non accidental injury patients were included in their study.</p>

National Clinical Guideline Centre, 2014.

Names and evidence level	Rule description	Participants	Outcomes	Specificity	Sensitivity	CT ordering rate	Prevalence	Derived using primary data	Derived using prospect. data	Validated using primary data	Validated using prospect. data	Multi-variate modelling	Follow-up	Notes
	<p>3-5 months, Medium scalp haematoma, Temporal/parietal location.</p> <p>3 risk points for each of: 0-2 months, large scalp haematoma,</p> <p>Range of scores is 0-8 points</p>													
<p>Gruskin et al (1999)¹⁷⁶</p> <p>Level 2 evidence</p> <p>Well conducted</p>	<p>Derived rules:</p> <p>Low risk: Fall<0.9m, no history of neurologic symptoms, normal scalp examination.</p> <p>- May be safely</p>	<p>N=278</p> <p>All GCS scores</p> <p>Children under 2 years old</p> <p>Attendin</p>	<p>Presence of skull fracture or Intracranial</p>	16%	100%	94% if all patients that are not low risk are scanned	4.3% intracranial injury.	Yes	No	No	No	Yes	Protocol not described but states that 4 returned to hospital, one had	This study identifies a small set of patients (43 out of 278) who may be safely discharged.

Names and evidence level	Rule description	Participants	Outcomes	Specificity	Sensitivity	CT ordering rate	Prevalence	Derived using primary data	Derived using prospect. data	Validated using primary data	Validated using prospect. data	Multi-variate modelling	Follow-up	Notes
exploratory cohort study	discharged without investigation	g tertiary paediatric emergency hospital Consecutive patients on hospital database											haemotympanum but normal repeat CT and the other 3 were discharged after re-evaluation	
Hahn et al (1993) ¹⁸⁰ Level 2 evidence	Advise CT in all children with minor head injury, (that is, non trivial, patient has loss of consciousness,	N=791 CCS 13-15 (children's coma	Abnormal CT, Skull fracture on skull X-ray, neurosu	No rule evaluated	No rule evaluated	80%	13% required neurosurgery	Yes	Not clear	No	No	No	Incomplete	This is a prospective observational study followed by guideline construction.

Names and evidence level	Rule description	Participants	Outcomes	Specificity	Sensitivity	CT ordering rate	Prevalence	Derived using primary data	Derived using prospect. data	Validated using primary data	Validated using prospect. data	Multi-variate modelling	Follow-up	Notes
Exploratory cohort study with good reference standards	headache, vomit reduced GCS) and hospital observation. They also recommend follow up CT 12–24 hrs after injury.	score) Children age 0-16 Single level 1 USA children's trauma centre Consecutive patients	urgery death											They did not see if the patients deemed safe for discharge came to harm so the full guideline has not been assessed in this study.
Keskill et al (1995) ²⁵⁰ Level 3 evidence This	Paper concludes that there are no combinations of symptoms or signs that will accurately predict the risk of intracranial injury. They recommend the liberal use of	N=257 GCS 14-15 with full recovery after loss of consciousness	Intracranial complications	No rule evaluated	No rule evaluated	Liberal CT proposed	49 patients (19%) had a mass lesion, 7 patients with an	Yes	No	No	No	Yes	No follow up beyond discharge.	Patients group selected from 1600 patients on review of case histories.

Names and evidence level	Rule description	Participants	Outcomes	Specificity	Sensitivity	CT ordering rate	Prevalence	Derived using primary data	Derived using prospect. data	Validated using primary data	Validated using prospect. data	Multi-variate modelling	Follow-up	Notes
study is not a consecutive cohort of all children with GCS 14-15.	admission and CT	Children under 16 years Single Turkish Hospital Consecutive series of patients admitted to the neurosurgery department. Not consecutive series of all children with					intracranial lesion had no symptoms or signs of head injury and no skull fracture.							

Names and evidence level	Rule description	Participants	Outcomes	Specificity	Sensitivity	CT ordering rate	Prevalence	Derived using primary data	Derived using prospect. data	Validated using primary data	Validated using prospect. data	Multi-variate modelling	Follow-up	Notes
		minor head injury.												
Levi et al (1991) ²⁶⁸ Level 3 evidence This study is not a consecutive study of the population of all patients presenting with head injury.	Paper concludes that age and severity of injury affect outcome and that the presence of a skull fracture is unrelated to the presence of intracranial pathology.	N=653 All GCS scores (41% GCS under 12) Children under 14 years Single Dept neurosurgery Israel. Consecutive cohort	Presence of Skull fracture. Any CT abnormality Disability outcome at 3 months	26% specificity in skull X-ray predicting ICH	68% sensitivity in skull X-ray predicting ICH	No rule given	17.5% craniotomy rate 34.6% abnormal CT rate 43 deaths	Yes	Yes	No	No	No	High follow up rate at 3 months (>98%)	This is a selected group in that only patients who were selected for admission were studied. No data is given on whether any patients not admitted had a negative outcome.

Names and evidence level	Rule description	Participants	Outcomes	Specificity	Sensitivity	CT ordering rate	Prevalence	Derived using primary data	Derived using prospect. data	Validated using primary data	Validated using prospect. data	Multi-variate modelling	Follow-up	Notes
		of patients admitted to the dept of neurosurgery. But non consecutive cohort of all patients presenting with a head injury.												
Lloyd, Carty et al (1997) ²⁷⁹ Level 3 evidence	Recommend skull X-ray only for suspected NAI, depressed fracture or penetrating injury. CT should be Investigation of choice	N=883 All GCS scores who were admitted or had skull	Abnormal CT, Skull fracture on skull X-ray, neurosurgery and	No rule evaluated	No rule evaluated	156 CT scans (possibly 1.7%)	Not clear as results for total population not reported	Yes	Yes	No	No	No	No	They did not test their rule of no skull X-ray and only CT. Rules for CT not explicitly derived

National Clinical Guideline Centre, 2014.

Names and evidence level	Rule description	Participants	Outcomes	Specificity	Sensitivity	CT ordering rate	Prevalence	Derived using primary data	Derived using prospect. data	Validated using primary data	Validated using prospect. data	Multi-variate modelling	Follow-up	Notes
The application of the gold standard of CT scan was dependent on whether the patient had a skull fracture on skull X-ray or was admitted		fracture Children under 16 Single UK paediatric trauma centre Non-consecutive	death											
Loroni et al (1996) ²⁸¹	Validation cohort study with historical control cohort.	Retrospective cohort:	Skull fracture Intracra	84% specificity in validation of rule	100%	33 CT scans in 2nd cohort, 4%	Incidence of intracranial complic	Yes	No	Yes	No	No	'Complicated' patients	Unknown number of minor head injuries followed up.

National Clinical Guideline Centre, 2014.

Names and evidence level	Rule description	Participants	Outcomes	Specificity	Sensitivity	CT ordering rate	Prevalence	Derived using primary data	Derived using prospect. data	Validated using primary data	Validated using prospect. data	Multi-variate modelling	Follow-up	Notes
<p>Level 3 evidence</p> <p>This study is a validation cohort study. This is a level 1 study if you consider absence of return to hospital to be an adequate indicator of uncomplicated</p>	<p>Rule:</p> <p>CT scan and admission if: Coma, depressed consciousness, disorientation, focal neurology.</p> <p>Admission if: Transient loss of consciousness, Amnesia, Vomiting, restlessness, Diffuse headache, suspect basal skull fracture, large scalp haematoma, or depressed fracture, coagulation disorders, previous</p>	<p>N=233</p> <p>All GCS scores</p> <p>Children under 14.</p> <p>Single Italian district general hospital</p> <p>Consecutive</p> <p>Prospective cohort:</p> <p>N=709</p>	<p>nial complications</p>	<p>in 2nd cohort.</p>		<p>ordering rate.</p> <p>No. Of skull X-rays dropped from 81 % to 30 % in asymptomatic patients.</p> <p>Admissions dropped from 16% to 9%</p>	<p>ations 1.27% in 2nd cohort, 1.28% in 1st cohort.</p>						<p>were followed up but this number was not reported.</p> <p>In period A states that no patients re-attended</p> <p>In period B states</p>	<p>No gold standard to exclude intracranial injuries applied except checking that patients had not re-attended to same hospital.</p>

Names and evidence level	Rule description	Participants	Outcomes	Specificity	Sensitivity	CT ordering rate	Prevalence	Derived using primary data	Derived using prospect. data	Validated using primary data	Validated using prospect. data	Multi-variate modelling	Follow-up	Notes
post-discharge progress. However this is inadequate for universal application of a gold standard	craniotomy and shunt. For skull X-ray if: large scalp haematoma, Injury from violent impact with a small object, suspect penetrating injury, suspect base fracture, previous craniotomy with shunt.	All GCS scores Children under 14. Single Italian district general hospital Consecutive											that 4 re-attended but no intracranial complications.	
Mander et al (2000) ²⁹⁰ Level 3 evidence	Exploratory cohort study, retrospective study. No rule is evaluated.	N=166 GCS 13-15 Children under 18 years	Intracranial pathology	No rule evaluated	No rule evaluated	100%	83%	Yes	No	No	No	No	None	The sample is highly selective with little detail about inclusion criteria. High prevalence

Names and evidence level	Rule description	Participants	Outcomes	Specificity	Sensitivity	CT ordering rate	Prevalence	Derived using primary data	Derived using prospect. data	Validated using primary data	Validated using prospect. data	Multi-variate modelling	Follow-up	Notes
Non consecutive exploratory cohort study		old Single Polish neurosurgical unit Non-consecutive as this is a selected population sent to the neurosurgical unit (reflected in the prevalence of ICH)												rate makes it very difficult to interpret.

Names and evidence level	Rule description	Participants	Outcomes	Specificity	Sensitivity	CT ordering rate	Prevalence	Derived using primary data	Derived using prospect. data	Validated using primary data	Validated using prospect. data	Multi-variate modelling	Follow-up	Notes
Murgio (2001) ³³³ Level 3 Evidence Non-consecutive study	Multicentre Exploratory cohort study. Concludes that skull X-ray is unwarranted but no rule for the management of head injuries in children is proposed	N=4690 GCS 13-15 Children 0-15 years Patients attending hospitals in Argentina, Brazil, France, Hong Kong, and Spain. Non-consecutive	Abnormality on CT scan Neurosurgical Intervention Glasgow outcome score on follow up	No rule proposed	No rule proposed	14% CT rate in study	7 deaths 81 had neurosurgical intervention 5.6% pathological CT scan rate	Yes	Yes	No	No	No	Follow up at 2-weeks and 2-months. 79% face to face, and 21% by telephone	Large study but cohort is highly selected from multiple hospitals in multiple countries some of whom provided very small numbers, so not clear whether this is truly representative of the full minor head injury population attending emergency departments.

Names and evidence level	Rule description	Participants	Outcomes	Specificity	Sensitivity	CT ordering rate	Prevalence	Derived using primary data	Derived using prospect. data	Validated using primary data	Validated using prospect. data	Multi-variate modelling	Follow-up	Notes
<p>Quayle et al (1997)⁴⁰⁸</p> <p>Level 3 evidence</p> <p>Consecutive Exploratory cohort study but see notes for details of study weaknesses</p>	<p>Study found association with skull fracture, loss of consciousness for 5 mins, altered mental status, and focal neurology. But absence of any of these factors does not exclude ICH</p>	<p>N=322</p> <p>All GCS scores</p> <p>Children under 18,</p> <p>Single USA paediatric trauma hospital</p> <p>Consecutive patients</p>	<p>Positive CT scan</p>	<p>No rule evaluated</p>	<p>No rule evaluated</p>	<p>98%</p>	<p>8% = ICH</p>	<p>Yes</p>	<p>Yes</p>	<p>No</p>	<p>No</p>	<p>Yes</p>	<p>Yes by telephone 3-7 days later.</p>	<p>Prospective study comparing usefulness of skull x-ray and other clinical features in identifying intracranial injury. CT used as gold standard. 314 children aged from 0 to 18 years. Huge difference between 321 in sample and 89 not entered in terms of admission rates (3% vs. 26%), suggesting</p>

Names and evidence level	Rule description	Participants	Outcomes	Specificity	Sensitivity	CT ordering rate	Prevalence	Derived using primary data	Derived using prospect. data	Validated using primary data	Validated using prospect. data	Multi-variate modelling	Follow-up	Notes
														that the less clinically serious 'non-trivial' head injuries are being ignored. This could affect the estimates of negative predictive value and positive predictive value by increasing the number of false positives (sign or symptom present but no intracranial injury) or by increasing

Names and evidence level	Rule description	Participants	Outcomes	Specificity	Sensitivity	CT ordering rate	Prevalence	Derived using primary data	Derived using prospect. data	Validated using primary data	Validated using prospect. data	Multi-variate modelling	Follow-up	Notes
														<p>the number of true negatives (sign or symptom not present and no intracranial injury).</p> <p>The raw data is not in the paper, but if they say that there were 27 IC injuries out of 314 (321 less 7 without CT), and that 13 of these had no skull fracture, then only 14 of the 50 skull fractures</p>

Names and evidence level	Rule description	Participants	Outcomes	Specificity	Sensitivity	CT ordering rate	Prevalence	Derived using primary data	Derived using prospect. data	Validated using primary data	Validated using prospect. data	Multi-variate modelling	Follow-up	Notes
														<p>were associated with IC injury. This gives a univariate odds ratio of 7.51 (not 21.5). Although this is still significant, it makes me wonder about the veracity of all the other results, as this is the most significant result. Emphasis on odds ratios glosses over the fact that the positive</p>

Names and evidence level	Rule description	Participants	Outcomes	Specificity	Sensitivity	CT ordering rate	Prevalence	Derived using primary data	Derived using prospect. data	Validated using primary data	Validated using prospect. data	Multi-variate modelling	Follow-up	Notes
														and negative predictive values are arguably more important.
Roddy et al (1998) ⁴²¹ Level 2 evidence Exploratory cohort study in minor head injury after normal CT scan	Rule: Patients following minimal head trauma with normal CNS exam and normal CT scan may be safely discharged	N=62 GCS 15 only Children under 16 Single US level 1 trauma centre consecutive	Delayed ICH	No positive outcomes	No positive outcomes in the study	100%	0%	Yes	no	no	no	no	All patients were followed up until discharge. No further follow up thereafter.	From 277 children admitted in the study period, 62 met the strict entry criteria. Low power study that tries to exclude late deterioration
Schunk	Study does not	N=313	Intracra	No rule	No rule	100%	28%=ICI	Yes	No	No	No	No	None	Small series

Names and evidence level	Rule description	Participants	Outcomes	Specificity	Sensitivity	CT ordering rate	Prevalence	Derived using primary data	Derived using prospect. data	Validated using primary data	Validated using prospect. data	Multi-variate modelling	Follow-up	Notes
et al (1996) ⁴⁴⁸ Level 3 evidence Non consecutive exploratory cohort study	evaluate a rule – looks at CT-scan patients only. 100% was not the rule. Retrospective review.	GCS 15 and no focal neurology Children under 18 years old. Single USA paediatric level 1 trauma centre Non-consecutive. Only patients who had	nial injury Need for neurosurgery	evaluate d	evaluat ed									of CT-scans.

Names and evidence level	Rule description	Participants	Outcomes	Specificity	Sensitivity	CT ordering rate	Prevalence	Derived using primary data	Derived using prospect. data	Validated using primary data	Validated using prospect. data	Multi-variate modelling	Follow-up	Notes
		CT included , no criteria for CT ordering was in place.												
Shane et al (1997) ⁴⁶² Level 3 evidence Small retrospective exploratory cohort study, which is not consec	Conclusion is that the presence of any symptoms or signs as well as a skull fracture is 100% sensitive but not specific for ICH	N= 102 Awake infants only GCS not used Infants under 13 months of age Single USA children's	ICI	35 % specificity for excluding ICI in children with a fracture but no symptoms or signs (Only calculated for the 32 children	100% sensitivity for finding ICI amongst those with skull fracture and symptoms or signs	If the rule is any child with symptoms or signs should have CT scan the ordering rate would	15% had ICI 2% neurosurgery	Yes	No	No	No	No	Retrospectively from neurosurgical review clinics	Half of the children were tertiary referrals. Very small numbers in this retrospective study and this rule is not validated. Only applicable to a very small subset of patients under 13

Names and evidence level	Rule description	Participants	Outcomes	Specificity	Sensitivity	CT ordering rate	Prevalence	Derived using primary data	Derived using prospect. data	Validated using primary data	Validated using prospect. data	Multi-variate modelling	Follow-up	Notes
tive for all <13mth children with head injury (only those with skull fracture included)		paediatric trauma centre Non Consecutive as only patients with a skull fracture studied		who had CT scan)		be 76% as 76 patients in the whole study had symptoms /signs.								mths of age with a Skull fracture.
Simon et al (2001) ⁴⁶⁹ Level 3 evidence Non consecutive	Exploratory cohort study designed to establish the incidence and identify risk factors for intracranial injury in children aged under 16 years.	N=429 GCS 14-15 with No suspicious neurological symptoms, but	Intracranial injury	No rule evaluated	No rule evaluated	100%	14%	Yes	No	No	No	Yes	None	Authors conclude that a normal neurologic exam and maintained consciousness does not rule out ICI in children who have had a high-risk

Names and evidence level	Rule description	Participants	Outcomes	Specificity	Sensitivity	CT ordering rate	Prevalence	Derived using primary data	Derived using prospect. data	Validated using primary data	Validated using prospect. data	Multi-variate modelling	Follow-up	Notes
retrospective exploratory cohort study	Retrospective review, not consecutive patients.	<p>high risk mechanism</p> <p>Children under 16 years.</p> <p>Single USA paediatric level 1 trauma centre</p> <p>Non-consecutive, 569 eligible patients but only 429 had reliable records</p>												mechanism of injury. The sample is highly selective, with no follow-up and retrospective data collection.

Names and evidence level	Rule description	Participants	Outcomes	Specificity	Sensitivity	CT ordering rate	Prevalence	Derived using primary data	Derived using prospect. data	Validated using primary data	Validated using prospect. data	Multi-variate modelling	Follow-up	Notes
Toupin et al (1995) ⁵¹⁸ Level 3 evidence	Audit of practice – describes reduction in x-ray rate and states that no complications were missed. Looks at children only.													
Wang et al (2000) ⁵³¹ Level 3 evidence Highly selective prospective exploratory cohort study	Recommend CT scan for all GCS 13 and 14 patients	N=209 GCS 13-14 Children age under 15 Attending 13 trauma centres serving Los Angeles USA	Abnormal CT, neurosurgery	No rule evaluated	No rule evaluated	Overall population results not reported. This cohort had 86% CT rate	Overall population results not reported. 27.4% abnormal CT rate	Yes	Yes	No	No	No	No	This study is GCS 13, 14 only.

Names and evidence level	Rule description	Participants	Outcomes	Specificity	Sensitivity	CT ordering rate	Prevalence	Derived using primary data	Derived using prospect. data	Validated using primary data	Validated using prospect. data	Multi-variate modelling	Follow-up	Notes
		Non Consecutive in the sense that this cohort was selected from a cohort of 8488 patients.												

O.7.7 Clinical prediction rules for selecting adults with head injury for imaging

O.7.7.1 Update studies 2007

Table 95: Mower2005

Study details	Patients	Interventions	Outcome measures	Effect size	Comments
Mower2005 ³²⁷	Patient group: All blunt trauma patients that underwent head CT in 21 participating centres. All patients N: 13728 age (median): 37 yrs M/F: 8988/4718	Development of NEXUS II prediction rule for CT imaging of patients with head injury Intervention under investigation: NEXUS II Reference standard: CT	Recursive partitioning identified eight criteria that were independently and highly associated with intracranial injuries: 8 criteria form decision model Derivation of NEXUS prediction rules: clinically important ICI Sensitivity Specificity NPV Prevalence ICI identified Patients presenting with minor head injuries; identification of clinically important ICI: Sensitivity Specificity	Evidence of significant skull fracture scalp hematoma neurologic deficit altered level of alertness abnormal behaviour coagulopathy persistent vomiting age 65 years or more 98.3% (95% CI,97.2-99.0) 13.7% (95% CI,13.1-14.3) 99.1% (95% CI,98.5-99.5) 917/12728 (6.7%) 901/917 95.2% (95% CI,92.2-97.2) 17.3% (95% CI,16.5-18.0)	Funding: Grant from Agency for Healthcare research and quality Limitations: Derivation study (not validated). Patients with blunt head trauma that did not receive CT scan were excluded from study. Additional outcomes: NR 2397 patients had sustained blunt head trauma but were not included in study as did not have CT scanning. Assessed potential of verification bias by follow up of 1,266 of these patients that agreed: CT scanning was ultimately performed in 27 patients (2.1%), MRI in 29 (2.3%) and skull radiography n 14 (1.1%). No significant injuries were found in any of these excluded patients. Notes:

National Clinical Guideline Centre, 2014.

Study details	Patients	Interventions	Outcome measures	Effect size	Comments
			NPV Prevalence ICI identified	99.1% (95% CI,98.5-99.5) 330 314/330	Includes patients that had not experienced loss of consciousness unlike other prediction rules (CCHR).

Table 96: Smits 2005

Study details	Patients	Interventions	Outcome measures	Effect size	Comments
Smits 2005 ⁴⁷² Study design: External Validation Prospective Cohort Study (diagnostic test) Evidence level: diagnostic study level-2+	Patient group: Consecutive patients in 4 Dutch university hospitals. Inclusion criteria: 1) presented within 24 hours after blunt head injury 2) older than 16years 3) GCS score of 13 to 14 4) GCS score of 15 with 1 of following risk factors: history of loss of	Intervention under investigation: NOC and CCHR decision rules Reference standard: All patients received CT scan Neurosurgical intervention: n=17 (0.5%) Neurocranial traumatic CT findings: n=312 (9.8%)	Original NOC (n=1307) Neurosurgical Intervention: Sensitivity Specificity Neurocranial traumatic CT findings: Sensitivity Specificity Important CT Finding: Sensitivity Specificity Adapted NOC (n=3181) Neurosurgical intervention Sensitivity Specificity Neurocranial traumatic CT findings: Sensitivity Specificity	% (95% CI) 100.0 (34.2-100.0) 5.3 (2.5-8.3) 98.3 (94.0-99.5) 5.6 (2.7-8.8) 97.7 (92.1-99.4) 5.5 (2.6-8.7) % (95% CI) 100.0 (81.6-100) 3.0 (1.2-4.8) 99.4 (97.7-99.8) 3.2 (1.4-5.2)	Funding: Grant from college voor Zorgverzekeringen Limitations: Adaptations to rules as described below in notes. Additional outcomes: CT reduction was also reported. GCS evaluated at 1 hour after presentation instead of after 2 hours (Steill study found GCS of less than 15 at 2 hours was a risk factor). Notes: The decision rules were designed for specific patient populations, which were more restricted than investigators patient population. They performed validation analyses in subgroup of patients for whom the decision rule as designed (original

Study details	Patients	Interventions	Outcome measures	Effect size	Comments
Duration of follow-up: 30 days	consciousness, short-term memory deficit, amnesia for traumatic event, posttraumatic seizure, vomiting, severe headache, clinical evidence of intoxication, use of anticoagulants, physical evidence of injury above clavicles and neurological deficit. All patients N: 3181 Age (mean): 41.4 (16.0-102.3) M/F: 2244 / 937		Important CT findings		decision rules). They then adjusted the original decision rules for use in entire study population, which also included patients without a history of loss of consciousness, by adding the exclusion criteria of original rules as additional risk factors, referred to as the adapted decision rules. Therefore, adapted NOC included risk factors neurological deficit and a GCS score of 13 or 14, and adapted CCHR include risk factors anticoagulation, posttraumatic seizure, and neurological deficit in addition.
			Sensitivity	99.2 (97.1-99.8)	
			Specificity	3.1 (1.3-5.1)	
			Original CCHR (n=1307)	% (95% CI)	
			Neurosurgical intervention		
			Sensitivity	100.0(64.6-100)	
			Specificity	37.2 (34.1-40.4)	
			Neurocranial traumatic CT findings:		
			Sensitivity	83.4 (77.7-87.9)	
			Specificity	39.4 (36.0-42.8)	
			Important CT findings		
			Sensitivity	84.5 (78.1-89.3)	
Specificity	38.9 (35.6-42.3)				
Adapted CCHR (n=3181)	% (95% CI)				
Neurosurgical intervention					
Sensitivity	100.0 (81.6-100.0)				
Specificity	37.5 (34.9-40.0)				
Neurocranial traumatic CT findings:					
Sensitivity	85.0 (80.5-88.5)				
Specificity	39.7 (37.0-42.4)				
Important CT findings					
Sensitivity	87.2 (82.5-90.9)				
Specificity	39.3 (36.6-42.0)				

Table 97: Stiell 2005

Study details	Patients	Interventions	Outcome measures	Effect size	Comments
<p>STIELL 2005⁴⁹³</p> <p>Study design: Prospective Diagnostic Cohort Study</p> <p>Evidence level: Diagnostic study level-1+</p> <p>Duration of follow-up: 14 day follow up by telephone for</p>	<p>Patient group: Consecutive adult patients who had sustained acute minor head injury in 9 Canadian tertiary care teaching hospital emergency departments.</p> <p>Inclusion depended on the patients having all of the following</p> <p>(1) blunt trauma to the head resulting in witnessed loss of consciousness, definite amnesia or witnessed disorientation,</p> <p>(2) initial emergency department GCS score of 13 or greater as determined by treating physician and</p> <p>(3) injury within the previous 24 hours.</p> <p>Patients: GCS score of</p>	<p>Intervention: The Canadian CT Head Rule (CCHR) and the New Orleans Criteria (NOC) were assessed on patients who presented with a GCS score of 15. In addition the Canadian rule was assessed for all patients in the study (those presenting with scores of 13-15).</p> <p>Diagnostic test: NOC and CCHR prediction rule tests</p>	<p>Need for neurosurgical intervention</p> <p>Sensitivity</p> <p>Specificity</p> <p>NPV</p> <p>Prevalence</p>	<p>CCHR (n=1822)</p> <p>100% (95% CI 63% to 100%)</p> <p>76.3% (95% CI 74% to 78%)</p> <p>99.5%</p> <p>8 (0.4%)</p>	<p>Funding: Peer reviewed grants from Canadian Institutes of Health Research and Ontario Ministry of Health Emergency Health Services Committee.</p> <p>Additional outcomes:</p> <p>Interobserver agreement for each variable and for interpretation of the two rules was measured with the weighted k coefficient. Weighted k value for physician interpretation of the overall rules in 49 cases was 0.85 (95% CI 0.58-0.92) for CCHR and 0.47 (95% CI -0.13-1.0) for the NOC. Physician's theoretical comfort and perceived ease of use of the rules was reported. Length of time spent in the hospital was calculated for patients that did and did not undergo a CT scan.</p> <p>Notes:</p> <p>CT scans were interpreted by qualified staff neuroradiologists who were blinded to the information on the data collection sheet.</p> <p>Potential impact on CT ordering evaluated by estimating the proportion of patients who would require CT imaging according to the</p>
			<p>Need for neurosurgical intervention</p> <p>Sensitivity</p> <p>Specificity</p> <p>NPV</p> <p>Prevalence</p>	<p>NOC (n=1822)</p> <p>100% (95% CI 63% to 100%)</p> <p>12.1% (95% CI 11% to 14%)</p> <p>97.1%</p> <p>8 (0.4%)</p>	
			<p>Clinically important brain injury</p> <p>Sensitivity</p> <p>Specificity</p> <p>NPV</p> <p>Prevalence</p>	<p>CCHR (n=1822)</p> <p>100% (95% CI 96 to 100)</p> <p>50.6% (95% CI 48-53)</p> <p>90.9%</p> <p>97 (5.3%)</p>	
			<p>Clinically important brain injury</p> <p>Sensitivity</p> <p>Specificity</p> <p>NPV</p> <p>Prevalence</p>	<p>NOC (n=1822)</p> <p>100% (95% CI 96% to 100%)</p> <p>12.7% (95% CI 11-14)</p> <p>71.6%</p> <p>97 (5.3%)</p>	

Study details	Patients	Interventions	Outcome measures	Effect size	Comments
patients that did not receive CT imaging.	15 N:1822 Age (mean): 37.7 (SD 18) M/F: 1246/576	Reference standard: CT scan	Need for neurosurgical intervention (using high risk criteria)	CCHR (n=2707)	rules. For entire cohort the CT imaging rate according to CCHR would have been 62.4% (95% CI, 61-64); the actual CT rated for these cases was 80.2% at the 9 study sites. Sensitivity and specificity of patients calculated for all brain injury including the unimportant brain injury. CCHR: Sensitivity 93.1% and 51.4% specificity. NOC: sensitivity was 98.6% and specificity 12.9%.
	Sensitivity		100% (95% CI 91% to 100%)		
	Specificity		65.6% (95% CI 64% to 67%)		
	All patients: GCS: 13-15 N: 2707 Age (mean): 38.4 (SD 18) M/F: 1884/823		Clinically important brain injury (using high and medium risk criteria)	CCHR (n=2707)	
			Sensitivity	100% (95% CI 98 to 100)	
			Specificity	41.1% (95% CI 39 to 43)	
			Prevalence	231 (8.5%)	
			CT Ordering Rates for patients with GCS of 15 (n=1822)	CCHR=52.1% (95% CI 50-54) NOC= 88.0% (95% CI 86-89) P<0.001	

Table 98: Dunning 2006

Update studies 2007

Study details	Patients	Diagnostic tools	Outcomes	Results	Comments
<p>Dunning2006¹¹⁷</p> <p>Study design: Prospective diagnostic cohort study</p> <p>Evidence level: Diagnostic study level-2+</p> <p>Duration of follow-up: Study over 2.5 years and follow-up by multi-modal</p>	<p>Patient group: All children (under 16 years) with any severity of head injury presenting at ten ED hospitals in Northwest of England.</p> <p>Head Injury defined as: - a history of a blow to the head, with or without a period of unconsciousness or amnesia; - external evidence of injury to the head - simple laceration to the face and neck without a history of a blow to the head is not considered to be a HI.</p> <p>All patients N: 22,772 Age < 5 yrs: 56%</p>	<p>Assessment tool under investigation: CHALICE prediction rule for children.</p> <p>Recursive partitioning to construct clinical guidelines from 40 clinical variables that were significantly associated to intracranial pathology.</p> <p>Reference standard: CT and clinical follow-up</p>	<p>CHALICE prediction rule</p>	<p>A CT scan is required if any of the following criteria are present:</p> <p>HISTORY</p> <ul style="list-style-type: none"> - Witnessed loss of consciousness (LOC) of over 5 minutes in duration - History of amnesia of over 5 minutes in duration - Presence of abnormal drowsiness - Three or more vomits after head injury - Suspicion of Non-Accidental Injury - Seizure after head injury in a non-epileptic patient <p>EXAMINATION</p> <ul style="list-style-type: none"> - GCS <14, or GCS <15 if under 1yr old - suspicion of penetrating or depressed skull injury or tense fontanelle - signs of a basal skull fracture - positive focal neurology - presence of bruise/swelling or laceration over 5cms in a child under 1 year <p>MECHANISM</p> <ul style="list-style-type: none"> - high speed road traffic accident either as pedestrian, cyclist or occupant (defined as 	<p>Funding: RCS for Enid Linder Foundation research Fellowship, Child Brain Injury Trust, Dickinson Trust.</p> <p>Limitations: Rule not yet validated.</p> <p>Other outcomes: SR and meta-analysis of existing studies to determine significant predictors of intracranial haemorrhage. These risk factors were used in a pilot study to create a clinical record form.</p> <p>Interobserver variability of clinical variables collected in the study was assessed. Good correlation found hours since injury, LOC,</p>

Study details	Patients	Diagnostic tools	Outcomes	Results	Comments
method of patient monitoring across northwest of England.	M/F: 65%/35% Prevalence: Positive CT: 281 (1.2%) Neurosurgical op: 137 (0.6%) Died: 15 (0.1%)			accident over 40mph) - fall of over 3m in height - high speed injury from a projectile or object If none of above correlates are present, the patients are at low risk of intracranial pathology.	amnesia, vomiting and laceration. Relatively poor for speed of agent, agent category, headache, number of injuries, bruising and swelling.
			Significant intracranial pathology:	CHALICE	
			Sensitivity Specificity NPV Prevalence CT scan rate Missed cases	98.6% (95% CI, 96.4-99.6) 86.9% (95% CI, 86.5-87.4) 100.0% 281 (1.2%) 14% (95% CI, 13.6-14.6) 4	
			Significant intracranial pathology:	NICE guidance (CCHR)	
			Sensitivity Specificity Prevalence CT scan rate Missed cases	94% (95% CI, 91-97) 89% (95% CI, 89-90) 281 (1.2%) 12% 16	

Table 99: Haydel 2003

Study details	Patients	Diagnostic tools	Measure of Disorders	Results	Comments
<p>Haydel2003¹⁹ 5</p> <p>Study design: Prospective diagnostic study</p> <p>Evidence level: Diagnostic study level-1+</p> <p>Duration of follow-up: study over 30 month period but not followed up after left hospital.</p>	<p>Patient group: consecutive 5-17 year old patients presenting at a large inner-city Level I trauma centre presenting with minor head injury (defined as blunt head trauma with loss of consciousness with a normal GCS score, or modified coma scale for infants and children and normal brief neurologic examination). Patients included if presenting within 24 hours of injury. Only included patients with nontrivial mechanisms of injury.</p> <p>All patients N: 175 Age (mean): 12.8 years M/F(%): 67:33</p>	<p>Assessment tool under investigation: NOC on children</p> <p>Reference standard: CT scan</p>	<p>Intercranial injury or depressed skull fracture</p> <p>Sensitivity Specificity Prevalence</p> <p>Reduction in ordering rates</p> <p>Intervention for patients with intercranial injuries</p>	<p>100% (95% CI 73% to 100%) 25.5% (95% CI 19.1% to 33%) 14 (8%; 95% CI 4.6% to 13.3%)</p> <p>23.4% (95% CI 17.7 to 30.2%)</p> <p>(n=14) Operative: 1 (7.1%) Medical: 5 (36%) Observed: 8 (57%)</p>	<p>Funding: Authors report this study did not receive any outside funding or support.</p> <p>Additional Outcomes: Intracranial injury reported in sub age groups of 5-10 yrs and 11-17 yrs.</p> <p>Limitations: Pilot study so sample size small and underpowered to produce narrow confidence intervals.</p> <p>Notes: There were two isolated skull fractures in addition to 14 intercranial injuries.</p> <p>The set of 6 criteria was significantly associated with an abnormal CT scan result on x2 analysis (p<0.05).</p>

Table 100: Oman 2006

Study details	Patients	Interventions	Outcome measures	Effect size	Comments
Oman 2006 ³⁶⁴	Patient group: Children presenting with blunt head trauma (under 18 years) that underwent CT scanning from NEXUS II cohort of 21 emergency departments. All patients N: 1666 Age (median): 11.3 (4.4-15.9) years M/F: 1072/594	Intervention under investigation: NEXUS II on children NEXUS rules: 8 criteria: evidence of significant skull fracture, altered level of alertness, neurologic deficit, persistent vomiting, presence of scalp hematoma, abnormal behaviour, coagulopathy and age over 65 years (age criteria excluded as all under 18yrs) Reference standard: CT scan	Clinically important ICI	All subjects (n=1666)	Funding: Grant from the Agency for Healthcare Research and Quality. Limitations: Derivation study – not validated. Additional outcomes: NR
Study design: Diagnostic-Prospective Cohort			Sensitivity Specificity NPV Prevalence	98.6% (95% CI, 94.9-99.8) 15.1% (95% CI, 13.3-16.9) 99.1% (95% CI, 96.9-99.9) 138 (8.3%)	
Evidence level: diagnostic study level-2+			Clinically important ICI	Children under 3yrs (n=309)	Notes: Clinically important intracranial injury (ICI) defined as patient that requires neurosurgical intervention. ICI's were missed in two children. Authors suggest that the specificity could be underestimated due to the fact that the study only enrolled children that had been selected for CT scanning.
Duration of follow-up: NR			Sensitivity Specificity NPV Prevalence	100% (95% CI, 86.3-100) 5.3% (95% CI, 3.0-8.6) 100% (95% CI, 78.2-100) 25 (8.1%)	

Table 101: Palchak 2003

Study details	Patients	Diagnostic tools	Outcomes	Results	Comments
Palchak 2003 ³⁷⁵	Patient group: children (<18 years) with blunt head trauma at a paediatric ED of level 1 trauma centre from July 1998 to September 2001.	Assessment tool under investigation: Patient examined by faculty emergency physicians and clinical findings recorded on standardised data sheet before CT scan (if CT obtained). CT scans ordered at discretion of treating faculty physicians.	Traumatic brain injury (presence of intracranial haemorrhage, haematoma or cerebral edema)	Presence of any of the predictors - Abnormal mental status - Clinical signs of skull fracture - History of vomiting - Scalp hematoma in children aged 2 yrs or younger. - headache	Funding: supported by a Hibbard E. Williams Grant, University of California-Davis School of Medicine; Faculty Research Grant, University of California-Davis School of Medicine; and A Children's Miracle Network Grant.
Study design: prospective cohort study	Included: Presenting after a history of nontrivial blunt head trauma with historical or physical examination findings consistent with head trauma. These findings included a history of loss of consciousness, amnesia, seizure, vomiting, current head ache, dizziness, nausea, or vision change or physical examination findings of abnormal mental status, focal neurologic deficits, clinical signs of skull fracture, or scalp trauma. This included children with head injuries of all severities.	Recursive partitioning to construct clinical decision rules.	Traumatic brain injury identified on CT		Limitations: 77.4% of eligible children enrolled. Study not yet validated.
Evidence level: Diagnostic study level-2+	Excluded: trivial head trauma defined by falls from ground level or trauma resulting from walking or running into stationary objects if the only abnormal finding was a scalp laceration or abrasion. Also children transferred to the site if CT scan previously performed before transfer.	Reference standard: CT and clinical follow up. Medical records of hospitalised patients were	Sensitivity Specificity NPV PPV Prevalence CT scan rate Missed cases	99% (95% CI 94.4% to 100%) 25.8% (95% CI 23.3% to 28.4%) 99.7% (95% CI 98.2% to 100%) 10.0% (95% CI 8.2% to 12.1%) 98/1271(7.7%) 1271/2043 1 of 98	Other outcomes: Decision rules for TBI identified on CT and TBI requiring intervention were formed. The resulting decision rule is a combination of the two.
Duration of follow-up: NR			Traumatic brain injury requiring intervention		Sub-analysis performed on children with GCS 14 or 15 and another on children 2 years and under. Also sub-analysis on patients that required a neurosurgical procedure as
			Sensitivity Specificity NPV PPV	100% (95% CI 97.2% to 100%) 42.7% (95% CI 40.5% to 44.9%) 100% (95% CI 99.6% to 100%) 8.6% (95% CI 7.1% to 10.4%)	

Study details	Patients	Diagnostic tools	Outcomes	Results	Comments
	All patients N: 2043 Age: mean 8.3 years (10days to 17.9 years) N<2 yrs: 327 (16%) M/F: 65%/35% Median GCS: 15 N that had CT: 1271 (62.2%)	reviewed. All patients discharged to home received a follow up telephone call approx 1 week after. At study completion, reviewed morgue records and hospital trauma centre registry	Prevalence CT scan rate Missed cases	105/2043 1271/2043 0 of 105	outcome. Two faculty emergency physicians independently evaluated a convenience sample of 5% of patients to assess inter-observer agreement. Notes: Isolated skull fractures not considered traumatic brain injuries.

Table 102: Brohi 2005

Update studies 2007

Study details	Patients	Diagnostic Tool	Outcome measures	Effect size	Comments
Brohi 2005 ⁶² Study design: Prospective Diagnostic Cohort Study Evidence	Patient group: Consecutive unconscious intubated blunt trauma patients underwent hospitals new protocol for spinal evaluation. Protocol: -Lateral cervical spine plain film,	Assessment tools under investigation: Helical CT scan (single slice) and single cross table lateral film. Consultant trauma radiologist reported images.	Helical CT scan : Cervical spine injuries: Sensitivity Specificity Negative predictive value Prevalence Unstable C-spine injuries: Sensitivity Specificity	n=381 98.1% 98.8% 99.7% 61 (14%) 100.0% 99.0%	Funding: NR Limitations: CI not reported. Additional outcomes: Does not discuss blinding of results of different imaging results. Notes:

Study details	Patients	Diagnostic Tool	Outcome measures	Effect size	Comments
level: Diagnostic study level-2+ Duration of follow-up: Patients followed through their hospital stay.	-Risk of thoracic and lumbar spine injury had anteroposterior and lateral views, -CT scan, -MRI if previous results show suspicion of ligamentous injury or abnormal neurology prior to intubation. All patients N: 442 Age (median): 34 IQR: 25-50 M:F ratio: 2.6:1 Drop outs: 63 died before completion – but 2 had received MRI scan and could be included in HCT outcomes.	Reference standard: Clinical outcome and/or MRI. Follow up of patients once they regained consciousness and followed through their hospital stay to account for any missed spinal injuries.	Negative predictive value	100.0%	381 patients had CT scan that was followed up by MRI or patient follow-up.
			Prevalence	31 (7.0%)	
			Cross-table Lateral Film	n=421	421 patients had cross table lateral film. 21 patients went straight to CT without a lateral radiograph for reasons of clinical priority.
			Sensitivity	72.1	
			Specificity	94.2	
			Negative predictive value	95.2	
Prevalence	59 (14%)	CT identified 60/61 c-spine injuries. One false negative was an undisplaced fractured of the anterior inferior body of C3, which was visible on cross-table lateral film. MRI confirmed injury was stable with no ligamentous disruption.			
Adequate lateral films	n=200				
Sensitivity	53.3%				
Specificity	91.7%	Lateral film identified 24 of 59 with spine injuries and 15 of the 29 with unstable fractures.			
NPV	87.0%				
Prevalence	29 (7%)				
Adequate, Unstable lateral films					
Sensitivity	75.0%				
Specificity	91.7%				
NPV	95.1%				

Table 103: Holmes 2005

Study details	Patients	Diagnostic Tool	Outcome measures	Effect size	Comments
<p>Holmes 2005²¹⁸</p> <p>Study design:</p> <p>Meta-analysis</p> <p>Evidence level: Diagnostic study level-2+</p> <p>Duration of follow-up: NR</p>	<p>Patient group: 7 different studies included^{21,41,106,173,359,443,533}, of which 5 were level 3 and 2 studies were level 4.</p> <p>Studies: Level 1 studies included RCT comparing CT with plain radiography</p> <p>Level II studies included those studies with a sample size >50 subjects, a representative sample of subjects and employment of an independent gold standard test.</p> <p>Level III studies consisted of a sample size > 50 subjects, minimal to moderate selection bias, or lacing in an independent gold standard.</p> <p>Level 4 studies consisted either <50 subjects or a severe selection bias</p> <p>All patients N: 3834 Age (mean): NR M/F: NR</p>	<p>Medline search: studies included either RCT or cohort study consisting of patients undergoing plain radiography and helical CT of c-spine for the detection of blunt c-spine injury.</p> <p>Assessment tool under investigation: Plain radiography and CT scan</p> <p>Reference standard: All studies failed to include an independent gold standard. Used either CT scan, or interpretation of</p>	<p>Pooled results of Plain Radiography</p> <p>Patients with C-spine injury:</p> <p>Sensitivity</p> <p>Heterogeneity for sensitivity</p> <p>Specificity</p> <p>Pooled results of CT</p> <p>Patients with C-spine injury:</p> <p>Sensitivity</p> <p>Heterogeneity for sensitivity</p> <p>Specificity</p>	<p>52% (95% CI 47-56%)</p> <p>0.07</p> <p>NR</p> <p>98% (95% CI 96-99%)</p> <p>0.99</p> <p>NR</p>	<p>Funding: NR</p> <p>Limitations: Specificity of these two tests could not be calculated due to limitations of the data. The authors reported that none of the studies included an independent gold standard test, instead patients with an abnormality identified on c-spine CT scan were considered to have an injury present.</p> <p>Additional outcomes: Due to heterogeneity identified in the sensitivity of plain radiography they performed sensitivity analysis by eliminating the two level 4 studies. Pooled sensitivity for c-spine plain radiography was 54% (95% CI 48-59%) and for CT was 98% (95% CI 95-99%).</p> <p>Notes: 2 reviewers worked on this meta-</p>

Study details	Patients	Diagnostic Tool	Outcome measures	Effect size	Comments
	Majority of patients > 16 years in the studies.	all films and clinical records.			analysis and extracted data.

Table 104: Nguyen 2005

Study details	Patients	Diagnostic Tool	Outcome measures	Effect size	Comments
<p>Nguyen 2005³⁵²</p> <p>Study design: Prospective Cohort Study</p> <p>Evidence level: Diagnostic study level-2+</p> <p>Duration of follow-up: NR</p>	<p>Patient group: All patients with blunt trauma who underwent imaging over 70 days from a level 1 trauma centre hospital.</p> <p>All patients N: 219 Age (mean): Range 2-96 M/F: 128/91</p> <p>High risk patients: N: 34 Age: 11-88 yrs M/F: 22/12</p> <p>Patients with plain</p>	<p>Intervention: All major trauma patients were automatically screened with standard three-view cervical spine radiography and CT. Very low risk patients only had a CT scan as ordered by treating physicians at their own discretion.</p> <p>Patients retrospectively divided into three categories: very low risk (n=107), low risk (n=78) and high risk (n=34).</p> <p>Assessment tool under investigation: Plain radiographs (3-view)</p> <p>Reference standard: CT</p>	<p>High risk group (n=34) Outcome: fracture Plain radiography</p> <p>Sensitivity Specificity Prevalence Identified</p>	<p>93.3% 95.0% 15 (6.8%) 14/15</p>	<p>Funding: NR Limitations:</p> <p>Additional outcomes: The very low risk group only had CT scans and no fractures were found. The low risk group had no fractures seen by CT and plain radiographs.</p> <p>The high risk group had 15 fractures in the group of 34 patients. X-ray missed one of these fractures. It was a nondisplaced fracture through the C7 left facet. This injury had no soft tissue abnormality and no misalignment.</p> <p>Notes: CT and Radiographs performed on low risk and high risk categories only (n=112).</p> <p>High risk patients: major trauma</p>

National Clinical Guideline Centre, 2014.

Study details	Patients	Diagnostic Tool	Outcome measures	Effect size	Comments
	radiography and CT: 112				patients, high clinical suspicion, abnormal neurological exam, intoxication or unresponsiveness or inadequate x-rays

O.7.8 Diagnostic tools on cervical spine imaging -Economics evidence

Study details	Patients	Interventions	Outcome measures	Effect size	Comments
Adelgais 2004 ⁴ USA	Patient group: patients aged 0-14 presenting at a level 1 paediatric trauma centre who required cervical spine radiographic evaluation in addition to cranial CT All patients N: 136 Group 1 N: 64 (36 received group 2's protocol) Mean age: 6.9 M/F 38/26 Drop outs: 0 Group 2	Group 1: Conventional Radiography (ConvRad) Group 2: HCT	Mean emergency department length of stay (minutes)	Group 1: 183 Group 2: 259 p value: NR	Funding: NR Limitations: 1. Not a complete economic analysis (only diagnostic costs and no health outcomes), 2. high crossover rate, 3. lack of assignment blinding (clinician bias) 4. lack of age stratification due to the small size of sample Additional outcomes: Medications. Outcomes were reported for actual treatment as well as intention to treat (ITT). They estimate the number of extra cases of thyroid cancer in the USA associated with HCT.
Economic analysis: Cost consequences			Mean cervical spine radiation exposure (Grays)	Group 1: 294 Group 2: 389 p value: NR	
Study design Non-randomised clinical trial (allocation=alternate-day)			Mean imaging resources use (relative value unit RVU)	Group 1: 4 Group 2: 5.5 p value: <0.0001	
Duration of follow-up: Diagnosis only			Mean cost per patient (1999 US\$; radiography costs including follow-up tests)	Group 1: \$152 (£98) Group 2: \$207 (£133) p value: NR	
Discount rates: NA			Cost-effectiveness	NA	
			Sensitivity analysis	NR	

National Clinical Guideline Centre, 2014.

Study details	Patients	Interventions	Outcome measures	Effect size	Comments
	N: 72 (11 received group 1's protocol) Mean age: 6.8 M/F 45/27 Drop outs: 0				Notes: The actual differences were considerably greater than the ITT results presented here.

Table 105: Antevil 2006

Study details	Patients	Interventions	Outcome measures	Effect size	Comments
Antevil 2006 ¹⁶ USA	Patient group: all trauma patients undergoing spinal imaging	Group 1: between April 1 and June 30 of 1999 when the x-ray was the preferred technique	Sensitivity (cases of spine fractures detected)	Subgroup 1: 71% (17/24) Subgroup 2: 100% (52/52) p value: <0.001	Funding: NR
Economic analysis: cost consequences	All patients N: 573	Group 2: between April 1 and June 30 of 2002, when HCT was the preferred technique	Mean time required for X-ray+ mean time for HCT (total time) (minutes)*	Group 1: 48 (n=252) +66 (n=126)=114 Group 2: 18 (n=319) +42 (n=319)=60 p value: <0.001	Limitations: - it's not clear whether costs were adjusted for inflation - substantial cross-over - not all the outcomes refer to the same groups – sensitivity is difficult to interpret because half the patients had x-ray of the thoracic and lumbosacral spine in addition to c-spine and the reference standard is vague
Study design: Retrospective cohort study (same interval in two different years)	Group 1 N: 254 Mean age: 38 ± 1.10 Group 2 N: 319 Mean age: 37 ± 1.01	Subgroup 1: X-ray: two-view of the thoracic and lumbosacral spine and three-view cervical spine films.	Mean Charges (US \$) obtained from the hospital's charge master list and the professional fee charge list.	Subgroup 1: \$157 (£99) (n=231+21) Subgroup 2: \$1,462 (£923) (n=20+297) p value: NR	
Duration of follow-up: 48 hours after admission	Subgroup 1 (c-spine x-ray) N: 231 (from group1) + 21 (group2) Subgroup 2 (c-spine CT) N: 297 (group2) + 20 (group1)	Subgroup 2: Spiral computed tomographic scanning.	Radiation exposure (millisieverts 1 mSv = 0.1Rad) For subgroup1 calculated by radiation physicist in the hospital, for subgroup2 calculated by the CT scanner for scans of a 70 kg subject.	Subgroup 1: 4 mSv Subgroup 2: 26 mSv p value: NR	
Discount rates: NA	The number of X-rays per patient is significantly higher in the group 1 than group 2 (p<0.001).The number of HCT is significantly	Reference standard: Review of all	Mean cost per patient US \$, total radiology department costs (calculated top-down)	Subgroup 1: \$ 55 (£35) (n=231+21) Subgroup 2:\$ 57 (£36) (n=20+297) p value: NR	
			Cost-effectiveness	NR	
			Sensitivity analysis	NR	

Study details	Patients	Interventions	Outcome measures	Effect size	Comments
	higher in the group 2 than group 1 ($p < 0.001$).	available outpatient records which identified delayed or missed diagnosis of clinical significance.			

O.7.9 Diagnostic tools on cervical spine imaging -Economics evidence continued

Table 106: Frank 2002

Study details	Patients	Interventions	Outcome measures	Effect size	Comments
Frank 2002 ¹⁴⁸ USA	Patient group: children (age 0-17) with suspected cervical spine injury who were intubated at the time of hospital admission and who remained in the intensive care unit for at least 3 days.	Group 1: Not defined. MRI was performed at an average of 6.8 days after admission (before 1993).	Mean time to cervical spine clearance (days)	Group 1: 5.1 (n=46) Group 2: 3.2 (n=47) p value: 0.003	Funding: none Limitations: - intervention in the group 1 is not defined - there could be a general trend in decreased ICU and hospital days during the time period of the study - the results do not apply to the general paediatric trauma population, but only to the ICU segment - Statistical analysis not described and it is not certain that the results reported are means rather than medians. Notes:
Economic analysis: Cost			Mean intensive unit stay (days)	Group 1: 9.2 Group 2: 7.3 p value: 0.122	
Study design Cohort study (retrospective with historical control)	All patients N: 102	Group 2: MRI if cervical spine cannot be cleared within 72 hours of hospital admission.	Mean hospital stay (days)	Group 1: 20.1 Group 2: 15.5 p value: 0.106	
Duration of follow-up: Hospital stay	Group 1 N: 51 (19 requiring MRI) Age (mean): 7.2 M/F: 35/16 Drop outs: 0	MRI was performed at an average of 2.5 days after admission (after 1993).	Positive yield rate of MRI (detection of cervical spine injury)	Group 1: 3/19 (15.8%) Group 2: 4/31 (12.9%) p value: 1	
Discount rates: NA	Group 2 N: 51 (31 requiring MRI) Age (mean): 7.2 M/F: 37/14		Mean cost per patient (2000 US\$) Approximate charges for MRI, ICU and hospital stay*	Group 1: \$ 37,400 (£ 23,674) Group 2: \$ 29,700 (£ 18,800) p value: NR	
			Cost-effectiveness	NA	
			Sensitivity analysis	NR	

Study details	Patients	Interventions	Outcome measures	Effect size	Comments
	Drop outs: 0				* ICU bed (\$2,800) x average ICU days + ward bed (\$1,025) x average ward days + MRI (\$1,526) x probability of having an MRI.

Table 107: Grogan 2005

Study details	Patients	Interventions	Outcome measures	Effect size	Comments
Grogan 2005 ¹⁷⁵ USA Economic analyses: Cost-effectiveness & Cost-benefit Study design Decision analysis* Time horizon: Not defined Discount rates:	Patient group: High risk patients: focal neurological deficit, severe head injury (skull fracture, intracranial haemorrhage, or injury causing unconscious state) or high energy mechanism (high speed motor vehicle accident or pedestrian struck by car) and age over 50 and Moderate risk patients: high energy mechanism and age 50 or less, or moderate-energy mechanism (motor	Group 1: Plain Radiograph Group 2: Helical CT Scan	Paralysis due to undetected cervical spine injuries. Mean cost per patient US \$ Direct costs of each procedure (machine, labour, supplies, utilities), and settlement cost of paralysis. Data taken from the institutional radiology department. Cost-effectiveness	Group 1: 0.405% Group 2: 0.045% p value: NR With litigation costs Group 1: \$ 2,142 (£ 1,353) Group 2: \$ 554 (£ 350) p value: NR Without litigation costs Group 1: \$ 120 (£ 76) Group 2: \$ 329 (£ 208) p value: NR Cost-benefit analysis (imaging and litigation	Funding: Office of Academic Affiliations, Department of Veterans Affairs and Vanderbilt University Medical Center. Limitations: 1. It did not model the institutional costs of healthcare services related to paralysis. 2. It did not include the cost of an additional CT scan after plain radiography that would commonly occur among

Study details	Patients	Interventions	Outcome measures	Effect size	Comments
NA	vehicle accident of low or unknown speed, motorcycle accident of unknown speed, fall, or bicycle accident) and age over 50.			costs): Helical CT is cost-beneficial (direct plus indirect costs are lower) Cost-effectiveness analysis (imaging costs only): \$ 58,056 (£ 36,660) per paralysis averted	patients with positive films. Notes: The initial indirect costs are assumed to be comparable for the two procedures because they were performed in the same department. * Same model as Blackmore (1999) ^{48,49}
			Sensitivity analysis One-way sensitivity analysis (probabilities and costs were varied). Threshold analysis	CT scan is the least costly strategy if a) threshold values exceed \$58,180 for institutional settlement costs, b) there is only a 0.9% probability of c-spine fracture, or c) there is only a 1.7% probability of paralysis from a missed cervical fracture. Plain radiograph is the least costly if CT scan costs surpass \$1,918 or if plain radiograph sensitivity exceeds 90%.	

Table 108: McCulloch 2005

Study details	Patients	Interventions	Outcome measures	Effect size	Comments
McCulloch 2005 ²⁹⁴ USA Economic analysis: Cost-accuracy Study design Prospective case	Patient group: Adult patients presenting to a level I trauma centre because of either priority I or II high energy trauma. All patients N: 407	Intervention 1: Standard plain three-view radiographs of the cervical spine Intervention 1b: Standard plain three-view radiographs of the	Specificity in identifying any fracture, subluxation, or dislocation in the occiput, cervical spine, or T1 vertebra (excluding inadequate plain x-rays) Sensitivity	Intervention 1: 97% (98%) Intervention 2: 98% p value: p>0.99 Intervention 1: 45% (52%)	Funding: John Michael Moore Trauma Center, West Virginia University. Limitations: 1. Patients in the sample were not

National Clinical Guideline Centre, 2014.

Study details	Patients	Interventions	Outcome measures	Effect size	Comments
series Duration of follow-up: NA Discount rates: NA	Mean age (Range): 40 (18-91) M/F: 273/134 Drop outs: 0	cervical spine (and then HCT if radiograph is inadequate)		Intervention 2: 98% p value: p <0.001	consecutive. 2. Possible selection bias: it was reported that ISS scores were higher than the usual caseload 3. The reference standard incorporates the results of the two diagnostic tools. 4. Proportion of patients with HI not reported Additional outcomes: Mean minutes in the radiology suite: HCT was faster than plain radiography. * Estimated by NCC from study data
			Positive predictive value	Intervention 1: 74% (81%) Intervention 2: 89% p value: p <0.001	
		Intervention 2: HCT scan of the cervical spine	Negative predictive value	Intervention 1: 91% (93%) Intervention 2: 99.7% p value: p <0.001	
		Reference standard: Two radiologists independently reviewing both the HCT and plain x-ray results plus reference to hospital case notes (for example, results of MRI)	Number of cases detected	Intervention 1: 26/58 Intervention 1b: 46/58* Intervention 2: 57/58	
			Mean cost per patient Radiology charges 2004 US\$ including charge for the radiologist's review.	Intervention 1: \$ 268 Intervention 1b: \$870 Intervention 2: \$ 1151 p value: NR	
			Cost-effectiveness Incremental cost per case detected*	1b vs 1: \$12,251 (£7,736) 2 vs 1b: \$10,397 (£6,565) 1b is excluded due to extended dominance 2 vs 1: \$11,593 (£7,320)	
			Sensitivity analysis	NR	

O.7.10 Data extraction for papers describing rules for diagnosis of cervical spine injury

Table 109: Studies from original 2003 guideline

Names and evidence level	Rule description	Participants	Outcome measures	Specificity	Sensitivity	Investigation ordering rate	Prevalence	Derived using primary data	Derived using prospect. data	Validated using primary data	Validated using prospect. data	Multi-variate modelling	follow-up	Notes
Bachulis 1987 ²² Level 4 evidence Inadequate gold standard	Retrospective review of a trauma database of 4941 patients and description of those with fracture Recommend screening for all patients with altered level of consciousness or neck pain	N=94 All levels of alertness Symptomatic and asymptomatic Adults only Single USA trauma database	Fracture on plain films or follow up Gold standard : fracture on plain radiography or found after follow up	Not reported	99%	40%	94/1823 (5%)	Yes	Yes	No	No	No	No formal follow up as part of registry	One patient was missed who had his C6 fracture picked up 30 days later and needed surgery after this. No gold standard No reported follow up mechanism

Names and evidence level	Rule description	Participants	Outcome measures	Specificity	Sensitivity	Investigation ordering rate	Prevalence	Derived using primary data	Derived using prospect. data	Validated using primary data	Validated using prospect. data	Multi-variate modelling	follow-up	Notes
		Consecutive												
Baker et al (1999) ²⁴ Level 4 evidence Case series	Case series of patients with cervical spine injury Findings Neck or neurological findings in conjunction with high risk mechanism identifies all cervical spine injury 3 view plain radiographs fails to detect all injuries.	N=72 All levels of alertness Asymptomatic and symptomatic Children aged 1 month to 15 years Single USA paediatric trauma centre.	Radiographically evident cervical spine injury (RESCI) Spinal cord injury without radiographic abnormality (SCIWORA) Defined as neurology with normal	Not possible with this study type	Not possible with this study type	Not applicable	Not possible with this study type	Yes	No	No	No	No	No	This paper is a case series of positive injuries only

Names and evidence level	Rule description	Participants	Outcome measures	Specificity	Sensitivity	Investigation ordering rate	Prevalence	Derived using primary data	Derived using prospect. data	Validated using primary data	Validated using prospect. data	Multi-variate modelling	follow-up	Notes
		Non consecutive – positives only	investigations Gold standard None											
Barba et al (2001) ²⁷ Level 3 evidence Non universal gold standard	Retrospective observational cohort study Rule; Alert patients with no neurology, alcohol or distracting injury may have their C-spine cleared clinically Any patients	N=324 All levels of alertness Symptomatic and asymptomatic Adults only Single USA	Cervical spine injury Gold standard : No uniform gold standard. Protocol was followed	N/A	N/A	N/A	15 cervical spine injuries (4.6%)	Yes	Yes – the EAST guidelines were used except for CT after Head CT.	Yes	No	No	Not described	6 patients had an injury detected only on CT scanning and not on plain radiography Out of 316 patients 7 % had C-spine cleared clinically, 45% cleared

Names and evidence level	Rule description	Participants	Outcome measures	Specificity	Sensitivity	Investigation ordering rate	Prevalence	Derived using primary data	Derived using prospect. data	Validated using primary data	Validated using prospect. data	Multi-variate modelling	follow-up	Notes
	<p>not satisfying above criteria but not needing head Ct should have 3 view plain imaging and CT of any unclear areas</p> <p>Any persisting cervical pain should also have flexion-extension views</p> <p>Any further persisting pain or neurology should have MRI scan</p> <p>All of the above is in</p>	<p>trauma centre</p> <p>Consecutive</p>	<p>but negative results were not followed up</p>											<p>by 3- view radiography. (Although 30% of this group then needed CT to clarify poorly visualised areas)</p> <p>47% had lateral radiography and CT</p> <p>This paper's main conclusions are that patients undergoing a Head CT should also have a C-</p>

Names and evidence level	Rule description	Participants	Outcome measures	Specificity	Sensitivity	Investigation ordering rate	Prevalence	Derived using primary data	Derived using prospect. data	Validated using primary data	Validated using prospect. data	Multi-variate modelling	follow-up	Notes
	<p>accordance with the EAST protocol In addition:</p> <p>All those undergoing a Head CT should also have a full helical CT scan of the C-spine, and lateral plain radiography</p> <p>Their conclusion is that CT scanning using their protocol saves 17 minutes in the clearance</p>													<p>spine CT and that this would save 17 minutes in assessment.</p> <p>This paper is of little relevance to this review.</p>

Names and evidence level	Rule description	Participants	Outcome measures	Specificity	Sensitivity	Investigation ordering rate	Prevalence	Derived using primary data	Derived using prospect. data	Validated using primary data	Validated using prospect. data	Multi-variate modelling	follow-up	Notes
	of the C-spine													
Bayless et al ³³ (1989) Level 3 evidence Consecutive cohort study with universal gold standard but underpowered to support their null findings	Retrospective observational cohort study Alert asymptomatic patients may be spared radiology	N=176 All levels of alertness Symptomatic and asymptomatic Adults and children over 12 years old Single USA county hospital	Cervical spine injury on plain radiography Gold standard is injury on plain radiography or abnormality after 24 hours admission	70% (122/173)	100% (But only 3 cervical injuries found)	100% of patients received in this study Only 30% were symptomatic or non-alert.	3 cervical spine injury (1.7%)	Yes	No	No	No	No	All patients admitted for 24 hours Clinical records were reviewed to look for readmission	Only 3 fractures found in this study. No power study is presented and therefore the null findings are not supported by the authors statistical confidence in these findings.

Names and evidence level	Rule description	Participants	Outcome measures	Specificity	Sensitivity	Investigation ordering rate	Prevalence	Derived using primary data	Derived using prospect. data	Validated using primary data	Validated using prospect. data	Multi-variate modelling	follow-up	Notes
		Consecutive												
Benzel et al (1996) ⁴⁰ Level 4 evidence No gold standard to verify good outcome in MR pts	Prospective observational cohort study. MR imaging is useful for early acute post-trauma assessment in a very select group of patients.	N=174 Patients with equivocal cervical spine plain imaging or positive physical examination. Adults only Single USA university	Cervical soft tissue injuries on MRI Gold standard : None	N/A	N/A	N/A	36% had soft tissue abnormalities. 1 patient had surgical fusion, 35 had a cervical collar for 1 month, and 27 had a Minerva jacket for 2	Yes	Yes	No	No	No	No follow up of negative MRI patients to verify good outcome	No gold standard

Names and evidence level	Rule description	Participants	Outcome measures	Specificity	Sensitivity	Investigation ordering rate	Prevalence	Derived using primary data	Derived using prospect. data	Validated using primary data	Validated using prospect. data	Multi-variate modelling	follow-up	Notes
		Hospital Non-consecutive – selected group.					months							
Borock et al (1991) ⁵³ Level 3 evidence Non consecutive cohort study	Prospective observational cohort study In patients symptomatic after negative plain radiography, or where radiographs are inconclusive, inadequate or suggestive of cervical injury, CT scanning is	N=179 Alert Symptomatic Patients after plain radiography Adults and children Single	Cervical spine injury Gold standard : Cervical injury on plain radiography or CT scan	Not applicable	Not applicable	100% CT for all inconclusive plain radiographs or continued symptoms	41 of	Yes	Yes	No	No	No	Not described	The conclusion that plain radiography does not find all cervical injuries is a legitimate conclusion, but the conclusion that CT scanning is 100% sensitive is unsound as CT scanning was the gold

National Clinical Guideline Centre, 2014.

Names and evidence level	Rule description	Participants	Outcome measures	Specificity	Sensitivity	Investigation ordering rate	Prevalence	Derived using primary data	Derived using prospect. data	Validated using primary data	Validated using prospect. data	Multi-variate modelling	follow-up	Notes
	100% sensitive at detecting cervical injury	level 1 trauma centre Non-Consecutive Only patients selected after plain radiography												standard and no further follow up or imaging was universally applied or described.
Brillhart (2000) ⁶¹ Level 1 evidence	This is an abstract of the NEXUS study													
Crim et al (2001) ⁹⁰ Level 2	This is a review paper. However it is a comprehensive recent review with a treatment algorithm presented in the multi trauma patient.													

National Clinical Guideline Centre, 2014.

Names and evidence level	Rule description	Participants	Outcome measures	Specificity	Sensitivity	Investigation ordering rate	Prevalence	Derived using primary data	Derived using prospect. data	Validated using primary data	Validated using prospect. data	Multi-variate modelling	follow-up	Notes
evidence														
Davis et al ⁹⁹ (1993) Level 3 evidence Non consecutive study of missed fractures	Retrospective case series. Of 34 missed fractures 15 were due to inadequate imaging 16 were due to inadequate interpretation of films 1 had adequate films that were negative for injury 2 were of	N=740 patients with cervical injury All levels of alertness Symptomatic and asymptomatic Adults over 18 years old. 1 level 1 and 5	Missed cervical spine injury in admitted patients defined as diagnosis being made after cervical immobilisation had been removed (but prior to discharge) Gold standard	Not appropriate for this type of study	Not appropriate for this type of study	Not appropriate for this type of study	34 of 740 cervical injuries had a delayed diagnosis (4.6%)	Yes	No	No	No	No	No-no search for readmission seems to have been done. No search for those who may have been discharged with missed injury	This study describes the reasons for missed cervical spine fracture No rule described

National Clinical Guideline Centre, 2014.

Names and evidence level	Rule description	Participants	Outcome measures	Specificity	Sensitivity	Investigation ordering rate	Prevalence	Derived using primary data	Derived using prospect. data	Validated using primary data	Validated using prospect. data	Multi-variate modelling	follow-up	Notes
	indeterminate cause	level 2, USA trauma centres. Non-consecutive. Cervical injuries were found on a database of admitted patients.	: Discharge without missed fracture discovered in clinical records										has been done	
Edwards et al (2001) ¹²³ Level 2 evidence	Prospective observational cohort study All patients with sub-optimal GCS or revised	N=599 low risk patients out of a population of 1757	Cervical spine injury after 3 view radiography	31% (537/1719)	100%	69%	38 of 1757 (2.1%)	Yes	Yes	No	No	No	Follow up 3 to 6 months after discharge by	1/3rd of the total population group was excluded from the low risk study group from finding

Names and evidence level	Rule description	Participants	Outcome measures	Specificity	Sensitivity	Investigation ordering rate	Prevalence	Derived using primary data	Derived using prospect. data	Validated using primary data	Validated using prospect. data	Multi-variate modelling	follow-up	Notes
Well conducted study	<p>trauma score (RTS) should have a C-spine series and/or CT scan.</p> <p>Low risk group: Normal GCS, RTS, no distracting injuries, no abnormal laboratory investigations, no abnormal neurology on history and examination, no midline cervical tenderness – These patients do</p>	<p>GCS >13</p> <p>Low risk group defined as no neurologic deficit, not intoxicated, no extremity injuries</p> <p>GCS >13 no abnormal lab tests,</p> <p>Adults and children</p> <p>Single Dutch</p>	<p>Gold standard :</p> <p>All patients had 3-view radiography. Selected CT</p> <p>Universal follow up</p>										<p>clinic visit or telephone.</p> <p>Success of follow up not stated</p>	<p>on history or examination. This group contained 50 % of cervical spine injuries.</p> <p>Success of follow-up not given.</p>

National Clinical Guideline Centre, 2014.

Names and evidence level	Rule description	Participants	Outcome measures	Specificity	Sensitivity	Investigation ordering rate	Prevalence	Derived using primary data	Derived using prospect. data	Validated using primary data	Validated using prospect. data	Multi-variate modelling	follow-up	Notes
	not need plain radiography.	level 1 trauma centre Consecutive												
Emery et al (1989) ¹²⁷ Level 3 evidence	Study of MRI scanning after cervical injury. MRI scans were performed 10 days after injury on average and so this paper does not address guidelines for the initial assessment of injured patients													
Ersoy et al 1995 ¹²⁹ Level 4 evidence Inconsistent reference standard	Retrospective cohort study In alert and stable patients, the presence of pain or tenderness on history or examination is adequate	N=303 GCS 15 Symptomatic and asymptomatic Adults	Cervical injury on plain X-ray Gold standard : All plain X-rays were reviewed	85%	100%	19%	13 out of 303 (5%)	Yes	No	No	No	No	None	They have not described what cervical radiographs are done in their department for suspected cervical injury. No follow up so unknown if

National Clinical Guideline Centre, 2014.

Names and evidence level	Rule description	Participants	Outcome measures	Specificity	Sensitivity	Investigation ordering rate	Prevalence	Derived using primary data	Derived using prospect. data	Validated using primary data	Validated using prospect. data	Multi-variate modelling	follow-up	Notes
s	to select people for plain radiography	and children over 5 years old Single Turkish Hospital Consecutive	by a radiologist and a neurosurgeon, but types of plain X-rays not described and no follow up											there are any false negative plain radiographs.
Fischer et al (1984) ¹⁴⁴ Level 2 evidence	Retrospective cohort study Alert patients after head injury with class 1 level of consciousness but without signs or symptoms of cervical injury	N=333 with blunt head trauma Class 1 level of consciousness Symptomatic	Cervical spine injury Gold standard : Cervical spine injury on	Not evaluated	Not evaluated	Not evaluated	5 of 333 had cervical injury (1.5%) all were symptomatic	Yes	No	No	No	No	3 year follow up of all patients	Note the protocol in their department was for C-spine imaging for all people with head injury that are admitted for observation. But only 68% of patients had this

National Clinical Guideline Centre, 2014.

Names and evidence level	Rule description	Participants	Outcome measures	Specificity	Sensitivity	Investigation ordering rate	Prevalence	Derived using primary data	Derived using prospect. data	Validated using primary data	Validated using prospect. data	Multi-variate modelling	follow-up	Notes
	do not require cervical radiographic evaluation. Class 1 level of consciousness is defined as alert, responds immediately to questions may be disorientated and confused, but follows complex commands	and asymptomatic Children and adults (22mths to 77yrs) Single USA hospital Consecutive	plain radiographs or cervical injury on follow up											protocol followed in this study. The exact number of followed up patients were not described.
Freemyer et al (1989) ¹⁵¹ Level 4	Prospective observational cohort study	N=53 Level of alertness and	Cervical spine injury on 5-view cervical	N/A	N/A	N/A	33 of 53 patients (62%)	Yes	Yes	No	No	No	No follow up described in	No application of a gold standard so there could

Names and evidence level	Rule description	Participants	Outcome measures	Specificity	Sensitivity	Investigation ordering rate	Prevalence	Derived using primary data	Derived using prospect. data	Validated using primary data	Validated using prospect. data	Multi-variate modelling	follow-up	Notes
Evidence Inconsistently applied gold standard (that is, not CT and no follow up)	The addition of oblique views (a 5 view series) is of no additional benefit to the standard practise of a 3 view series in the assessment of cervical instability or injury.	symptoms not described Adults over 14 years old Single level 1 trauma centre Consecutive	plain imaging Selected patients also had CT scanning Gold standard : Results of 5 – view image, as assessed by 2 radiologists No follow up				The two oblique views did not find any additional injuries						this paper	have been injuries that were missed on both 3 and 5 view films.
Ghen et al	Paper not relevant to this review: opinion piece.													

Names and evidence level	Rule description	Participants	Outcome measures	Specificity	Sensitivity	Investigation ordering rate	Prevalence	Derived using primary data	Derived using prospect. data	Validated using primary data	Validated using prospect. data	Multi-variate modelling	follow-up	Notes
(1992) ¹⁶³ Level 5 evidence														
Gonzalez et al (1999) ¹⁶⁷ Level 2 evidence Well conducted derivation cohort study	Prospective observational cohort study Derived rule: Clinical examination of the neck can reliably rule out significant cervical injury in the awake and alert blunt trauma patient. The addition of a lateral Cervical spine X-ray is of no	N=2176 GCS 14-15 Symptomatic and asymptomatic Adults over 14 years old Single USA level 1 trauma centre	Results of clinical examination and lateral C-spine radiograph Gold Standard : Results of all imaging. Other investigations were	82% (1765/2143)	91% (30/33)	18%	33 of 2176 (1.6%) 3 had negative clinical examinations	Yes	Yes	No	No	No	All patients admitted for 24 hours. Had repeat neck examination prior to discharge, and outpatient follow up	32% of all lateral radiographs were inadequate and required further imaging

National Clinical Guideline Centre, 2014.

Names and evidence level	Rule description	Participants	Outcome measures	Specificity	Sensitivity	Investigation ordering rate	Prevalence	Derived using primary data	Derived using prospect. data	Validated using primary data	Validated using prospect. data	Multi-variate modelling	follow-up	Notes
	use. Elevated ethanol level is not a contraindication to this rule.	Consecutive	only ordered if the lateral image was inadequate. Results of follow up										was also performed.	
Hanson et al (2000) ¹⁸⁵ Level 3 evidence No universally applied gold standard	Retrospective validation study Decision rule: High risk patients for Helical CT scanning: 1. High-speed (>35mph)	N=4285 All levels of alertness Symptomatic and asymptomatic Adults	C-spine fracture on helical CT Cervical Spine fracture on plain radiography	87%	92%	601 underwent helical CT the remainder had Plain radiography, 462 of 4146 direct present	47 of 4146 1%	Yes	No – article states that rule derived by published and retrospective data	Yes	No – the discussion states that the extraction of clinical data from the notes was	No	Patient data was obtained retrospectively. No attempts at follow up of those	107 (23%) had helical CT without an indication by their criteria Abnormality rate in the low risk group was 0.2% (all low risk patients had plain imaging)

National Clinical Guideline Centre, 2014.

Names and evidence level	Rule description	Participants	Outcome measures	Specificity	Sensitivity	Investigation ordering rate	Prevalence	Derived using primary data	Derived using prospect. data	Validated using primary data	Validated using prospect. data	Multi-variate modelling	follow-up	Notes
	<p>combined impact) motor vehicle accident.</p> <p>2. Crash with death at scene of motor vehicle accident</p> <p>3. Fall from height > 3m</p> <p>4. Significant closed head injury (of ICH on CT)</p> <p>5. Neurologic symptoms or signs referred to the cervical spine.</p>	<p>over 16 years old</p> <p>Single USA trauma centre</p> <p>Consecutive</p>				ations					retrospective		<p>not under going Helical CT are documented.</p> <p>7 out of the 3684 who only had plain radiography had a cervical spine injury. But these patients were not followed up and no gold standard was applied to them to exclude a missed fracture.</p> <p>The additional fractures revealed by CT were 11 upper thoracic-spine fractures 32 proximal rib</p>	

Names and evidence level	Rule description	Participants	Outcome measures	Specificity	Sensitivity	Investigation ordering rate	Prevalence	Derived using primary data	Derived using prospect. data	Validated using primary data	Validated using prospect. data	Multi-variate modelling	follow-up	Notes
	<p>6. Pelvic or multiple extremity fractures.</p> <p>Note all patients receive plain radiography even if prior to Helical CT</p> <p>Patients only has Helical CT if also undergoing Head CT</p>													fractures 12 skull base fractures 1 mandibular fracture and Hyoid fracture.
Harris (1994) ¹⁸⁷ Level 3 evidence	This is a brief review (With 3 references)													
Harris et	Prospective	N=153	Cervical	0%	100%	100%	Only 3	No –	No	Yes	Yes	No	All	8 fluoroscopic

National Clinical Guideline Centre, 2014.

Names and evidence level	Rule description	Participants	Outcome measures	Specificity	Sensitivity	Investigation ordering rate	Prevalence	Derived using primary data	Derived using prospect. data	Validated using primary data	Validated using prospect. data	Multi-variate modelling	follow-up	Notes
al (2000) 188 Level 3 evidence This study acknowledges that it is under-powered	validation cohort study Protocol for patients with polytrauma, closed head injury or distracting injuries: C-spine trauma series, lateral, AP, Dens. If normal: NO surgery indicated: Remain in collar until MRI	Patients who could not be cleared due to altered sensorium, significant distracting injuries, or intubation. Ages not stated? Adults only Single	injury Gold standard ;			118 of 153 received intra-operative fluoroscopy	occult spinal injuries were found.	questionnaire survey of 550 surgeons in USA					were inpatients. No outpatient follow up described	evaluations could not clear the C7-T1 junction The study states that their protocol has not yet recruited enough patients to validate this protocol Therefore this paper is acknowledged to be underpowered

Names and evidence level	Rule description	Participants	Outcome measures	Specificity	Sensitivity	Investigation ordering rate	Prevalence	Derived using primary data	Derived using prospect. data	Validated using primary data	Validated using prospect. data	Multi-variate modelling	follow-up	Notes
	performed. SURGERY indicated CT scan of C-spine. If C7-T1 junction not visualised: Fluoroscopic intra-operative stretch test, followed by F/E views if stretch test negative	USA trauma centre												
Hoffman et al (1992) ²⁰⁷ Level 2 evidence	Prospective exploratory cohort study 4 factors were	N=974 All levels of alertness	C-spine fracture on plain radiography	37.3% 95% CI: 34-40%	100% 95% CI: 87-100%	Rate with this rule would be 63%	2.7% 27 fractures	Yes	Yes	No	No	No	Hospital records of radiology report	26 incomplete records were excluded from analysis (no fractures in this group)

National Clinical Guideline Centre, 2014.

Names and evidence level	Rule description	Participants	Outcome measures	Specificity	Sensitivity	Investigation ordering rate	Prevalence	Derived using primary data	Derived using prospect. data	Validated using primary data	Validated using prospect. data	Multi-variate modelling	follow-up	Notes
Well conducted exploratory study	<p>identified that could predict the presence of cervical fracture in alert patients:</p> <p>Midline neck tenderness</p> <p>Evidence of intoxication</p> <p>Altered level of alertness</p> <p>Severely painful injury elsewhere</p> <p>No combinations of symptoms</p>	<p>Symptomatic and asymptomatic</p> <p>Adults and children</p> <p>Single USA trauma centre</p> <p>Consecutive (but see notes)</p>	<p>Gold standard:</p> <p>Results of plain radiography and absence of injury on follow up</p>										<p>s were checked</p> <p>Risk management records of potential missed fractures were searched</p> <p>All final discharge diagn</p>	<p>1,342 c-spine films were taken during the study period, and there were 31 cervical fractures of which 27 were in this study. 2 of the missed C-spine fractures were not seen in A&E and 2 were not entered into the study-retrospectively reviewed and deemed to have one of the risk factors</p>

National Clinical Guideline Centre, 2014.

Names and evidence level	Rule description	Participants	Outcome measures	Specificity	Sensitivity	Investigation ordering rate	Prevalence	Derived using primary data	Derived using prospect. data	Validated using primary data	Validated using prospect. data	Multi-variate modelling	follow-up	Notes
	and signs predicted all C-spine injuries but altered level of alertness and midline tenderness identified 25 of 27 fractures												oses were searched	<p>Paper criticises itself in the discussion for low rate of C-spine fractures leading to wide confidence intervals. They suggest that their power study indicated a number of 7000 patients</p> <p>Number of views taken is not clear</p> <p>No comment on quality of</p>

Names and evidence level	Rule description	Participants	Outcome measures	Specificity	Sensitivity	Investigation ordering rate	Prevalence	Derived using primary data	Derived using prospect. data	Validated using primary data	Validated using prospect. data	Multi-variate modelling	follow-up	Notes
														films or if C7/T1 junction always visualised He describes his intent to set up the NEXUS study
Hoffman et al (1991) ²⁰⁶ Level 5 evidence	This is a brief letter, with references to papers written by Hoffman, Mower et al													
Hoffman et al for NEXUS group (2000) ²⁰⁸ Hoffman et	Prospective multi-centre observational cohort study Absence of 5 criteria are identified that will	N=34,069 patients who underwent imaging Sympto	Findings as diagnosed after 3 view plain radiography (lateral	12.9% 95% CI: 12.8 - 13.0%	99.6% 95% CI: 98.6 - 100%	87% of patients require 3 view imaging	818 (2.4%) patients had a cervical spine injury 578	Yes	Yes	Yes	Yes	Yes	Records of all centres were reviewed to find any	557 plain radiographs had inadequate 3 view films Radiographs interpreted by a designated

National Clinical Guideline Centre, 2014.

Names and evidence level	Rule description	Participants	Outcome measures	Specificity	Sensitivity	Investigation ordering rate	Prevalence	Derived using primary data	Derived using prospect. data	Validated using primary data	Validated using prospect. data	Multi-variate modelling	follow-up	Notes
<p>almethodology of NEXUS study (1998)²¹⁰</p> <p>Level 1 evidence</p> <p>Well conducted multicentre validation cohort study.</p>	<p>classify the patient as low risk:</p> <p>No midline cervical tenderness</p> <p>No focal neurologic deficit</p> <p>Normal alertness</p> <p>No intoxication</p> <p>No painful distracting injury</p>	<p>matic and asymptomatic</p> <p>All levels of alertness</p> <p>Adults and children</p> <p>21 USA hospitals</p> <p>Consecutive</p>	<p>view, antero-posterior and odontoid peg views) :</p> <p>Cervical spine injury</p> <p>Significant cervical spine injury</p> <p>Gold standard :</p>				(1.7%) patients had a clinically significant cervical spine injury.						<p>evidence of missed fractures in patients who had not been imaged.</p>	<p>radiologist at each site</p> <p>Power study performed – 737 cervical injuries to require confidence intervals of 0.5% or less. This study did not achieve this number in significant cervical spine injuries</p> <p>Of the two clinically significant missed fractures 1 had an extension-</p>

National Clinical Guideline Centre, 2014.

Names and evidence level	Rule description	Participants	Outcome measures	Specificity	Sensitivity	Investigation ordering rate	Prevalence	Derived using primary data	Derived using prospect. data	Validated using primary data	Validated using prospect. data	Multi-variate modelling	follow-up	Notes
			Results of plain radiography and absence of injury on follow up											teardrop fracture and self discharged. He was well at 6 months 1 had fracture of right lamina of 6th cervical vertebra requiring open fixation, but may have been incorrectly classified by the institution as he had loss of consciousness and neurology 2 patients were

Names and evidence level	Rule description	Participants	Outcome measures	Specificity	Sensitivity	Investigation ordering rate	Prevalence	Derived using primary data	Derived using prospect. data	Validated using primary data	Validated using prospect. data	Multi-variate modelling	follow-up	Notes
														<p>categorised by rule as high risk but fractures were initially missed on plain radiography</p> <p>Only 498 of the 818 cervical spine abnormalities were found by plain radiographs</p> <p>- Stiell et al investigated the NEXUS criteria in their population of 8924 patients and found 10</p>

Names and evidence level	Rule description	Participants	Outcome measures	Specificity	Sensitivity	Investigation ordering rate	Prevalence	Derived using primary data	Derived using prospect. data	Validated using primary data	Validated using prospect. data	Multi-variate modelling	follow-up	Notes
														<p>of 148 important injuries were missed giving a sensitivity of 93%</p> <p>They also criticise the NEXUS rule for the reproducibility of 'presence of intoxication' and 'distracting painful injuries'</p>
Holliman et al (1991) ²¹⁴ Level 3 evidence	Retrospective cohort study No cases of cervical spine injury were	N=148 All levels of alertness	Cervical fracture on lateral, odontoid peg and	N/A	N/A	N/A	100%	Yes	No	No	No	No	None although all imaging and	Small study only, no power study or confidence limits constructed

National Clinical Guideline Centre, 2014.

Names and evidence level	Rule description	Participants	Outcome measures	Specificity	Sensitivity	Investigation ordering rate	Prevalence	Derived using primary data	Derived using prospect. data	Validated using primary data	Validated using prospect. data	Multi-variate modelling	follow-up	Notes
Non-consecutive study	found on the AP view without an obvious injury on either lateral or odontoid peg views.	Symptoms not reported Age 1-89 years Single USA level 1 trauma centre and a rehabilitation centre Non-consecutive	antero-posterior views Gold standard : All images reviewed by a radiologist blinded to the original diagnosis										inpatients progress was collated	to provide further evidence for not performing Antero-posterior radiography.
Jacobs et al (1986) ²²⁹ Level 4	Prospective observational cohort study 9 factors	N=233 All levels of alertness	Cervical spine injury Gold	Physicians can predict C-spine injury	Physicians can predict C-spine injury	73% of patients in this study receive	24 out of 233 had cervical spine	Yes	Yes	No	No	Yes	No follow up described.	A quarter of patients did not have the gold standard applied.

Names and evidence level	Rule description	Participants	Outcome measures	Specificity	Sensitivity	Investigation ordering rate	Prevalence	Derived using primary data	Derived using prospect. data	Validated using primary data	Validated using prospect. data	Multi-variate modelling	follow-up	Notes
evidence Inconsistently applied gold standard	predict C-spine injury: HISTORY: fall less than 10 feet is protective. EXAMINATION: Numbness, loss of sensation, Weakness. SIGNS: Neck spasm, Neck tenderness, loss of power, decreased sensation, loss of anal tone Any of these factors requires 3 view C-spine views.	Symptomatic and asymptomatic Adults only Single USA trauma centre Consecutive	standard : Minimum of lateral view and AP view – assessed independently by two radiologists.	with specificity of 94% All factor rule specificity is 38%	with sensitivity of 46% All factor rule sensitivity is 100%	d imaging	injury (10.4%)						Of note only 73% received imaging	

Names and evidence level	Rule description	Participants	Outcome measures	Specificity	Sensitivity	Investigation ordering rate	Prevalence	Derived using primary data	Derived using prospect. data	Validated using primary data	Validated using prospect. data	Multi-variate modelling	follow-up	Notes
Jen et al (2001) ²³² Level 3 Evidence Non consecutive study	Retrospective Cohort study Plain radiography is less sensitive than helical CT scanning and should therefore be considered to be the standard modality in these cases	N=604 Alertness and consciousness level data not given Single USA trauma centre Non consecutive	Fracture of 4 view plain radiography Fracture on Helical CT Gold Standard : Fracture on Helical CT	Not given	33%	N/A	30/604 (5%) had a fracture Only 10 of these seen on plain films	Yes	No	No	No	No	None	Only 604 of 3684 patients undergoing plain radiography also underwent helical CT scanning. These patients were selected for the study.
Keenan et al (2001) ²⁴³ Level 3	Study not relevant to this review. This study looks at the reduction of plain radiographs to clear the C-spine are ordered when a full CT of the C-spine is done. NO assessment of the sensitivities or specificities													

Names and evidence level	Rule description	Participants	Outcome measures	Specificity	Sensitivity	Investigation ordering rate	Prevalence	Derived using primary data	Derived using prospect. data	Validated using primary data	Validated using prospect. data	Multi-variate modelling	follow-up	Notes
evidence	of each modality													
Klein et al ²⁵² (1998) Level 4 evidence Non-consecutive Case series,	Retrospective case series To compare MRI to CT scanning for Bony injuries MRI is neither as sensitive nor as specific as CT scanning for bony abnormality.	N=42 Patients with cervical fracture confirmed on CT scan Adults over 15 years Single USA level 1 trauma centre Non consecutive	Posterior element cervical fracture Gold standard : CT scanning evaluated by 2 radiologists.	97%	Sensitivity 11.5%	100%	76%	Yes	No	No	No	No	No	Demonstrates that MRI misses 90% of posterior element fractures in the cervical spine
Kreipke	Prospective	N= 860	Cervical	39%	100%	Their	24 out	Yes	Yes	No	No	No	No	

Names and evidence level	Rule description	Participants	Outcome measures	Specificity	Sensitivity	Investigation ordering rate	Prevalence	Derived using primary data	Derived using prospect. data	Validated using primary data	Validated using prospect. data	Multi-variate modelling	follow-up	Notes
et al (1989) ²⁵⁵ Level 3 evidence Non-consecutive study	observational cohort study Cervical spine radiography should be performed in patients with abnormal neurologic findings or symptoms referable to the neck. In alert asymptomatic patients, cervical spine radiography may be omitted.	All levels of alertness Symptomatic and asymptomatic Assumed to be Adults only Single USA level 1 trauma centre Non - Consecutive as the	spine fracture Gold standard : Findings on lateral, A-P, open mouth and Weir pillar views interpreted by one of the three radiologist authors of this paper.	(324/836)		ordering rate would be 62% with this rule.	of 860 had fracture or dislocation (2.8%)							

Names and evidence level	Rule description	Participants	Outcome measures	Specificity	Sensitivity	Investigation ordering rate	Prevalence	Derived using primary data	Derived using prospect. data	Validated using primary data	Validated using prospect. data	Multi-variate modelling	follow-up	Notes
		study is only of patients who were sent for radiography (criteria not detailed)												
Kriss et al (1996) ²⁵⁷ Level 3 evidence	This is a review													
Link et al (1994- in German) and (1995) ^{274, 275}	Study to evaluate the usefulness of routine CT of the cranio-cervical junction in unconscious	N=202 patients with substantial cranial trauma	C1 or C2 fracture on CT Gold Standard :	N/A	N/A	100% CT	18.3% atlas, axis or occipital condyl e fractur	Yes	Yes	No	No	No	None descri bed	Unclear as to what percentage of patients had plain radiography.

Names and evidence level	Rule description	Participants	Outcome measures	Specificity	Sensitivity	Investigation ordering rate	Prevalence	Derived using primary data	Derived using prospect. data	Validated using primary data	Validated using prospect. data	Multi-variate modelling	follow-up	Notes
Level 3 Non consecutive study	patients with severe head injury. 28 patients had a C-1 or C-2 fracture, and 11 of these were missed on plain radiographs. Recommend CT of cranio-cervical junction in all patients with severe head trauma.	GCS 3-6 Without obvious symptoms indicating cervical trauma Age 3-86 Single German hospital Non-consecutive cohort	Fracture on CT. Images were reviewed by attending trauma team and radiologist then a second blinded radiologist reviewed the films				es.							
Macdonald et al (1990) ²⁸⁵	Retrospective observational cohort study	N=775 patients post MVA.	Cervical injury on 3-view radiogra	97%	83%	Not applicable	92 out of 775 (12%)	Yes	No	No	No	No	All patients are routin	Minimal clinical details were taken regarding the

Names and evidence level	Rule description	Participants	Outcome measures	Specificity	Sensitivity	Investigation ordering rate	Prevalence	Derived using primary data	Derived using prospect. data	Validated using primary data	Validated using prospect. data	Multi-variate modelling	follow-up	Notes
Level 2 evidence Well conducted study	Single lateral C-spine radiograph is not adequate to exclude cervical injury in patients after Motor Vehicle Accidents. Cervical clearance can be obtained by 3 view plain radiography, but there is still a 1 % chance of missing significant injury	All levels of alertness Symptomatic and asymptomatic. Adults over 18 years old Single USA regional trauma unit. Consecutive	phy Gold standard : Cervical injury on all radiography performed. And clinical follow up										ely followed up by neurosurgeons. Although they do not state the number of patients that were verified as asymptomatic.	patient's history and examination even though 50% of these patients were GCS 15.
Maurice	This paper investigates the effects of													

Names and evidence level	Rule description	Participants	Outcome measures	Specificity	Sensitivity	Investigation ordering rate	Prevalence	Derived using primary data	Derived using prospect. data	Validated using primary data	Validated using prospect. data	Multi-variate modelling	follow-up	Notes
et al (1996) ²⁹³ Level 3 evidence	implementing C-spine guidelines in a UK Emergency department In terms of X-ray requests Study not relevant to this review													
Mcnamara et al (1990) ²⁹⁸ Level 4 evidence Non-independent gold standard	Retrospective observational cohort study Rule: Alert non-intoxicated, asymptomatic victims of blunt trauma do not need plain radiography.	N=286 GCS 13-15 Symptomatic and asymptomatic (178) Adults only Single USA level II trauma centre	Cervical spine fracture Gold standard: The radiologists interpretation of all cervical radiography or other diagnostic	63% (178/281)	100%	Would require a 63% ordering rate	5 fractures (1.7%)	Yes	No	No	No	No	No follow up (see notes)	115 patients excluded due to poor documentation, Inadequate follow up 45% of the asymptomatic patients had any imagines and 37% of these were just single lateral c-spine views. Gold standard not

National Clinical Guideline Centre, 2014.

Names and evidence level	Rule description	Participants	Outcome measures	Specificity	Sensitivity	Investigation ordering rate	Prevalence	Derived using primary data	Derived using prospect. data	Validated using primary data	Validated using prospect. data	Multi-variate modelling	follow-up	Notes
		Consecutive	c imaging											applied to large number of patients.
McNamara et al (1988) ²⁹⁹ Level 4 evidence Non-consecutive study with inconsistent reference standards	Prospective observational cohort study The presence of immediate neck pain or posterior midline cervical tenderness was 100 % sensitive at predicting the 7 cervical spine fractures	N= 351 All levels of alertness Symptomatic and asymptomatic Adults only 3 USA urban hospitals Non-	Cervical injury Gold Standard : Plain radiography and post discharge follow up.	No rule derived	No rule derived	No rule derived	7 cervical injuries (2%)	Yes	Yes	No	No	No	Followed up by phone or letter 58% successfully followed up	66 % of all discharged patients were pursuing litigation over accident. The authors stated that this severely limited their ability to identify further factors related to cervical injury. 446 patients met entry criteria but did not have radiography

Names and evidence level	Rule description	Participants	Outcome measures	Specificity	Sensitivity	Investigation ordering rate	Prevalence	Derived using primary data	Derived using prospect. data	Validated using primary data	Validated using prospect. data	Multi-variate modelling	follow-up	Notes
		Consecutive as physician participation was voluntary among those collecting the data												were not adequately followed up.
Mower et al for NEXUS group (2001) ³²⁸ Level 1 evidence Well conducted study	436 missed injuries in 237 patients were in cases where plain radiography was abnormal or inadequate But 23 patients were missed with adequate films	N=34,069 patients who underwent imaging All levels of alertness Symptomatic	Findings as diagnosed after 3 view plain radiography (lateral view, antero-posterior and odontoid	Not appropriate in this paper	Not appropriate in this paper	Not appropriate in this paper	23 patients had injuries that were not visualised on adequate plain film imaging	Yes	Yes	Yes	Yes	No	Records of all centres were reviewed to find any evidence of missed fracture	Paper illustrating a major weakness in the NEXUS study

Names and evidence level	Rule description	Participants	Outcome measures	Specificity	Sensitivity	Investigation ordering rate	Prevalence	Derived using primary data	Derived using prospect. data	Validated using primary data	Validated using prospect. data	Multi-variate modelling	follow-up	Notes
	Only 498 of the 818 cervical spine injuries were found on plain radiographs.	and asymptomatic Adults and children 21 USA hospitals Consecutive	peg views): Cervical spine injury Significant cervical spine injury Gold standard: Results of plain radiography and absence of injury				including 3 potentially unstable injuries.						res in patients who had not been imaged.	

Names and evidence level	Rule description	Participants	Outcome measures	Specificity	Sensitivity	Investigation ordering rate	Prevalence	Derived using primary data	Derived using prospect. data	Validated using primary data	Validated using prospect. data	Multi-variate modelling	follow-up	Notes
			on follow up											
Neifeld et al (1988) ³⁴⁶ Level 3 evidence No independent and universal gold standard	Prospective observational cohort study Rule: All patients with altered mental status, abnormal examination findings distracting injury, or pain or tenderness over the cervical spine need plain radiography. Asymptomatic patients or those with tenderness	N=886 All levels of alertness Symptomatic and asymptomatic (244) Adults over 14 years old 4 Canadian Hospitals Consecut	Cervical spine fracture or dislocation Gold standard : Cervical spine injury diagnosed by a radiologist after 5 view plain radiography.	19%	100%	All patients were radiographed in this study. Rule would require 73% plain radiography	28 out of 886 (3%)	Yes	Yes	No	No	No	No follow up but all patients got 5 view radiography	30 patients excluded due to incomplete datasheets

Names and evidence level	Rule description	Participants	Outcome measures	Specificity	Sensitivity	Investigation ordering rate	Prevalence	Derived using primary data	Derived using prospect. data	Validated using primary data	Validated using prospect. data	Multi-variate modelling	follow-up	Notes
	limited to the trapezius may be cleared clinically.	ive												
Panacek et al for NEXUS group (2001) ³⁷⁷ Level 1 evidence Well conducted validation cohort study	Sub-study of NEXUS database to look at each of the 5 criteria identified in the NEXUS study None of the 5 criteria may safely be removed without missing significant Cervical spine injury. Absence of 5	N=34,069 All levels of alertness Symptomatic and asymptomatic Adults and children 21 USA trauma centres	Any C-spine fracture on plain radiography Significant C-spine fracture on plain radiography Gold standard :	12.9% 95% CI: 12.8 - 13.0%	99.6% 95% CI: 98.6% - 100%	87% of patients require 3 view imaging	818 (2.4%) patients had a cervical spine injury 578 (1.7%) patients had a clinically significant cervical spine injury.	Yes	Yes	Yes	Yes	No	As for NEXUS study	Paper is a sub-study of NEXUS study further demonstrating that their 5 criteria are the optimal tool for detecting C-spine injury

Names and evidence level	Rule description	Participants	Outcome measures	Specificity	Sensitivity	Investigation ordering rate	Prevalence	Derived using primary data	Derived using prospect. data	Validated using primary data	Validated using prospect. data	Multi-variate modelling	follow-up	Notes
	<p>criteria are identified that will classify the patient as low risk:</p> <p>No midline cervical tenderness</p> <p>No focal neurologic deficit</p> <p>Normal alertness</p> <p>No intoxication</p> <p>No painful distracting injury</p>	Consecutive	Results of plain radiography and absence of injury on follow up											

Names and evidence level	Rule description	Participants	Outcome measures	Specificity	Sensitivity	Investigation ordering rate	Prevalence	Derived using primary data	Derived using prospect. data	Validated using primary data	Validated using prospect. data	Multi-variate modelling	follow-up	Notes
<p>Pollack et al (2001) For NEXUS⁴⁰¹</p> <p>Level 2 evidence</p> <p>Well conducted observational study</p>	<p>Prospective multi-centre observational cohort study secondary analysis: to assess the utility of flexion extension views.</p> <p>Flexion/extension views should be delayed until 10-14 days after injury and MRI should be used to evaluate possible ligamentous</p>	<p>N=818 patients with a fracture</p> <p>All levels of alertness</p> <p>Symptomatic and asymptomatic</p> <p>Adults and children</p> <p>21 USA trauma centres</p> <p>This sub</p>	<p>Cervical injury diagnosed on flexion extension views that were not seen on plain imaging</p> <p>Gold standard:</p> <p>Results of all types of radiography and absence</p>	Not applicable	Not applicable	86 of 818 patients with a fracture had F/E views	0.7% of 818 patients who had a Cervical spine injury had an injury seen only on the flexion extension views. 86 FE views had been requested in this group. All	Yes	Yes	No	No	No	<p>Hospital records of radiology reports were checked</p> <p>Risk management records of potential missed fractures were search</p>	<p>The number of negative F/E views performed in the whole population of 34,000 patients was not assessed</p> <p>4 of 16 subluxations were also only seen on F/E views, but the plain imaging had other abnormalities that required imaging by CT/ MRI which would therefore have resulted in their</p>

National Clinical Guideline Centre, 2014.

Names and evidence level	Rule description	Participants	Outcome measures	Specificity	Sensitivity	Investigation ordering rate	Prevalence	Derived using primary data	Derived using prospect. data	Validated using primary data	Validated using prospect. data	Multi-variate modelling	follow-up	Notes
	instability	analysis is non-Consecutive in that it is only the fracture patients.	of injury on follow up				these (4) fractures were stable.						ed All final discharge diagnoses were searched	detection.
Ptak et al (2001) ⁴⁰⁶ Level 2 evidence Well conducted retrospective derivatio	Retrospective cohort Screening Helical CT scanning is highly sensitive and specific in diagnosing clinically relevant fractures.	N= 676 Alertness and consciousness level data not given Single USE trauma centre	Fracture on helical CT scanning. A Helical CT scanning protocol was initiated for the identification of patients	100%	98.3	100%	60/676 (8.8%)	Yes	No	NO	NO	NO	Yes, there was note review of on ward progress	1 patient had a negative CT but had further neck pain and repeat imaging found an undisplaced type II fracture of the odontoid peg

Names and evidence level	Rule description	Participants	Outcome measures	Specificity	Sensitivity	Investigation ordering rate	Prevalence	Derived using primary data	Derived using prospect. data	Validated using primary data	Validated using prospect. data	Multi-variate modelling	follow-up	Notes
n cohort study		Consecutive	for scanning. Gold standard : Helical CT and Follow-up											
Roberge et al (1988) ⁴²⁰ Level 2 evidence Well conducted study	Prospective observational cohort study Alert trauma victims with no complaints of neck discomfort upon questioning and with no tenderness on neck	N=467 All levels of alertness Symptomatic and asymptomatic Adults over 16	Cervical spine injury Gold standard : 5 view cervical spine radiographs interpret	45% 95% CI: 45- 50%	100% 95% CI: 55- 100%	Their rule would have resulted in an 89% ordering rate	8 out of 467 had cervical injury (1.7%)	Yes	Yes	No	No	No	All patients were seen in a follow up clinic	Well-conducted study but low number of positive patients has resulted in an underpowered conclusion.

Names and evidence level	Rule description	Participants	Outcome measures	Specificity	Sensitivity	Investigation ordering rate	Prevalence	Derived using primary data	Derived using prospect. data	Validated using primary data	Validated using prospect. data	Multi-variate modelling	follow-up	Notes
	palpation need not undergo Cervical Spine radiography.	years old Single USA level 1 trauma centre Consecutive	ed by radiographer, or positive follow up											
Roberge et al (1992) ⁴¹⁹ Level 3 evidence Study admits to being under-powered .	Prospective observational study The absence of neck discomfort tenderness or neurological deficits does not exclude cervical spine injury.	N=480 All levels of alertness (considered separately) Symptomatic and Asymptomatic	Cervical spine injury Gold standard : Cervical spine injury as diagnosed by a	16% 95% CI: 13-20%	93% 95% CI: 75 - 100%	100% received 5 view plain radiography (3 view plus oblique views)	17 had cervical spine injury (3.5%)	Yes	Yes	No	No	No	Discharged patients were scheduled for follow up by their own private physician or	Underpowered study. Plain radiography but not follow up was used as gold standard

Names and evidence level	Rule description	Participants	Outcome measures	Specificity	Sensitivity	Investigation ordering rate	Prevalence	Derived using primary data	Derived using prospect. data	Validated using primary data	Validated using prospect. data	Multi-variate modelling	follow-up	Notes
		Adults over 16 years Single USA trauma centre Consecutive	radiologist after 5 view plain radiography										surgey clinic. Their good outcome was not verified by this study.	
Rosenberg (1994) ⁴²⁴ Level 4 evidence	No original data in this article – case studies.													
Ross et al (1992) ⁴²⁷ Level 2 evidence	Prospective observational study Immediate	N=410 All levels of consciousness	Cervical injury on 3 view plain radiography	49% 196/397	100% 13/13	51%	13 out of 410 (6%) had unstable	Yes	Yes	No	No	No	All patients were followed up	Number of patients successfully followed up not stated

National Clinical Guideline Centre, 2014.

Names and evidence level	Rule description	Participants	Outcome measures	Specificity	Sensitivity	Investigation ordering rate	Prevalence	Derived using primary data	Derived using prospect. data	Validated using primary data	Validated using prospect. data	Multi-variate modelling	follow-up	Notes
Well conducted observational study	radiographic investigation of the cervical spine is mandatory in all patients with: Loss or defect in conscious level, neurological deficit, neck tenderness. Imaging is not necessary in the absence of these signs.	ness Symptomatic and asymptomatic Adults and children over 12 years old Single USA trauma centre Consecutive	Gold standard : Positive radiological findings or positive findings at follow up				injuries .						for at least 2 weeks after discharge	
Roth et al (1994) ⁴²⁸	Prospective observational study.	N=682 96 Alert	Cervical spine injury	11% (96/890)	100%	100% of patients were	16 patients	Yes	Yes	No	No	No	43% were follow	Small study number of alert

National Clinical Guideline Centre, 2014.

Names and evidence level	Rule description	Participants	Outcome measures	Specificity	Sensitivity	Investigation ordering rate	Prevalence	Derived using primary data	Derived using prospect. data	Validated using primary data	Validated using prospect. data	Multi-variate modelling	follow-up	Notes
Level 2 evidence Well conducted study	Rule Blunt trauma patients do not require cervical imaging if they have: Absence of mental status changes, intoxication, neck pain or tenderness, neurologic signs or symptoms, or simultaneous major distracting injury.	and Asymptomatic patients Presumed to be adults Single Hawaiian military hospital Consecutive	Gold standard : All patients received plain 3 view imaging and follow up (see later))		imaged in this study.	(2%)						ed up and of those not followed up, none were readmitted. (This is the only hospital in a 2500 mile radius of Hawai i)	asymptomatic patients bearing in mind the 2% prevalence of positives.
Saddison et al (1991) ⁴³⁴	Retrospective case series All alert	N=79 Class 1 level of	Cervical spine injury on discharg	N/A	N/A	N/A	100%	Yes	No	No	No	No	No	No discussion of how the diagnoses were made or

National Clinical Guideline Centre, 2014.

Names and evidence level	Rule description	Participants	Outcome measures	Specificity	Sensitivity	Investigation ordering rate	Prevalence	Derived using primary data	Derived using prospect. data	Validated using primary data	Validated using prospect. data	Multi-variate modelling	follow-up	Notes
Level 4 evidence Small retrospective with inconsistent reference standards	patients with cervical injury can be detected by imaging only those with cervical pain or tenderness.	consciousness (alert, responds to questions, may be disoriented or confused) Symptomatic or asymptomatic Age range 10 to 84 years old Single USA medical	e diagnosis retrospectively found from hospital records. Gold standard : None											if any patients were discharged with a missed diagnosis. Also no attempt to verify that the hospital discharge diagnosis was 100% accurate.

Names and evidence level	Rule description	Participants	Outcome measures	Specificity	Sensitivity	Investigation ordering rate	Prevalence	Derived using primary data	Derived using prospect. data	Validated using primary data	Validated using prospect. data	Multi-variate modelling	follow-up	Notes
		centre Non consecutive												
Schnarkowski et al ⁴⁴² (1991) Level 3 evidence Non-consecutive	Retrospective cohort To rule out cervical injuries in patients with incomplete visualisation of the cervical spine, cervical CT should be performed in addition to 3 view radiographs	N=100 Unclear alertness or GCS Single German Hospital Non Consecutive	Fracture on Plain radiography or CT Gold standard CT of C-spine	Unclear	Unclear	Unclear	15/100 (15%) 3 of these were only found by CT	Yes	No	No	No	No	Unclear	This article is in German
Schroder et al (1995) ⁴⁴⁷	Retrospective cohort study	N=39 Case mix	Cervical injury on Ct or MRI	N/A	N/A	N/A	100%	Yes	No	NO	No	No	Unknown	CT found 100% of all osseous injuries but

National Clinical Guideline Centre, 2014.

Names and evidence level	Rule description	Participants	Outcome measures	Specificity	Sensitivity	Investigation ordering rate	Prevalence	Derived using primary data	Derived using prospect. data	Validated using primary data	Validated using prospect. data	Multi-variate modelling	follow-up	Notes
Level 3 evidence Non consecutive study	MRI is the investigation of choice after primary imaging except if the patient is undergoing CT for other reasons	unknown Ages unknown Single German hospital Non consecutive	scan Gold standard Results from CT or MRI only, follow up unknown											only 33% of longitudinal ligament injuries MRI identified all the soft tissue injuries but only 50% of C2 fractures, 89% of transverse process fractures, 92% of lamina fractures This paper is in German
Stiell et al (2001) ⁴⁹⁹ Level 2	Prospective derivation observational cohort study 3 questions	N= 8924 patients who underwent imaging	Important cervical spine injury on 3-view plain	42.5% 95% CI: 40- 44%	100% 95% CI: 98 -	58.2% radiography rate would be	151 (1.7%) had clinically import	Yes	Yes	No	No	Yes	All patients who did not	3281 patients out of 12782 were examined by physicians at the study sites

National Clinical Guideline Centre, 2014.

Names and evidence level	Rule description	Participants	Outcome measures	Specificity	Sensitivity	Investigation ordering rate	Prevalence	Derived using primary data	Derived using prospect. data	Validated using primary data	Validated using prospect. data	Multi-variate modelling	follow-up	Notes
evidence - N.B. validation study is in press Well conducted derivation cohort study	were derived for categorisation of patients: 1. This there any high risk factor present that mandates radiography: age >65, dangerous mechanism, or paraesthesia in the extremities? 2. Is there a low risk factor present that allows the safe	Alert, GCS 15 and cardiovascular stability Symptomatic and asymptomatic Adults over 16 years old 10 large community and university hospitals	radiography (All injuries except: isolated avulsion fracture of an osteophyte, isolated fracture of a transverse process not involving a facet joint, isolated fracture of a spinous process		100% In addition the rule would find 27 of the 28 unimportant cervical spine injuries	achieved with this rule.	ant Cervical spine injury. Also 28 unimportant injuries were found						have plain radiography underwent a 14-day proxy outcome measure interview by telephone. 577 could not be reached and were thus	but not enrolled representing 25% of possible patients. These patients had a higher rate of C-spine injury (3.2% vs 2.0%) The 4.5% of patients that were not traced by telephone were not further investigated. Coroner's records or the records of other hospitals could have

Names and evidence level	Rule description	Participants	Outcome measures	Specificity	Sensitivity	Investigation ordering rate	Prevalence	Derived using primary data	Derived using prospect. data	Validated using primary data	Validated using prospect. data	Multi-variate modelling	follow-up	Notes
	assessment of range of motion (that is, simple rear-end motor vehicle collision, sitting position in ED, ambulatory at any time since injury, delayed onset of neck pain, absence of midline C-spine tenderness? 3. Is the patient able to actively rotate neck to 45 degrees to the left	Consecutive	not involving the lamina, compression fracture of less than 25% of the vertebral body height Gold standard : Results of plain radiography and absence of injury										excluded from the study	been checked. If you assume that this group has the same incidence of fracture as the study cohort then $577 \times 1.7\% = 10$ patients would have been missed. If the incidence was actually 10 times less than the cohort 1 patient would still have been missed.

Names and evidence level	Rule description	Participants	Outcome measures	Specificity	Sensitivity	Investigation ordering rate	Prevalence	Derived using primary data	Derived using prospect. data	Validated using primary data	Validated using prospect. data	Multi-variate modelling	follow-up	Notes
	and right?		on follow up											
Williams et al (1992) ⁵³⁴ Level 4 evidence Inconsistent references	Retrospective observational cohort study Trauma to the head, face or clavicles is not associated with higher rate of C-spine injury. GCS less than 14 is associated with an increased risk of injury No rule derived	N=5021 All levels of alertness Symptomatic and asymptomatic Age not stated Single USA level 1 trauma centre Consecutive	Cervical spine injury as coded by ICD-9 on database . Gold Standard : None	No rule	No rule	Not studied	227 had cervical spine injury (4.5%) GCS 14 and 15 – 3.9% GCS under 14 – 6.7% cervical spine injuries	Yes	No	No	No	No	No	Only 3915 patients had a GCS score recorded, with head injured patients more likely to have the GCS recorded on their database. Minor trauma patients who were not admitted were not included, as they are not entered into the database. Fatal victims

Names and evidence level	Rule description	Participants	Outcome measures	Specificity	Sensitivity	Investigation ordering rate	Prevalence	Derived using primary data	Derived using prospect. data	Validated using primary data	Validated using prospect. data	Multi-variate modelling	follow-up	Notes
														were also included.
Woodring et al (1993) ⁵³⁶ Level 3 evidence Non-consecutive study	Retrospective cohort study Cervical radiography cannot be relied upon to determine the extent of cervical injury. High risk patients, and all those with positive or inconclusive plain films should all have CT scanning	N=216 87% were asymptomatic and alert Ages not stated Single USA Hospital Non-Consecutive only patients with cervical	Cervical spine injury Method for identifying their cases not stated Gold standard : 100% of patients received lateral AP and odontoid views. 100% received CT	Not applicable	Not applicable	Not applicable	Plain radiography detected only 33% of fractures and 55% of subluxations on initial evaluation. 85% of the fractures were deemed to be present on the	Yes	No	No	No	No	No	Retrospective analysis of case notes to determine the presence of clinical symptoms and signs on presentation to the emergency department. However these 'asymptomatic' patients still had further imaging after plain radiography so there must have been clinical indications for

National Clinical Guideline Centre, 2014.

Names and evidence level	Rule description	Participants	Outcome measures	Specificity	Sensitivity	Investigation ordering rate	Prevalence	Derived using primary data	Derived using prospect. data	Validated using primary data	Validated using prospect. data	Multi-variate modelling	follow-up	Notes
		injury were studied	scanning. Films assessed independently by two radiologists				plain films retrospectively							these.
Zabel et al (1997) ⁵⁴¹ Level 4 evidence Inconsistent reference standards	Retrospective cohort study Patients who have sustained blunt trauma and are alert do not need a lateral cervical radiograph in the initial evaluation of cervical spine injury, in contradiction	N=353 GCS >13 Symptomatic and asymptomatic Adults over 15 years old. Single	Cervical injury on plain radiography Gold standard : None	58% for lateral radiograph	67% for lateral radiograph	42%	9 out of 353 (2.4%) had cervical injury, only 6 found on lateral C-spine	Yes	No	No	No	No	No follow up reported	379 out of a possible 1807 were deemed to be eligible for inclusion in the study Only 63% of lateral cervical spine radiographs were deemed adequate. Lack of gold standard or follow up so

Names and evidence level	Rule description	Participants	Outcome measures	Specificity	Sensitivity	Investigation ordering rate	Prevalence	Derived using primary data	Derived using prospect. data	Validated using primary data	Validated using prospect. data	Multi-variate modelling	follow-up	Notes
	to standard ATLS teaching	USA level 1 trauma centre Consecutive												the absence of missed cervical injury cannot be excluded.

O.7.11 The Utility of Flexion/Extension views

Table 110: Studies from original 2003 guideline

Names and evidence level	Rule description	Participants	Outcome measures	Specificity	Sensitivity	Investigation ordering rate	Prevalence	Derived using primary data	Derived using prospect. Data	Validated using primary data	Validated using prospect. Data	Multi-variate modelling	Follow-up	Notes
Anglen 2001 ¹⁵ Level 4 evidence Non-independent reference standards	Retrospective cohort study Flexion Extension is not a useful part of a protocol for clearance of the cervical spine in the patients that are not fully conscious or comatose patient.	N=837 patients after Flexion Extension view radiographs Not fully conscious or comatose patients Ages not stated Single	Cervical spine injury Gold standard : No uniform gold standard applied. Only positive F/E results were followed up.	Not applicable	Not applicable	Not applicable	4 patients with negative plain films and/or CT scanning had positive F/E views. 1 false positive, 1 lost to follow up 2 had good	Yes	No	No	No	No	No	1484 Flexion extension views were done at this institution. 407 were deemed inadequate 57 were missing 919 were negative There were 39 positive reports but only 4 of these reports met the study inclusion

National Clinical Guideline Centre, 2014.

Names and evidence level	Rule description	Participants	Outcome measures	Specificity	Sensitivity	Investigation ordering rate	Prevalence	Derived using primary data	Derived using prospect. Data	Validated using primary data	Validated using prospect. Data	Multi-variate modelling	Follow-up	Notes
		USA trauma centre Non consecutive					outcome with conservative Rx							criteria of coma, and negative other imaging. No confirmatory test was applied to those with negative F/E views and no follow up
Brady et al (1999) ⁵⁶ Level 4 evidence Non-consecutive study	Retrospective cohort study Blunt trauma patients with abnormal static radiography are more likely to have abnormal	N=451 All levels of alertness Symptoms not reported	Cervical injury on lateral, AP, peg and flexion Extension views. Gold standard	N/A	N/A	N/A	79 out of 451 (17.5%) 2 patients with SCIWORA	Yes	No	No	No	No	None performed	No gold standard applied and authors acknowledge this deficiency and call for further larger studies with a universal gold standard

Names and evidence level	Rule description	Participants	Outcome measures	Specificity	Sensitivity	Investigation ordering rate	Prevalence	Derived using primary data	Derived using prospect. Data	Validated using primary data	Validated using prospect. Data	Multi-variate modelling	Follow-up	Notes
, without adequate gold standard	dynamic radiography that requires stabilisation.	Adults over 18 years old Single USA trauma centre Non consecutive	: None applied											
Clancy (1999) ⁸⁰ Level 3 evidence	This is a UK review article but is pre NEXUS and Stiell's work													
Lewis et al (1991) ²⁷⁰ Level 4 evidence	Retrospective cohort study No conclusion drawn.	N=141 All levels of alertness	All Patients had F/E views performed after 3 view	93%	99%	100%	11 out of 141 had cervical instability (8%)	Yes	No	No	No	No	No follow up protocol was described	No gold standard, No follow up protocol described

National Clinical Guideline Centre, 2014.

Names and evidence level	Rule description	Participants	Outcome measures	Specificity	Sensitivity	Investigation ordering rate	Prevalence	Derived using primary data	Derived using prospect. Data	Validated using primary data	Validated using prospect. Data	Multi-variate modelling	Follow-up	Notes
Non-independent Gold standard	<p>Authors call for larger study.</p> <p>Flexion Extension found 4 patients who required surgical stabilisation who had normal plain radiography, but there was one false negative F/E view also</p>	<p>Adults only</p> <p>Single USA level 1 trauma centre</p> <p>Non-consecutive – F/E views were ordered at physician's discretion.</p>	<p>plain series</p> <p>Gold standard :</p> <p>None. Other radiological tests were performed at the discretion of the physician. No follow up</p>				<p>4 of these not seen on plain views</p> <p>1 false negative result</p>							<p>One patient with a negative F/E view went on to need cervical stabilising surgery.</p>
Mirvis et al (1995) ³¹³	This is a review article													

Names and evidence level	Rule description	Participants	Outcome measures	Specificity	Sensitivity	Investigation ordering rate	Prevalence	Derived using primary data	Derived using prospect. Data	Validated using primary data	Validated using prospect. Data	Multi-variate modelling	Follow-up	Notes
Level 3 evidence														
Palmer et al (1995) ³⁷⁶ Level 3 evidence	This study looks at the effect of ATLS training in the implementation of cervical spine protocols. Irrelevant to this review													
Ralston et al (2001) ⁴¹⁰ Level 3 evidence Small study non-consecutive	Retrospective cohort study In patients with normal plain radiography, flexion Extension views are of limited value. In a subset of	N=129 patients who had undergone plain and F/E radiography No injury severity reported	Cervical injury on plain (AP and lateral only) and Flexion Extension views Gold standard :	N/A	N/A	N/A	83 of 129 (64%)	Yes	No	No	No	No	Not reported	F/E views had one false positive F/E views showed no abnormalities in 75 of 83 patients with suspicious plain radiography

National Clinical Guideline Centre, 2014.

Names and evidence level	Rule description	Participants	Outcome measures	Specificity	Sensitivity	Investigation ordering rate	Prevalence	Derived using primary data	Derived using prospect. Data	Validated using primary data	Validated using prospect. Data	Multi-variate modelling	Follow-up	Notes
	patients with suspicious findings on standard cervical spine views, Flexion Extension views are useful in ruling out ligamentous instability	CHILDREN under 16 Single USA children's trauma hospital Non-consecutive	Final diagnosis given by radiologist blinded to patients results, with all images available to him											Note this study includes cervical strain, indeterminate plain radiography, cervical disc disease and SCIWORA in its group of positive final diagnoses. Only 3 fractures were found in this study.
Tehrandaeh et al (1994) ⁵⁰⁹ Level 3 evidence	Retrospective cohort study Patients who do not have their C7-T1 spine adequately	N=100 Patients after blunt injury and non-visualisat	Cervical spine injury on CT Gold standard	N/A	N/A	N/A	3 out of 100 had cervical injury	Yes	No	No	No	No	Article states that records were reviewed for	These 100 patients are 2.5% of patients who underwent plain radiography in this

National Clinical Guideline Centre, 2014.

Names and evidence level	Rule description	Participants	Outcome measures	Specificity	Sensitivity	Investigation ordering rate	Prevalence	Derived using primary data	Derived using prospect. Data	Validated using primary data	Validated using prospect. Data	Multi-variate modelling	Follow-up	Notes
Non-consecutive study	cleared on plain radiography may safely undergo clearance by CT scanning	<p>ion of C7-T1 on plain radiography who had a CT for this reason.</p> <p>Average age 36 years unclear as to whether any children included</p> <p>Single USA hospital</p> <p>Non-consecut</p>	<p>CT scan performed in 100%</p> <p>Follow up performed</p>										<p>any complaints referable to the spine, and the patients were contacted where possible</p>	<p>department in the study period.</p> <p>Follow up rate not reported</p> <p>In a very small subset of patients the C7-T1 can be followed up safely</p>

Names and evidence level	Rule description	Participants	Outcome measures	Specificity	Sensitivity	Investigation ordering rate	Prevalence	Derived using primary data	Derived using prospect. Data	Validated using primary data	Validated using prospect. Data	Multi-variate modelling	Follow-up	Notes
West et al (1997) ⁵³²	Retrospective matched case control study	ive N=92 Patients with clinically proven cervical fractures	Cervical injury diagnosed on 1 and then 3 view radiography interpreted by 20 radiographers of a variety of grades Gold standard for fracture was discharge diagnosis	81.9% with 1 view 79.7% with 3 views	81% with 1 view, 83.3% with 3 views	100%	100%	Yes	No	No	No	No	No	This is a study that assesses 20 radiologists' ability to diagnose a known fracture on either 1 or 3 view radiographs.
Level 4 evidence	Three-view radiography allows most readers to detect a few more fractures than a single view radiograph.													
Case-control study														

Names and evidence level	Rule description	Participants	Outcome measures	Specificity	Sensitivity	Investigation ordering rate	Prevalence	Derived using primary data	Derived using prospect. Data	Validated using primary data	Validated using prospect. Data	Multi-variate modelling	Follow-up	Notes
			s of cervical fracture											
Woods et al (1998) ⁵³⁷ Level 4 evidence Non-consecutive study with inadequate gold standard	Retrospective study of paediatric flexion extension views There were no complications from the use of flexion-Extension views, and they were a useful addition to plain radiography.	N=133 All alert Symptoms or no symptoms Children 0-16 Single USA centre Non Consecutive	Fracture on 3 view plain radiography or Flexion Extension views Gold standard : negative radiology and discharged	N/A	N/A	100%	0% fractures, 5% abnormal F-E views but all discharged home. 2 cases of SCIWORA	Yes	No	No	No	No	No	No positive cases found. This study has selective cases and is underpowered

O.7.12 Treatment of the intubated or severely injured patient

Table 111: Studies from original 2003 guideline

Names and evidence level	Rule description	Participants	Outcome measures	Specificity	Sensitivity	Investigation ordering rate	Prevalence	Derived using primary data	Derived using prospect. Data	Validated using primary data	Validated using prospect. Data	Multi-variate modelling	Follow-up	Notes
Ajani et al (2002) ¹² Level 1 evidence Well conducted validation cohort study – with the assumption that follow up was adequate	Prospective observational cohort study All patients suffering major trauma should have 3-view plain radiography, swimmers views if further evaluation of C7-T1 is needed and CT and /or MRI for abnormal areas. Flexion/Extension views to	N=100 Patients admitted to the ICU after major trauma. Symptomatic and asymptomatic Adults over 15 years old Single Australia	Cervical spine injury Gold standard : Abnormality after conduction of protocol. Presumably follow up also performed	0%	100%	79 normal plain radiographs 48 had passive flexion/extension views 12 had active flexion/extension views 1 CT scan	6 out of 100 (6%) had unstable injuries	Unclear as to how protocol was devised, probably after literature review	Unclear	Yes	Yes	No	Follow up not described but presumably performed in this ICU unit	91 patients survived to complete evaluation. This protocol was assessed after it had been implemented for several years in this institution. Philadelphia collars remained in place for mean 65 hours (range 1.5 to 240 hours)

National Clinical Guideline Centre, 2014.

Names and evidence level	Rule description	Participants	Outcome measures	Specificity	Sensitivity	Investigation ordering rate	Prevalence	Derived using primary data	Derived using prospect. Data	Validated using primary data	Validated using prospect. Data	Multi-variate modelling	Follow-up	Notes
	exclude cervical spine instability due to soft tissue trauma were performed if clinical examination was not possible.	n Intensive care unit. Consecutive				performed								
Albrecht et al (2001) ¹³ Level 2 evidence Well conducted cohort study	Retrospective review of patients receiving MRI scanning in ICU MRI provides a safe and risk free method for clearing the cervical spine in not fully conscious	N=150 Not fully conscious patients only Adults only Single USA trauma	Fracture on radiography Gold standard : Fracture on MRI scanning or follow up	N/A	N/A	100%	41/150 (27%) Only those who had no fracture on plain radiography had MRI, none	Yes	No	No	No	No	Notes were reviewed for follow up	Of the 108 patients with negative plain radiography who went on to have MRI, only 21 had a normal MRI allowing removal of the collar.

Names and evidence level	Rule description	Participants	Outcome measures	Specificity	Sensitivity	Investigation ordering rate	Prevalence	Derived using primary data	Derived using prospect. Data	Validated using primary data	Validated using prospect. Data	Multi-variate modelling	Follow-up	Notes
	patients in ICU	centre Consecutive					of these had a fracture							
Berne et al (1999) ⁴¹ Level 2 evidence Small but well conducted study	Prospective observational cohort study In patients who cannot have their C-spine evaluated due to the following: Head injury, shock, alcohol, illicit drugs, or sedated/paralysed for ventilation, who are admitted to the ICU and	N=58 Patients admitted to ICU, C-spine unable to evaluate clinically Adults over 17 years old Single level 1 trauma centre	Cervical spine injury Gold standard All patients had 3-view C-spine radiography and Helical CT	Plain radiograph: specificity 100% CT specificity: 100%	Plain radiographs: sensitivity: 60% CT sensitivity: 90%	100% CT and plain radiographs recommended	20 of 58 (34%)	Yes	Yes	No	No	No	Not described	Small study Of 67 eligible for the study, 9 did not get the radiographic studies as stated in the protocol

Names and evidence level	Rule description	Participants	Outcome measures	Specificity	Sensitivity	Investigation ordering rate	Prevalence	Derived using primary data	Derived using prospect. Data	Validated using primary data	Validated using prospect. Data	Multi-variate modelling	Follow-up	Notes
	are undergoing CT of other body systems: Helical CT scanning is superior to plain radiography in clearing the cervical spine.	Consecutive												
Brooks et al (2001) ⁶⁵ Level 2 evidence Well conducted but small	Retrospective cohort validation study. All patients remaining unconscious or clinically inaccessible for >24 hours	N=78 patients undergoing dynamic screening. Unconscious or intubate	Cervical injury Gold standard: Results of all imaging	Not applicable	Not applicable	Not applicable	5 of 78 (6%)	Not stated	Not stated	Yes	Yes	No	Patients seem to have been followed up to discharge or post mortem although 100% post	Plain radiographs would have missed 30% of fractures

Names and evidence level	Rule description	Participants	Outcome measures	Specificity	Sensitivity	Investigation ordering rate	Prevalence	Derived using primary data	Derived using prospect. Data	Validated using primary data	Validated using prospect. Data	Multi-variate modelling	Follow-up	Notes
study.	<p>the following should be performed:</p> <p>AP and Lateral films of the cervical, thoracic and lumbar spine</p> <p>CT scan of C1/C2 no peg views obtained. Dynamic flexion and extension views of the cervical spine performed under image intensification by a trauma Consultant.</p>	<p>d trauma patients.</p> <p>Age range 11 to 90 years old</p> <p>Single UK hospital</p> <p>Consecutive</p>	<p>or of neck examination on recovery or post mortem</p>										<p>mortem or follow up is not confirmed</p>	

Names and evidence level	Rule description	Participants	Outcome measures	Specificity	Sensitivity	Investigation ordering rate	Prevalence	Derived using primary data	Derived using prospect. Data	Validated using primary data	Validated using prospect. Data	Multi-variate modelling	Follow-up	Notes
Cohn et al (1991) ⁸⁴ Level 3 evidence Non-consistent gold standard	Prospective cohort study Lateral C-spine films are falsely reassuring and methods for intubation should treat the spine as unstable until 3 view clearance.	N=60 Intubated or multiply injured patients Adults and children Single USA trauma centre Consecutive	Fracture on radiography Gold standard : all patients had 3 view plain radiography and also other investigations at the clinician's discretion	N/A	N/A	N/A	7/60 Lateral C-spine films missed 3 of these injuries	Yes	Yes	No	No	No	NO	
D'Alise et al	Prospective observational cohort study	N=121	Cervical injury on MRI	N/A	N/A	N/A	31 of 121 (25%)	Yes	Yes	No	No	No	None reported	No follow up was reported so that there

National Clinical Guideline Centre, 2014.

Names and evidence level	Rule description	Participants	Outcome measures	Specificity	Sensitivity	Investigation ordering rate	Prevalence	Derived using primary data	Derived using prospect. Data	Validated using primary data	Validated using prospect. Data	Multi-variate modelling	Follow-up	Notes
(1999) ⁹⁴ Level 3 evidence Non consecutive study	Using MR imaging in patients not fully conscious or intubated patients allows clearance of the cervical spine.	Patients all intubated due to head or multi-system injury Adults and children Single USA trauma centre Non consecutive	scanning Gold standard : None – MRI was used in 100% of cases and selected suspicious cases also had a CT. No follow up				had significant injuries not seen on plain radiography, 8 required surgery							was no attempt to verify that the MRI scan did not miss any injuries
Davies et al (1995) ⁹⁸	Prospective cohort study of dynamic fluoroscopy	N=116 Patients not fully	Fracture on fluoroscopy or 3	N/A	N/A	100%	No missed clinically	Yes	Yes	No	No	NO	Yes	Decubitus ulcers were common and occurred in

Names and evidence level	Rule description	Participants	Outcome measures	Specificity	Sensitivity	Investigation ordering rate	Prevalence	Derived using primary data	Derived using prospect. Data	Validated using primary data	Validated using prospect. Data	Multi-variate modelling	Follow-up	Notes
Level 2 evidence Well conducted cohort study	in patients that are not fully conscious. Dynamic fluoroscopy can safely clear the C-spine in not fully conscious patients.	conscious, GCS <13 Adults only Single USA trauma centre Consecutive	view radiography Gold standard : Fracture on any imaging or on follow up				significant fractures							44%of patients, due to the collar remaining in place for long periods.
Davis et al (2001) ⁹⁷ Level 1 evidence Well conducted	Retrospective cohort study The cervical spine may be cleared after a normal C-spine plain series and CT scanning according to	N=301 GCS <13 for more than 48 hours. Assumed to be adults	Cervical injury as determined by fluoroscopy. Gold standard : All	Not assessable	100% sensitivity of EAST guidelines	Not investigated	2 of 301 patients had cervical injury diagnosed on fluoroscopy. (0.7%)	EAST guidelines	EAST guidelines	Yes	No	No	Neurological examination daily to discharge, post-mortem, and review of all	Fluoroscopy was performed a mean 6 days after admission (SD +/- 0.2 days) This study provides

Names and evidence level	Rule description	Participants	Outcome measures	Specificity	Sensitivity	Investigation ordering rate	Prevalence	Derived using primary data	Derived using prospect. Data	Validated using primary data	Validated using prospect. Data	Multi-variate modelling	Follow-up	Notes
validation cohort study	EAST guidelines. Fluoroscopy is of little use and may be dangerous	only as mean age 34. Single USA trauma centre. Consecutive	patients received 5 view plain radiographs, CT scanning and follow up				– both treated conservatively. Also 1 false positive and 1 false negative.						notes 60 to 90 days after discharge.	evidence for the validation of the 1998 EAST protocol in the subset of moderate and severe head injuries.
Gerrelts et al ¹⁶¹ (1991) Level 4 evidence Non-independent Gold standard (patients	Retrospective observational cohort study In patients after severe blunt trauma plain radiography alone is not adequate to	N=1331 Severe blunt injury patients all levels of alertness Symptomatic	Cervical injury on 5 view radiography Delayed Diagnosis of cervical injury after	Not reported	Sensitivity of plain radiography 85.2% in the group that had fractures	No rule	61 out of 1331 (4.6%) 5 had delayed recognition of injury	Yes	No	No	No	No	None described	Cervical spine injury was missed in 5 patients by plain radiography. All were due to incomplete or inadequate plain radiography

Names and evidence level	Rule description	Participants	Outcome measures	Specificity	Sensitivity	Investigation ordering rate	Prevalence	Derived using primary data	Derived using prospect. Data	Validated using primary data	Validated using prospect. Data	Multi-variate modelling	Follow-up	Notes
received CT on basis of plain radiography and clinical opinion)	exclude spinal injury.	Adults over 17 years old Single USA level 1 trauma centre. Consecutive	negative complete C-spine series. Gold standard : All patients received 5 film plain views, and selective CT and MRI scans done. Final results diagnosed by the author – radiologist											

Names and evidence level	Rule description	Participants	Outcome measures	Specificity	Sensitivity	Investigation ordering rate	Prevalence	Derived using primary data	Derived using prospect. Data	Validated using primary data	Validated using prospect. Data	Multi-variate modelling	Follow-up	Notes
			st.											
Hindman et al ²⁰⁴ (1998) Level 3 evidence	This paper is a review of Cervical Clearance in patients not fully conscious, advocating MRI followed by Dynamic Fluoroscopy													
Holly et al (2002) ²¹⁵ Level 3 evidence Non-consecutive study	Retrospective cohort study Patients with moderate to severe head injury are at increased risk of cervical fracture and should have full plain radiography with CT and Flexion/extension views and necessary.	N=447 Patients with moderate or severe head injuries. GCS 3-12 or >12 with abnormal head CT Symptomatic patients	Cervical spine injury GCS Glasgow outcome score Gold standard : ICD coding of	Not done	Not done	Not done	24 of 447 patients (5.4%)	Yes	No	No	No	No	Results of GOS reported for those with cervical fracture but follow up not described	Study is of limited relevance to us

Names and evidence level	Rule description	Participants	Outcome measures	Specificity	Sensitivity	Investigation ordering rate	Prevalence	Derived using primary data	Derived using prospect. Data	Validated using primary data	Validated using prospect. Data	Multi-variate modelling	Follow-up	Notes
		2 level 1 trauma centres Non-consecutive	spinal injury											
Jelly et al ²³¹ (2000) Level 3 evidence Non-consecutive study	Prospective observational cohort study Routine CT of intubated and ventilated patients after blunt trauma can detect occult fractures of the cervico-thoracic junction, missed by	N=73 Intubated and ventilated at the site of injury Adults and children 2-94 years Single UK	Cervical spine injury on 3 view radiography (lateral and 2 oblique views) And spiral CT scanning of C6 to T2	N/A	N/A	N/A	20 out of 73 (27%) 12 were of cervico-thoracic junction. 5 seen by plain radiogr	Yes	Yes	No	No	No	No	Only 73 of 204 trauma patients attending their unit were studied, as only 73 had both CT and plain radiography. Only 25 of 73 radiographs visualised C7-T1 space. Most of the

National Clinical Guideline Centre, 2014.

Names and evidence level	Rule description	Participants	Outcome measures	Specificity	Sensitivity	Investigation ordering rate	Prevalence	Derived using primary data	Derived using prospect. Data	Validated using primary data	Validated using prospect. Data	Multi-variate modelling	Follow-up	Notes
	plain radiography.	hospital Non- Consecutive					aphy.							fractures detected were not significant.
Katzberg et al (1999) ²⁴¹ Level 3 evidence Non consecutive study	Prospective cohort study MRI scans can more accurately detect a wide range of neck injuries compared to conventional CT	N=199 All levels of alertness Symptoms not stated Adults and children over 9 years Non consecutive	Cervical injury Gold standard : CT and MRI in all patients	N/A	N/A	N/A	58 out of 199 patients (34%)	Yes	Yes	No	No	No	Not stated	No decision rule given. This is a study looking at the ability of MR scan to detect additional images to CT scanning

Names and evidence level	Rule description	Participants	Outcome measures	Specificity	Sensitivity	Investigation ordering rate	Prevalence	Derived using primary data	Derived using prospect. Data	Validated using primary data	Validated using prospect. Data	Multi-variate modelling	Follow-up	Notes
Kirshenbaum et al ²⁵¹ (1990) Level 4 evidence Inadequate reference standards	Retrospective case series Routine CT of the upper cervical vertebrae should be routinely performed in all patients with significant head injury.	N=53 Patients after significant head injury No symptomatic status reported Age not stated Single USA trauma centre Non-consecutive	Cervical injury on 3-view plain radiography or CT. Gold standard : Cervical CT scanning No follow up	N/A	N/A	N/A	7 out of 53 patients had cervical injury detected on CT that were not visible on plain radiography	Yes	No	No	No	No	No follow up described	3 of these positive cases were an individual case series that stimulated the authors to conduct a study on the next 50 patients having Head CT after head injury with a severity determined by the admitting physician. Cervical CT is the test diagnostic tool but also the gold

National Clinical Guideline Centre, 2014.

Names and evidence level	Rule description	Participants	Outcome measures	Specificity	Sensitivity	Investigation ordering rate	Prevalence	Derived using primary data	Derived using prospect. Data	Validated using primary data	Validated using prospect. Data	Multi-variate modelling	Follow-up	Notes
														standard, as no follow up was done to exclude missed injury by CT
Malomo et al ²⁸⁹ (1995) Level 4 evidence Inconsistent reference standards	Retrospective Cohort study Cervical Radiography should be performed on all patients after head injury associated with loss of consciousness who are above 10 years old.	N=457 Patients following Head injury with at least Loss of consciousness All age groups Single Nigerian University Hospital	Cervical spine injury on 5-view radiography. Gold standard 5 view radiography. No follow up no other imaging	N/A	N/A	N/A	76 out of 457 (17%)	Yes	No	No	No	No	None described	31 of the 76 spine injuries were unexpected clinically. No follow up to verify the absence of injury in these patients

Names and evidence level	Rule description	Participants	Outcome measures	Specificity	Sensitivity	Investigation ordering rate	Prevalence	Derived using primary data	Derived using prospect. Data	Validated using primary data	Validated using prospect. Data	Multi-variate modelling	Follow-up	Notes
		Consecutive												
Nunez et al (1996) ³⁵⁹ Level 4 evidence Small case series	Retrospective case series Helical CT can demonstrate cervical injuries not shown by plain radiography in polytrauma victims	N=88 Patients who had a cervical fracture, plain radiography and helical CT GCS and symptoms not reported Age not reported Single USA trauma	Cervical injury on 3-view radiography and on helical CT Gold standard : Images all independently reviewed and 4 month follow up also	N/A	N/A	N/A	32 out of 88 (36%) Had injuries missed by plain radiography	Yes	No	NO	NO	No	Clinical follow up to 4 months	Small case series

Names and evidence level	Rule description	Participants	Outcome measures	Specificity	Sensitivity	Investigation ordering rate	Prevalence	Derived using primary data	Derived using prospect. Data	Validated using primary data	Validated using prospect. Data	Multi-variate modelling	Follow-up	Notes
		centre Non consecutive - Selected at random.	available											
Schenarts et al (2001) ⁴⁴³ Level 1 evidence Well conducted validation cohort study	Prospective cohort study Rule: The EAST guidelines identified all patients who had cervical injury	N= 1356 Altered mental status requiring CT scan of 2 or more body systems Age over 14 years old	Cervical injury Gold standard : All patients received 5 view plain radiography and CT scanning .	Not assessable	100% sensitivity of EAST guidelines	Not investigated	70 out of 1356 (5.2%) 32 of these were missed on plain radiography 3 were missed by CT	EAST guidelines	EAST guidelines	Yes	Yes	No	No readmissions or lawsuits have been filed in the study population	Validates the EAST guidelines in patients with altered mental status The clinical history seems to have been gained from the hospital records and trauma registry and not

Names and evidence level	Rule description	Participants	Outcome measures	Specificity	Sensitivity	Investigation ordering rate	Prevalence	Derived using primary data	Derived using prospect. Data	Validated using primary data	Validated using prospect. Data	Multi-variate modelling	Follow-up	Notes
		Single USA trauma centre Consecutive	Assessed by 2 radiologists.				but seen on plain films							prospectively collected on admission.
Sees et al ⁴⁵⁴ (1998) Level 4 evidence Small retrospective non consecutive study	Retrospective case series Fluoroscopy in patients not fully conscious is a safe procedure and easy to perform. In addition it may give reassurance that no cervical injury is present	N=20 Not fully conscious trauma patients admitted to an intensive care unit who had fluoroscopy Age 40 +/- 3.6 years	Cervical spine injury Gold standard : Patients had a range of CT, and clinical examinations, all had 3 view radiogra	N/A	N/A	N/A	1 patient had a cervical injury	Yes	No	No	No	No	No	Very small study

Names and evidence level	Rule description	Participants	Outcome measures	Specificity	Sensitivity	Investigation ordering rate	Prevalence	Derived using primary data	Derived using prospect. Data	Validated using primary data	Validated using prospect. Data	Multi-variate modelling	Follow-up	Notes
		Single USA army medical centre Non consecutive	phy											

O.7.13 The Paediatric patient

Table 112: Studies from original 2003 guideline

Names and evidence level	Rule description	Participants	Outcome measures	Specificity	Sensitivity	Investigation ordering rate	Prevalence	Derived using primary data	Derived using prospect. Data	Validated using primary data	Validated using prospect. Data	Multi-variate modelling	Follow-up	Notes
Dietrich et al (1991) ¹⁰⁹	Retrospective case series	N=50 patients with cervical	Cervical spine injury as docume	Not applica ble	Not applica ble	Not applica ble	100%	Yes	No	No	No	No	No	83% of children had no neurology on initial

National Clinical Guideline Centre, 2014.

Names and evidence level	Rule description	Participants	Outcome measures	Specificity	Sensitivity	Investigation ordering rate	Prevalence	Derived using primary data	Derived using prospect. Data	Validated using primary data	Validated using prospect. Data	Multi-variate modelling	Follow-up	Notes
Level 4 evidence Case series	All children with neck pain or tenderness need full radiographic evaluation of their cervical spine	fracture All levels of alertness Symptomatic and asymptomatic Children, aged 2 to 19 years old Single USA children's Hospital Non-consecut	nted in hospital medical records Gold Standard None											physical examination Lateral Cervical spine radiograph identified 98% of children

Names and evidence level	Rule description	Participants	Outcome measures	Specificity	Sensitivity	Investigation ordering rate	Prevalence	Derived using primary data	Derived using prospect. Data	Validated using primary data	Validated using prospect. Data	Multi-variate modelling	Follow-up	Notes
Dwek et al (2000) ¹²² Level 4 evidence No gold standard applied	Retrospective cohort study In children with a history of trauma and normal findings on cervical spine radiographs, additional flexion-extension radiographs are of questionable value.	ive. N=247 patients who had plain radiography and flexion / extension views All levels of alertness – 775 normal GCS Symptomatic and asymptomatic CHILDRE	Cervical injury on 3 view radiography (no peg view in under 4 year olds) Or on F/E views Gold standard : Abnormal results of radiography or	N/A	N/A	N/A	23 or 247 (9%) All of these found on plain radiographs.	Yes	No	No	No	No	The notes were reviewed of each admission to look of any missed injury. No outpatient follow up done	4 patients with questionable findings on plain radiography had their spine cleared on flexion / Extension views. Other than this no useful information was gained from F/E views. There was no gold standard applied to the Flexion/Extension views or to the plain

Names and evidence level	Rule description	Participants	Outcome measures	Specificity	Sensitivity	Investigation ordering rate	Prevalence	Derived using primary data	Derived using prospect. Data	Validated using primary data	Validated using prospect. Data	Multi-variate modelling	Follow-up	Notes
		N ONLY, under 18years old Single USA trauma centre Non-consecutive	abnormality recorded in the notes while admitted											views so the true number of false negatives is not known unless progress until discharge is an acceptable gold standard.
Laham et al (1994) ²⁵⁹ Level 3 evidence Retrospective study, with no universal	Cervical spine X-rays are only indicated in high risk paediatric patients with a head injury who either complains of neck pain or cannot voice such	N=268 Children with significant head injury defined as one with clinical and	Cervical injury on 3 view radiography Gold standard : 3-view	52%	100%	48%	10 out of 268 (3.7%)	Yes	No	No	No	No	No	The entry criteria of: significant head injury needing admission was made at the discretion of the PICU assessment officer.

Names and evidence level	Rule description	Participants	Outcome measures	Specificity	Sensitivity	Investigation ordering rate	Prevalence	Derived using primary data	Derived using prospect. Data	Validated using primary data	Validated using prospect. Data	Multi-variate modelling	Follow-up	Notes
ly applied gold standard .	complaints because of significant head injury or preverbal age.	radiographic evidence on CT. Symptomatic and asymptomatic Children 0-19 years old Single USA children's hospital intensive care unit. Consecut	radiography only (only 80% of children received this) No follow up											GCS was not consistently recorded in these children 215 children had cervical radiographs (80%)

Names and evidence level	Rule description	Participants	Outcome measures	Specificity	Sensitivity	Investigation ordering rate	Prevalence	Derived using primary data	Derived using prospect. Data	Validated using primary data	Validated using prospect. Data	Multi-variate modelling	Follow-up	Notes
		ive patient that were admitted to the PICU.												
Schwartz et al (1997) ⁴⁵¹ Level 4 evidence Case series	Retrospective case series Radiographic investigation is not necessary in asymptomatic children under 6 after a short fall.	N=did not state how many patient's charts were reviewed – total of 44 centre-years of notes were searched All levels of alertness	ICD-9 codes for cervical vertebral injury, cervical cord injuries and cervical vertebra and cord injury were considered as positive	Not appropriate for this type of study	Not appropriate for this type of study	Not appropriate for this type of study	8 children were found with cervical spine injury after a fall from a low height	Yes	No	NO	No	No	No	This is a large case series 33 children with cervical spine injury were excluded from the study as they did not meet the criteria for mechanism of injury This study is of little relevance to

Names and evidence level	Rule description	Participants	Outcome measures	Specificity	Sensitivity	Investigation ordering rate	Prevalence	Derived using primary data	Derived using prospect. Data	Validated using primary data	Validated using prospect. Data	Multi-variate modelling	Follow-up	Notes
		<p>Symptomatic and asymptomatic Children younger than 6 years old</p> <p>4 USA hospitals</p> <p>Non-consecutive – all patients with injury were looked for but only positive</p>	<p>Gold Standard :</p> <p>No gold standard applied to exclude injury.</p>											this review.

Names and evidence level	Rule description	Participants	Outcome measures	Specificity	Sensitivity	Investigation ordering rate	Prevalence	Derived using primary data	Derived using prospect. Data	Validated using primary data	Validated using prospect. Data	Multi-variate modelling	Follow-up	Notes
		cases were studied												

O.7.14 Clinical prediction rule for selecting patients that have sustained damage to the cervical spine for the imaging technique selected

Table 113: Bandiera 2003

Update studies 2007

Study details	Patients	Diagnostic Tool	Outcome measures	Effect size	Comments
Bandiera 2003 ²⁵ Study design: Prospective cohort study Evidence level: Diagnostic study Level-1+ Duration of follow-up: 14 days follow-up by structured telephone interview (patients)	Patient group: All ambulatory or immobilised adult patients who were (1) haemodynamically stable (2) alert (GCS of 15), (3) and had either neck pain from any mechanism of injury or no neck pain but some visible injury above the clavicles, had not been ambulatory, and had experienced a dangerous mechanism of injury. Patients were selected from ten Canadian urban teaching and community emergency departments All patients	Assessment tool under investigation: Physicians were asked to prospectively estimate the probability that the patient would have a clinically important c-spine injury by opting for one of following: 0%, 1%, 2%, 3%, 4%, 5%, 10%, 20%, 30%, 40%, 50%, 75%, 100%. Physicians were asked to base this estimate on their judgement after considering facts obtained in patients history and physical examination alone, without assistance of decision rule and before radiographs were	CLINICALLY IMPORTANT C-SPINE INJURY Physicians judgement (n=6265) (To predict at least 0% probability of clinically important c-spine injury). Sensitivity Specificity Prevalence CLINICALLY IMPORTANT C-SPINE INJURY Comparison to Canadian C-spine rule (n=6265) Sensitivity Specificity Prevalence	92.2% (95% CI 82% to 96%) 53.9% (95% CI 82% to 96%) 64 (1.0%) 100% (95% CI 94% to 100%) 44.0% (95% CI 43% to 45%) 64 (1.0%)	Funding: Supported by peer-reviewed grants from the MRC of Canada and Ontario Ministry of Health Emergency Health Services Committee. Limitations: Not all patients received imaging and were instead followed up by 14 day telephone interview. Additional outcomes: The areas under the ROC curve for predicting cervical spine injury were physician judgement 0.85 (95% CI 0.80 to 0.89) and Canadian C-spine rule 0.91 (95% CI 0.89 to 0.92; p<0.05).

Study details	Patients	Diagnostic Tool	Outcome measures	Effect size	Comments
that did not receive imaging).	N: 6265 Age (mean): 36.6 (SD 16) M/F: 3177/3088 Clinically important C-spine injury = 64/6265 (1%) Clinically unimportant C-spine injury = 16 (0.3%)	reviewed. Imaging: Plain radiography (with or without flexion and extension views and CT imaging) as requested by judgement of treating physician.			In 89 cases the interobserver k for predicting a 0% probability of important c-spine injury according to physicians judgment was 0.46 (95% CI 0.28 – 0.65) Notes: This study was undertaken as part of phase I of the Canadian C-Spine Study.

Table 114: Stiell 2003

Study details	Patients	Diagnostic Tool	Outcome measures	Effect size	Comments
Stiell 2003 ⁴⁹² Study design: Prospective Cohort Study Evidence level: Diagnostic study level-1+	Patient group: consecutive adult patients with acute trauma to the head or neck who were both in stable condition and alert and who had either neck pain or no neck pain but met all of the following criteria: they had visible injury above the clavicles, were non ambulatory, and who had a dangerous mechanism of injury. Additional	Assessment tool under investigation: Canadian C-Spine Rule (CCR) compared to NEXUS Low Risk Criteria (NLC) 845 patients were classified as indeterminate	Clinically important c-spine injury: NEXUS (not including 845 indeterminate patients) Sensitivity Specificity p-value Positive predictive value Negative predictive value Injuries correctly identified Outcome: CCR (not including 845 indeterminate patients) Sensitivity	(n=7438) 90.7% (95% CI, 85-94) 36.8% (95% CI, 36-38) <0.001 NR 99.4% 147/162 (n=7438) 99.4% (95% CI, 96-100)	Funding: Support by peer-reviewed grants from Canadian Institutes of Health research and Ontario Ministry of Health Emergency Health Services Committee. Limitations: Classification of unimportant clinical injuries. Additional outcomes: 45 cases of clinically unimportant injuries, the

Study details	Patients	Diagnostic Tool	Outcome measures	Effect size	Comments
Duration of follow-up: 14 day follow-up of patients who did not have radiography.	<p>eligibility criteria were a GCS of 15, normal vital signs and injury within the previous 48 hours.</p> <p>Location: Emergency departments of nine Canadian tertiary care hospitals.</p> <p>All patients N: 8283 N C-Spine Injury: 169 (2%) Age (mean): 37.6±16 M/F: 4328/3955</p> <p>3603 eligible patients were not enrolled by physicians and 635 had data forms but no outcome assessments (these subjects did not undergo radiography).</p>	<p>and omitted from primary analysis. These patients were not tested on range of motion which is required for prediction by Canadian C-Spine rule.</p> <p>Reference standard: Plain radiography as requested by judgement of the treating physician.</p>	<p>Specificity</p> <p>p-value</p> <p>Positive predictive value</p> <p>Negative predictive value</p> <p>Injuries correctly identified</p>	<p>45.1% (95% CI, 44-46)</p> <p><0.001</p> <p>NR</p> <p>100%</p> <p>161/162</p>	<p>sensitivity of the CCR was 97.8% compared to 80.% for the NLC.</p> <p>The kappa value for interobserver agreement in the interpretation of the overall rules in 142 cases was 0.63 (95% CI, 0.49-0.77) for the CCR and 0.47 (95% CI, 0.28-0.65) for NEXUS.</p> <p>Potential effect on radiography was evaluated by estimating the proportion of patients who would require radiography according to the rules. (CCR: 55.9% and NEXUS: 66.6% (excluding indeterminates)</p> <p>Length of stay and clinical acceptability rated.</p>
			<p>Outcome: NEXUS (secondary analysis including indeterminate patients):</p> <p>Sensitivity</p> <p>Specificity</p>	<p>(n=8283)</p> <p>90.5%(95% CI, 85-94)</p> <p>33.0%(95% CI, 33-35)</p>	
			<p>Outcome: CCR (secondary analysis including indeterminate patients): when the CCR was assumed to be positive for all indeterminate cases:</p> <p>Sensitivity</p> <p>Specificity</p> <p>p-value</p>	<p>(n=8283)</p> <p>99.4%(95%CI,96-100)</p> <p>40.4%(95% CI, 39-42)</p> <p><0.001 for comparisons</p>	
			<p>Outcome: CCR (secondary analysis including indeterminate patients): when the CCR was assumed to be negative for all indeterminate cases:</p> <p>Sensitivity</p> <p>Specificity</p>	<p>(n=8283)</p> <p>95.3%(95% CI, 91-97); P=0.09</p> <p>50.7(95% CI, 50-52); P=0.001</p>	

O.7.15 Data extraction for papers describing rules for diagnosis of long term disability

Table 115: Studies from original 2003 guideline

Names and evidence level	Rule description	Participants	Outcome measures	Specificity	Sensitivity	Investigation ordering rate	Prevalence	Derived using primary data	Derived using prospect. Data	Validated using primary data	Validated using prospect. Data	Multi-variate modelling	Follow-up	Notes
Asikainen et al ¹⁸ 1997 Level 3 evidence	Prospective cohort study GCS correlated with all outcomes Length of come, and duration of post-traumatic amnesia correlated with GOS.	N=508 All GCS scores Adults and children (46% under 16 years) Patients attending Finnish rehabilitation clinic	GOS Post injury occupational outcome	N/A	N/A	N/A	Only 50% of patients with an initial GCS 13-15 had a good recovery and up to 20% were still unable to work	Yes	Yes	No	No	No	N/A	1500 patients were seen in this period. Only the 508 that were followed up for 5 years were included in the study. This study is therefore

National Clinical Guideline Centre, 2014.

Names and evidence level	Rule description	Participants	Outcome measures	Specificity	Sensitivity	Investigation ordering rate	Prevalence	Derived using primary data	Derived using prospect. Data	Validated using primary data	Validated using prospect. Data	Multi-variate modelling	Follow-up	Notes
		Consecutive												actually quite a highly selected group of head injured patients
Barth et al ³⁰ 1983 Level 3 evidence This paper is a subset of the Rimel cohort describe	Prospective cohort study Age, education, rapid visuomotor problem solving and memory were predictive of cognitive function after Minor head injury	N=73 GCS 13-15, LOC<20 mins <48hrs admission Adults over 15 years old Single	Multiple Neuropsychological evaluation tests, 3 months after injury	N/A	N/A	N/A	Patients with minor head injury had low scores on a range of neuropsychometric tests.	Yes	Yes	No	No	Yes	Yes	With the Rimel paper of 1981 these papers were the first indications that patients with a minor head injury were

Names and evidence level	Rule description	Participants	Outcome measures	Specificity	Sensitivity	Investigation ordering rate	Prevalence	Derived using primary data	Derived using prospect. Data	Validated using primary data	Validated using prospect. Data	Multi-variate modelling	Follow-up	Notes
d earlier)	Post traumatic amnesia and period of loss of consciousness was not predictive	USA hospital Random sample from a total sample of 1248 head injured pts.												<p>suffering long term disabilities</p> <p>This paper unfortunately has no control group, is a selected sample. The clinical relevance of many of the tests quoted is also not made clear.</p> <p>It has also been suggested</p>

Names and evidence level	Rule description	Participants	Outcome measures	Specificity	Sensitivity	Investigation ordering rate	Prevalence	Derived using primary data	Derived using prospect. Data	Validated using primary data	Validated using prospect. Data	Multi-variate modelling	Follow-up	Notes
														that 3 months is perhaps too early to assess long term disability
Bazarian et al ³⁶ 1999 Level 3 evidence	Prospective case control study 71 Minor Head injured patients (LOC<10 mins, GCS 15) with 60 orthopaedic patients as controls Predictors were: Female gender,	N= 131 Adults over 16 GCS 15 only Single USA hospital Convenience sample	DSMIV criteria for post-concussive syndrome	N/A	N/A	N/A	Incidence of post concussive syndrome at 1 month was 58%, 3 months 43% and at 6 months 25%.	Yes	Yes	NO	No	Yes	Telephone follow up at 1, 3 and 6 months	

Names and evidence level	Rule description	Participants	Outcome measures	Specificity	Sensitivity	Investigation ordering rate	Prevalence	Derived using primary data	Derived using prospect. Data	Validated using primary data	Validated using prospect. Data	Multi-variate modelling	Follow-up	Notes
	presence of both antero- and retro-grade amnesia, digit span forward scores, Hopkins verbal learning A scores – at 1 month No variables predicted concussion at 6 months													
Bazarian et al ³⁴ 2000 Level 3	Prospective observational study with orthopaedic control group	N=71 cases and 41 controls Patients all GCS	Outcome measure was whether patient attended	N/A	N/A	N/A	44% of patients attended for follow up 1-month post injury. 75% of non follow up group had no	Yes	Yes	No	No	Yes	Part of study outcome	Provides some factors that predict lack of follow up.

National Clinical Guideline Centre, 2014.

Names and evidence level	Rule description	Participants	Outcome measures	Specificity	Sensitivity	Investigation ordering rate	Prevalence	Derived using primary data	Derived using prospect. Data	Validated using primary data	Validated using prospect. Data	Multi-variate modelling	Follow-up	Notes
evidence	Factors that predicted attendance for follow up were: Head CT in ED, associated laceration, female gender, and absence of African-American race.	15, no skull fracture, LOC<10 mins Adults over 16 years old Single USA hospital Convenience sample	d follow up.				symptoms as the reason for not attending but only 38% of the follow up group stated that the reason they attended for follow up was that they had symptoms.							But presence of follow up is not a good predictor of disability – as found in this study
Bazarian et al ³⁵ 2001 Level 2	Prospective observational study 69 patients with GCS<15,	N=69 GCS 15 Adults <16	Telephone questionnaire: The	For presence of high risk factor	For presence of high risk factor	N/A	58% of patients had Post concussional syndrome 1 month after injury	Yes	Yes	No	No	Yes and recursive partitionin	1 month follow up	83 originally enrolled, 69 were followed up at 1

Names and evidence level	Rule description	Participants	Outcome measures	Specificity	Sensitivity	Investigation ordering rate	Prevalence	Derived using primary data	Derived using prospect. Data	Validated using primary data	Validated using prospect. Data	Multi-variate modelling	Follow-up	Notes
evidence	with LOC <10 mins, normal CT, no skull fracture, no focal neurology, no alcohol intoxication LOW RISK GROUP PCS occurs in 9% of patients scoring >24 on Hopkins Verbal Learning A test and of those injured by sports >22 on HVLA HIGH RISK PCS occurred	years old Single USA emergency department Consecutive	Rivermead Post concussion symptoms questionnaire. (Patients received a battery of neurobehavioural tests on presentation to the Emergency dept. also)	as rule: Specificity is 93% For absence of low risk factor as rule specificity is 33%	as rule: Sensitivity is 56% For absence of low risk factor as rule sensitivity is 97%							g		month successfully Unfortunately this study is underpowered for recursive partitioning: recommended powering is 10 positive outcomes per test variable used. This would

Names and evidence level	Rule description	Participants	Outcome measures	Specificity	Sensitivity	Investigation ordering rate	Prevalence	Derived using primary data	Derived using prospect. Data	Validated using primary data	Validated using prospect. Data	Multi-variate modelling	Follow-up	Notes
	in 89% of women scoring <9 on the Digit span test and of those injured in falls or MVAs <11.5 on HVLB2 test													<p>have required them to have at least 200 patients in this study just for the derivation set.</p> <p>Therefore their Low risk group contains just 11 patients and the high-risk group has only 24 patients. In addition</p>

Names and evidence level	Rule description	Participants	Outcome measures	Specificity	Sensitivity	Investigation ordering rate	Prevalence	Derived using primary data	Derived using prospect. Data	Validated using primary data	Validated using prospect. Data	Multi-variate modelling	Follow-up	Notes
														50% of the patients in the study fall into a “medium risk” category
Blakely et al ⁵⁰ 1993 Level 3 evidence	This is a review article of the diagnosis of long term sequelae following minor head injury in the context of providing evidence for the judicial service. No original data													
Blostein et al ⁵¹ 1997 Level 4 evidence	Prospective validation study of Neurobehavioral Cognitive Status Examination test	N=107 GCS 13-15, LOC<30 mins Adults over	Neurobehavioral Cognitive Status Examination Initial	97% specificity of this score excluding initial	20% sensitivity in predicting admission GCS <15	N/A	Positive screen was found in 44 patients. This positive screen was correlated only with initial GCS, but not CT results,	Yes	Yes	No	No	No	N/A	107 out of 587 admitted patients with traumatic Brain injury met the

Names and evidence level	Rule description	Participants	Outcome measures	Specificity	Sensitivity	Investigation ordering rate	Prevalence	Derived using primary data	Derived using prospect. Data	Validated using primary data	Validated using prospect. Data	Multi-variate modelling	Follow-up	Notes
	A positive test correlated with abnormal initial GCS score	16years old Single USA level 1 trauma centre Consecutive patients fitting criteria for entry	GCS	GCS 13-14										criteria for the study The initial GCS score is not a reliable predictor or long term disability and therefore this is not a valid outcome measure
Cattelani et al ⁷² 1996 Level 4	Prospective cohort study. Split into 2 groups, as per outcome measure	N=53 GCS13-15, LOC <20 mins	Presence or absence of minimal abnormalities on	N/A	N/A	N/A	No relevant outcome measure							96% of sample were eligible for some form of compensa

Names and evidence level	Rule description	Participants	Outcome measures	Specificity	Sensitivity	Investigation ordering rate	Prevalence	Derived using primary data	Derived using prospect. Data	Validated using primary data	Validated using prospect. Data	Multi-variate modelling	Follow-up	Notes
evidence	No discriminant rule given	Single Italian neurological unit Consecutive	neurological examination or CT scanning or EEG.											tion at the time of interview The outcome measure is presence of contusion of frontal lobes or positive EEG, but it is far from clear as to whether their case group includes all those who will go on to develop

Names and evidence level	Rule description	Participants	Outcome measures	Specificity	Sensitivity	Investigation ordering rate	Prevalence	Derived using primary data	Derived using prospect. Data	Validated using primary data	Validated using prospect. Data	Multi-variate modelling	Follow-up	Notes
														Concussion
Deb et al ¹⁰² 1998 Level 3 evidence	Prospective cross-sectional survey 1 year after head injury Variables that correlated with Edinburgh Rehabilitation status scale: Age, Sex, alcohol, initial GCS, history of previous head injury, MMSE, and NART score	N=148 GCS 13-15, but presence of LOC, skull fracture or CT abnormality Adults >17 years old Scottish Health Authority Databas	GOS Edinburgh Rehabilitation status scale Barthel index MMSE Post concussional questionnaire	N/A	N/A	N/A	3% severe disability 25% moderate disability 70% no disability according to GOS 55% had post-concussional symptoms 30% irritable 29% sleep problems 27%impatience	Yes	Yes	No	No	No	Interview 1 year after Head injury	No control group The most minor patients without LOC and no radiographic abnormality were excluded. Unclear as to how the 148 people were selected from the

Names and evidence level	Rule description	Participants	Outcome measures	Specificity	Sensitivity	Investigation ordering rate	Prevalence	Derived using primary data	Derived using prospect. Data	Validated using primary data	Validated using prospect. Data	Multi-variate modelling	Follow-up	Notes
		e Non consecutive												full database other than self selection after being asked to take part by letter
Haboubi et al ¹⁷⁹ 2001 Level 3 evidence	Prospective experience of a minor head injury clinic, seeing all head injured patients 2 weeks after injury No predictors for disability given	N=639 GCS13-15 Admitted for <48hrs Adults over 16 Single UK	Time to return to work Common symptoms	N/A	N/A	N/A	56% were unable to return to work 2 weeks after discharge. , And 49 patients were not well enough to work 6 weeks post injury. 20 % of those followed up had a headache at 6 weeks	Yes	Yes	No	No	No	Yes	

Names and evidence level	Rule description	Participants	Outcome measures	Specificity	Sensitivity	Investigation ordering rate	Prevalence	Derived using primary data	Derived using prospect. Data	Validated using primary data	Validated using prospect. Data	Multi-variate modelling	Follow-up	Notes
		minor head injuries clinic												
Koelfen et al ²⁵³ 1997 Level 3 evidence	Prospective case-control study Case group: Children 6-15 years old who had a CT after HI at least 1 yr previously and had current normal GOS and no neurological signs Control group:	N=59 All GCS scores Children 6-15 years old Single German Hospital	MRI scan Neuropsychological assessment	N/A	N/A	N/A	66% of children defined as normal Glasgow Outcome Score had abnormalities on MRI scanning All children with normal MRI findings had neuropsychometric testing that matched the control group Children with abnormal MRI had significantly reduced neuropsychometric scores compared to	Yes	Yes	NO	No	No	Yes	Of note 56% of children with an abnormal MRI scan had 'not the slightest abnormality' on neurological testing

Names and evidence level	Rule description	Participants	Outcome measures	Specificity	Sensitivity	Investigation ordering rate	Prevalence	Derived using primary data	Derived using prospect. Data	Validated using primary data	Validated using prospect. Data	Multi-variate modelling	Follow-up	Notes
	59 uninjured children from a paediatric hospital						controls or normal MRI group							
Masson et al ²⁹² 1997 Level 3 evidence	Population based cohort study Looked at a population cohort of head injured patients in a region of France, stratified according to Abbreviated Injury Scale (AIS)	N=407 HI pts All GCS scores Adults and children Study of all injuries serious enough to cause death or hospitalisation in	200 item disability questionnaire GOS	N/A	N/A	N/A	Disability in a population after head injury is 9 per 100,000. Headache, dizziness and anxiety were common whatever the initial head injury severity score. 15% of all head injured patients were still not working due to their head injury at 5 years In the AIS 1-2 group	Yes	Yes	No	No	No	Face to face interview 5 years after initial trauma.	307 of the 407 were successfully followed up. AIS scores rather than GCS scores were used to assess head injury severity No control group

Names and evidence level	Rule description	Participants	Outcome measures	Specificity	Sensitivity	Investigation ordering rate	Prevalence	Derived using primary data	Derived using prospect. Data	Validated using primary data	Validated using prospect. Data	Multi-variate modelling	Follow-up	Notes
		Aquitaine region in France in 1986 Consecutive					5% had some disability 5 years after injury							studied
McDonald et al ²⁹⁵ 1999 Level 4 evidence	Prospective validation of the WAIT test (Wolinsky Amnesia Information test) The WAIT test has good interobserver agreement for use in Closed head injuries	N=75 All GCS scores Adults Single USA neuropsychology service Consecutive	The "GOAT" questionnaire, GCS, Positive CT scan	N/A	N/A	N/A	No convincing disability assessment	Yes	Yes	No	No	No	No	This paper uses other questionnaires, the GCS at time of injury and the CT scan at time of injury as the outcome measure – none are relevant

Names and evidence level	Rule description	Participants	Outcome measures	Specificity	Sensitivity	Investigation ordering rate	Prevalence	Derived using primary data	Derived using prospect. Data	Validated using primary data	Validated using prospect. Data	Multi-variate modelling	Follow-up	Notes
														to long term disability
McGregor et al ²⁹⁶ 1997 Level 3 evidence	This is an interesting review article of published literature looking at the economic aspects of rehabilitation programmes. No UK studies were found. Of the 13 American papers reviewed, no convincing evidence for the effectiveness													

Names and evidence level	Rule description	Participants	Outcome measures	Specificity	Sensitivity	Investigation ordering rate	Prevalence	Derived using primary data	Derived using prospect. Data	Validated using primary data	Validated using prospect. Data	Multi-variate modelling	Follow-up	Notes
	of rehabilitation was found. Also the validity of the costs presented was questioned. The largest study contained 202 patients.													
Millis ³¹¹ 1994 Level 3 evidence	Prospective case control study: 32 patients who had a head injury with GCS 3-12 12 patients with minor head injury GCS 13-15	N=63 GCS 3-15 but stratified to 3-12 and 13-15 Adults	Used Warington Recognition Memory test as outcome measure Comparison	N/A	N/A	N/A	Patients who had a minor head injury but were seeking financial compensation had significantly lower scores on all tests than either similar patients not seeking compensation or patients who had a	Yes	Yes	No	No	No	N/A	Interesting study that highlights the difficulty of assessing disability due to confounding factors

Names and evidence level	Rule description	Participants	Outcome measures	Specificity	Sensitivity	Investigation ordering rate	Prevalence	Derived using primary data	Derived using prospect. Data	Validated using primary data	Validated using prospect. Data	Multi-variate modelling	Follow-up	Notes
	and returned to work 19 patients who were referred by attorneys after minor head injury GCS 13-15	Single USA university rehabilitation hospital Age and sex matched groups	ng groups of differing initial GCS				moderate or severe head injury							such as litigation, But study is not directly relevant to our question
Mittenberg et al ³¹⁵ 1997 Level 2 evidence	Prospective case-control study 38 mild HI patients admitted to hospital with GCS13-15, normal CT,	N=65 All GCS Children Single USA hospital	Structured telephone interview 6 weeks post injury assessing post	N/A	N/A	N/A	11% of Mod-severe group asymptomatic 16% of mild head injury group asymptomatic 40% of orthopaedic controls asymptomatic	Yes	Yes	No	No	No	Yes	It is very interesting to note that 60% of orthopaedic controls had symptoms on the post

National Clinical Guideline Centre, 2014.

Names and evidence level	Rule description	Participants	Outcome measures	Specificity	Sensitivity	Investigation ordering rate	Prevalence	Derived using primary data	Derived using prospect. Data	Validated using primary data	Validated using prospect. Data	Multi-variate modelling	Follow-up	Notes
	<p>27 patients with mod-severe HI with GCS3-12, or abnormal CT</p> <p>47 orthopaedic patients as control</p> <p>Symptoms at 6 weeks correlated with GCS, abnormal neurologic exam, skull fracture, and CT abnormality</p>	Consecutive	concussional syndrome according to ICD-10 and DSM-IV criteria				This study was compared to the adult version and it was found that children have the same frequency of symptoms as adults.							concussional syndrome assessment.
Ogasawa	Prospective	N=76	Multiple	/A	N/A	N/A	Testing at a mean	Yes	Yes	No	No	No	Yes	This paper

Names and evidence level	Rule description	Participants	Outcome measures	Specificity	Sensitivity	Investigation ordering rate	Prevalence	Derived using primary data	Derived using prospect. Data	Validated using primary data	Validated using prospect. Data	Multi-variate modelling	Follow-up	Notes
ra et al ³⁶² 2000 Level 3 evidence	cohort study of GCS13-15 patients Unlike GCS where neurosurgery and abnormal CT are more common with lower GCS, neuropsychiatric measures are similar across the spectrum of GCS 13, 14 and 15	GCS13-15 Adults Single Canadian Psychiatric Dept. Non consecutive	neuropsychiatric scores including : GOAT, GOS, Rivermead, MMSE GHQ, NBR5				period of 44 days post injury found 77% headaches in GCS 15 patients, 70% dizziness, 82% Fatigue.							provides interesting evidence that unlike intracranial injury, post-concussive symptoms do not increase with reducing GCS.
Paret et al ³⁸⁷ 1993	Cross-sectional survey of head injured patients	N=86 23 pts GCS 3-12 63 GCS	Vineland Adaptive Behaviour Scale measured 1 to 3	N/A	N/A	N/A	There was some relationship between adaptive behaviour and severity of injury but this study found	Yes	Yes	No	No	Yes	N/A	62% participation rate Results descriptio

Names and evidence level	Rule description	Participants	Outcome measures	Specificity	Sensitivity	Investigation ordering rate	Prevalence	Derived using primary data	Derived using prospect. Data	Validated using primary data	Validated using prospect. Data	Multi-variate modelling	Follow-up	Notes
Level 4 evidence	Adaptive behaviour was not related to initial severity of injury Better scores was found among girls	13-15 Ages 6-15 From a register of a Children's USA hospital Consecutive pts with mod/Sev HI and random sample of minor HI	years after injury				many confounding variables							n is problematic No control group Their outcome measure is of questionable validity as a marker of long term disability
Powell et al ⁴⁰⁴	Prospective cohort study	N=62	Galveston	N/A	N/A	N/A	Between 51%and 86% of all patients	Yes	Yes	No	No	NO	Follow	Interesting study, well

Names and evidence level	Rule description	Participants	Outcome measures	Specificity	Sensitivity	Investigation ordering rate	Prevalence	Derived using primary data	Derived using prospect. Data	Validated using primary data	Validated using prospect. Data	Multi-variate modelling	Follow-up	Notes
1996 Level 2 evidence	of minor head injured patients who were seen by a psychologist prior to discharge and again at 3 months. Length of Post-traumatic amnesia was related to severity of symptoms.	GCS 13-15 Adults over 16 Single UK hospital Consecutive	Orientati on and amnesia Test: GOAT SOMC Digit span Trail making test AMIPB HADS				had troublesome post concussional symptoms, with headaches and tiredness being the most common symptom.						up at 3 months in person or by telephone 46 followed up in this way	conducted , but no rule derived for the early identificati on of patients with a disability.
Rao et al ⁴¹¹ 1990	This is a study looking at 79 head injured patients who had undergone inpatient rehabilitation after discharge from an acute ward within 3 months of admission. All patients													

Names and evidence level	Rule description	Participants	Outcome measures	Specificity	Sensitivity	Investigation ordering rate	Prevalence	Derived using primary data	Derived using prospect. Data	Validated using primary data	Validated using prospect. Data	Multi-variate modelling	Follow-up	Notes
Level 2 evidence	had been in a coma for at least 6 hours post injury.													
	This study is not relevant to our question													
Rimel et al ⁴¹⁷ 1981 Level 2 evidence	Prospective observational cohort study Patients studied were GCS 13-15 on admission, LOC <20 mins, 48hrs admission or less.	N=424 GCS 13-15 Adults and children Admissions to a USA Hospital Consecutive	At 3 months: Neurological assessment, employment status 133 patients had neuropsychological assessment,	N/A	N/A	N/A	70% had persistent headaches 59% had memory problems 34% of previously employed people were now unemployed	Yes	Yes	No	No	No	Yes	424 of 538 were successfully followed up, 27 of whom would only have a telephone interview No control group used
Ruff et	Case series of 9 patients with minor head													

Names and evidence level	Rule description	Participants	Outcome measures	Specificity	Sensitivity	Investigation ordering rate	Prevalence	Derived using primary data	Derived using prospect. Data	Validated using primary data	Validated using prospect. Data	Multi-variate modelling	Follow-up	Notes
al ⁴³² 1994 Level 4 evidence	injuries, negative CT and MRI but positive neuropsychological tests and Positive PET scanning.													
	Not relevant to our search for discriminant variables that predict disability													
Thornhill et al ⁵¹² 2000 Level 2 evidence	Prospective cohort study to determine the frequency of disability in adults admitted to hospital No rule derived Only age over 40, pre-existing physical limitations	N=549 All GCS results stratified Adults over 14 years old Single Scottish Hospital Random	Glasgow Outcome score Problem orientated questionnaire. At 1 year post injury	N/A	N/A	N/A	45-48% of all patients have some disability at 1 year	Yes	Yes	No	No	YES	Yes	21% of mild head injuries have severe disability, and 30 % have moderate disability at 1 year

Names and evidence level	Rule description	Participants	Outcome measures	Specificity	Sensitivity	Investigation ordering rate	Prevalence	Derived using primary data	Derived using prospect. Data	Validated using primary data	Validated using prospect. Data	Multi-variate modelling	Follow-up	Notes
	and history of brain illness were found to be univariate predictors for disability	sample from consecutive patients												

O.8 Adult observation proforma

The Newcastle upon Tyne Hospitals **NHS**
NHS Foundation Trust

Affix patient identification label in box below or complete details

Surname	Patient i.d.No.
Forename	D.O.B. DDMMYYYY
Address	NHS No.
	Sex. Male / Female
Postcode	

NEUROLOGICAL OBSERVATION CHART

				DATE																																																								
				TIME (24hr clock)																																																								
COMASCAL E	Eyes open	Spontaneously	4																																																									
		To speech	3																																																									
		To pain	2																																																									
		None	1																																																									
	Best verbal response	Orientated	5																																																									
		Confused	4																																																									
		Inappropriate Words	3																																																									
		Incomprehensible Sounds	2																																																									
	Best motor response	None	1																																																									
		Obey Commands	6																																																									
Localise Pain		5																																																										
Flexion to Pain		4																																																										
Abnormal Flexion		3																																																										
			2																																																									
			1																																																									
G.C.S. Total																																																												
				<table border="1" style="width: 100%; text-align: center;"> <tr> <td rowspan="10" style="writing-mode: vertical-rl; transform: rotate(180deg);">Pupil Scale (mm)</td> <td>• 1</td> <td rowspan="10" style="writing-mode: vertical-rl; transform: rotate(180deg);">Pain Score / O₂ Sat MEWS</td> <td rowspan="10" style="writing-mode: vertical-rl; transform: rotate(180deg);">Pulse Rate</td> <td>41.0</td> <td>3</td> </tr> <tr> <td>• 2</td> <td>40.0</td> <td>2</td> </tr> <tr> <td>• 3</td> <td>39.0</td> <td>1</td> </tr> <tr> <td>• 4</td> <td>38.0</td> <td>0</td> </tr> <tr> <td>• 5</td> <td>37.0</td> <td>0</td> </tr> <tr> <td>• 6</td> <td>36.0</td> <td>2</td> </tr> <tr> <td>• 7</td> <td>35.0</td> <td>2</td> </tr> <tr> <td>• 8</td> <td>34.0</td> <td>3</td> </tr> <tr> <td>• 9</td> <td>33.0</td> <td>3</td> </tr> <tr> <td>• 10</td> <td>32.0</td> <td>3</td> </tr> </table>												Pupil Scale (mm)	• 1	Pain Score / O ₂ Sat MEWS	Pulse Rate	41.0	3	• 2	40.0	2	• 3	39.0	1	• 4	38.0	0	• 5	37.0	0	• 6	36.0	2	• 7	35.0	2	• 8	34.0	3	• 9	33.0	3	• 10	32.0	3												
Pupil Scale (mm)	• 1	Pain Score / O ₂ Sat MEWS	Pulse Rate	41.0	3																																																							
	• 2			40.0	2																																																							
	• 3			39.0	1																																																							
	• 4			38.0	0																																																							
	• 5			37.0	0																																																							
	• 6			36.0	2																																																							
	• 7			35.0	2																																																							
	• 8			34.0	3																																																							
	• 9			33.0	3																																																							
	• 10			32.0	3																																																							
				<table border="1" style="width: 100%; text-align: center;"> <tr> <td rowspan="10" style="writing-mode: vertical-rl; transform: rotate(180deg);">Systemic Pressure (mmHg)</td> <td>260</td> <td rowspan="10" style="writing-mode: vertical-rl; transform: rotate(180deg);">Pain Score / O₂ Sat MEWS</td> <td rowspan="10" style="writing-mode: vertical-rl; transform: rotate(180deg);">Pulse Rate</td> <td>200</td> <td>3</td> </tr> <tr> <td>250</td> <td>190</td> <td>3</td> </tr> <tr> <td>240</td> <td>180</td> <td>3</td> </tr> <tr> <td>230</td> <td>170</td> <td>3</td> </tr> <tr> <td>220</td> <td>160</td> <td>3</td> </tr> <tr> <td>210</td> <td>150</td> <td>3</td> </tr> <tr> <td>200</td> <td>140</td> <td>3</td> </tr> <tr> <td>190</td> <td>130</td> <td>3</td> </tr> <tr> <td>180</td> <td>120</td> <td>3</td> </tr> <tr> <td>170</td> <td>110</td> <td>3</td> </tr> </table>												Systemic Pressure (mmHg)	260	Pain Score / O ₂ Sat MEWS	Pulse Rate	200	3	250	190	3	240	180	3	230	170	3	220	160	3	210	150	3	200	140	3	190	130	3	180	120	3	170	110	3												
Systemic Pressure (mmHg)	260	Pain Score / O ₂ Sat MEWS	Pulse Rate	200	3																																																							
	250			190	3																																																							
	240			180	3																																																							
	230			170	3																																																							
	220			160	3																																																							
	210			150	3																																																							
	200			140	3																																																							
	190			130	3																																																							
	180			120	3																																																							
	170			110	3																																																							
				<table border="1" style="width: 100%; text-align: center;"> <tr> <td rowspan="10" style="writing-mode: vertical-rl; transform: rotate(180deg);">Pupil Scale (mm)</td> <td>10</td> <td rowspan="10" style="writing-mode: vertical-rl; transform: rotate(180deg);">Pain Score / O₂ Sat MEWS</td> <td rowspan="10" style="writing-mode: vertical-rl; transform: rotate(180deg);">Pulse Rate</td> <td>100</td> <td>3</td> </tr> <tr> <td>9</td> <td>90</td> <td>3</td> </tr> <tr> <td>8</td> <td>80</td> <td>3</td> </tr> <tr> <td>7</td> <td>70</td> <td>3</td> </tr> <tr> <td>6</td> <td>60</td> <td>3</td> </tr> <tr> <td>5</td> <td>50</td> <td>3</td> </tr> <tr> <td>4</td> <td>40</td> <td>3</td> </tr> <tr> <td>3</td> <td>30</td> <td>3</td> </tr> <tr> <td>2</td> <td>20</td> <td>3</td> </tr> <tr> <td>1</td> <td>10</td> <td>3</td> </tr> </table>												Pupil Scale (mm)	10	Pain Score / O ₂ Sat MEWS	Pulse Rate	100	3	9	90	3	8	80	3	7	70	3	6	60	3	5	50	3	4	40	3	3	30	3	2	20	3	1	10	3												
Pupil Scale (mm)	10	Pain Score / O ₂ Sat MEWS	Pulse Rate	100	3																																																							
	9			90	3																																																							
	8			80	3																																																							
	7			70	3																																																							
	6			60	3																																																							
	5			50	3																																																							
	4			40	3																																																							
	3			30	3																																																							
	2			20	3																																																							
	1			10	3																																																							
				<table border="1" style="width: 100%; text-align: center;"> <tr> <td rowspan="10" style="writing-mode: vertical-rl; transform: rotate(180deg);">PUPILS</td> <td>Right</td> <td rowspan="10" style="writing-mode: vertical-rl; transform: rotate(180deg);">Pain Score / O₂ Sat MEWS</td> <td rowspan="10" style="writing-mode: vertical-rl; transform: rotate(180deg);">Pulse Rate</td> <td>5</td> <td>Sluggish</td> </tr> <tr> <td>Left</td> <td>+</td> <td>Reacts</td> </tr> <tr> <td>Size Reaction</td> <td>-</td> <td>No Reaction</td> </tr> <tr> <td>Size Reaction</td> <td>c.</td> <td>Eye Closed</td> </tr> <tr> <td></td> <td></td> <td></td> <td></td> <td></td> </tr> <tr> <td></td> <td></td> <td></td> <td></td> <td></td> </tr> <tr> <td></td> <td></td> <td></td> <td></td> <td></td> </tr> <tr> <td></td> <td></td> <td></td> <td></td> <td></td> </tr> <tr> <td></td> <td></td> <td></td> <td></td> <td></td> </tr> <tr> <td></td> <td></td> <td></td> <td></td> <td></td> </tr> </table>												PUPILS	Right	Pain Score / O ₂ Sat MEWS	Pulse Rate	5	Sluggish	Left	+	Reacts	Size Reaction	-	No Reaction	Size Reaction	c.	Eye Closed																														
PUPILS	Right	Pain Score / O ₂ Sat MEWS	Pulse Rate	5	Sluggish																																																							
	Left			+	Reacts																																																							
	Size Reaction			-	No Reaction																																																							
	Size Reaction			c.	Eye Closed																																																							
				<table border="1" style="width: 100%; text-align: center;"> <tr> <td rowspan="10" style="writing-mode: vertical-rl; transform: rotate(180deg);">LIMB MOVEMENT</td> <td>Normal power</td> <td rowspan="10" style="writing-mode: vertical-rl; transform: rotate(180deg);">Pain Score / O₂ Sat MEWS</td> <td rowspan="10" style="writing-mode: vertical-rl; transform: rotate(180deg);">Pulse Rate</td> <td colspan="2">Record right (R) and left (L) separately if there is a difference between the two sides</td> </tr> <tr> <td>Mild weakness</td> <td></td> </tr> <tr> <td>Severe weakness</td> <td></td> </tr> <tr> <td>Spastic flexion</td> <td></td> </tr> <tr> <td>Extension</td> <td></td> </tr> <tr> <td>No response</td> <td></td> </tr> <tr> <td></td> <td></td> <td></td> <td></td> <td></td> </tr> <tr> <td></td> <td></td> <td></td> <td></td> <td></td> </tr> <tr> <td></td> <td></td> <td></td> <td></td> <td></td> </tr> <tr> <td></td> <td></td> <td></td> <td></td> <td></td> </tr> </table>												LIMB MOVEMENT	Normal power	Pain Score / O ₂ Sat MEWS	Pulse Rate	Record right (R) and left (L) separately if there is a difference between the two sides		Mild weakness		Severe weakness		Spastic flexion		Extension		No response																														
LIMB MOVEMENT	Normal power	Pain Score / O ₂ Sat MEWS	Pulse Rate	Record right (R) and left (L) separately if there is a difference between the two sides																																																								
	Mild weakness																																																											
	Severe weakness																																																											
	Spastic flexion																																																											
	Extension																																																											
	No response																																																											

postprint

MUTH189

O.9 Paediatric observation proformas

Record no.	Date & Name	Time																				
Eye opening	4 Open spontaneously																					
	3 Opening to verbal command																					
	2 Opening to pain																					
	1 No opening																					
Verbal child																					Best Grimace Response	
Verbal response	5 Alert, usual ability																				5 Spontaneous facial activity	
	4 Less than usual ability																				4 Less than usual	
	3 Cries inappropriately																				3 Strong grimace to pain	
	2 Occasionally whimper+or moans																				2 Mild grimace to pain	
	1 No vocal response																				1 No pain response	
Motor response	6 Normal movement																					
	5 Localises pain/withdraws to touch																					
	4 Withdrawal to painful stimuli																					
	3 Abnormal flexion to pain																					
	2 Abnormal extension to pain																					
	1 No motor response to pain																					
GCS total (out of 15)																						GCS total (out of 15)
Pupil size (mm) 1 ● 2 ● 3 ● 4 ● 5 ● 6 ● 7 ● 8 ●	BP / PULSE / RR																					Temp (centigrade) (red ink)
		210																				40
		200																				39.5
		190																				39
		180																				38.5
		170																				38
		160																				37.5
		150																				37
		140																				36.5
		130																				36
		120																				35.5
		110																				
	100																					
	90																					
	80																					
	70																					
	60																					
	50																					
	40																					
	30																					
	20																					
	10																					
Right pupil		Size																				Pupil reactions
		Reaction																				sluggish s
Left pupil		Size																				closed c
		Reaction																				reaction +
Arm Movement	Normal power																					no reaction -
	Mild weakness																					
	Severe weakness																					
	Spontaneous																					
	Painful stimuli																					
	No response																					
Leg Movement	Normal power																					Record each limb separately if there are significant differences
	Mild weakness																					R = right
	Severe weakness																					L = left
	Spontaneous																					
	Painful stimuli																					
	No response																					
	Pulse Oximetry																					Pulse oximetry
	Oxygen %/ L's (circle)																					Oxygen %/ L's (circle)

O.10 Letter of referral to neurosurgical department

Referring hospital: _____		Consultant: _____		A&E number: <input type="checkbox"/> <input type="checkbox"/> <input type="checkbox"/> <input type="checkbox"/> <input type="checkbox"/> <input type="checkbox"/> <input type="checkbox"/> <input type="checkbox"/> <input type="checkbox"/> <input type="checkbox"/> <input type="checkbox"/>									
Name: _____		Sex: Male <input type="checkbox"/> Female <input type="checkbox"/>		Age: <input type="checkbox"/> <input type="checkbox"/> <input type="checkbox"/>									
Address: _____		DOB: <input type="checkbox"/> <input type="checkbox"/> <input type="checkbox"/> <input type="checkbox"/> <input type="checkbox"/> <input type="checkbox"/>											
Date of incident: <input type="checkbox"/> <input type="checkbox"/> <input type="checkbox"/> <input type="checkbox"/> <input type="checkbox"/> <input type="checkbox"/>		Time of incident: <input type="checkbox"/> <input type="checkbox"/> : <input type="checkbox"/> <input type="checkbox"/>		Time of admission: <input type="checkbox"/> <input type="checkbox"/> : <input type="checkbox"/> <input type="checkbox"/>									
History: _____													
Physiological observations													
	Time	HR	BP	RR	O ₂ sat	eye	GCS motor	verbal	Right pupil reacts	size	Left pupil reacts	size	
on arrival													
on transfer													
Cranial injuries: _____						CT scan at referring hospital: Yes <input type="checkbox"/> No <input type="checkbox"/>							
Extracranial injuries: (proven or suspected)						Chest							
C-spine: _____						Abdomen:							
Pelvis: _____						Face/neck:							
Thoracolumbar: _____													
Limbs: _____													
Other (specify): _____													
Past medical history: _____													
Current medications: _____													
Interventions													
Airway:	Guedel	<input type="checkbox"/>	ETT	<input type="checkbox"/>	Other		<input type="checkbox"/>	None		<input type="checkbox"/>			
Ventilation:	Spontaneous	<input type="checkbox"/>	IPPV	<input type="checkbox"/>									
Nasogastric tube:	Yes	<input type="checkbox"/>	No	<input type="checkbox"/>									
Urinary catheter:	Yes	<input type="checkbox"/>	No	<input type="checkbox"/>									
Drugs given						IV fluids		Volume					
Tetanus toxoid						Crystalloid							
						Colloid							
						Blood							
Time						Time		Time					
pO ₂						Hb		Na ⁺					
pCO ₂						WCC		K ⁺					
H ⁺						Platelets		C ⁻					
HCO ₂						Glucose		HCO ₂					
						X-match		Urea					
								Creat.					
Next of kin:						Tel. no:		Notified: yes <input type="checkbox"/> no <input type="checkbox"/>					
Valuables: patient <input type="checkbox"/> relatives <input type="checkbox"/> police <input type="checkbox"/> none <input type="checkbox"/>						Clothing: patient <input type="checkbox"/> relatives <input type="checkbox"/> police <input type="checkbox"/> none <input type="checkbox"/>							
NB: Have you excluded all possible sites of blood loss? <input type="checkbox"/>													
Transfer with the patient:						Observation charts <input type="checkbox"/>		Medical notes <input type="checkbox"/>		X-rays <input type="checkbox"/>			
Signed: _____						Print: _____		Grade: _____					
Receiving neurosurgeon: _____						Grade: _____		Transfer time: _____					

Source: Based, with permission, on the letter developed by the Scottish Trauma Audit Group.

Keaney J et al. (2000) A standardised neurosurgical referral letter for the inter-hospital transfer of head injury patients. *Journal of Accident and Emergency Medicine* 17; 257-60.

O.11 The Glasgow Coma Scale for adults

The Glasgow Coma Scale is scored between 3 and 15, 3 being the worst, and 15 the best. It is composed of three parameters: Best Eye Response, Best Verbal Response, Best Motor Response. The definition of these parameters is given below.

Best Eye Response. (4)

- 20.No eye opening.
- 21.Eye opening to pain.
- 22.Eye opening to verbal command.
- 23. Eyes open spontaneously.

Best Verbal Response. (5)

- 24.No verbal response
- 25.Incomprehensible sounds.
- 26.Inappropriate words.
- 27.Confused
- 28.Orientated

Best Motor Response. (6)

- 29.No motor response.
- 30.Extension to pain.
- 31.Abnormal flexion to pain.
- 32.Normal flexion to pain.
- 33.Localising pain.
- 34. Obeys Commands.

O.12 Paediatric version of the Glasgow Coma Scale

The Paediatric version of the Glasgow Coma Scale is scored between 3 and 15, 3 being the worst, and 15 the best. It is composed of three parameters: Best Eye Response, Best Verbal Response, Best Motor Response. The definition of these parameters is given below.

Best Eye Response. (4)

- 35.No eye opening.
- 36.Eye opening to pain.
- 37.Eye opening to verbal command.
- 38.Eyes open spontaneously.

Best Verbal Response. (5)

- 39.No vocal response.
- 40.Occasionally whimpers and/or moans.
- 41.Cries inappropriately.
- 42.Less than usual ability and/or spontaneous irritable cry.
- 43.Alert, babbles, coos, words or sentences to usual ability.

Communication with the infant or child's caregivers is required to establish the best usual verbal response. A 'grimace' alternative to verbal responses should be used in pre-verbal or intubated patients.

Best Grimace Response (5)

- 44.No response to pain.
- 45.Mild grimace to pain.
- 46.Vigorous grimace to pain.
- 47.Less than usual spontaneous ability or only response to touch stimuli.
- 48.Spontaneous normal facial/oro-motor activity.

Best Motor Response. (6)

- 49.No motor response to pain.
- 50.Abnormal extension to pain (decerebrate).
- 51.Abnormal flexion to pain (decorticate).
- 52.Withdrawal to painful stimuli.
- 53.Localises to painful stimuli or withdraws to touch.
- 54.Obeys commands or performs normal spontaneous movements.

O.13 Deleted and amended recommendations

O.13.1 Recommendations proposed for deletion:

The table shows recommendations from 2007 that NICE proposes deleting in the 2014 update. The right-hand column gives the replacement recommendation, or explains the reason for the deletion if there is no replacement recommendation.

Recommendation in 2003 or 2007 guideline	Comment
<p>In the absence of any of the factors listed in boxes 1 and 2 the helpline should advise the injured person to seek medical advice from community services (for example, general practice) if any of the following factors are present.</p> <ul style="list-style-type: none"> • Adverse social factors (for example, no one able to supervise the injured person at home). • Continuing concern by the injured person or their carer about the diagnosis. [2003] (1.2.1.3) 	<p>Replaced by recommendation 1.1.3:</p> <p>1.1.3 Telephone advice services (for example, NHS 111 or emergency department helplines) should refer patients who have sustained a head injury to a hospital emergency department if they have any of the following risk factors:</p> <ul style="list-style-type: none"> • Any loss of consciousness ('knocked out') as a result of the injury, from which the person has now recovered. • Amnesia for events before or after the injury ('problems with memory'). • Persistent headache since the injury. • Any vomiting episodes since the injury. • Any previous brain surgery. • Any history of bleeding or clotting disorders. • Current anticoagulant therapy such as warfarin. • Current drug or alcohol intoxication. • There are any safeguarding concerns (for example, possible non-accidental injury or a vulnerable person is affected). • Irritability or altered behaviour ('easily distracted', 'not themselves', 'no concentration', 'no interest in things around them'), particularly in infants and children aged under 5 years. • Continuing concern by helpline staff about the diagnosis. [2003, amended 2014]
<p>MRI is contraindicated in both head and cervical spine investigations unless there is absolute certainty that the patient does not harbour an incompatible device, implant or foreign body. [2003] (1.4.2.3)</p>	<p>Part of routine screening, this recommendation is redundant.</p>
<p>Unless the CT result is required within 1 hour, it is acceptable to admit a patient for effective overnight observation and delay the CT scan until the next morning if the patient presents out of hours and any of the following risk factors are present in addition to a period of loss of consciousness or amnesia: (1.4.2.6)</p>	<p>The content of this recommendation is covered in the recommendations for CT under 1hr and 8hr, which update and replace this.</p> <p>1.4.5 For adults who have sustained a head injury and have any of the following risk factors, perform a CT head scan within 1 hour of the risk factor being identified:</p> <ul style="list-style-type: none"> • GCS less than 13 on initial assessment in the emergency department. • GCS less than 15 at 2 hours after the injury on assessment in the emergency department. • Suspected open or depressed skull fracture.

National Clinical Guideline Centre, 2014.

Recommendation in 2003 or 2007 guideline	Comment
	<ul style="list-style-type: none"> • Any sign of basal skull fracture (haemotympanum, 'panda' eyes, cerebrospinal fluid leakage from the ear or nose, Battle's sign). • Post-traumatic seizure. • Focal neurological deficit. • More than one episode of vomiting. <p>A provisional written radiologist's report should be available within 1 hour of the scan being performed. [new 2014]</p> <p>1.4.6 For adults with any of the following risk factors who have experienced some loss of consciousness or amnesia since the injury, perform a CT head scan within 8 hours of the head injury:</p> <ul style="list-style-type: none"> • Age 65 years or older. • Any history of bleeding or clotting disorders. • Dangerous mechanism of injury (a pedestrian or cyclist struck by a motor vehicle, an occupant ejected from a motor vehicle or a fall from a height of greater than 1 metre or 5 stairs). • More than 30 minutes' retrograde amnesia of events immediately before the head injury. <p>A provisional written radiologist's report should be available within 1 hour of the scan being performed. [new 2014]</p>
<p>CT imaging of the head should be performed (that is, imaging carried out and results analysed) within 1 hour of the request having been received by the radiology department in those patients where imaging is requested because of any of the risk factors in box 7. [2003, amended 2007] (1.4.2.11)</p>	<p>The GDG considered that CG56 duplicated recommendations and that separating who to select for imaging and when to perform imaging was unhelpful and unclear. This recommendation combines adults and children and the GDG felt that it was clearer to separate this out. The GDG requested that this recommendation is deleted and the timing should be detailed within the selection of patients for imaging recommendations for adults and children. (Recommendations 1.4.5 - 1.4.10).</p>
<p>Patients who have any of the risk factors in box 8 and none of the risk factors in box 7 should have CT imaging of the head performed within 8 hours of the injury (imaging should be performed immediately in these patients if they present 8 hours or more after their injury). [2003, amended 2007] (1.4.2.12)</p>	<p>The GDG considered that CG56 duplicated recommendations and that separating who to select for imaging and when to perform imaging was unhelpful and unclear. This recommendation combines adults and children and the GDG felt that it was clearer to separate this out. The GDG requested that this recommendation is deleted and the timing should be detailed within the selection of patients for imaging recommendations for adults and children. (Recommendations 1.4.5 - 1.4.10).</p>
<p>The current initial investigation of choice for the detection of injuries to the cervical spine is the plain radiograph. Three views should be obtained and be of sufficient quality for reliable interpretation. However, in certain circumstances CT is preferred. (1.4.3.1.)</p>	<p>Replaced by recommendations 1.5.8 - 1.5.13.</p>
<p>Adult patients should have three-view radiographic</p>	<p>Replaced by recommendations 1.4.7 - 1.4.12</p>

Recommendation in 2003 or 2007 guideline	Comment
<p>imaging of the cervical spine requested immediately if any of the points listed below apply:</p> <ul style="list-style-type: none"> • There is neck pain or midline tenderness with: • age 65 years or older , or • dangerous mechanism of injury (fall from greater than 1 m or five stairs; axial load to head for example, diving; high-speed motor vehicle collision; rollover motor accident; ejection from a motor vehicle; accident involving motorized recreational vehicles; bicycle collision). • It is not considered safe to assess the range of movement in the neck for reasons other than those above. • It is considered safe to assess the range of movement in the neck and, on assessment, the patient cannot actively rotate the neck to 45 degrees to the left and right; safe assessment can be carried out if the patient. (1.4.3.9) 	
<p>Adult patients who have any of the following risk factors should have CT imaging of the cervical spine requested immediately:</p> <ul style="list-style-type: none"> • patients with a GCS below 13 on initial assessment • those that have been intubated • plain film series is technically inadequate (for example, desired view unavailable), suspicious or definitely abnormal • there is continued clinical suspicion of injury despite a normal X-ray • a definitive diagnosis of cervical spine injury is required urgently (for example, prior to surgery) and the patient is having other body areas scanned for head injury or multi-region trauma. [2007] (1.4.3.10) 	<p>Replaced by recommendations 1.4.7 - 1.4.12</p>
<p>Children aged 10 years or more can be treated as adults for the purposes of cervical spine imaging. [2003] (1.4.3.11)</p>	<p>Replaced by recommendations 1.4.7 - 1.4.12</p>
<p>Children under 10 years of age with GCS of 8 or less should have CT imaging of the cervical spine within 1 hour of presentation or when they are sufficiently stable. [2007] (1.4.3.14)</p>	<p>The GDG considered that CG 56 duplicated recommendations and that separating who to select for imaging and when to perform imaging was unhelpful and unclear. This recommendation combines adults and children and the GDG felt that it was clearer to separate this out. The GDG requested that this recommendation is deleted and the timing should be detailed within the selection of patients for imaging recommendations for adults and children. Replaced by recommendations 1.5.8 - 1.5.13.</p>
<p>Imaging of the cervical spine should be performed within 1 hour of a request having been received by</p>	<p>The GDG considered that CG 56 duplicated recommendations and that separating who to</p>

Recommendation in 2003 or 2007 guideline	Comment
<p>the radiology department or when the patient is sufficiently stable. Where a request for urgent CT imaging of the head (that is, within 1 hour) has also been received, the cervical spine imaging should be carried out simultaneously. [2003, amended 2007] (1.4.3.15)</p>	<p>select for imaging and when to perform imaging was unhelpful and unclear. This recommendation combines adults and children and the GDG felt that it was clearer to separate this out. The GDG requested that this recommendation is deleted and the timing should be detailed within the selection of patients for imaging recommendations for adults and children. Replaced by recommendations 1.5.8 - 1.5.13.</p>
<p>All patients with any degree of head injury who are deemed safe for discharge from an emergency department or the observation ward should receive verbal advice and a written head injury advice card. The details of the card should be discussed with the patients and their carers. If necessary (for example, patients with literacy problems, visual impairment or speaking languages without a written format), other formats (for example, tapes) should be used to communicate this information. Communication in languages other than English should also be facilitated. [2003] (1.8.1.2)</p>	<p>Replaced by recommendations 1.9.7 and 1.9.8</p>
<p>The risk factors outlined in the card should be the same as those used in the initial community setting to advise patients on emergency department attendance. Patients and carers should also be alerted to the possibility that some patients may make a quick recovery, but go on to experience delayed complications. Instructions should be included on contacting community services in the event of delayed complications. [2003] (1.8.1.3)</p>	<p>Replaced by recommendations 1.9.7 and 1.9.8</p>
<p>Suggested written advice cards for patients and carers are available from the NICE website (see page 43 for further details). [2003] (1.8.1.5)</p>	<p>Recommendation is out of date.</p>
<p>No infants or children presenting with head injuries that require imaging of the head or cervical spine should be discharged until assessed by a clinician experienced in the detection of non-accidental injury. [2003] (1.8.2.5)</p>	<p>Replaced by recommendation 1.3.10 A clinician with training in safeguarding should be involved in the initial assessment of any patient with a head injury presenting to the emergency department. If there are any concerns identified, follow local safeguarding procedures appropriate to the patient's age. [2003, amended 2014]</p>
<p>It is expected that all personnel involved in the assessment of infants and children with head injury should have training in the detection of non-accidental injury. [2003] (1.8.2.6)</p>	<p>Replaced by recommendation 1.3.10 A clinician with training in safeguarding should be involved in the initial assessment of any patient with a head injury presenting to the emergency department. If there are any concerns identified, follow local safeguarding procedures appropriate to the patient's age. [2003, amended 2014]</p>
<p>Every patient who has undergone imaging of their head and/or been admitted to hospital (that is, those</p>	<p>GDG felt that this does not happen and consider it unnecessary.</p>

Recommendation in 2003 or 2007 guideline	Comment
initially deemed to be at high risk for clinically important brain injury) should be routinely referred to their GP for follow-up within a week after discharge. [2003] (1.8.3.1)	
A communication (letter or email) should be generated for all school-aged children who received head or cervical spine imaging, and sent to the relevant GP and school nurse within 1 week of the end of the hospital episode. This letter should include details of the clinical history and examination. [2003, amended 2007] (1.8.5.2)	Replaced by recommendation: 1.9.11 For all patients who have attended the emergency department with a head injury, write to their GP within 48 hours of discharge, giving details of clinical history and examination. This letter should also be shared with health visitors (for pre-school children) and school nurses (school-age children). If appropriate, provide a copy of the letter for the patient and their family or carer. [new 2014]
A communication (letter or email) should be generated for all pre-school children who received head or cervical spine imaging, and sent to the GP and health visitor within 1 week of the end of the hospital episode. This letter should include details of the clinical history and examination. [2003, amended 2007] (1.8.5.3)	Replaced by recommendation: 1.9.11 For all patients who have attended the emergency department with a head injury, write to their GP within 48 hours of discharge, giving details of clinical history and examination. This letter should also be shared with health visitors (for pre-school children) and school nurses (school-age children). If appropriate, provide a copy of the letter for the patient and their family or carer. [new 2014]

O.13.2 Amended recommendation wording (change to meaning)

Recommendations are labelled [2003, amended 2014], [2007, amended 2014] or [2003, amended 2007 and 2014] if the evidence has not been reviewed but changes have been made to the recommendation wording (indicated by highlighted text) that change the meaning.

Recommendation in 2003 or 2007 guideline	Recommendation in current guideline	Reason for change
<p>1.1.4.1 There should be a protocol for all staff to introduce themselves to family members or carers and briefly explain what they are doing. In addition a photographic board with the names and titles of personnel in the hospital departments caring for patients with head injury can be helpful. [2003]</p>	<p>1.6.1 Staff caring for patients with a head injury should introduce themselves to family members or carers and briefly explain what they are doing. [2003, amended 2014]</p>	<p>Second sentence detailing photographic board has been removed The GDG considered this to be a safety/security risk for staff in some departments.</p>
<p>1.2.1.1 Telephone advice services (for example, NHS Direct, emergency department helplines) should refer people who have sustained a head injury to the emergency ambulance services (that is, 999) for emergency transport to the emergency department if they have experienced any of the risk factors in box 1 (alternative terms to facilitate communication are in parentheses). [2003, amended 2007]</p>	<p>1.1.2 Telephone advice services (for example, NHS 111, emergency department helplines) should refer patients who have sustained a head injury to the emergency ambulance services (that is, 999) for emergency transport to the emergency department if they have experienced any of the following:</p> <ul style="list-style-type: none"> • Unconsciousness, or lack of full consciousness (for example, problems keeping eyes open). • Any focal neurological deficit since the injury. • Any suspicion of a skull fracture or penetrating head injury. • Any seizure ('convulsion' or 'fit') since the injury. • A high-energy head injury. • The injured person or their carer is incapable of transporting the injured person safely to the hospital emergency department without the use of ambulance services (providing any other risk factor indicating emergency department referral is present). [2003, amended 2007 and 2014] 	<p>Updated to NHS 111</p>
<p>1.2.1.2 Telephone advice services (for example, NHS Direct, emergency department helplines) should refer people who have sustained a head injury to a hospital emergency department if the history related indicates the presence of any of the risk factors in box 2 (alternative terms to facilitate communication</p>	<p>1.1.3 Telephone advice services (for example, NHS 111 or emergency department helplines) should refer patients who have sustained a head injury to a hospital emergency department if they have any of the following risk factors:</p> <ul style="list-style-type: none"> • Any loss of consciousness ('knocked out') as a result of the 	<p>Updated to NHS 111 'Age 65 years or older' as a factor for referring to the emergency department' - removed (equality consideration). 'Adverse social factors' removed as the GDG thought</p>

Recommendation in 2003 or 2007 guideline	Recommendation in current guideline	Reason for change
are in parentheses). [2003]	<p>injury, from which the person has now recovered.</p> <ul style="list-style-type: none"> • Amnesia for events before or after the injury ('problems with memory'). • Persistent headache since the injury. • Any vomiting episodes since the injury. • Any previous brain surgery. • Any history of bleeding or clotting disorders. • Current anticoagulant therapy such as warfarin. • Current drug or alcohol intoxication. • There are any safeguarding concerns (for example, possible non-accidental injury or a vulnerable person is affected). • Irritability or altered behaviour ('easily distracted', 'not themselves', 'no concentration', 'no interest in things around them'), particularly in infants and children aged under 5 years. • Continuing concern by helpline staff about the diagnosis. [2003, amended 2014] 	<p>this was an inappropriate way of describing patients.</p> <p>Extra bullet point added in to highlight safeguarding concerns (widely used terminology).</p>
<p>1.2.2.1 Community health services (general practice, ambulance crews, NHS walk-in centres, dental practitioners) and NHS minor injury clinics should refer patients who have sustained a head injury to a hospital emergency department, using the ambulance service if deemed necessary (see section 1.3.1), if any of the risk factors listed in box 3 are present. [2003, amended 2007]</p>	<p>1.1.4 Community health services (general practice, ambulance crews, NHS walk-in centres, dental practitioners) and NHS minor injury clinics should refer patients who have sustained a head injury to a hospital emergency department, using the ambulance service if deemed necessary, if any of the following are present:</p> <ul style="list-style-type: none"> • Glasgow Coma Scale (GCS) score of less than 15 on initial assessment. • Any loss of consciousness as a result of the injury. • Any focal neurological deficit since the injury. • Any suspicion of a skull fracture or penetrating head injury since the injury. • Amnesia for events before or 	<p>'Age 65 years or older' as a factor for referring to the emergency department' - removed (equality consideration) and risk covered by loss of consciousness rec.</p> <p>Extra bullet point added in to highlight safeguarding concerns (widely used terminology).</p> <p>Clinical judgement re vomiting reflects high incidence of single vomit in younger children in head injury which alone is not of concern</p>

Recommendation in 2003 or 2007 guideline	Recommendation in current guideline	Reason for change
	<p>after the injury¹.</p> <ul style="list-style-type: none"> • Persistent headache since the injury. • Any vomiting episodes since the injury (clinical judgement should be used regarding the cause of vomiting in those aged 12 years or younger and the need for referral). • Any seizure since the injury. • Any previous brain surgery. • A high-energy head injury. • Any history of bleeding or clotting disorders. • Current anticoagulant therapy such as warfarin. • Current drug or alcohol intoxication. • There are any safeguarding concerns (for example, possible non-accidental injury or a vulnerable person is affected). • Continuing concern by the professional about the diagnosis. [2003, amended 2007 and 2014] 	
<p>1.2.2.2 In the absence of any the factors listed in box 3, the professional should consider referral to an emergency department if any of the following factors are present depending on their own judgement of severity.</p> <ul style="list-style-type: none"> • Irritability or altered behaviour, particularly in infants and young children (that is, aged under 5 years). • Visible trauma to the head not covered above but still of concern to the professional. • Adverse social factors (for example, no one able to supervise the injured person at home). • Continuing concern by the injured person or their carer about the diagnosis. [2003] 	<p>1.1.5 In the absence of any risk factors in recommendation 1.1.4, consider referral to an emergency department if any of the following factors are present, depending on judgement of severity:</p> <ul style="list-style-type: none"> • Irritability or altered behaviour, particularly in infants and children aged under 5 years. • Visible trauma to the head not covered in recommendation 1.1.4 but still of concern to the healthcare professional. • No one is able to observe the injured person at home. • Continuing concern by the injured person or their family or carer about the diagnosis. [2003, amended 2014] 	<p>Adverse social factors removed from penultimate bullet point, as the GDG considered this as inappropriate terminology.</p>
<p>1.3.2.3 Ambulance crews should be trained in the detection of non-accidental injury and should pass information to emergency department personnel when the relevant signs and symptoms arise. [2003]</p>	<p>1.2.16 Ambulance crews should be trained in the safeguarding of children and vulnerable adults and should pass information to emergency department staff when the relevant signs and symptoms arise. [2003, amended 2014]</p>	<p>The term 'non accidental injury' has been replaced with safeguarding as non-accidental injury is a child specific term and therefore appears to exclude adults.</p>

Recommendation in 2003 or 2007 guideline	Recommendation in current guideline	Reason for change
<p>1.3.2.9 Pain should be managed effectively because it can lead to a rise in intracranial pressure. Reassurance and splintage of limb fractures are helpful; catheterisation of a full bladder will reduce irritability. Analgesia as described in 1.4.1.9 should be given only under the direction of a doctor. [2007]</p>	<p>1.2.12 Manage pain effectively because it can lead to a rise in intracranial pressure. Provide reassurance and splintage of limb fractures where needed; catheterisation of a full bladder will reduce irritability. [2007, amended 2014]</p>	<p>Second sentence about analgesia removed (Analgesia as described in 1.4.1.9 should be given only under the direction of a doctor), as this is covered in the first sentence. The GDG felt that this needs to be managed under local protocols. It covers additional complexities which have not been reviewed and may be confusing to readers.</p>
<p>1.4.3.3 With modern multislice scanners the whole cervical spine can be scanned at high resolution with ease and multiplanar reformatted images generated rapidly. Facilities for multiplanar reformatting and interactive viewing should be available. [2003]</p>	<p>1.5.2 Ensure that facilities are available for multiplanar reformatting and interactive viewing of CT cervical spine scans. [2003, amended 2014]</p>	<p>First sentence removed as this is now unnecessary (imaging practice has moved on): with modern multislice scanners the whole cervical spine can be scanned at high resolution with ease and multiplanar reformatted images generated rapidly.</p>
<p>1.4.3.4 MRI is indicated in the presence of neurological signs and symptoms referable to the cervical spine and if there is suspicion of vascular injury (for example, subluxation or displacement of the spinal column, fracture through foramen transversarium or lateral processes, posterior circulation syndromes). [2003]</p>	<p>1.5.3 MR imaging is indicated scan of the cervical spine if there are neurological signs and symptoms referable to the cervical spine. If there is suspicion of vascular injury (for example, vertebral malalignment, a fracture involving the foramina transversaria or lateral processes, or a posterior circulation syndrome), CT or MRI angiography of the neck vessels may be performed to evaluate for this. [2003, amended 2014]</p>	<p>Changes based on updated terminology and current practice.</p>
<p>1.4.4.1 A clinician with expertise in non-accidental injuries in children should be involved in any suspected case of non-accidental injury in a child. Examinations/investigations that should be considered include: skull X-ray as part of a skeletal survey, ophthalmoscopic examination for retinal haemorrhage, and examination for pallor, anaemia, and tense fontanelle or other suggestive features. Other imaging such as CT and MRI may be required to define injuries. [2003, amended 2007]</p>	<p>1.3.11 A clinician with training in safeguarding should be involved in the initial assessment of any patient with a head injury presenting to the emergency department. If there are any concerns identified, follow local safeguarding procedures appropriate to the patient's age. [2003, amended 2014]</p>	<p>Updated to reflect current terminology.</p> <p>Updated for equality consideration, guideline did not previously include a recommendation for safeguarding concerns in adults (A clinician with expertise in non-accidental injuries in children should be involved in any suspected case of non-accidental injury in a child).</p> <p>Examinations/investigations</p>

Recommendation in 2003 or 2007 guideline	Recommendation in current guideline	Reason for change
		that should be considered include: skull X-ray as part of a skeletal survey, ophthalmoscopic examination for retinal haemorrhage, and examination for pallor, anaemia, and tense fontanelle or other suggestive features. Other imaging such as CT and MRI may be required to define injuries.
1.4.3.12 Children under 10 years should receive anterior/posterior and lateral plain films without an anterior/posterior peg view. [2003]	1.5.14 In children who can obey commands and open their mouths, attempt an odontoid peg view. [2003, amended 2014]	Amended based on GDG consensus as satisfactory peg views can often be obtained in those younger than 10 (essentially down to the age where they can obey the command to open their mouth nice and wide – usually about 5).
1.6.1.5 The transfer team should be provided with a means of communication with their base hospital and the neurosurgical unit during the transfer. A portable phone may be suitable providing it is not used in close proximity (that is, within 1 m) of medical equipment prone to electrical interference (for example, infusion pumps). [2003]	1.7.5 Provide the transfer team responsible for transferring a patient with a head injury with a means of communicating changes in the patient status with their base hospital and the neurosurgical unit during the transfer. [2003, amended 2014]	Reference to portable phone deleted, as this is outdated terminology. Additional text added for clarity ‘changes in the patient status’.
1.6.1.12 Carers and relatives should have as much access to the patient as is practical during transfer and be fully informed on the reasons for transfer and the transfer process. [2003]	1.7.12 Give family members and carers as much access to the patient as is practical during transfer. If possible, give them an opportunity to discuss the reasons for transfer and how the transfer process works with a member of the healthcare team. [2003, amended 2014] 1.7.17 Give family members and carers as much access to their child as is practical during transfer. If possible, give them an opportunity to discuss the reasons for transfer and how the transfer process works with a member of the healthcare team. [2003, amended 2014]	Updated based on equality consideration to allow patient discussion.

O.13.3 Changes to recommendation wording for clarification only (no change to meaning)

Recommendation numbers in current guideline	Comment
All recommendations except those labelled [new 2014]	Minor editorial changes have been made to these recommendations to reword them in the active form (where possible), in line with current NICE style for recommendations in clinical guidelines. Yellow shading has not been applied to these changes.
All recommendations	<p>'Staff' is used consistently and has replaced 'personnel' in some recommendations</p> <p>'Patient' is used consistently throughout.</p> <p>Symbols such as ≤ replaced with text.</p> <p>'Plain films' changed throughout to 'X-rays'</p> <p>'Families and carers' has been used throughout where appropriate.</p> <p>Numerals changed to digits to aid readability.</p> <p>Cross-references to other recommendations updated.</p>
1.1.2, 1.1.3, 1.1.4	Minor formatting and wording changes to convert criteria in boxes to text (including moving definitions to the 'terms used in this guideline' section).
1.2.6	Recommendation changed to bullet list to improve readability.
1.2.7	This recommendation was previously part of recommendation 1.2.6 but has been separated to improve clarity.
1.2.12, 1.3.9	<p>'Reassurance and splintage of limb fractures are helpful' has been altered to:</p> <p>'Provide reassurance and splintage of limb fractures where needed'</p> <p>in line with the direct, active style used in NICE clinical guidelines.</p>
1.2.15	'and its derived score' has been added to this recommendation to provide greater clarity.
1.6.2	The reference to NICE's patient information has been made more specific to 'Information for the public'.
1.7.2	'Multiply injured adult has been changed to 'adults with multiple injuries' in line with current NICE terminology.
1.7.6	'persistently hypotensive patient' has been changed to 'patient with persistent hypotension' in line with current NICE terminology.
1.7.15	'Multiply injured child has been changed to 'children with multiple injuries' in line with current NICE terminology.
1.8.1	<p>Minor wording and formatting changes to make this recommendation into a bullet list instead of a box.</p> <p>'Patients who have not returned to GCS15' changed to 'Patients whose GCS...'. In line with current NICE style.</p> <p>'When a patient fulfils the criteria' (bullet 3) changed to 'when a patient has indications for' in line with current NICE style.</p>

Appendix P: Reference list

- 1 Ackland HM, Cameron PA, Varma DK, Fitt GJ, Cooper DJ, Wolfe R et al. Cervical spine magnetic resonance imaging in alert, neurologically intact trauma patients with persistent midline tenderness and negative computed tomography results. *Annals of Emergency Medicine*. 2011; 58(6):521-530
- 2 Adams J, Frumiento C, Shatney-Leach L, Vane DW. Mandatory admission after isolated mild closed head injury in children: is it necessary? *Journal of Pediatric Surgery*. 2001; 36(1):119-121
- 3 Adams JM, Cockburn MI, Difazio LT, Garcia FA, Siegel BK, Bilaniuk JW. Spinal clearance in the difficult trauma patient: a role for screening MRI of the spine. *American Surgeon*. 2006; 72(1):101-105
- 4 Adalgais KM, Grossman DC, Langer SG, Mann FA. Use of helical computed tomography for imaging the pediatric cervical spine. *Academic Emergency Medicine*. 2004; 11(3):228-236
- 5 af Geijerstam JL, Britton M, Marke LA. Mild head injury: observation or computed tomography? Economic aspects by literature review and decision analysis. *Emergency Medicine Journal: EMJ*. 2004; 21(1):54-58
- 6 af Geijerstam JL, Oredsson S, Britton M. Medical outcome after immediate computed tomography or admission for observation in patients with mild head injury: randomised controlled trial. *BMJ*. 2006; 333(7566):465
- 7 af-Geijerstam JL, Britton M, Mebius C. Management of minor head injuries in emergency departments in Sweden. Time for a new strategy? *European Journal of Surgery*. 2000; 166(7):526-529
- 8 Agrawal A. CT evaluation of prognostic factors of traumatic brain injury. *Australasian Medical Journal*. 2012; 5(1):46
- 9 Ahmed N, Bialowas C, Kuo YH, Zawodniak L. Impact of preinjury anticoagulation in patients with traumatic brain injury. *Southern Medical Journal*. Department of Surgery, Division of Trauma and Surgical Critical Care, Jersey Shore University Medical Center, 1945 State Route 33, Neptune, NJ 07754, USA. nahmed@meridianhealth.com 2009; 102(5):476-480
- 10 Ahmed R, Ahamad IH, Mallikabeevi SB, Bukhari SA, Khan MA, Abubaker J. Improved outcome of severe traumatic brain Injury with protocol-based management initiated in the emergency department. *Chest*. 2010; 138(4)
- 11 Aitken ME, Mele N, Barrett KW. Recovery of injured children: parent perspectives on family needs. *Archives of Physical Medicine and Rehabilitation*. 2004; 85(4):567-573
- 12 Ajani AE, Cooper DJ, Scheinkestel CD, Laidlaw J, Tuxen DV. Optimal assessment of cervical spine trauma in critically ill patients: a prospective evaluation. *Anaesthesia and Intensive Care*. 1998; 26(5):487-491

- 13 Albrecht RM, Kingsley D, Schermer CR, Demarest GB, Benzel EC, Hart BL. Evaluation of cervical spine in intensive care patients following blunt trauma. *World Journal of Surgery*. 2001; 25(8):1089-1096
- 14 Alrajhi K, Perry JJ, Forster A. MINOR and minimal head injuries in patients on warfarin. *Canadian Journal of Emergency Medicine*. 2010; 12(3):253-254
- 15 Anglen J, Metzler M, Bunn P, Griffiths H. Flexion and extension views are not cost-effective in a cervical spine clearance protocol for obtunded trauma patients. *Journal of Trauma*. 2002; 52(1):54-59
- 16 Antevil JL, Sise MJ, Sack DI, Kidder B, Hopper A, Brown CV. Spiral computed tomography for the initial evaluation of spine trauma: A new standard of care? *Journal of Trauma*. 2006; 61(2):382-387
- 17 Arienta C, Caroli M, Balbi S. Management of head-injured patients in the emergency department: a practical protocol. *Surgical Neurology*. 1997; 48(3):213-219
- 18 Asikainen I, Kaste M, Sarna S. Predicting late outcome for patients with traumatic brain injury referred to a rehabilitation programme: a study of 508 Finnish patients 5 years or more after injury. *Brain Injury*. 1998; 12(2):95-107
- 19 Atabaki SM, Stiell IG, Bazarian JJ, Sadow KE, Vu TT, Camarca MA et al. A clinical decision rule for cranial computed tomography in minor pediatric head trauma. *Archives of Pediatrics & Adolescent Medicine*. Division of Emergency Medicine, Children's National Medical Center, George Washington University School of Medicine and Health Sciences, Washington, DC 20010-2970, USA. satabaki@cnmc.org 2008; 162(5):439-445
- 20 Avellino AM, Mann FA, Grady MS, Chapman JR, Ellenbogen RG, Alden TD et al. The misdiagnosis of acute cervical spine injuries and fractures in infants and children: the 12-year experience of a level I pediatric and adult trauma center. *Child's Nervous System*. 2005; 21(2):122-127
- 21 Bach CM, Steingruber IE, Peer S, Peer-Ku[spacing diaeresis]hberger, Jaschke W, Ogon M. Radiographic evaluation of cervical spine trauma. Plain radiography and conventional tomography versus computed tomography. *Archives of Orthopaedic and Trauma Surgery*. 2001; 121(7):385-387
- 22 Bachulis BL, Long WB, Hynes GD, Johnson MC. Clinical indications for cervical spine radiographs in the traumatized patient. *American Journal of Surgery*. 1987; 153(5):473-478
- 23 Bailitz J, Starr F, Beecroft M, Bankoff J, Roberts R, Bokhari F et al. CT should replace three-view radiographs as the initial screening test in patients at high, moderate, and low risk for blunt cervical spine injury: a prospective comparison. *Journal of Trauma*. 2009; 66(6):1605-1609
- 24 Baker C, Kadish H, Schunk JE. Evaluation of pediatric cervical spine injuries. *American Journal of Emergency Medicine*. 1999; 17(3):230-234
- 25 Bandiera G, Stiell IG, Wells GA, Clement C, De M, V, Vandemheen KL et al. The Canadian C-spine rule performs better than unstructured physician judgment. *Annals of Emergency Medicine*. 2003; 42(3):395-402

- 26 Banit DM, Grau G, Fisher JR. Evaluation of the acute cervical spine: a management algorithm. *Journal of Trauma*. 2000; 49(3):450-456
- 27 Barba CA, Taggart J, Morgan AS, Guerra J, Bernstein B, Lorenzo M et al. A new cervical spine clearance protocol using computed tomography. *Journal of Trauma*. 2001; 51(4):652-656
- 28 Barbosa RR, Jawa R, Watters JM, Knight JC, Kerwin AJ, Winston ES et al. Evaluation and management of mild traumatic brain injury: an Eastern Association for the Surgery of Trauma practice management guideline. *Journal of Trauma and Acute Care Surgery*. 2012; 73(5 Suppl 4):S307-S314
- 29 Barnett AS, Wang NE, Sahni R, Hsia RY, Haukoos JS, Barton ED et al. Variation in prehospital use and uptake of the national Field Triage Decision Scheme. *Prehospital Emergency Care*. 2013; 17(2):135-148
- 30 Barth JT, Macciocchi SN, Giordani B, Rimel R, Jane JA, Boll TJ. Neuropsychological sequelae of minor head injury. *Neurosurgery*. 1983; 13(5):529-533
- 31 Batchelor JS, Grayson A. A meta-analysis to determine the effect of anticoagulation on mortality in patients with blunt head trauma. *British Journal of Neurosurgery*. 2012; 26(4):525-530
- 32 Batchelor JS, Grayson A. A meta-analysis to determine the effect of preinjury antiplatelet agents on mortality in patients with blunt head trauma. *British Journal of Neurosurgery*. 2013; 27(1):12-18
- 33 Bayless P, Ray VG. Incidence of cervical spine injuries in association with blunt head trauma. *American Journal of Emergency Medicine*. 1989; 7(2):139-142
- 34 Bazarian J, Hartman M, Delahunta E. Minor head injury: predicting follow-up after discharge from the Emergency Department. *Brain Injury*. 2000; 14(3):285-294
- 35 Bazarian JJ, Atabaki S. Predicting postconcussion syndrome after minor traumatic brain injury. *Academic Emergency Medicine*. 2001; 8(8):788-795
- 36 Bazarian JJ, Wong T, Harris M, Leahey N, Mookerjee S, Dombovy M. Epidemiology and predictors of post-concussive syndrome after minor head injury in an emergency population. *Brain Injury*. 1999; 13(3):173-189
- 37 Beaudin M, Saint-Vil D, Ouimet A, Mercier C, Crevier L. Clinical algorithm and resource use in the management of children with minor head trauma. *Journal of Pediatric Surgery*. 2007; 42(5):849-852
- 38 Bechtel K, Frasure S, Marshall C, Dziura J, Simpson C. Relationship of serum S100B levels and intracranial injury in children with closed head trauma. *Pediatrics*. 2009; 124(4):e697-e704
- 39 Benito-Fernandez J, Mintegui-Raso S, Sanchez-Echaniz J, Martinez-Gonzalez MJ, Fernandez-Cuesta MA. Head injuries in children: can clinical features identify patients with high or low risk for intracranial injury? *Anales Espanoles De Pediatria*. 1998; 48(2):122-126
- 40 Benzel EC, Hart BL, Ball PA, Baldwin NG, Orrison WW, Espinosa MC. Magnetic resonance imaging for the evaluation of patients with occult cervical spine injury. *Journal of Neurosurgery*. 1996; 85(5):824-829

- 41 Berne JD, Velmahos GC, El Tawil Q, Demetriades D, Asensio JA, Murray JA et al. Value of complete cervical helical computed tomographic scanning in identifying cervical spine injury in the unevaluable blunt trauma patient with multiple injuries: a prospective study. *Journal of Trauma*. 1999; 47(5):896-902
- 42 Bernstein DM. Recovery from mild head injury. *Brain Injury : [BI]*. 1999; 13(3):151-172
- 43 Biberthaler P, Linsenmeier U, Pfeifer KJ, Kroetz M, Mussack T, Kanz KG et al. Serum S-100B concentration provides additional information for the indication of computed tomography in patients after minor head injury: a prospective multicenter study. *Shock*. 2006; 25(5):446-453
- 44 Biberthaler P, Mussack T, Wiedemann E, Kanz KG, Koelsch M, Gippner-Steppert C et al. Evaluation of S-100b as a specific marker for neuronal damage due to minor head trauma. *World Journal of Surgery*. 2001; 25(1):93-97
- 45 Biberthaler P, Mussack T, Wiedemann E, Kanz KG, Mutschler W, Linsenmaier U et al. Rapid identification of high-risk patients after minor head trauma (MHT) by assessment of S-100B: ascertainment of a cut-off level. *European Journal of Medical Research*. 2002; 7(4):164-170
- 46 Bin SS, Schutzman SA, Greenes DS. Validation of a clinical score to predict skull fracture in head-injured infants. *Pediatric Emergency Care*. Department of Emergency Medicine, Mary Bridge Children's Hospital, 315 Martin Luther King Jr. Way, Tacoma, WA 98405, USA. Steven.Bin@Multicare.org 2010; 26(9):633-639
- 47 Blackmore CC. Evidence-based imaging evaluation of the cervical spine in trauma. *Neuroimaging Clinics of North America*. 2003; 13(2):283-291
- 48 Blackmore CC, Deyo RA. Specificity of cervical spine radiography: Importance of clinical scenario. *Emergency Radiology*. 1997; 4(5):283-286
- 49 Blackmore CC, Ramsey SD, Mann FA, Deyo RA. Cervical spine screening with CT in trauma patients: a cost-effectiveness analysis (Structured abstract). *Radiology*. 1999; 212(1):117-125
- 50 Blakely TA, Jr., Harrington DE. Mild head injury is not always mild; implications for damage litigation. *Medicine, Science and the Law*. 1993; 33(3):231-242
- 51 Blostein PA, Jones SJ, Buechler CM, Vandongen S. Cognitive screening in mild traumatic brain injuries: analysis of the neurobehavioral cognitive status examination when utilized during initial trauma hospitalization. *Journal of Neurotrauma*. 1997; 14(3):171-177
- 52 Borczuk P. Predictors of intracranial injury in patients with mild head trauma. *Annals of Emergency Medicine*. 1995; 25(6):731-736
- 53 Borock EC, Gabram SG, Jacobs LM, Murphy MA. A prospective analysis of a two-year experience using computed tomography as an adjunct for cervical spine clearance. *Journal of Trauma*. 1991; 31(7):1001-1005
- 54 Bouida W, Marghli S, Souissi S, Ksibi H, Methammem M, Haguiga H et al. Prediction Value of the Canadian CT Head Rule and the New Orleans Criteria for Positive Head CT Scan and Acute Neurosurgical Procedures in Minor Head Trauma: A Multicenter External Validation Study. *Annals of Emergency Medicine*. 2013; 61(5):521-527

- 55 Bouvier D, Fournier M, Dauphin JB, Amat F, Ughetto S, Labbe A et al. Serum S100B determination in the management of pediatric mild traumatic brain injury. *Clinical Chemistry*. 2012; 58(7):1116-1122
- 56 Brady WJ, Moghtader J, Cutcher D, Exline C, Young J. ED use of flexion-extension cervical spine radiography in the evaluation of blunt trauma. *American Journal of Emergency Medicine*. 1999; 17(6):504-508
- 57 Brehaut JC, Graham ID, Wood TJ, Taljaard M, Eagles D, Lott A et al. Measuring acceptability of clinical decision rules: validation of the Ottawa acceptability of decision rules instrument (OADRI) in four countries. *Medical Decision Making*. 2010; 30(3):398-408
- 58 Brehaut JC, Stiell IG, Graham ID. Will a new clinical decision rule be widely used? The case of the Canadian C-spine rule. *Academic Emergency Medicine*. 2006; 13(4):413-420
- 59 Brewer ES, Reznikov B, Liberman RF, Baker RA, Rosenblatt MS, David CA et al. Incidence and predictors of intracranial hemorrhage after minor head trauma in patients taking anticoagulant and antiplatelet medication. *Journal of Trauma*. 2011; 70(1):E1-E5
- 60 Briggs M, Clarke P, Crockard A, Cummins B, Galbraith S, Garfield J et al. Guidelines for initial management after head injury in adults. Suggestions from a group of neurosurgeons. *BMJ*. 1984; 288(6422):983-985
- 61 Brillhart J. Which patients with blunt trauma do not require cervical spine x-rays? *Journal of Family Practice*. 2000; 49(10):884-885
- 62 Brohi K, Healy M, Fotheringham T, Chan O, Aylwin C, Whitley S et al. Helical computed tomographic scanning for the evaluation of the cervical spine in the unconscious, intubated trauma patient. *Journal of Trauma*. 2005; 58(5):897-901
- 63 Brookes M, MacMillan R, Cully S, Anderson E, Murray S, Mendelow AD et al. Head injuries in accident and emergency departments. How different are children from adults? *Journal of Epidemiology and Community Health*. 1990; 44(2):147-151
- 64 Brookes M, Mendelow AD, MacMillan R. Which head injured patients have a skull fracture? First International Conference on Emergency Medicine. London, England, 14-18 April 1986. *Archives of Emergency Medicine*. 1986; 3(1):41-42
- 65 Brooks RA, Willett KM. Evaluation of the Oxford protocol for total spinal clearance in the unconscious trauma patient. *Journal of Trauma*. 2001; 50(5):862-867
- 66 Brown AJ, Witham MD, George J. Development of a risk score to guide brain imaging in older patients admitted with falls and confusion. *British Journal of Radiology*. 2011; 84(1004):756-757
- 67 Buchanich JM. A clinical decision-making rule for mild head injury in children less than three years old University of Pittsburgh Pittsburgh, PA; 2007.
- 68 Calcagnile O, Uden L, Uden J. Clinical validation of S100B use in management of mild head injury. *BMC Emergency Medicine*. 2012; 12
- 69 Campbell KA, Berger RP, Ettaro L, Roberts MS. Cost-effectiveness of head computed tomography in infants with possible inflicted traumatic brain injury. *Pediatrics*. 2007; 120(2):295-304

- 70 Carroll LJ, Cassidy JD, Peloso PM, Borg J, von Holst H, Holm L et al. Prognosis for mild traumatic brain injury: Results of the WHO Collaborating Centre Task Force on Mild Traumatic Brain Injury. *Journal of Rehabilitation Medicine*. 2004; 43 Suppl:84-105
- 71 Castellani C, Bimbashi P, Rutenstock E, Sacherer P, Stojakovic T, Weinberg AM. Neuroprotein s-100B -- a useful parameter in paediatric patients with mild traumatic brain injury? *Acta Paediatrica*. Department of Pediatric Surgery, Medical University Graz, Graz, Austria. christoph.castellani@meduni-graz.at 2009; 98(10):1607-1612
- 72 Cattelani R, Gugliotta M, Maravita A, Mazzucchi A. Post-concussive syndrome: paraclinical signs, subjective symptoms, cognitive functions and MMPI profiles. *Brain Injury*. 1996; 10(3):187-195
- 73 Cervellin G, Benatti M, Carbuicchio A, Mattei L, Cerasti D, Aloe R et al. Serum levels of protein S100B predict intracranial lesions in mild head injury. *Clinical Biochemistry*. 2012; 45(6):408-411
- 74 Chan KH, Mann KS, Yue CP, Fan YW, Cheung M. The significance of skull fracture in acute traumatic intracranial hematomas in adolescents: a prospective study. *Journal of Neurosurgery*. 1990; 72(2):189-194
- 75 Chan KH, Yue CP, Mann KS. The risk of intracranial complications in pediatric head injury. Results of multivariate analysis. *Childs Nervous System*. 1990; 6(1):27-29
- 76 Cheung R, Ardolino A, Lawrence T, Bouamra O, Lecky F, Berry K et al. The accuracy of existing prehospital triage tools for injured children in England: an analysis using trauma registry data. *Emergency Medicine Journal*. 2012;
- 77 Ciccarese E, Milletti S, Venturoli L. Minor head injury in adults. Results of the application of a guideline. *Radiologia Medica*. 1998; 96(5):480-484
- 78 Ciesla DJ, Tepas JJ, Pracht EE, Langland-Orban B, Cha JY, Flint LM. Fifteen-year trauma system performance analysis demonstrates optimal coverage for most severely injured patients and identifies a vulnerable population. *Journal of the American College of Surgeons*. 2013; 216(4):687-688
- 79 Cigada M, Figini S, Guatteri L, Zaniboni M, Gavazzi A, Iapichino G. Minor head injury: Effects of diagnostic and therapeutic guidelines. *Chirurgia*. 1999; 12(6):405-407
- 80 Clancy MJ. Clearing the cervical spine of adult victims of trauma. *Journal of Accident and Emergency Medicine*. 1999; 16(3):208-214
- 81 Claudia C, Claudia R, Agostino O, Simone M, Stefano G. Minor head injury in warfarinized patients: Indicators of risk for intracranial hemorrhage. *Journal of Trauma - Injury, Infection and Critical Care*. 2011; 70(4):906-909
- 82 Coffey F, Hewitt S, Stiell I, Howarth N, Miller P, Clement C et al. Validation of the Canadian c-spine rule in the UK emergency department setting. *Emergency Medicine Journal*. 2011; 28(10):873-876
- 83 Cohen DB, Rinker C, Wilberger JE. Traumatic brain injury in anticoagulated patients. *Journal of Trauma-Injury Infection & Critical Care*. Department of Neurosurgery, Allegheny General Hospital, Pittsburgh, Pennsylvania 15212, USA. 2006; 60(3):553-557

- 84 Cohn SM, Lyle WG, Linden CH, Lancey RA. Exclusion of cervical spine injury: a prospective study. *Journal of Trauma*. 1991; 31(4):570-574
- 85 Como JJ, Thompson MA, Anderson JS, Shah RR, Claridge JA, Yowler CJ et al. Is magnetic resonance imaging essential in clearing the cervical spine in obtunded patients with blunt trauma? *Journal of Trauma-Injury Infection & Critical Care*. Department of Surgery, Division of Neurosurgery, MetroHealth Medical Center, Case School of Medicine, Cleveland, Ohio 44109, USA. jcomo@metrohealth.org 2007; 63(3):544-549
- 86 Como JJ, Leukhardt WH, Anderson JS, Wilczewski PA, Samia H, Claridge JA. Computed tomography alone may clear the cervical spine in obtunded blunt trauma patients: a prospective evaluation of a revised protocol. *Journal of Trauma*. 2011; 70(2):345-351
- 87 Cooper DJ, Ackland HM. Clearing the cervical spine in unconscious head injured patients - the evidence. *Critical Care and Resuscitation*. 2005; 7(3):181-184
- 88 Cox S, Currell A, Harriss L, Barger B, Cameron P, Smith K. Evaluation of the Victorian state adult pre-hospital trauma triage criteria. *Injury*. 2012; 43(5):573-581
- 89 Cox S, Smith K, Currell A, Harriss L, Barger B, Cameron P. Differentiation of confirmed major trauma patients and potential major trauma patients using pre-hospital trauma triage criteria. *Injury*. 2011; 42(9):889-895
- 90 Crim JR, Moore K, Brodke D. Clearance of the cervical spine in multitrauma patients: the role of advanced imaging. *Seminars in Ultrasound, CT and MR*. 2001; 22(4):283-305
- 91 Cudnik MT, Werman HA, White LJ, Opalek JM. Prospective validation of clinical decision rule for helicopter transport of injured patients. *Academic Emergency Medicine*. 2012; 19:S285
- 92 Culotta VP, Sementilli ME, Gerold K, Watts CC. Clinicopathological heterogeneity in the classification of mild head injury. *Neurosurgery*. 1996; 38(2):245-250
- 93 Cummins BH. The management of head injuries. *Current Orthopaedics*. 1992; 6(4):240-244
- 94 D'Alise MD, Benzel EC, Hart BL. Magnetic resonance imaging evaluation of the cervical spine in the comatose or obtunded trauma patient. *Journal of Neurosurgery*. 1999; 91(1 Suppl):54-59
- 95 Da Dalt L, Marchi AG, Laudizi L, Crichiutti G, Messi G, Pavanello L et al. Predictors of intracranial injuries in children after blunt head trauma. *European Journal of Pediatrics*. 2006; 165(3):142-148
- 96 Dare AO, Dias MS, Li V. Magnetic resonance imaging correlation in pediatric spinal cord injury without radiographic abnormality. *Journal of Neurosurgery*. 2002; 97(1 Suppl):33-39
- 97 Davis JW, Kaups KL, Cunningham MA, Parks SN, Nowak TP, Bilello JF et al. Routine evaluation of the cervical spine in head-injured patients with dynamic fluoroscopy: a reappraisal. *Journal of Trauma*. 2001; 50(6):1044-1047
- 98 Davis JW, Parks SN, Detlefs CL, Williams GG, Williams JL, Smith RW. Clearing the cervical spine in obtunded patients: the use of dynamic fluoroscopy. *Journal of Trauma*. 1995; 39(3):435-438
- 99 Davis JW, Phreaner DL, Hoyt DB, Mackersie RC. The etiology of missed cervical spine injuries. *Journal of Trauma*. 1993; 34(3):342-346

- 100 Davis RL, Hughes M, Gubler KD, Waller PL, Rivara FP. The use of cranial CT scans in the triage of pediatric patients with mild head injury. *Pediatrics*. 1995; 95(3):345-349
- 101 Davis RL, Mullen N, Makela M, Taylor JA, Cohen W, Rivara FP. Cranial computed tomography scans in children after minimal head injury with loss of consciousness. *Annals of Emergency Medicine*. 1994; 24(4):640-645
- 102 Deb S, Lyons I, Koutzoukis C. Neuropsychiatric sequelae one year after a minor head injury. *Journal of Neurology, Neurosurgery and Psychiatry*. 1998; 65(6):899-902
- 103 Dehdari A, Sutherland J. Impact of implementing Canadian CT head rules on number of CT head studies in emergency department. *Journal of Medical Imaging and Radiation Oncology*. 2010; 54:A97
- 104 Department of Health. NHS reference costs 2009-2010. 2011. [Last accessed: 1 August 2011]
- 105 Department of Health. NHS reference costs 2011-12. 2012. Available from: <https://www.gov.uk/government/publications/nhs-reference-costs-financial-year-2011-to-2012> [Last accessed: 10 July 2012]
- 106 Diaz JJ, Jr., Gillman C, Morris JA, Jr., May AK, Carrillo YM, Guy J. Are five-view plain films of the cervical spine unreliable? A prospective evaluation in blunt trauma patients with altered mental status. *Journal of Trauma*. 2003; 55(4):658-663
- 107 Dickinson G, Stiell IG, Schull M, Brison R, Clement CM, Vandemheen KL et al. Retrospective application of the NEXUS low-risk criteria for cervical spine radiography in Canadian emergency departments. *Annals of Emergency Medicine*. 2004; 43(4):507-514
- 108 Dietrich AM, Bowman MJ, Ginn-Pease ME, Kosnik E, King DR. Pediatric head injuries: can clinical factors reliably predict an abnormality on computed tomography? *Annals of Emergency Medicine*. 1993; 22(10):1535-1540
- 109 Dietrich AM, Ginn-Pease ME, Bartkowski HM, King DR. Pediatric cervical spine fractures: predominantly subtle presentation. *Journal of Pediatric Surgery*. 1991; 26(8):995-999
- 110 Dikmen S, Machamer J, Fann JR, Temkin NR. Rates of symptom reporting following traumatic brain injury. *Journal of the International Neuropsychological Society : JINS*. 2010; 16(3):401-411
- 111 Dinh .M.M., Oliver M, Bein KJ, Roncal S, Byrne CM. Performance of the New South Wales Ambulance Service major trauma transport protocol (T1) at an inner city trauma centre. *Emergency Medicine Australasia*. 2012; 24(4):401-407
- 112 DiRusso SM, Sullivan T, Risucci D, Nealon P, Slim M. Intubation of pediatric trauma patients in the field: predictor of negative outcome despite risk stratification. *Journal of Trauma*. 2005; 59(1):84-90
- 113 Domeier RM, Swor RA, Evans RW, Hancock JB, Fales W, Krohmer J et al. Multicenter prospective validation of prehospital clinical spinal clearance criteria. *Journal of Trauma*. 2002; 53(4):744-750
- 114 Duane TM, Dechert T, Wolfe LG, Aboutanos MB, Malhotra AK, Ivatury RR. Clinical examination and its reliability in identifying cervical spine fractures. *Journal of Trauma*. 2007; 62(6):1405-1410

- 115 Duane TM, Wilson SP, Mayglothling J, Wolfe LG, Aboutanos MB, Whelan JF et al. Canadian Cervical Spine rule compared with computed tomography: a prospective analysis. *Journal of Trauma*. 2011; 71(2):352-357
- 116 Dunham CM, Coates S, Cooper C. Compelling evidence for discretionary brain computed tomographic imaging in those patients with mild cognitive impairment after blunt trauma. *Journal of Trauma*. 1996; 41(4):679-686
- 117 Dunning J. A multicentre study to develop a set of clinical decision rules for the management of head injury in children. Incorporating the CHALICE study: children's head injury algorithm to predict important clinical events University of Manchester; 2006.
- 118 Dunning J, Daly JP, Lomas JP, Lecky F, Batchelor J, Mackway-Jones K. Derivation of the children's head injury algorithm for the prediction of important clinical events decision rule for head injury in children. *Archives of Disease in Childhood*. 2006; 91(11):885-891
- 119 Dunning J, Daly JP, Malhotra R, Stratford-Smith P, Lomas JP, Lecky F et al. The implications of NICE guidelines on the management of children presenting with head injury. *Archives of Disease in Childhood*. 2004; 89(8):763-767
- 120 Duus BR, Boesen T, Kruse KV, Nielsen KB. Prognostic signs in the evaluation of patients with minor head injury. *British Journal of Surgery*. 1993; 80(8):988-991
- 121 Duus BR, Lind B, Christensen H, Nielsen OA. The role of neuroimaging in the initial management of patients with minor head injury. *Annals of Emergency Medicine*. 1994; 23(6):1279-1283
- 122 Dwek JR, Chung CB. Radiography of cervical spine injury in children: are flexion-extension radiographs useful for acute trauma? *AJR American Journal of Roentgenology*. 2000; 174(6):1617-1619
- 123 Edwards MJ, Frankema SP, Kruit MC, Bode PJ, Breslau PJ, van Vugt AB. Routine cervical spine radiography for trauma victims: Does everybody need it? *Journal of Trauma*. 2001; 50(3):529-534
- 124 Egea-Guerrero JJ, Munoz-Sanchez MA, Murillo-Cabezas F, Vilches-Arenas A, Sanchez-Linares P, Dominguez-Roldan JM et al. S100 b protein: How is it accuracy to detect brain damage after a head trauma? *Intensive Care Medicine*. 2010; 36:S417
- 125 Egea-Guerrero JJ, Revuelto-Rey J, Murillo-Cabezas F, Munoz-Sanchez MA, Vilches-Arenas A, Sanchez-Linares P et al. Accuracy of the S100beta protein as a marker of brain damage in traumatic brain injury. *Brain Injury*. 2012; 26(1):76-82
- 126 Ehrlich PF, Wee C, Drongowski R, Rana AR. Canadian C-spine Rule and the National Emergency X-Radiography Utilization Low-Risk Criteria for C-spine radiography in young trauma patients. *Journal of Pediatric Surgery*. 2009; 44(5):987-991
- 127 Emery SE, Pathria MN, Wilber RG, Masaryk T, Bohlman HH. Magnetic resonance imaging of posttraumatic spinal ligament injury. *Journal of Spinal Disorders*. 1989; 2(4):229-233
- 128 Engel KG, Buckley BA, Forth VE, McCarthy DM, Ellison EP, Schmidt MJ et al. Patient understanding of emergency department discharge instructions: where are knowledge deficits greatest? *Academic Emergency Medicine*. 2012; 19(9):E1035-E1044

- 129 Ersoy G, Karcioğlu O, Enginbaş Y, Eray O, Ayrik C. Are cervical spine X-rays mandatory in all blunt trauma patients? *European Journal of Emergency Medicine*. 1995; 2(4):191-195
- 130 Eubanks JD, Gilmore A, Bess S, Cooperman DR. Clearing the pediatric cervical spine following injury. *Journal of the American Academy of Orthopaedic Surgeons*. 2006; 14(9):552-564
- 131 Fabbri A, Servadei F, Marchesini G, Bronzoni C, Montesi D, Arietta L. Antiplatelet therapy and the outcome of subjects with intracranial injury: the Italian SIMEU study. *Critical Care (London, England)*. 2013; 17(2):R53
- 132 Fabbri A, Servadei F, Marchesini G, Dente M, Iervese T, Spada M et al. Clinical performance of NICE recommendations versus NCWFNS proposal in patients with mild head injury. *Journal of Neurotrauma*. 2005; 22(12):1419-1427
- 133 Fabbri A, Servadei F, Marchesini G, Morselli-Labate AM, Dente M, Iervese T et al. Prospective validation of a proposal for diagnosis and management of patients attending the emergency department for mild head injury. *Journal of Neurology, Neurosurgery and Psychiatry*. 2004; 75(3):410-416
- 134 Fabbri A, Servadei F, Marchesini G, Stein SC, Vandelli A. Early predictors of unfavourable outcome in subjects with moderate head injury in the emergency department. *Journal of Neurology, Neurosurgery & Psychiatry*. Dipartimento dell'Emergenza, Presidio Ospedaliero Morgagni-Pierantoni, Azienda USL Forlì, Via Forlanini 34, I-47100 Forlì, Italy. andrea.fabbri@formulatre.it 2008; 79(5):567-573
- 135 Fabbri A, Servadei F, Marchesini G, Stein SC, Vandelli A. Observational approach to subjects with mild-to-moderate head injury and initial non-neurosurgical lesions. *Journal of Neurology, Neurosurgery, and Psychiatry*. 2008; 79(10):1180-1185
- 136 Fabbri A, Vandelli A, Servadei F, Marchesini G. Coagulopathy and NICE recommendations for patients with mild head injury. *Journal of Neurology, Neurosurgery, and Psychiatry*. 2004; 75(12):1787-1788
- 137 Fabbri A, Servadei F, Marchesini G, Raggi A, Vandelli A. Analysis of different decision aids for clinical use in pediatric head injury in an emergency department of a general hospital. *Journal of Trauma*. 2011; 70(5):E79-E83
- 138 Fabbri A, Servadei F, Marchesini G, Stein SC, Vandelli A. Predicting intracranial lesions by antiplatelet agents in subjects with mild head injury. *Journal of Neurology, Neurosurgery, and Psychiatry*. 2010; 81(11):1275-1279
- 139 Falk AC, von Wendt L, Klang B. Informational needs in families after their child's mild head injury. *Patient Education and Counseling*. 2008; 70(2):251-255
- 140 Falk AC, von Wendt L, Soderkvist BK. Families' perceptions of given information in relation to their child's head injury. *Scandinavian Journal of Caring Sciences*. 2009; 23(1):125-129
- 141 Fehlings MG, Cadotte DW, Fehlings LN. A series of systematic reviews on the treatment of acute spinal cord injury: a foundation for best medical practice. *Journal of Neurotrauma*. 2011; 28(8):1329-1333

- 142 Filippidis AS, Papadopoulos DC, Kapsalaki EZ, Fountas KN. Role of the S100B serum biomarker in the treatment of children suffering from mild traumatic brain injury. [Review]. *Neurosurgical Focus. Department of Neurosurgery, University Hospital of Larissa, School of Medicine, University of Thessaly, Greece* 2010; 29(5):E2
- 143 Finizio FS, Galassi E. Extradural hematomas in childhood and adolescence. *Riv Neuroradiol.* 1992; 5(SUPPL. 1):45-50
- 144 Fischer RP. Cervical radiographic evaluation of alert patients following blunt trauma. *Annals of Emergency Medicine.* 1984; 13(10):905-907
- 145 Fiser SM, Johnson SB, Fortune JB. Resource utilization in traumatic brain injury: the role of magnetic resonance imaging. *American Surgeon.* 1998; 64(11):1088-1093
- 146 Forsyth R. The CHALICE rule: ready for prime time? *Archives of Disease in Childhood.* 2006; 91(11):877-878
- 147 Fortuna GR, Mueller EW, James LE, Shutter LA, Butler KL. The impact of preinjury antiplatelet and anticoagulant pharmacotherapy on outcomes in elderly patients with hemorrhagic brain injury. *Surgery. Department of Surgery, Division of Pharmacy Practice, The University Hospital, University of Cincinnati, Cincinnati, Ohio, USA.* 2008; 144(4):598-603
- 148 Frank JB, Lim CK, Flynn JM, Dormans JP. The efficacy of magnetic resonance imaging in pediatric cervical spine clearance. *Spine.* 2002; 27(11):1176-1179
- 149 Franko J, Kish KJ, O'Connell BG, Subramanian S, Yuschak JV. Advanced age and preinjury warfarin anticoagulation increase the risk of mortality after head trauma. *Journal of Trauma.* 2006; 61(1):107-110
- 150 Freedman I, van Gelderen D, Cooper DJ, Fitzgerald M, Malham G, Rosenfeld JV et al. Cervical spine assessment in the unconscious trauma patient: a major trauma service's experience with passive flexion-extension radiography. *Journal of Trauma.* 2005; 58(6):1183-1188
- 151 Freemyer B, Knopp R, Piche J, Wales L, Williams J. Comparison of five-view and three-view cervical spine series in the evaluation of patients with cervical trauma. *Annals of Emergency Medicine.* 1989; 18(8):818-821
- 152 Fridriksson T, Kini N, Walsh-Kelly C, Hennes H. Serum neuron-specific enolase as a predictor of intracranial lesions in children with head trauma: a pilot study. *Academic Emergency Medicine.* 2000; 7(7):816-820
- 153 Friedemann-Sanchez G, Griffin JM, Rettmann NA, Rittman M, Partin MR. Communicating information to families of polytrauma patients: a narrative literature review. *Rehabilitation Nursing.* 2008; 33(5):206-213
- 154 Frush DP, O'Hara SM, Kliewer MA. Pediatric imaging perspective: Acute head trauma - Is skull radiography useful? *Journal of Pediatrics.* 1998; 132(3 pt 1):553-554
- 155 Fuller G, Lecky F, Batchelor J, Dunning J. An external validation of the PECARN clinical decision rule for minor head injury. *Emergency Medicine Journal.* 2011; 28:A2

- 156 Gagnon I, Swaine B, Champagne F, Lefebvre H. Perspectives of adolescents and their parents regarding service needs following a mild traumatic brain injury. *Brain Injury*. 2008; 22(2):161-173
- 157 Gale SC, Gracias VH, Reilly PM, Schwab CW. The inefficiency of plain radiography to evaluate the cervical spine after blunt trauma. *Journal of Trauma*. 2005; 59(5):1121-1125
- 158 Garner A, Lee A, Harrison K, Schultz CH. Comparative analysis of multiple-casualty incident triage algorithms. *Annals of Emergency Medicine*. 2001; 38(5):541-548
- 159 Garra G, Nashed AH, Capobianco L. Minor head trauma in anticoagulated patients. *Academic Emergency Medicine*. 1999; 6(2):121-124
- 160 Garton HJ, Hammer MR. Detection of pediatric cervical spine injury. *Neurosurgery*. Department of Neurosurgery, University of Michigan Health System, Ann Arbor, Michigan 48109-0338, USA. hgarton@umich.edu 2008; 62(3):700-708
- 161 Gerrelts BD, Petersen EU, Mabry J, Petersen SR. Delayed diagnosis of cervical spine injuries. *Journal of Trauma*. 1991; 31(12):1622-1626
- 162 Ghanta MK, Smith LM, Polin RS, Marr AB, Spires WV. An analysis of Eastern Association for the Surgery of Trauma practice guidelines for cervical spine evaluation in a series of patients with multiple imaging techniques. *American Surgeon*. 2002; 68(6):563-568
- 163 Ghen MJ, Corso NA. Protocol for diagnosis of the traumatized cervical spine. *J Neurol Orthop Med Surg*. 1992; 13(1):65-67
- 164 Gittleman AM, Ortiz AO, Keating DP, Katz DS. Indications for CT in patients receiving anticoagulation after head trauma. *Ajnr: American Journal of Neuroradiology*. Department of Radiology, Winthrop-University Hospital, Mineola, NY 11501, USA. 2005; 26(3):603-606
- 165 Gomez PA, Lobato RD, Ortega JM, De La CJ. Mild head injury: differences in prognosis among patients with a Glasgow Coma Scale score of 13 to 15 and analysis of factors associated with abnormal CT findings. *British Journal of Neurosurgery*. 1996; 10(5):453-460
- 166 Gonzalez RP, Cummings GR, Phelan HA, Bosarge PL, Rodning CB. Clinical examination in complement with computed tomography scan: An effective method for identification of cervical spine injury. *Journal of Trauma - Injury, Infection and Critical Care*. 2009; 67(6):1297-1304
- 167 Gonzalez RP, Fried PO, Bukhalo M, Holevar MR, Falimirski ME. Role of clinical examination in screening for blunt cervical spine injury. *Journal of the American College of Surgeons*. 1999; 189(2):152-157
- 168 Goodnight TJ, Helmer SD, Dort JM, Nold RJ, Smith RS. A comparison of flexion and extension radiographs with computed tomography of the cervical spine in blunt trauma. *American Surgeon*. 2008; 74(9):855-857
- 169 Gradisek P, Osredkar J, Kremzar B, Korsic M. Biochemical markers of traumatic brain injury. *Zdravniški Vestnik*. 2011; 80(4):293-301
- 170 Grandhi R, Duane TM, Dechert T, Malhotra AK, Aboutanos MB, Wolfe LG et al. Anticoagulation and the elderly head trauma patient. *American Surgeon*. Virginia Commonwealth University Medical Center, Richmond, Virginia, USA. 2008; 74(9):802-805

- 171 Greenes DS, Schutzman SA. Clinical indicators of intracranial injury in head-injured infants. *Pediatrics*. 1999; 104(4 Pt 1):861-867
- 172 Greenes DS, Schutzman SA. Clinical significance of scalp abnormalities in asymptomatic head-injured infants. *Pediatric Emergency Care*. 2001; 17(2):88-92
- 173 Griffen MM, Frykberg ER, Kerwin AJ, Schinco MA, Tepas JJ, Rowe K et al. Radiographic clearance of blunt cervical spine injury: plain radiograph or computed tomography scan? *Journal of Trauma*. 2003; 55(2):222-226
- 174 Griffith B, Bolton C, Goyal N, Brown ML, Jain R. Screening cervical spine CT in a level I trauma center: overutilization? *American Journal of Roentgenology*. 2011; 197(2):463-467
- 175 Grogan EL, Morris JA, Jr., Dittus RS, Moore DE, Poulouse BK, Diaz JJ et al. Cervical spine evaluation in urban trauma centers: lowering institutional costs and complications through helical CT scan. *Journal of the American College of Surgeons*. 2005; 200(2):160-165
- 176 Gruskin KD, Schutzman SA. Head trauma in children younger than 2 years: are there predictors for complications? *Archives of Pediatrics and Adolescent Medicine*. 1999; 153(1):15-20
- 177 Gutman MB, Moulton RJ, Sullivan I, Hotz G, Tucker WS, Muller PJ. Risk factors predicting operable intracranial hematomas in head injury. *Journal of Neurosurgery*. 1992; 77(1):9-14
- 178 Guzel A, Hicdonmez T, Temizoz O, Aksu B, Aylanc H, Karasalihoglu S. Indications for brain computed tomography and hospital admission in pediatric patients with minor head injury: how much can we rely upon clinical findings? *Pediatric Neurosurgery*. 2009; 45(4):262-270
- 179 Haboubi NH, Long J, Koshy M, Ward AB. Short-term sequelae of minor head injury (6 years experience of minor head injury clinic). *Disability and Rehabilitation*. 2001; 23(14):635-638
- 180 Hahn YS, McLone DG. Risk factors in the outcome of children with minor head injury. *Pediatric Neurosurgery*. 1993; 19(3):135-142
- 181 Hallen M, Karlsson M, Carlhed R, Hallgren T, Bergenheim M. S-100B in serum and urine after traumatic head injury in children. *Journal of Trauma-Injury Infection & Critical Care. Department of Surgery, Central Hospital, Karlstad, Sweden*. 2010; 69(2):284-289
- 182 Halley MK, Silva PD, Foley J, Rodarte A. Loss of consciousness: when to perform computed tomography? *Pediatric Critical Care Medicine*. 2004; 5(3):230-233
- 183 Halpern CH, Milby AH, Guo W, Schuster JM, Gracias VH, Stein SC. Clearance of the cervical spine in clinically unevaluable trauma patients. *Spine*. 2010; 35(18):1721-1728
- 184 Hannan EL, Farrell LS, Cooper A, Henry M, Simon B, Simon R. Physiologic trauma triage criteria in adult trauma patients: are they effective in saving lives by transporting patients to trauma centers? *Journal of the American College of Surgeons*. 2005; 200(4):584-592
- 185 Hanson JA, Blackmore CC, Mann FA, Wilson AJ. Cervical spine injury: a clinical decision rule to identify high-risk patients for helical CT screening. *American Journal of Roentgenology*. 2000; 174(3):713-717

- 186 Harad FT, Kerstein MD. Inadequacy of bedside clinical indicators in identifying significant intracranial injury in trauma patients. *Journal of Trauma*. 1992; 32(3):359-361
- 187 Harris JH, Jr. What is the minimum number of plain radiographs necessary to evaluate the cervical spine in patients who have had trauma? *AJR American Journal of Roentgenology*. 1994; 163(1):217-218
- 188 Harris MB, Kronlage SC, Carboni PA, Robert KQ, Menmuir B, Ricciardi JE et al. Evaluation of the cervical spine in the polytrauma patient. *Spine*. 2000; 25(22):2884-2891
- 189 Hartl R, Gerber LM, Iacono L, Ni Q, Lyons K, Ghajar J. Direct transport within an organized state trauma system reduces mortality in patients with severe traumatic brain injury. *Journal of Trauma*. 2006; 60(6):1250-1256
- 190 Härtl R, Gerber LM, Iacono L, Ni Q, Lyons K, Ghajar J. Direct transport within an organized state trauma system reduces mortality in patients with severe traumatic brain injury. *Journal of Trauma*. 2006; 60(6):1250-1256
- 191 Hassan N, Turner SL, Pierce K, Clegg F. A completed audit cycle and integrated care pathway for the management of depression following brain injury in a rehabilitation setting. *Clinical Rehabilitation*. 2002; 16(5):534-540
- 192 Hassan Z, Smith M, Littlewood S, Bouamra O, Hughes D, Biggin C et al. Head injuries: a study evaluating the impact of the NICE head injury guidelines. *Emergency Medicine Journal: EMJ*. 2005; 22(12):845-849
- 193 Hawley A. Reported problems and their resolution following mild, moderate and severe traumatic brain injury amongst children and adolescents in the UK. *Brain Injury*. 2003; 17(2):105-129
- 194 Haydel MJ, Preston CA, Mills TJ, Luber S, Blaudeau E, DeBlieux PM. Indications for computed tomography in patients with minor head injury. *New England Journal of Medicine*. 2000; 343(2):100-105
- 195 Haydel MJ, Shembekar AD. Prediction of intracranial injury in children aged five years and older with loss of consciousness after minor head injury due to nontrivial mechanisms. *Annals of Emergency Medicine*. 2003; 42(4):507-514
- 196 Hedges JR, Feero S, Moore B, Haver DW, Shultz B. Comparison of prehospital trauma triage instruments in a semirural population. *Journal of Emergency Medicine*. 1987; 5(3):197-208
- 197 Hendeley GW, Wolfson AB, Mower WR, Hoffman JR. Spinal cord injury without radiographic abnormality: results of the National Emergency X-Radiography Utilization Study in blunt cervical trauma. *Journal of Trauma*. 2002; 53(1):1-4
- 198 Heng KWJ, Tham KY, How KY, Foo JS, Lau YH, Li AYK. Recall of discharge advice given to patients with minor head injury presenting to a Singapore emergency department. *Singapore Medical Journal*. 2007; 48(12):1107-1110
- 199 Hennessy D, Widder S, Zygun D, Hurlbert RJ, Burrowes P, Kortbeek JB. Cervical spine clearance in obtunded blunt trauma patients: a prospective study. *Journal of Trauma*. 2010; 68(3):576-582

- 200 Henry MC, Hollander JE, Alicandro JM, Cassara G, O'Malley S, Thode HCJ. Incremental benefit of individual American College of Surgeons trauma triage criteria. *Academic Emergency Medicine*. 1996; 3(11):992-1000
- 201 Herbert ME. Issues in minor head injury: To CT or not to CT, that is the question. *Emergency Radiology*. 2000; 7(1):7-13
- 202 Herrmann M, Jost S, Kutz S, Ebert AD, Kratz T, Wunderlich MT et al. Temporal profile of release of neurobiochemical markers of brain damage after traumatic brain injury is associated with intracranial pathology as demonstrated in cranial computerized tomography. *Journal of Neurotrauma*. 2000; 17(2):113-122
- 203 Hessen E, Nestvold K. Indicators of complicated mild TBI predict MMPI-2 scores after 23 years. *Brain Injury : [BI]*. 2009; 23(3):234-242
- 204 Hindman BW, Watkins GE, Song AK. Evaluation of the cervical spine in the obtunded patient. *Emergency Radiology*. 1998; 5(6):391-393
- 205 Hodgkinson DW, Berry E, Yates DW. Mild head injury--a positive approach to management. *European Journal of Emergency Medicine*. 1994; 1(1):9-12
- 206 Hoffman JR, Mower W. When to image cervical spine injuries. *Western Journal of Medicine*. 1991; 155(3):290
- 207 Hoffman JR, Mower WR, Wolfson AB. Absence of 5 clinical criteria ruled out cervical spine injury in blunt trauma in the emergency department. *Evidence-Based Medicine*. 2001; 6(2):63
- 208 Hoffman JR, Mower WR, Wolfson AB, Todd KH, Zucker MI. Validity of a set of clinical criteria to rule out injury to the cervical spine in patients with blunt trauma. National Emergency X-Radiography Utilization Study Group. *New England Journal of Medicine*. 2000; 343(2):94-99
- 209 Hoffman JR, Schriger DL, Mower W, Luo JS, Zucker M. Low-risk criteria for cervical-spine radiography in blunt trauma: a prospective study. *Annals of Emergency Medicine*. 1992; 21(12):1454-1460
- 210 Hoffman JR, Wolfson AB, Todd K, Mower WR. Selective cervical spine radiography in blunt trauma: methodology of the National Emergency X-Radiography Utilization Study (NEXUS). *Annals of Emergency Medicine*. 1998; 32(4):461-469
- 211 Hofman PA, Nelemans P, Kemerink GJ, Wilmink JT. Value of radiological diagnosis of skull fracture in the management of mild head injury: meta-analysis. *Journal of Neurology, Neurosurgery and Psychiatry*. 2000; 68(4):416-422
- 212 Hogan GJ, Mirvis SE, Shanmuganathan K, Scalea TM. Exclusion of unstable cervical spine injury in obtunded patients with blunt trauma: is MR imaging needed when multi-detector row CT findings are normal? *Radiology*. 2005; 237(1):106-113
- 213 Hokenstad A, Hart AY, Gould DA, Halper D, Levine C. Closing the home care case: home health aides' perspectives on family caregiving. *Home Health Care Management & Practice*. 2006; 18(4):306-314

- 214 Holliman CJ, Mayer JS, Cook RT, Jr., Smith JS, Jr. Is the anteroposterior cervical spine radiograph necessary in initial trauma screening? *American Journal of Emergency Medicine*. 1991; 9(5):421-425
- 215 Holly LT, Kelly DF, Counelis GJ, Blinman T, McArthur DL, Cryer HG. Cervical spine trauma associated with moderate and severe head injury: incidence, risk factors, and injury characteristics. *Journal of Neurosurgery*. 2002; 96(3 Suppl):285-291
- 216 Holmes J, Elms AR, Gore J, Marvil J. Validation of out-of-hospital triage criteria for pregnant blunt trauma patients. *Annals of Emergency Medicine*. 2011; 58(4 SUPPL. 1):S242
- 217 Holmes JF, Baier ME, Derlet RW. Failure of the Miller criteria to predict significant intracranial injury in patients with a Glasgow Coma Scale score of 14 after minor head trauma. *Academic Emergency Medicine*. 1997; 4(8):788-792
- 218 Holmes JF, Akkinapalli R. Computed tomography versus plain radiography to screen for cervical spine injury: a meta-analysis. *Journal of Trauma*. 2005; 58(5):902-905
- 219 Honda M, Tsuruta R, Kaneko T, Kasaoka S, Yagi T, Todani M et al. Serum glial fibrillary acidic protein is a highly specific biomarker for traumatic brain injury in humans compared with S-100B and neuron-specific enolase. *Journal of Trauma-Injury Infection & Critical Care*. Advanced Medical Emergency and Critical Care Center, Yamaguchi University Hospital, Yamaguchi, Japan. 2010; 69(1):104-109
- 220 Howard JL, Cipolle MD, Horvat SA, Sabella VM, Reed JF, III, Fulda G et al. Preinjury warfarin worsens outcome in elderly patients who fall from standing. *Journal of Trauma-Injury Infection & Critical Care*. Department of Surgery, Division of Trauma/Surgical Critical Care, Lehigh Valley Health Network, Allentown, Pennsylvania 18105-1556, USA. 2009; 66(6):1518-1522
- 221 Hsiang JN, Yeung T, Yu AL, Poon WS. High-risk mild head injury. *Journal of Neurosurgery*. 1997; 87(2):234-238
- 222 Hung CC, Chiu WT, Lee LS, Lin LS, Shih CJ. Risk factors predicting surgically significant intracranial hematomas in patients with head injuries. *Journal of the Formosan Medical Association*. 1996; 95(4):294-297
- 223 Hutchings L, Atijosan O, Burgess C, Willett K. Developing a spinal clearance protocol for unconscious pediatric trauma patients. *Journal of Trauma*. 2009; 67(4):681-686
- 224 Ibañez J, Arian F, Pedraza S, Sánchez E, Poca MA, Rodriguez D et al. Reliability of clinical guidelines in the detection of patients at risk following mild head injury: results of a prospective study. *Journal of Neurosurgery*. 2004; 100(5):825-834
- 225 Ingebrigtsen T, Romner B, Kock-Jensen C. Scandinavian guidelines for initial management of minimal, mild, and moderate head injuries. The Scandinavian Neurotrauma Committee. *Journal of Trauma*. 2000; 48(4):760-766
- 226 Ingebrigtsen T, Trumphy JH, Anke IM. Minor head injuries. May early CT-scanning replace in-hospital observation? *Tidsskr Nor Laegeforen*. 1995; 115(13):1601-1603
- 227 Ivascu FA, Howells GA, Junn FS, Bair HA, Bendick PJ, Janczyk RJ. Predictors of mortality in trauma patients with intracranial hemorrhage on preinjury aspirin or clopidogrel. *Journal of Trauma-National Clinical Guideline Centre*, 2014.

- Injury Infection & Critical Care. William Beaumont Hospital, Royal Oak, Michigan, USA. fivascu@beaumont.edu 2008; 65(4):785-788
- 228 Ivascu FA, Janczyk RJ, Junn FS, Bair HA, Bendick PJ, Howells GA. Treatment of trauma patients with intracranial hemorrhage on preinjury warfarin. *Journal of Trauma*. 2006; 61(2):318-321
- 229 Jacobs LM, Schwartz R. Prospective analysis of acute cervical spine injury: a methodology to predict injury. *Annals of Emergency Medicine*. 1986; 15(1):44-49
- 230 Jaffe DM, Binns H, Radkowski MA, Barthel MJ, Engelhard HH. Developing a clinical algorithm for early management of cervical spine injury in child trauma victims. *Annals of Emergency Medicine*. 1987; 16(3):270-276
- 231 Jelly LM, Evans DR, Easty MJ, Coats TJ, Chan O. Radiography versus spiral CT in the evaluation of cervicothoracic junction injuries in polytrauma patients who have undergone intubation. *Radiographics*. 2000; 20 Spec No:S251-S259
- 232 Jen LH, Sharma V, Shah K, Gor D. The role of spiral CT vs plain films in acute cervical spine trauma: A comparative study. *Emergency Radiology*. 2001; 8(6):311-314
- 233 Jennett B. Epidemiology of head injury. *Archives of Disease in Childhood*. 1998; 78(5):403-406
- 234 Jennett B, Bond M. Assessment of outcome after severe brain damage. *Lancet*. 1975; 1(7905):480-484
- 235 Jeret JS, Mandell M, Anziska B, Lipitz M, Vilceus AP, Ware JA et al. Clinical predictors of abnormality disclosed by computed tomography after mild head trauma. *Neurosurgery*. 1993; 32(1):9-15
- 236 Jeromin A. Biomarkers in traumatic brain injury: Experimental approaches and diagnostic applications. *Biological Psychiatry*. 2012; 71(8 SUPPL. 1):238S
- 237 Kaen A, Jimenez-Roldan L, Arrese I, Delgado MA, Lopez PG, Alday R et al. The value of sequential computed tomography scanning in anticoagulated patients suffering from minor head injury. *Journal of Trauma-Injury Infection & Critical Care*. Department of Neurosurgery, Hospital 12 de Octubre, Madrid, Spain. kaenariel@hotmail.com 2010; 68(4):895-898
- 238 Kaiser ML, Whealon MD, Barrios C, Kong AP, Lekawa ME, Dolich MO. The current role of magnetic resonance imaging for diagnosing cervical spine injury in blunt trauma patients with negative computed tomography scan. *American Surgeon*. 2012; 78(10):1156-1160
- 239 Kalina M, Tinkoff G, Gbadebo A, Veneri P, Fulda G. A protocol for the rapid normalization of INR in trauma patients with intracranial hemorrhage on prescribed warfarin therapy. *American Surgeon*. 2008; 74(9):858-861
- 240 Kasimatis GB, Panagiotopoulos E, Megas P, Matzaroglou C, Gliatis J, Tyllianakis M et al. The adult spinal cord injury without radiographic abnormalities syndrome: magnetic resonance imaging and clinical findings in adults with spinal cord injuries having normal radiographs and computed tomography studies. *Journal of Trauma*. 2008; 65(1):86-93

- 241 Katzberg RW, Benedetti PF, Drake CM, Ivanovic M, Levine RA, Beatty CS et al. Acute cervical spine injuries: prospective MR imaging assessment at a level 1 trauma center. *Radiology*. 1999; 213(1):203-212
- 242 Keenan A, Joseph L. The needs of family members of severe traumatic brain injured patients during critical and acute care: a qualitative study. *Canadian Journal of Neuroscience Nursing*. 2010; 32(3):25-35
- 243 Keenan HT, Hollingshead MC, Chung CJ, Ziglar MK. Using CT of the cervical spine for early evaluation of pediatric patients with head trauma. *AJR American Journal of Roentgenology*. 2001; 177(6):1405-1409
- 244 Keiper MD, Zimmerman RA, Bilaniuk LT. MRI in the assessment of the supportive soft tissues of the cervical spine in acute trauma in children. *Neuroradiology*. 1998; 40(6):359-363
- 245 Kejriwal R, Civil I. Time to definitive care for patients with moderate and severe traumatic brain injury--does a trauma system matter? *New Zealand Medical Journal*. 2009; 122(1302):40-46
- 246 Kelly AB, Zimmerman RD, Snow RB, Gandy SE, Heier LA, Deck MD. Head trauma: comparison of MR and CT--experience in 100 patients. *AJNR American Journal of Neuroradiology*. 1988; 9(4):699-708
- 247 Kelly AM, Kerr D. Are too many head CT scans ordered in emergency departments? *Emergency Medicine*. 2000; 12(1):50-54
- 248 Kerr J, Beard D, Smith R, Gray S, Robertson CE, Dunn LT et al. Implications of full compliance with the computed tomography scanning recommendations of the National Institute for Clinical Excellence and Scottish Intercollegiate Guidelines Network guidelines for the management of head injury. *European Journal of Emergency Medicine*. 2007; 14(3):147-150
- 249 Kerr J, Swann IJ, Pentland B. A survey of information given to head-injured patients on direct discharge from emergency departments in Scotland. *Emergency Medicine Journal*. 2007; 24(5):330-332
- 250 Keskil IS, Baykaner MK, Ceviker N, Kaymaz M. Assessment of mortality associated with mild head injury in the pediatric age group. *Childs Nervous System*. 1995; 11(8):467-473
- 251 Kirshenbaum KJ, Nadimpalli SR, Fantus R, Cavallino RP. Unsuspected upper cervical spine fractures associated with significant head trauma: role of CT. *Journal of Emergency Medicine*. 1990; 8(2):183-198
- 252 Klein GR, Vaccaro AR, Albert TJ, Schweitzer M, Deely D, Karasick D et al. Efficacy of magnetic resonance imaging in the evaluation of posterior cervical spine fractures. *Spine*. 1999; 24(8):771-774
- 253 Koelfen W, Freund M, Dinter D, Schmidt B, Koenig S, Schultze C. Long-term follow up of children with head injuries-classified as "good recovery" using the Glasgow Outcome Scale: neurological, neuropsychological and magnetic resonance imaging results. *European Journal of Pediatrics*. 1997; 156(3):230-235
- 254 Kotlyar S, Larkin GL, Moore CL, D'Onofrio G. S100b immunoassay: an assessment of diagnostic utility in minor head trauma. *Journal of Emergency Medicine*. 2011; 41(3):285-293

- 255 Kreipke DL, Gillespie KR, McCarthy MC, Mail JT, Lappas JC, Broadie TA. Reliability of indications for cervical spine films in trauma patients. *Journal of Trauma*. 1989; 29(10):1438-1439
- 256 Kriss VM, Kriss TC. SCIWORA (spinal cord injury without radiographic abnormality) in infants and children. *Clinical Pediatrics*. 1996; 35(3):119-124
- 257 Kriss VM, Kriss TC. Imaging of the cervical spine in infants. *Pediatric Emergency Care*. 1997; 13(1):44-49
- 258 Kuppermann N, Holmes JF, Dayan PS, Hoyle JD, Jr., Atabaki SM, Holubkov R et al. Identification of children at very low risk of clinically-important brain injuries after head trauma: a prospective cohort study. *Lancet*. Department of Emergency Medicine, University of California, Davis School of Medicine, Davis, CA, USA. nkuppermann@ucdavis.edu 2009; 374(9696):1160-1170
- 259 Laham JL, Cotcamp DH, Gibbons PA, Kahana MD, Crone KR. Isolated head injuries versus multiple trauma in pediatric patients: do the same indications for cervical spine evaluation apply? *Pediatric Neurosurgery*. 1994; 21(4):221-226
- 260 Lange RT, Iverson GL, Brubacher JR. Clinical utility of the protein S100B to evaluate traumatic brain injury in the presence of acute alcohol intoxication. *Journal of Head Trauma Rehabilitation*. 2012; 27(2):123-134
- 261 Lapierre F. Guidelines for head injured patients management in adult age. *Neurosurgical Society of France*. *Neuro-Chirurgie*. 1998; 44(1):55-56
- 262 Lavoie A, Ratte S, Clas D, Demers J, Moore L, Martin M et al. Preinjury warfarin use among elderly patients with closed head injuries in a trauma center. *Journal of Trauma*. 2004; 56(4):802-807
- 263 Lee H, Wintermark M, Gean AD, Ghajar J, Manley GT, Mukherjee P. Focal lesions in acute mild traumatic brain injury and neurocognitive outcome: CT versus 3T MRI. *Journal of Neurotrauma*. 2008; 25(9):1049-1056
- 264 Lee LK, Dayan PS, Gerardi MJ, Borgialli DA, Badawy MK, Callahan JM et al. Intracranial hemorrhage after blunt head trauma in children with bleeding disorders. *Journal of Pediatrics*. 2011; 158(6):1003-1008
- 265 Lee SJ, Kim CW, Lee KJ, Choe JW, Kim SE, Oh JH et al. Elevated serum S100B levels in acute spinal fracture without head injury. *Emergency Medicine Journal*. 2010; 27(3):209-212
- 266 Leiblich A, Mason S. Emergency management of minor head injury in anticoagulated patients. *Emergency Medicine Journal*. 2011; 28(2):115-118
- 267 Leonard JC, Kuppermann N, Olsen C, Babcock-Cimpello L, Brown K, Mahajan P et al. Factors associated with cervical spine injury in children after blunt trauma. *Annals of Emergency Medicine*. 2011; 58(2):145-155
- 268 Levi L, Guilburd JN, Linn S, Feinsod M. The association between skull fracture, intracranial pathology and outcome in pediatric head injury. *British Journal of Neurosurgery*. 1991; 5(6):617-625
- 269 Levitt MA, Cook LA, Simon BC, Williams V. Biochemical markers of cerebral injury in patients with minor head trauma and ethanol intoxication. *Academic Emergency Medicine*. 1995; 2(8):675-680

- 270 Lewis LM, Docherty M, Ruoff BE, Fortney JP, Keltner RA, Jr., Britton P. Flexion-extension views in the evaluation of cervical-spine injuries. *Annals of Emergency Medicine*. 1991; 20(2):117-121
- 271 Li J, Brown J, Levine M. Mild head injury, anticoagulants, and risk of intracranial injury. *Lancet*. 2001; 357(9258):771-772
- 272 Liddle J, Fleming J, McKenna K, Turpin M, Whitelaw P, Allen S. Driving and driving cessation after traumatic brain injury: processes and key times of need. *Disability and Rehabilitation*. 2011; 33(25-26):2574-2586
- 273 Lind K, Klein K, Likourezos A, Lam S, Nevarez C, Evelsizer S et al. Is CT the only way? Can the S-100 protein be used in the emergency department to decrease the number of cts? *Annals of Emergency Medicine*. 2011; 58(4 SUPPL. 1):S208
- 274 Link TM, Schuierer G, Hufendiek A, Horch C, Peters PE. Substantial head trauma: value of routine CT examination of the cervicocranium. *Radiology*. 1995; 196(3):741-745
- 275 Link TM, Schuierer G, Hufendiek A, Peters PE. Fractures of the cervical spine. Diagnosis in multiple trauma patients. *Radiologie*. 1994; 34(12):721-727
- 276 Livingston DH, Lavery RF, Passannante MR, Skurnick JH, Baker S, Fabian TC et al. Emergency department discharge of patients with a negative cranial computed tomography scan after minimal head injury. *Annals of Surgery*. 2000; 232(1):126-132
- 277 Livingston DH, Loder PA, Hunt CD. Minimal head injury: is admission necessary? *American Surgeon*. 1991; 57(1):14-17
- 278 Livingston DH, Loder PA, Koziol J, Hunt CD. The use of CT scanning to triage patients requiring admission following minimal head injury. *Journal of Trauma*. 1991; 31(4):483-487
- 279 Lloyd DA, Carty H, Patterson M, Butcher CK, Roe D. Predictive value of skull radiography for intracranial injury in children with blunt head injury. *Lancet*. 1997; 349(9055):821-824
- 280 Lohrer L, Vieth V, Nassenstein I, Hartensuer R, Niederstadt T, Raschke MJ et al. Blunt cerebrovascular injuries in acute trauma care: a screening protocol. *European Spine Journal*. 2012; 21(5):837-843
- 281 Laroni L, Ciucci G, Piccinini G, Cuscini M, Scorza P, Piola C et al. Approach to head trauma in childhood in a district general hospital. *European Journal of Emergency Medicine*. 1996; 3(3):141-148
- 282 Lucchi S, Giua G, Bettinelli A, Farabola M, Sina C, Mangiagalli E et al. The role of computerized tomography in the management of mild head injury patients. *Riv Neuroradiol*. 1995; 8(3):415-428
- 283 Lumpkins KM, Bochicchio GV, Keledjian K, Simard JM, McCunn M, Scalea T. Glial fibrillary acidic protein is highly correlated with brain injury. *Journal of Trauma*. 2008; 65(4):778-784
- 284 Maas AIR, Steyerberg EW, Butcher I, Dammers R, Lu J, Marmarou A et al. Prognostic value of computerized tomography scan characteristics in traumatic brain injury: results from the IMPACT study. *Journal of Neurotrauma*. 2007; 24(2):303-314

- 285 MacDonald RL, Schwartz ML, Mirich D, Sharkey PW, Nelson WR. Diagnosis of cervical spine injury in motor vehicle crash victims: how many X-rays are enough? *Journal of Trauma*. 1990; 30(4):392-397
- 286 Madden C, Witzkc DB, Arthur, Sanders B, Valente J, Fritz M. High-yield selection criteria for cranial computed tomography after acute trauma. *Academic Emergency Medicine*. 1995; 2(4):248-253
- 287 Mahmood NS, Kadavigere R, Ramesh AK. Cervical spinal cord injury with and without the radiographical evidence of trauma - A retrospective comparative study in adults. *Journal of Clinical and Diagnostic Research*. 2010; 4(2):2183-2189
- 288 Major J, Reed MJ. A retrospective review of patients with head injury with coexistent anticoagulant and antiplatelet use admitted from a UK emergency department. *Emergency Medicine Journal*. College of Medicine and Veterinary Medicine, University of Edinburgh, Edinburgh, UK. 2009; 26(12):871-876
- 289 Malomo AO, Shokunbi MT, Adeloye A. Evaluation of the use of plain cervical spine radiography in patients with head injury. *East African Medical Journal*. 1995; 72(3):186-188
- 290 Mander M, Wencil T, Bazowski P, Krauze J. How should we manage children after mild head injury? *Childs Nervous System*. 2000; 16(3):156-160
- 291 Mannix R, Bourgeois FT, Schutzman SA, Bernstein A, Lee LK. Neuroimaging for pediatric head trauma: do patient and hospital characteristics influence who gets imaged? *Academic Emergency Medicine*. 2010; 17(7):694-700
- 292 Masson F, Vecsey J, Salmi LR, Dartigues JF, Erny P, Maurette P. Disability and handicap 5 years after a head injury: a population-based study. *Journal of Clinical Epidemiology*. 1997; 50(5):595-601
- 293 Maurice S, Brown S, Robertson C, Beggs I. The effect of introducing guidelines for cervical spine radiographs in the accident and emergency department. *Journal of Accident and Emergency Medicine*. 1996; 13(1):38-40
- 294 McCulloch PT, France J, Jones DL, Krantz W, Nguyen TP, Chambers C et al. Helical computed tomography alone compared with plain radiographs with adjunct computed tomography to evaluate the cervical spine after high-energy trauma. *Journal of Bone and Joint Surgery American Volume*. 2005; 87(11):2388-2394
- 295 McDonald TW, Franzen MD. A validity study of the WAIT in closed head injury. *Brain Injury*. 1999; 13(5):331-346
- 296 McGregor K, Pentland B. Head injury rehabilitation in the U.K.: an economic perspective. *Social Science and Medicine*. 1997; 45(2):295-303
- 297 McMillan TM, McKenzie P, Swann IJ, Weir CJ, McAviney A. Head injury attenders in the emergency department: the impact of advice and factors associated with early symptom outcome. *Brain Injury*. 2009; 23(6):509-515
- 298 McNamara RM, Heine E, Esposito B. Cervical spine injury and radiography in alert, high-risk patients. *Journal of Emergency Medicine*. 1990; 8(2):177-182

- 299 McNamara RM, O'Brien MC, Davidheiser S. Post-traumatic neck pain: a prospective and follow-up study. *Annals of Emergency Medicine*. 1988; 17(9):906-911
- 300 Melville LD, Tanaka R. History of anticoagulation and head trauma in elderly patients: Is there really an increased risk of bleeding? *Academic Emergency Medicine*. 2012; 19:S186
- 301 Menaker J, Philp A, Boswell S, Scalea TM. Computed tomography alone for cervical spine clearance in the unreliable patient - Are we there yet? *Journal of Trauma-Injury Infection & Critical Care*. 2008; 64(4):898-903
- 302 Menaker J, Stein DM, Philp AS, Scalea TM. 40-slice multidetector CT: is MRI still necessary for cervical spine clearance after blunt trauma? *American Surgeon*. 2010; 76(2):157-163
- 303 Menditto VG, Lucci M, Polonara S, Pomponio G, Gabrielli A. Management of minor head injury in patients receiving oral anticoagulant therapy: a prospective study of a 24-hour observation protocol. *Annals of Emergency Medicine*. 2012; 59(6):451-455
- 304 Menon DK, Schwab K, Wright DW, Maas AI. Position statement: definition of traumatic brain injury. *Archives of Physical Medicine and Rehabilitation*. 2010; 91(11):1637-1640
- 305 Mercier E, Turgeon AF, Boutin A, Lauzier F, Zarychanski R, Archambault P et al. Predictive value of neuron-specific enolase following moderate and severe traumatic brain injury: A systematic review and meta-analysis. *Critical Care*. 2012; 16:S112-S113
- 306 Michaleff ZA, Maher CG, Verhagen AP, Rebeck T, Lin CWC. Accuracy of the Canadian C-spine rule and NEXUS to screen for clinically important cervical spine injury in patients following blunt trauma: a systematic review. *CMAJ Canadian Medical Association Journal*. 2012; 184(16):E867-E876
- 307 Mikhail MG, Levitt MA, Christopher TA, Sutton MC. Intracranial injury following minor head trauma. *American Journal of Emergency Medicine*. 1992; 10(1):24-26
- 308 Miller EC, Derlet RW, Kinser D. Minor head trauma: Is computed tomography always necessary? *Annals of Emergency Medicine*. 1996; 27(3):290-294
- 309 Miller EC, Holmes JF, Derlet RW. Utilizing clinical factors to reduce head CT scan ordering for minor head trauma patients. *Journal of Emergency Medicine*. 1997; 15(4):453-457
- 310 Miller JD, Sweet RC, Narayan R, Becker DP. Early insults to the injured brain. *JAMA*. 1978; 240(5):439-442
- 311 Millis SR. Assessment of motivation and memory with the Recognition Memory Test after financially compensable mild head injury. *Journal of Clinical Psychology*. 1994; 50(4):601-605
- 312 Mina AA, Bair HA, Howells GA, Bendick PJ. Complications of preinjury warfarin use in the trauma patient. *Journal of Trauma*. 2003; 54(5):842-847
- 313 Mirvis SE, Shanmuganathan K. Trauma radiology: Part V. Imaging of acute cervical spine trauma. *Journal of Intensive Care Medicine*. 1995; 10(1):15-33
- 314 Mittal R, Vermani E, Tweedie I, Nee PA. Critical care in the emergency department: traumatic brain injury. *Emergency Medicine Journal*. 2009; 26(7):513-517

- 315 Mittenberg W, Wittner MS, Miller LJ. Postconcussion syndrome occurs in children. *Neuropsychology*. 1997; 11(3):447-452
- 316 Moak JH, Gong DX, Young JS, Sochor MR. Guidelines for cervical spine imaging in patients with blunt trauma: Utilization and outcomes. *Annals of Emergency Medicine*. 2011; 58(4 SUPPL. 1):S272-S273
- 317 Moen KG, Klepstad P, Skandsen T, Fredriksli OA, Vik A. Direct transport versus interhospital transfer of patients with severe head injury in Norway. *European Journal of Emergency Medicine*. 2008; 15(5):249-255
- 318 Moen KG, Skandsen T, Karlsen BH, Hara S, Solheim O, Strand IH et al. Patients with severe head injury in Norway - Transfer and outcome. *Journal of Neurotrauma*. 2009; 26(8):A35
- 319 Mohanty SK, Thompson W, Rakower S. Are CT scans for head injury patients always necessary? *Journal of Trauma*. 1991; 31(6):801-804
- 320 Moore C, Leathem J. Information provision after mild traumatic brain injury (MTBI): a survey of general practitioners and hospitals in New Zealand. *New Zealand Medical Journal*. 2004; 117(1201):U1046
- 321 Moran SG, McCarthy MC, Uddin DE, Poelstra RJ. Predictors of positive CT scans in the trauma patient with minor head injury. *American Surgeon*. 1994; 60(7):533-535
- 322 Morochovic R, Racz O, Kitka M, Pingorova S, Cibur P, Tomkova D et al. Serum S100B protein in early management of patients after mild traumatic brain injury. *European Journal of Neurology*. Department of Trauma Surgery, School of Medicine, University of P.J.Safarik, Kosice, Slovak Republic. rado17@post.sk 2009; 16(10):1112-1117
- 323 Morris JAJ, Auerbach PS, Marshall GA, Bluth RF, Johnson LG, Trunkey DD. The Trauma Score as a triage tool in the prehospital setting. *JAMA*. 1986; 256(10):1319-1325
- 324 Morton MJ, Rothman RE, Mundangepfufu T, Zhou T, Mohareb A, Korley F. EMFprovider adherence to head ct utilization guidelines for mild traumatic brain injury. *Annals of Emergency Medicine*. 2011; 58(4 SUPPL. 1):S207-S208
- 325 Mosconi P, Taricco M, Bergamini M, Bosisio Fazzi L, Colombo C, Patrucco V et al. Family burden after severe brain injury: the Italian experience with families and volunteer associations. *Patient*. 2011; 4(1):55-65
- 326 Mower WR, Hoffman JR, Herbert M, Wolfson AB, Pollack CV, Jr., Zucker MI. Developing a clinical decision instrument to rule out intracranial injuries in patients with minor head trauma: methodology of the NEXUS II investigation. *Annals of Emergency Medicine*. 2002; 40(5):505-514
- 327 Mower WR, Hoffman JR, Herbert M, Wolfson AB, Pollack CV, Jr., Zucker MI. Developing a decision instrument to guide computed tomographic imaging of blunt head injury patients. *Journal of Trauma*. 2005; 59(4):954-959
- 328 Mower WR, Hoffman JR, Pollack CV, Jr., Zucker MI, Browne BJ, Wolfson AB. Use of plain radiography to screen for cervical spine injuries. *Annals of Emergency Medicine*. 2001; 38(1):1-7

- 329 Mower WR, Hoffman JR, Schriger DL. The feasibility of selective radiography in patients with trauma-induced neck pain [abstract]. *Annals of Emergency Medicine*. 1990; 19 Suppl 1:220-221
- 330 Muchow RD, Resnick DK, Abdel MP, Munoz A, Anderson PA. Magnetic resonance imaging (MRI) in the clearance of the cervical spine in blunt trauma: a meta-analysis. *Journal of Trauma-Injury Infection & Critical Care*. Departments of Orthopedic Surgery and Rehabilitation, University of Wisconsin, Madison, Wisconsin, USA. 2008; 64(1):179-189
- 331 Muller B, Evangelopoulos DS, Bias K, Wildisen A, Zimmermann H, Exadaktylos AK. Can S-100B serum protein help to save cranial CT resources in a peripheral trauma centre? A study and consensus paper. *Emergency Medicine Journal*. 2011; 28(11):938-940
- 332 Muller K, Townend W, Biasca N, Uden J, Waterloo K, Romner B et al. S100B serum level predicts computed tomography findings after minor head injury. *Journal of Trauma-Injury Infection & Critical Care*. Department of Neurosurgery, University Hospital of North Norway, Tromsø, Norway. 2007; 62(6):1452-1456
- 333 Murgio A, Patrick PD, Andrade FA, Boetto S, Leung KM, Munoz Sanchez MA. International study of emergency department care for pediatric traumatic brain injury and the role of CT scanning. *Childs Nervous System*. 2001; 17(4-5):257-262
- 334 Murray GD, Butcher I, McHugh GS, Lu J, Mushkudiani NA, Maas AIR et al. Multivariable prognostic analysis in traumatic brain injury: results from the IMPACT study. *Journal of Neurotrauma*. 2007; 24(2):329-337
- 335 Murray HM, Maslany GW, Jeffery B. Assessment of family needs following acquired brain injury in Saskatchewan. *Brain Injury*. 2006; 20(6):575-585
- 336 Murshid WR. Role of skull radiography in the initial evaluation of minor head injury: a retrospective study. *Acta Neurochirurgica*. 1994; 129(1-2):11-14
- 337 Murshid WR. Management of minor head injuries: admission criteria, radiological evaluation and treatment of complications. *Acta Neurochirurgica*. 1998; 140(1):56-64
- 338 Mussack T, Biberthaler P, Kanz KG, Heckl U, Gruber R, Linsenmaier U et al. Immediate S-100B and neuron-specific enolase plasma measurements for rapid evaluation of primary brain damage in alcohol-intoxicated, minor head-injured patients. *Shock*. 2002; 18(5):395-400
- 339 Mussack T, Biberthaler P, Wiedemann E, Kanz KG, Englert A, Gippner-Steppert C et al. S-100b as a screening marker of the severity of minor head trauma (MHT)--a pilot study. *Acta Neurochirurgica Supplement*. 2000; 76:393-396
- 340 Naeimi ZS, Weinhofer A, Sarahrudi K, Heinz T, Vécsei V. Predictive value of S-100B protein and neuron specific-enolase as markers of traumatic brain damage in clinical use. *Brain Injury*. 2006; 20(5):463-468
- 341 Nagy KK, Joseph KT, Krosner SM, Roberts RR, Leslie CL, Dufty K et al. The utility of head computed tomography after minimal head injury. *Journal of Trauma*. 1999; 46(2):268-270
- 342 Nalder E, Fleming J, Cornwell P, Foster M, Haines T. Factors associated with the occurrence of sentinel events during transition from hospital to home for individuals with traumatic brain injury. *Journal of Rehabilitation Medicine*. 2012; 44(10):837-844

- 343 Nalder E, Fleming J, Foster M, Cornwell P, Shields C, Khan A. Identifying factors associated with perceived success in the transition from hospital to home after brain injury. *Journal of Head Trauma Rehabilitation*. 2012; 27(2):143-153
- 344 National Collaborating Centre for Acute Care. Head injury: triage, assessment, investigation and early management of head injury in infants, children and adults. NICE clinical guideline 4. 2003. [Last accessed: 26 September 2007]
- 345 National Institute for Health and Clinical Excellence. The guidelines manual. London: National Institute for Health and Clinical Excellence; 2009. Available from: <http://www.nice.org.uk/aboutnice/howwework/developingniceclinicalguidelines/clinicalguidelinedevelopmentmethods/GuidelinesManual2009.jsp>
- 346 Neifeld GL, Keene JG, Hevesy G, Leikin J, Proust A, Thisted RA. Cervical injury in head trauma. *Journal of Emergency Medicine*. 1988; 6(3):203-207
- 347 Nelson DW, Nystrom H, MacCallum RM, Thornquist B, Lilja A, Bellander BM et al. Extended analysis of early computed tomography scans of traumatic brain injured patients and relations to outcome. *Journal of Neurotrauma*. 2010; 27(1):51-64
- 348 Nelson JB, Bresticker MA, Nahrwold DL. Computed tomography in the initial evaluation of patients with blunt trauma. *Journal of Trauma*. 1992; 33(5):722-727
- 349 Newgard CD, Rudser K, Hedges JR, Kerby JD, Stiell IG, Davis DP et al. A critical assessment of the out-of-hospital trauma triage guidelines for physiologic abnormality. *Journal of Trauma - Injury, Infection and Critical Care*. 2010; 68(2):452-462
- 350 Newgard CD, Hui SHJ, Griffin A, Wuerstle M, Pratt F, Lewis RJ. Prospective validation of an out-of-hospital decision rule to identify seriously injured children involved in motor vehicle crashes. *Academic Emergency Medicine*. 2005; 12(8):679-687
- 351 Newgard CD, Zive D, Holmes JF, Bulger EM, Staudenmayer K, Liao M et al. A multisite assessment of the American College of Surgeons Committee on Trauma field triage decision scheme for identifying seriously injured children and adults. *Journal of the American College of Surgeons*. 2011; 213(6):709-721
- 352 Nguyen GK, Clark R. Adequacy of plain radiography in the diagnosis of cervical spine injuries. *Emergency Radiology*. 2005; 11(3):158-161
- 353 Nishijima DK, Holmes JF. A clinical decision rule to predict adult patients with traumatic brain injury who do not need intensive care unit admission. *Clinical and Translational Science*. 2010; 3(2):S27
- 354 Nishijima DK, Offerman SR, Ballard D, Chettipally U, Vinson D, Rauchwerger A et al. The prevalence of immediate and delayed intracranial hemorrhage in patients with pre-injury anticoagulant use and head trauma. *Academic Emergency Medicine*. 2011; 18(5 SUPPL. 1):S180
- 355 Nishijima DK, Dager WE, Schrot RJ, Holmes JF. The efficacy of factor VIIa in emergency department patients with warfarin use and traumatic intracranial hemorrhage. *Academic Emergency Medicine*. 2010; 17(3):244-251

- 356 Nishijima DK, Offerman SR, Ballard DW, Vinson DR, Chettipally UK, Rauchwerger AS et al. Risk of traumatic intracranial hemorrhage in patients with head injury and preinjury warfarin or clopidogrel use. *Academic Emergency Medicine*. 2013; 20(2):140-145
- 357 Nishijima DK, Offerman SR, Ballard DW, Vinson DR, Chettipally UK, Rauchwerger AS et al. Immediate and delayed traumatic intracranial hemorrhage in patients with head trauma and preinjury warfarin or clopidogrel use. *Annals of Emergency Medicine*. 2012; 59(6):460
- 358 Norlund A, Marke LA, af Geijerstam JL, Oredsson S, Britton M. Immediate computed tomography or admission for observation after mild head injury: cost comparison in randomised controlled trial. *BMJ*. 2006; 333(7566):469
- 359 Nunez DB, Jr., Zuluaga A, Fuentes-Bernardo DA, Rivas LA, Becerra JL. Cervical spine trauma: how much more do we learn by routinely using helical CT? *Radiographics*. 1996; 16(6):1307-1318
- 360 O'Callaghan AM, McAllister L, Wilson L. Experiences of care: perspectives of carers of adults with traumatic brain injury. *International Journal of Speech-Language Pathology*. 2011; 13(3):218-226
- 361 O'Malley K, Lawrence S. Traumatic brain injury education: an effective model for clients and families. *OT Practice*. 2011; 16(2):13-17
- 362 Ogasawara K, Numagami Y, Kitahara M. How mild is mild head injury? A neuropsychiatric study. *Brain and Cognition*. 2000; 44(1):83-86
- 363 Oh EJ, Kim YM, Jegal DW, Kahng J, Park YJ, Han K. Diagnostic value of Elecsys S100 as a marker of acute brain injury in the emergency department. *Journal of Clinical Laboratory Analysis*. 2007; 21(6):387-392
- 364 Oman JA, Cooper RJ, Holmes JF, Viccellio P, Nyce A, Ross SE et al. Performance of a decision rule to predict need for computed tomography among children with blunt head trauma. *Pediatrics*. 2006; 117(2):e238-e246
- 365 Ong AW, Rodriguez A, Kelly R, Cortes V, Protetch J, Daffner RH. Detection of cervical spine injuries in alert, asymptomatic geriatric blunt trauma patients: who benefits from radiologic imaging? *American Surgeon*. 2006; 72(9):773-777
- 366 Ono K, Wada K, Takahara T, Shirotani T. Indications for computed tomography in patients with mild head injury. *Neurologia Medico-Chirurgica*. 2007; 47(7):291-297
- 367 Ornato J, Mlinek EJJ, Craren EJ, Nelson N. Ineffectiveness of the trauma score and the CRAMS scale for accurately triaging patients to trauma centers. *Annals of Emergency Medicine*. 1985; 14(11):1061-1064
- 368 Osenbach RK, Menezes AH. Spinal cord injury without radiographic abnormality in children. *Pediatric Neuroscience*. 1989; 15(4):168-175
- 369 Osmond MH, Correll R, Klassen T, Wells G, Belanger F, Boutis K et al. Multicentre prospective validation of the Canadian assessment of tomography for childhood head injury (CATCH) rule. *Canadian Journal of Emergency Medicine*. 2012; 14:S6-S7

- 370 Osmond MH, Klassen TP, Stiell IG, Correll R. The CATCH Rule: a clinical decision rule for the computed tomography of the head in children with minor head injury. *Academic Emergency Medicine*. 2006; 13:S11
- 371 Osmond MH, Klassen TP, Wells GA, Correll R, Jarvis A, Joubert G et al. CATCH: a clinical decision rule for the use of computed tomography in children with minor head injury. *CMAJ Canadian Medical Association Journal*. Department of Pediatrics, University of Ottawa and the Clinical Research Unit, Children's Hospital of Eastern Ontario Research Institute, Ottawa, Ontario. osmond@cheo.on.ca 2010; 182(4):341-348
- 372 Ott MM, Eriksson E, Vanderkolk W, Christianson D, Davis A, Scholten D. Antiplatelet and anticoagulation therapies do not increase mortality in the absence of traumatic brain injury. *Journal of Trauma-Injury Infection & Critical Care*. Grand Rapids/Michigan State University General Surgery Residency Program, Grand Rapids, Michigan, USA. meilingerott@hotmail.com 2010; 68(3):560-563
- 373 Otte A, Jeungling FD, Nitzsche EU. Rethinking mild head injury. *Journal of Vascular Investigation*. 1998; 4(1):45-46
- 374 Packard RC. Mild head injury. *Headache Q*. 1993; 4(1):42-52
- 375 Palchak MJ, Holmes JF, Vance CW, Gelber RE, Schauer BA, Harrison MJ et al. A decision rule for identifying children at low risk for brain injuries after blunt head trauma. *Annals of Emergency Medicine*. 2003; 42(4):492-506
- 376 Palmer SH, Maheson M. A radiological review of cervical spine injuries from an accident and emergency department: has the ATLS made a difference? *Journal of Accident and Emergency Medicine*. 1995; 12(3):189-190
- 377 Panacek EA, Mower WR, Holmes JF, Hoffman JR. Test performance of the individual NEXUS low-risk clinical screening criteria for cervical spine injury. *Annals of Emergency Medicine*. 2001; 38(1):22-25
- 378 Panczykowski DM, Tomycz ND, Okonkwo DO. Comparative effectiveness of using computed tomography alone to exclude cervical spine injuries in obtunded or intubated patients: Meta-analysis of 14,327 patients with blunt trauma - A review. *Journal of Neurosurgery*. 2011; 115(3):541-549
- 379 Pandor A, Goodacre S, Harnan S, Holmes M, Pickering A, Fitzgerald P et al. Diagnostic management strategies for adults and children with minor head injury: a systematic review and an economic evaluation. *Health Technology Assessment*. 2011; 15(27):1-202
- 380 Pang D. Spinal cord injury without radiographic abnormality in children, 2 decades later. *Neurosurgery*. 2004; 55(6):1325-1342
- 381 Papa L, Akinyi L, Liu MC, Pineda JA, Tepas JJ, III, Oli MW et al. Ubiquitin C-terminal hydrolase is a novel biomarker in humans for severe traumatic brain injury. *Critical Care Medicine*. Department of Emergency Medicine, Orlando Regional Medical Center, Orlando, FL, USA. lpstat@aol.com 2010; 38(1):138-144
- 382 Papa L, Lewis L, Falk JL, Silvestri S, Giordano P, Liu M-C et al. Serum levels of Glial Fibrillary Acidic Protein (GFAP) distinguish mild traumatic brain injury from trauma controls and predict
- National Clinical Guideline Centre, 2014.

- intracranial injuries on CT in mild and moderate traumatic brain injury. *Academic Emergency Medicine*. 2011; 18(5 SUPPL. 1):S5
- 383 Papa L, Silvestri S, Giordano P, Braga CF, Tan CN, Ameli NJ et al. Performance of early serum GFAP and UCH-L1 individually and in combination in distinguishing mild and moderate traumatic brain injury from trauma controls and in detecting intracranial lesions on CT. *Academic Emergency Medicine*. 2013; 20(5 SUPPL. 1):S29
- 384 Papa L, Silvestri S, Giordano P, Braga CF, Tan CN, Ameli NJ et al. Serum GFAP out-performs s100b in detecting traumatic intracranial lesions on CT in trauma patients. *Academic Emergency Medicine*. 2013; 20(5 SUPPL. 1):S115-S116
- 385 Papa L, Lewis LM, Falk JL, Zhang Z, Silvestri S, Giordano P et al. Elevated levels of serum glial fibrillary acidic protein breakdown products in mild and moderate traumatic brain injury are associated with intracranial lesions and neurosurgical intervention. *Annals of Emergency Medicine*. 2012; 59(6):471-483
- 386 Papa L, Stiell IG, Clement CM, Pawlowicz A, Wolfram A, Braga C et al. Performance of the Canadian CT Head Rule and the New Orleans Criteria for predicting any traumatic intracranial injury on computed tomography in a United States Level I trauma center. *Academic Emergency Medicine*. 2012; 19(1):2-10
- 387 Paret G, Barzilai A, Lahat E, Feldman Z, Ohad G, Vardi A et al. Children's adaptive behavioural competence after head injury. *Neuropsychological Rehabilitation*. Dr. G. Paret, Pediatric ICU, Chaim Sheba Medical Center, Tel Hashomer 52621, Israel 1993; 3(4):321-340
- 388 Pasma P, Twijnstra A, Wilmink J, Leffers P. Is skull radiography indicated in patients with head injuries? *Nederlands Tijdschrift Voor Geneeskunde*. 1992; 136(48):2370-2373
- 389 Pasma P, Twijnstra A, Wilmink J, Leffers P. The value of skull radiography in patients with head trauma. *Journal Belge De Radiologie*. 1995; 78(3):169-171
- 390 Patel HC, Bouamra O, Woodford M, King AT, Yates DW, Lecky FE. Trends in head injury outcome from 1989 to 2003 and the effect of neurosurgical care: an observational study. *Lancet*. 2005; 366(9496):1538-1544
- 391 Peck KA, Sise CB, Shackford SR, Sise MJ, Calvo RY, Sack DI et al. Delayed intracranial hemorrhage after blunt trauma: are patients on preinjury anticoagulants and prescription antiplatelet agents at risk? *Journal of Trauma*. 2011; 71(6):1600-1604
- 392 Pegg J, Auerbach SM, Seel RT, Buenaver LF, Kiesler DJ, Plybon LE. The impact of patient-centered information on patients' treatment satisfaction and outcomes in traumatic brain injury rehabilitation. *Rehabilitation Psychology*. 2005; 50(4):366-374
- 393 Perel P, Roberts I, Bouamra O, Woodford M, Mooney J, Lecky F. Intracranial bleeding in patients with traumatic brain injury: a prognostic study. *BMC Emergency Medicine*. 2009; 9:15
- 394 Perry JJ, Stiell IG. Impact of clinical decision rules on clinical care of traumatic injuries to the foot and ankle, knee, cervical spine, and head. *Injury*. 2006; 37(12):1157-1165

- 395 Pickering A. The role of biochemical markers in the identification of intracranial pathology following minor head injury: A systematic review and meta-analysis. *Emergency Medicine Journal*. 2010; 27:A7
- 396 Pickering A, Cooper K, Harnan S, Holmes M, Sutton A, Mason S et al. Comparison of direct transfer to specialist care centres with delivery to the nearest hospital: a systematic review and economic evaluation. NIHR Service Delivery and Organisation Programme, 2011
- 397 Pickering A, Harnan S, Fitzgerald P, Pandor A, Goodacre S. Clinical decision rules for children with minor head injury: a systematic review. *Archives of Disease in Childhood*. 2011; 96(5):414-421
- 398 Pieracci FM, Eachempati SR, Shou J, Hydo LJ, Barie PS. Degree of anticoagulation, but not warfarin use itself, predicts adverse outcomes after traumatic brain injury in elderly trauma patients. *Journal of Trauma-Injury Infection & Critical Care*. Department of Surgery and Public Health, Weill Medical College of Cornell University, New York, New York 10021, USA. frp9005@med.cornell.edu 2007; 63(3):525-530
- 399 Pieretti-Vanmarcke R, Velmahos GC, Nance ML, Islam S, Falcone RAJ, Wales PW et al. Clinical clearance of the cervical spine in blunt trauma patients younger than 3 years: a multi-center study of the american association for the surgery of trauma. *Journal of Trauma*. 2009; 67(3):543-550
- 400 Poli-de-Figueiredo LF, Biberthaler P, Simao FC, Hauser C, Mutschler W, Jochum M. Measurement of S-100B for risk classification of victims sustaining minor head injury -- first pilot study in Brazil. *Clinics (São Paulo Brazil)*. 2006; 61(1):41-46
- 401 Pollack CV, Jr., Hendey GW, Martin DR, Hoffman JR, Mower WR. Use of flexion-extension radiographs of the cervical spine in blunt trauma. *Annals of Emergency Medicine*. 2001; 38(1):8-11
- 402 Poon WS, Li AK. Comparison of management outcome of primary and secondary referred patients with traumatic extradural haematoma in a neurosurgical unit. *Injury*. 1991; 22(4):323-325
- 403 Porchet F. Acute management of mild traumatic brain injury. *Schweizer Archiv Fur Neurologie Und Psychiatrie*. 1998; 149(2):68-72
- 404 Powell TJ, Collin C, Sutton K. A follow-up study of patients hospitalized after minor head injury. *Disability and Rehabilitation*. 1996; 18(5):231-237
- 405 Prowse SJ, Sloan J. NICE guidelines for the investigation of head injuries--an anticoagulant loop hole? *Emergency Medicine Journal*. Radiology Registrar, Radiology Department, University Hospital Aintree, Liverpool L9 7AL, UK. sjbprowse@gmail.com 2010; 27(4):277-278
- 406 Ptak T, Kihiczak D, Lawrason JN, Rhea JT, Sacknoff R, Godfrey RR et al. Screening for cervical spine trauma with helical CT: Experience with 676 cases. *Emergency Radiology*. 2001; 8(6):315-319
- 407 Purtill MA, Benedict K, Hernandez-Boussard T, Brundage SI, Kritayakirana K, Sherck JP et al. Validation of a prehospital trauma triage tool: a 10-year perspective. *Journal of Trauma*. 2008; 65(6):1253-1257

- 408 Quayle KS, Jaffe DM, Kuppermann N, Kaufman BA, Lee BC, Park TS et al. Diagnostic testing for acute head injury in children: when are head computed tomography and skull radiographs indicated? *Pediatrics*. 1997; 99(5):E11
- 409 Quintana M, Rodiles RE, Marti M, Fabra S, Borobia AM, Rivera MA et al. Head injury (TBI) light: Is it be worse antiplatelet or anticoagulation? *Intensive Care Medicine*. 2012; 38:S174
- 410 Ralston ME, Chung K, Barnes PD, Emans JB, Schutzman SA. Role of flexion-extension radiographs in blunt pediatric cervical spine injury. *Academic Emergency Medicine*. 2001; 8(3):237-245
- 411 Rao N, Rosenthal M, Cronin-Stubbs D, Lambert R, Barnes P, Swanson B. Return to work after rehabilitation following traumatic brain injury. *Brain Injury*. 1990; 4(1):49-56
- 412 Reinus WR, Zwemer FLJ, Wippold FJ, Erickson KK. Emergency imaging of patients with resolved neurologic deficits: value of immediate cranial CT. *AJR American Journal of Roentgenology*. 1994; 163(3):667-670
- 413 Rendell S, Batchelor JS. An analysis of predictive markers for intracranial haemorrhage in warfarinised head injury patients. *Emergency Medicine Journal*. 2012;
- 414 Rethnam U, Yesupalan R, Gandham G. Does applying the Canadian Cervical Spine rule reduce cervical spine radiography rates in alert patients with blunt trauma to the neck? A retrospective analysis. *BMC Medical Imaging*. 2008; 8:12
- 415 Reynolds FD, Dietz PA, Higgins D, Whitaker TS. Time to deterioration of the elderly, anticoagulated, minor head injury patient who presents without evidence of neurologic abnormality. *Journal of Trauma*. 2003; 54(3):492-496
- 416 Richless LK, English K, Heller MB, Rachlin J, McClean P, Auble TE. A prospective evaluation of radiologic criteria for head injury patients in a community emergency department. *American Journal of Emergency Medicine*. 1993; 11(4):327-330
- 417 Rimel RW, Giordani B, Barth JT, Boll TJ, Jane JA. Disability caused by minor head injury. *Neurosurgery*. 1981; 9(3):221-228
- 418 Ro YS, Shin SD, Holmes JF, Song KJ, Park JO, Cho JS et al. Comparison of clinical performance of cranial computed tomography rules in patients with minor head injury: a multicenter prospective study. *Academic Emergency Medicine*. 2011; 18(6):597-604
- 419 Roberge RJ, Wears RC. Evaluation of neck discomfort, neck tenderness, and neurologic deficits as indicators for radiography in blunt trauma victims. *Journal of Emergency Medicine*. 1992; 10(5):539-544
- 420 Roberge RJ, Wears RC, Kelly M, Evans TC, Kenny MA, Daffner RD et al. Selective application of cervical spine radiography in alert victims of blunt trauma: a prospective study. *Journal of Trauma*. 1988; 28(6):784-788
- 421 Roddy SP, Cohn SM, Moller BA, Duncan CC, Gosche JR, Seashore JH et al. Minimal head trauma in children revisited: Is routine hospitalization required? *Pediatrics*. 1998; 101(4 Pt 1):575-577
- 422 Rodrigues D, Geraldo A, Pereira L, Antunes A, Monteiro V. Emergency CT scan in head injuries. *Neuroradiology*. 2011; 53(3):219

- 423 Romner B, Ingebrigtsen T, Kongstad P, Borgesen SE. Traumatic brain damage: serum S-100 protein measurements related to neuroradiological findings. *Journal of Neurotrauma*. 2000; 17(8):641-647
- 424 Rosenberg NM, Schweich PJ, Joffe M, Vinci RJ. Cervical spine injuries: to x-ray or not to x-ray? *Pediatric Emergency Care*. 1994; 10(1):48-50
- 425 Rosengren D, Rothwell S, Brown AFT, Chu K. The application of North American CT scan criteria to an Australian population with minor head injury. *Emergency Medicine Australasia: EMA*. 2004; 16(3):195-200
- 426 Rosenorn J, Duus B, Nielsen K, Kruse K, Boesen T. Is a skull X-ray necessary after milder head trauma? *British Journal of Neurosurgery*. 1991; 5(2):135-139
- 427 Ross SE, O'Malley KF, DeLong WG, Born CT, Schwab CW. Clinical predictors of unstable cervical spinal injury in multiply injured patients. *Injury*. 1992; 23(5):317-319
- 428 Roth BJ, Martin RR, Foley K, Barcia PJ, Kennedy P. Roentgenographic evaluation of the cervical spine. A selective approach. *Archives of Surgery*. 1994; 129(6):643-645
- 429 Royal College of Surgeons of England. Report of the working party on the management of patients with head injuries. London. Royal College of Surgeons of England, 1999
- 430 Royal College of Surgeons of England and British Orthopaedic Association. Better care for the severely injured. London. Royal College of Surgeons of England, 2000
- 431 Ruan S, Noyes K, Bazarian JJ. The economic impact of S-100B as a pre-head CT screening test on emergency department management of adult patients with mild traumatic brain injury. *Journal of Neurotrauma*. 2009; 26(10):1655-1664
- 432 Ruff RM, Crouch JA, Troster AI, Marshall LF, Buchsbaum MS, Lottenberg S et al. Selected cases of poor outcome following a minor brain trauma: comparing neuropsychological and positron emission tomography assessment. *Brain Injury*. 1994; 8(4):297-308
- 433 Ruff RM, Iverson GL, Barth JT, Bush SS, Broshek DK. Recommendations for diagnosing a mild traumatic brain injury: a National Academy of Neuropsychology education paper. *Archives of Clinical Neuropsychology : the Official Journal of the National Academy of Neuropsychologists*. 2009; 24(1):3-10
- 434 Saddison D, Vanek VW, Racanelli JL. Clinical indications for cervical spine radiographs in alert trauma patients. *American Surgeon*. 1991; 57(6):366-369
- 435 Salottolo K, Offner P, Levy AS, Mains CW, Slone DS, Bar-Or D. Interrupted pharmacologic thromboprophylaxis increases venous thromboembolism in traumatic brain injury. *Journal of Trauma - Injury, Infection and Critical Care*. 2011; 70(1):19-26
- 436 Saltzherr TP, Beenen LF, Reitsma JB, Luitse JS, Vandertop WP, Goslings JC. Frequent computed tomography scanning due to incomplete three-view X-ray imaging of the cervical spine. *Journal of Trauma-Injury Infection & Critical Care*. Trauma Unit Department of Surgery, Neurosurgical Center Amsterdam, Amsterdam, The Netherlands. t.p.saltzherr@amc.uva.nl 2010; 68(5):1213-1217

- 437 Sampalis JS, Denis R, Frechette P, Brown R, Fleiszer D, Mulder D. Direct transport to tertiary trauma centers versus transfer from lower level facilities: impact on mortality and morbidity among patients with major trauma. *Journal of Trauma*. 1997; 43(2):288-295
- 438 Sarani B, Waring S, Sonnad S, Schwab CW. Magnetic resonance imaging is a useful adjunct in the evaluation of the cervical spine of injured patients. *Journal of Trauma*. 2007; 63(3):637-640
- 439 Savastio G, Golfieri R, Pastore-Trossello M, Venturoli L. Cranial trauma: the predictability of the presentation symptoms as a screening for radiologic study. *Radiologia Medica*. 1991; 82(6):769-775
- 440 Schachar JL, Zampolin RL, Miller TS, Farinhas JM, Freeman K, Taragin BH. External validation of the New Orleans Criteria (NOC), the Canadian CT Head Rule (CCHR) and the National Emergency X-Radiography Utilization Study II (NEXUS II) for CT scanning in pediatric patients with minor head injury in a non-trauma center. *Pediatric Radiology*. 2011; 41(8):971-979
- 441 Schaller B, Evangelopoulos DS, Muller C, Martinolli L, Pouljadoff MP, Zimmermann H et al. Do we really need 24-h observation for patients with minimal brain injury and small intracranial bleeding? The Bernese trauma unit protocol. *Emergency Medicine Journal*. 2010; 27(7):537-539
- 442 Scharkowski P, Friedrich JM, Arand M, Mutschler W. Cervical spine injuries in head traumas: X-ray diagnosis on the day of the accident. *Rofo*. 1991; 154(6):605-609
- 443 Schenarts PJ, Diaz J, Kaiser C, Carrillo Y, Eddy V, Morris JA, Jr. Prospective comparison of admission computed tomographic scan and plain films of the upper cervical spine in trauma patients with altered mental status. *Journal of Trauma*. 2001; 51(4):663-668
- 444 Schiavi P, Iaccarino C, Servadei F. The value of the calcium binding protein S100 in the management of patients with traumatic brain injury. *Acta Biomedica*. 2012; 83(1):5-20
- 445 Schoenfeld AJ, Bono CM, McGuire KJ, Warholc N, Harris MB. Computed tomography alone versus computed tomography and magnetic resonance imaging in the identification of occult injuries to the cervical spine: a meta-analysis. *Journal of Trauma*. 2010; 68(1):109-114
- 446 Schoenwaelder M, MacLaurin W, Varma D. Assessing potential spinal injury in the intubated multitrauma patient: Does MRI add value? *Emergency Radiology*. 2009; 16(2):129-132
- 447 Schroder RJ, Vogl T, Hidajat N, Schedel H, Sudkamp N, Haas N et al. Comparison of the diagnostic value of CT and MRI in injuries of the cervical vertebrae. *Aktuelle Radiologie*. 1995; 5(4):197-202
- 448 Schunk JE, Rodgerson JD, Woodward GA. The utility of head computed tomographic scanning in pediatric patients with normal neurologic examination in the emergency department. *Pediatric Emergency Care*. 1996; 12(3):160-165
- 449 Schuster R, Waxman K. Is repeated head computed tomography necessary for traumatic intracranial hemorrhage? *American Surgeon*. 2005; 71(9):701-704
- 450 Schuster R, Waxman K, Sanchez B, Becerra S, Chung R, Conner S et al. Magnetic resonance imaging is not needed to clear cervical spines in blunt trauma patients with normal computed tomographic results and no motor deficits. *Archives of Surgery*. 2005; 140(8):762-766

- 451 Schwartz GR, Wright SW, Fein JA, Sugarman J, Pasternack J, Salhanick S. Pediatric cervical spine injury sustained in falls from low heights. *Annals of Emergency Medicine*. 1997; 30(3):249-252
- 452 Schynoll W, Overton D, Krome R, Wesolowski D, Wang AM, Wilson A et al. A prospective study to identify high-yield criteria associated with acute intracranial computed tomography findings in head-injured patients. *American Journal of Emergency Medicine*. 1993; 11(4):321-326
- 453 Scottish Intercollegiate Guidelines Network. Early management of patients with a head injury. Edinburgh. Scottish Intercollegiate Guidelines Network, 2000
- 454 Sees DW, Rodriguez Cruz LR, Flaherty SF, Ciceri DP. The use of bedside fluoroscopy to evaluate the cervical spine in obtunded trauma patients. *Journal of Trauma*. 1998; 45(4):768-771
- 455 Servadei F, Ciucci G, Laroni L, Cuscini M, Piola C, Arista A. Diagnosis and management of minor head injury: a regional multicenter approach in Italy. *Journal of Trauma*. 1995; 39(4):696-701
- 456 Servadei F, Faccani G, Roccella P, Seracchioli A, Godano U, Ghadirpour R et al. Asymptomatic extradural haematomas. Results of a multicenter study of 158 cases in minor head injury. *Acta Neurochirurgica*. 1989; 96(1-2):39-45
- 457 Servadei F, Teasdale G, Merry G. Defining acute mild head injury in adults: a proposal based on prognostic factors, diagnosis, and management. *Journal of Neurotrauma*. 2001; 18(7):657-664
- 458 Servadei F, Vergoni G, Nasi MT, Staffa G, Donati R, Arista A. Management of low-risk head injuries in an entire area: results of an 18-month survey. *Surgical Neurology*. 1993; 39(4):269-275
- 459 Servadei F, Vergoni G, Staffa G, Zappi D, Nasi MT, Donati R et al. Extradural haematomas: how many deaths can be avoided? Protocol for early detection of haematoma in minor head injuries. *Acta Neurochirurgica*. 1995; 133(1-2):50-55
- 460 Shaabat AO. Do we need to admit children with minor head injury? *Current Pediatric Research*. 2001; 5(1-2):27-29
- 461 Shackford SR, Wald SL, Ross SE, Cogbill TH, Hoyt DB, Morris JA et al. The clinical utility of computed tomographic scanning and neurologic examination in the management of patients with minor head injuries. *Journal of Trauma*. 1992; 33(3):385-394
- 462 Shane SA, Fuchs SM. Skull fractures in infants and predictors of associated intracranial injury. *Pediatric Emergency Care*. 1997; 13(3):198-203
- 463 Sharif-Alhoseini M, Khodadadi H, Chardoli M, Rahimi-Movaghar V. Indications for brain computed tomography scan after minor head injury. *Journal of Emergencies, Trauma, and Shock*. 2011; 4(4):472-476
- 464 Sharma M, Sharma AK. Mode, presentation, CT findings and outcome of pediatric head injury. *Indian Pediatrics*. 1994; 31(6):733-739
- 465 Sharma S, Singh M, Wani IH, Sharma S, Sharma N, Singh D. Adult Spinal Cord Injury without Radiographic Abnormalities (SCIWORA): Clinical and Radiological Correlations. *Journal of Clinical Medicine Research*. 2009; 1(3):165-172

- 466 Sheikh K, Belfi LM, Sharma R, Baad M, Sanelli PC. Evaluation of acute cervical spine imaging based on ACR Appropriateness Criteria[REGISTERED]. *Emergency Radiology*. 2012; 19(1):11-17
- 467 Shrivastav BP, Huseyin TS, Hynes KA. NICE guideline for the management of head injury: an audit demonstrating its impact on a district general hospital, with a cost analysis for England and Wales. *Emergency Medicine Journal: EMJ*. 2006; 23(2):109-113
- 468 Silver JM, McAllister TW, Arciniegas DB. Depression and cognitive complaints following mild traumatic brain injury. *American Journal of Psychiatry*. 2009; 166(6):653-661
- 469 Simon B, Letourneau P, Vitorino E, McCall J. Pediatric minor head trauma: indications for computed tomographic scanning revisited. *Journal of Trauma*. 2001; 51(2):231-237
- 470 Simons R, Brasher P, Taulu T, Lakha N, Molnar N, Caron N et al. A population-based analysis of injury-related deaths and access to trauma care in rural-remote Northwest British Columbia. *Journal of Trauma*. 2010; 69(1):11-19
- 471 Siracuse JJ, Robich MP, Gautam S, Kasper EM, Moorman DW, Hauser CJ. Antiplatelet agents, warfarin, and epidemic intracranial hemorrhage. *Surgery, Department of Surgery, Beth Israel Deaconess Medical Center, Harvard Medical School, Boston, MA 02215, USA*. 2010; 148(4):724-729
- 472 Smits M, Dippel DW, de Haan GG, Dekker HM, Vos PE, Kool DR et al. External validation of the Canadian CT Head Rule and the New Orleans Criteria for CT scanning in patients with minor head injury. *JAMA*. 2005; 294(12):1519-1525
- 473 Smits M, Dippel DW, de Haan GG, Dekker HM, Vos PE, Kool DR et al. Minor head injury: guidelines for the use of CT--a multicenter validation study. *Radiology*. 2007; 245(3):831-838
- 474 Smits M, Dippel DW, Steyerberg EW, de Haan GG, Dekker HM, Vos PE et al. Predicting intracranial traumatic findings on computed tomography in patients with minor head injury: the CHIP prediction rule. *Annals of Internal Medicine*. Erasmus MC-University Medical Center Rotterdam, Rotterdam, The Netherlands. 2007; 146(6):397-405
- 475 Smits M, Dippel DWJ, Nederkoorn PJ, Dekker HM, Vos PE, Kool DR et al. Minor head injury: CT-based strategies for management - A cost-effectiveness analysis. *Radiology*. 2010; 254(2):532-540
- 476 Society of British Neurological Surgeons. *Safe Neurosurgery 2000*. London. Society of British Neurological Surgeons, 1999
- 477 Sollid S, Munch EJ, Gilbert M, Ingebrigtsen T. Pre-and inter-hospital transport of severely head-injured patients in rural Northern Norway. *Journal of Neurotrauma*. 2003; 20(3):309-314
- 478 Spektor S, Agus S, Merkin V, Constantini S. Low-dose aspirin prophylaxis and risk of intracranial hemorrhage in patients older than 60 years of age with mild or moderate head injury: a prospective study. *Journal of Neurosurgery*. Department of Neurosurgery, Hadassah University Hospital, Jerusalem, Israel. 2003; 99(4):661-665
- 479 Stassen NA, Williams VA, Gestring ML, Cheng JD, Bankey PE. Magnetic resonance imaging in combination with helical computed tomography provides a safe and efficient method of cervical spine clearance in the obtunded trauma patient. *Journal of Trauma*. 2006; 60(1):171-177

- 480 Steigelman M, Lopez P, Dent D, Myers J, Corneille M, Stewart R et al. Screening cervical spine MRI after normal cervical spine CT scans in patients in whom cervical spine injury cannot be excluded by physical examination. *American Journal of Surgery*. 2008; 196(6):857-863
- 481 Stein SC. Management of minor closed head injury. *Neurosurgery Quarterly*. 1996; 6(2):108-115
- 482 Stein SC, Doolin EJ. Management of minor closed head injury in children and adolescents. *Pediatric Surgery International*. 1995; 10(7):465-471
- 483 Stein SC, Fabbri A, Servadei F. Routine serial computed tomographic scans in mild traumatic brain injury: when are they cost-effective? *Journal of Trauma*. United States 2008; 65(1):66-72
- 484 Stein SC, Fabbri A, Servadei F, Glick HA. A critical comparison of clinical decision instruments for computed tomographic scanning in mild closed traumatic brain injury in adolescents and adults. *Annals of Emergency Medicine*. Department of Neurosurgery, Hospital of the University of Pennsylvania, Philadelphia, PA 19106, USA. sherman.stein@uphs.upenn.edu 2009; 53(2):180-188
- 485 Stein SC, Ross SE. The value of computed tomographic scans in patients with low-risk head injuries. *Neurosurgery*. 1990; 26(4):638-640
- 486 Stein SC, Ross SE. Mild head injury: a plea for routine early CT scanning. *Journal of Trauma*. 1992; 33(1):11-13
- 487 Stein SC, Spettell C, Young G, Ross SE. Limitations of neurological assessment in mild head injury. *Brain Injury*. 1993; 7(5):425-430
- 488 Stein SC, Burnett MG, Glick HA. Indications for CT scanning in mild traumatic brain injury: A cost-effectiveness study. *Journal of Trauma*. 2006; 61(3):558-566
- 489 Stelfox HT, Velmahos GC, Gettings E, Bigatello LM, Schmidt U. Computed tomography for early and safe discontinuation of cervical spine immobilization in obtunded multiply injured patients. *Journal of Trauma*. 2007; 63(3):630-636
- 490 Stevens PK, Penprase B, Kepros JP, Dunneback J. Parental recognition of postconcussive symptoms in children. *Journal of Trauma Nursing*. 2010; 17(4):178-4
- 491 Stevenson MD, Oakley PA, Beard SM, Brennan A, Cook AL. Triage patients with serious head injury: results of a simulation evaluating strategies to bypass hospitals without neurosurgical facilities. *Injury*. 2001; 32(4):267-274
- 492 Stiell IG, Clement CM, McKnight RD, Brison R, Schull MJ, Rowe BH et al. The Canadian C-spine rule versus the NEXUS low-risk criteria in patients with trauma. *New England Journal of Medicine*. 2003; 349(26):2510-2518
- 493 Stiell IG, Clement CM, Rowe BH, Schull MJ, Brison R, Cass D et al. Comparison of the Canadian CT Head Rule and the New Orleans Criteria in patients with minor head injury. *JAMA*. 2005; 294(12):1511-1518
- 494 Stiell IG, Lesiuk H, Wells GA, Coyle D, McKnight RD, Brison R et al. Canadian CT head rule study for patients with minor head injury: methodology for phase II (validation and economic analysis). *Annals of Emergency Medicine*. 2001; 38(3):317-322

- 495 Stiell IG, Lesiuk H, Wells GA, McKnight RD, Brison R, Clement C et al. The Canadian CT Head Rule Study for patients with minor head injury: rationale, objectives, and methodology for phase I (derivation). *Annals of Emergency Medicine*. 2001; 38(2):160-169
- 496 Stiell IG, Wells GA. Methodologic standards for the development of clinical decision rules in emergency medicine. *Annals of Emergency Medicine*. 1999; 33(4):437-447
- 497 Stiell IG, Wells GA, Vandemheen K, Clement C, Lesiuk H, Laupacis A et al. The Canadian CT Head Rule for patients with minor head injury. *Lancet*. 2001; 357(9266):1391-1396
- 498 Stiell IG, Wells GA, Vandemheen K, Laupacis A, Brison R, Eisenhauer MA et al. Variation in ED use of computed tomography for patients with minor head injury. *Annals of Emergency Medicine*. 1997; 30(1):14-22
- 499 Stiell IG, Wells GA, Vandemheen KL, Clement CM, Lesiuk H, De Maio VJ et al. The Canadian C-spine rule for radiography in alert and stable trauma patients. *JAMA*. 2001; 286(15):1841-1848
- 500 Sturloni N, Laudizi L, Venuta A, Venturelli C, Bettelli F, Franceschini L. Head injuries in the pediatric emergency department: a 5-year experience at the Pediatric Clinic of Modena. *Pediatrica Medica e Chirurgica*. 1997; 19(1):43-48
- 501 Subaiya S, Roberts I, Komolafe E, Perel P. Predicting intracranial hemorrhage after traumatic brain injury in low and middle-income countries: A prognostic model based on a large, multi-center, international cohort. *BMC Emergency Medicine*. 2012; 12
- 502 Sun BC, Hoffman JR, Mower WR. Evaluation of a modified prediction instrument to identify significant pediatric intracranial injury after blunt head trauma. *Annals of Emergency Medicine*. 2007; 49(3):325
- 503 Taheri PA, Karamanoukian H, Gibbons K, Waldman N, Doerr RJ, Hoover EL. Can patients with minor head injuries be safely discharged home? *Archives of Surgery*. 1993; 128(3):289-292
- 504 Tauber M, Koller H, Moroder P, Hitzl W, Resch H. Secondary intracranial hemorrhage after mild head injury in patients with low-dose acetylsalicylate acid prophylaxis. *Journal of Trauma*. 2009; 67(3):521-525
- 505 Tavarez MM, Atabaki SM, Teach SJ. Acute evaluation of pediatric patients with minor traumatic brain injury. *Current Opinion in Pediatrics*. 2012; 24(3):307-313
- 506 Taylor K, Lymburner P, Challen J. Medical imaging in emergency medicine: Assessing the use of serial imaging to screen for delayed intracranial haemorrhage in patients on anticoagulant and antiplatelet therapy. *Journal of Medical Imaging and Radiation Oncology*. 2012; 56:146-147
- 507 Teasdale G, Jennett B. Assessment of coma and impaired consciousness. A practical scale. *Lancet*. 1974; 2(7872):81-84
- 508 Teasdale GM, Murray G, Anderson E, Mendelow AD, MacMillan R, Jennett B et al. Risks of acute traumatic intracranial haematoma in children and adults: implications for managing head injuries. *BMJ*. 1990; 300(6721):363-367
- 509 Tehranzadeh J, Bonk RT, Ansari A, Mesgarzadeh M. Efficacy of limited CT for nonvisualized lower cervical spine in patients with blunt trauma. *Skeletal Radiology*. 1994; 23(5):349-352

- 510 The Netherlands Organisation for Health Research and Development (ZonMw). Cost-effectiveness of decision rules for the use of CT for minimal head injury (Project record). 2005. Available from: <http://www.mrw.interscience.wiley.com/cochrane/clhta/articles/HTA-32005001320/frame.html>
- 511 Thomas M, Teece S. Towards evidence based emergency medicine: best BETs from Manchester Royal Infirmary. Computed tomography and the exclusion of upper cervical spine injury in trauma patients with altered mental state. *Emergency Medicine Journal*. 2002; 19(6):551-552
- 512 Thornhill S, Teasdale GM, Murray GD, McEwen J, Roy CW, Penny KI. Disability in young people and adults one year after head injury: prospective cohort study. *BMJ*. 2000; 320(7250):1631-1635
- 513 Tiesman H, Young T, Torner JC, McMahon M, Peek-Asa C, Fiedler J. Effects of a rural trauma system on traumatic brain injuries. *Journal of Neurotrauma*. 2007; 24(7):1189-1197
- 514 Tilt L, Babineau J, Fenster D, Ahmad F, Roskind CG. Blunt cervical spine injury in children. *Current Opinion in Pediatrics*. 2012; 24(3):301-306
- 515 Tomei G, Brambilla GL, Delfini R, Servadei F, Ambrosio A, Acampora S et al. Guidelines for minor head injured patients' management in adult age. *Journal of Neurosurgical Sciences*. 1996; 40(1):11-15
- 516 Tomycz ND, Chew BG, Chang YF, Darby JM, Gunn SR, Nicholas DH et al. MRI is unnecessary to clear the cervical spine in obtunded/comatose trauma patients: the four-year experience of a level I trauma center. *Journal of Trauma*. 2008; 64(5):1258-1263
- 517 Touger M, Gennis P, Nathanson N, Lowery DW, Pollack CV, Jr., Hoffman JR et al. Validity of a decision rule to reduce cervical spine radiography in elderly patients with blunt trauma. *Annals of Emergency Medicine*. 2002; 40(3):287-293
- 518 Toupin JM, Lechevallier J, Chaput E, Dacher JN, Le Dosseur P, Proust B et al. Selective indications of skull radiography after head injury in children. *Revue De Chirurgie Orthopedique Et Reparatrice De L Appareil Moteur*. 1996; 82(3):201-207
- 519 Tran B, Saxe JM, Ekeh A. Is flexion extension film necessary for cervical spine clearance in patient with neck pain after negative cervical CT scan? *Journal of Surgical Research*. 2013; 179(2)
- 520 Trauma Audit and Research Network (TARN). Procedures manual. Salford. The TRAUMA Audit & Research Network, 2012 Available from: <https://www.tarn.ac.uk/content/downloads/53/Procedures%20Dec%202012.pdf>
- 521 Tsai MC, Yang LH, Wu MH. Value of emergency room computed tomographic brain scan in mild head injury patients. *Journal Surgical Association Republic of China*. 1994; 27(2):2278-2282
- 522 Turner B, Fleming J, Cornwell P, Worrall L, Ownsworth T, Haines T et al. A qualitative study of the transition from hospital to home for individuals with acquired brain injury and their family caregivers. *Brain Injury*. 2007; 21(11):1119-1130
- 523 Turner BJ, Fleming JM, Ownsworth TL, Cornwell PL. The transition from hospital to home for individuals with acquired brain injury: a literature review and research recommendations. *Disability and Rehabilitation*. 2008; 30(16):1153-1176

- 524 Turner BJ, Fleming J, Ownsworth T, Cornwell P. Perceived service and support needs during transition from hospital to home following acquired brain injury. *Disability and Rehabilitation*. 2011; 33(10):818-829
- 525 Tyers A, McDowall J, Blyth T, Bond A. Patient education: mild traumatic brain injury... Occupational Therapy Australia, 24th National Conference and Exhibition, 29 June - 1 July 2011. *Australian Occupational Therapy Journal*. 2011; 58:14-15
- 526 Uchino Y, Okimura Y, Tanaka M, Saeki N, Yamaura A. Computed tomography and magnetic resonance imaging of mild head injury--is it appropriate to classify patients with Glasgow Coma Scale score of 13 to 15 as "mild injury"? *Acta Neurochirurgica*. 2001; 143(10):1031-1037
- 527 Viccellio P, Simon H, Pressman BD, Shah MN, Mower WR, Hoffman JR. A prospective multicenter study of cervical spine injury in children. *Pediatrics*. 2001; 108(2):E20
- 528 Vilke GM, Chan TC, Guss DA. Use of a complete neurological examination to screen for significant intracranial abnormalities in minor head injury. *American Journal of Emergency Medicine*. 2000; 18(2):159-163
- 529 Viola L, Zotta D, Martino V, Barbato R, Schisano G. Minor head injuries: one year experience according to the new Italian guideline. *Acta Neurochirurgica*. 2000; 142(11):1281-1285
- 530 Vos PE, Battistin L, Birbamer G, Gerstenbrand F, Potapov A, Prevec T et al. EFNS guideline on mild traumatic brain injury: report of an EFNS task force. *European Journal of Neurology*. 2002; 9(3):207-219
- 531 Wang MY, Griffith P, Sterling J, McComb JG, Levy ML. A prospective population-based study of pediatric trauma patients with mild alterations in consciousness (Glasgow Coma Scale score of 13-14). *Neurosurgery*. 2000; 46(5):1093-1099
- 532 West OC, Anbari MM, Pilgram TK, Wilson AJ. Acute cervical spine trauma: diagnostic performance of single-view versus three-view radiographic screening. *Radiology*. 1997; 204(3):819-823
- 533 Widder S, Doig C, Burrowes P, Larsen G, Hurlbert RJ, Kortbeek JB. Prospective evaluation of computed tomographic scanning for the spinal clearance of obtunded trauma patients: preliminary results. *Journal of Trauma*. 2004; 56(6):1179-1184
- 534 Williams J, Jehle D, Cottingham E, Shufflebarger C. Head, facial, and clavicular trauma as a predictor of cervical-spine injury. *Annals of Emergency Medicine*. 1992; 21(6):719-722
- 535 Wong DK, Lurie F, Wong LL. The effects of clopidogrel on elderly traumatic brain injured patients. *Journal of Trauma-Injury Infection & Critical Care*. Department of Surgery, University of Hawaii John A. Burns School of Medicine and Queens Medical Center, Honolulu, Hawaii, USA. 2008; 65(6):1303-1308
- 536 Woodring JH, Lee C. Limitations of cervical radiography in the evaluation of acute cervical trauma. *Journal of Trauma*. 1993; 34(1):32-39
- 537 Woods WA, Brady WJ, Pollock G, Kini N, Young JS, Swischuk LE. Flexion-extension cervical spine radiography in pediatric blunt trauma. *Emergency Radiology*. 1998; 5(6):381-384

- 538 Wuerz R, Taylor J, Smith JS. Accuracy of trauma triage in patients transported by helicopter. *Air Medical Journal*. 1996; 15(4):168-170
- 539 Yates KM, Pena A. Comprehension of discharge information for minor head injury: A randomised controlled trial in New Zealand. *New Zealand Medical Journal*. 2006; 119(1239)
- 540 Yuh EL, Mukherjee P, Lingsma HF, Yue JK, Ferguson AR, Gordon WA et al. Magnetic resonance imaging improves 3-month outcome prediction in mild traumatic brain injury. *Annals of Neurology*. 2012;
- 541 Zabel DD, Tinkoff G, Wittenborn W, Ballard K, Fulda G. Adequacy and efficacy of lateral cervical spine radiography in alert, high-risk blunt trauma patient. *Journal of Trauma*. 1997; 43(6):952-956
- 542 Zongo D, Ribereau-Gayon R, Masson F, Laborey M, Contrand B, Salmi LR et al. S100-B protein as a screening tool for the early assessment of minor head injury. *Annals of Emergency Medicine*. 2012; 59(3):209-218
- 543 Zurek J, Fedora M. The usefulness of S100B, NSE, GFAP, NF-H, secretagogin and Hsp70 as a predictive biomarker of outcome in children with traumatic brain injury. *Acta Neurochirurgica*. 2012; 154(1):93-103