

Single Technology Appraisal

Dabrafenib with trametinib for treating BRAF V600E mutation-positive glioma in children and young people aged 1 to 17 [ID5104]

Committee Papers

NATIONAL INSTITUTE FOR HEALTH AND CARE EXCELLENCE

SINGLE TECHNOLOGY APPRAISAL

**Dabrafenib with trametinib for treating BRAF V600E mutation-positive glioma
in children and young people aged 1 to 17 [ID5104]**

Contents:

The following documents are made available to stakeholders:

The [final scope and final stakeholder list](#) are available on the NICE website.

- 1. Company submission from Novartis Pharmaceuticals**
 - a. Company summary of information for patients (SIP)**
- 2. Clarification questions and company responses**
- 3. Patient group, professional group and NHS organisation submissions**
from:
 - a. The Brain Tumour Charity
- 4. Expert personal perspectives** from:
 - a. Prof. John-Paul Kilday, Paediatric Neuro-oncology Consultant –clinical expert, nominated by Novartis Pharmaceuticals
 - b. Dr Lynley Marshall, Consultant in Paediatric and Adolescent Oncology Drug Development – clinical expert, nominated by Novartis Pharmaceuticals
 - c. Sukhdip Sandhu – patient expert, nominated by The Brain Tumour Charity
 - d. Clare Jackson, Frontline Support Manager - patient expert, nominated by The Brain Tumour Charity
- 5. External Assessment Report** prepared by ScHARR
- 6. External Assessment Report – factual accuracy check**

Any information supplied to NICE which has been marked as confidential, has been redacted. All personal information has also been redacted.

NATIONAL INSTITUTE FOR HEALTH AND CARE EXCELLENCE

Single technology appraisal

Dabrafenib with trametinib for treating *BRAF* V600E mutation-positive glioma in children and young people aged 1 to 17 [ID5104]

Document B

Company evidence submission

October 2023

File name	Version	Contains confidential information	Date
ID5104_Dabrafenib plus trametinib_BRAFm glioma_Document B [Redacted]	2.0	Yes	23 rd October 2023

Contents

Abbreviations	5
List of tables.....	8
List of figures	10
B.1 Decision problem, description of the technology and clinical care pathway	12
B.1.1 Decision problem.....	13
B.1.2 Description of the technology being evaluated	17
B.1.3 Health condition and position of the technology in the treatment pathway	19
B.1.3.1 Disease overview	19
B.1.3.2 Pathophysiology	20
B.1.3.3 Epidemiology.....	21
B.1.3.4 Disease burden	22
B.1.3.5 Clinical pathway of care.....	24
B.1.3.6 Unmet need.....	27
B.1.4 Equality considerations.....	28
B.2 Clinical effectiveness	29
B.2.1 Identification and selection of relevant studies.....	31
B.2.2 List of relevant clinical effectiveness evidence.....	31
B.2.3 Summary of methodology of the relevant clinical effectiveness evidence	33
B.2.3.1 Study design	33
B.2.3.2 Doses of treatment	36
B.2.3.3 Inclusion and exclusion criteria.....	37
B.2.3.4 Concomitant therapies	38
B.2.4 Statistical analysis and definition of study groups in the relevant clinical effectiveness evidence	38
B.2.4.1 LGG cohort.....	38
B.2.4.2 HGG cohort.....	39
B.2.4.3 Secondary endpoints.....	40
B.2.4.4 Analysis sets	42
B.2.5 Critical appraisal of the relevant clinical effectiveness evidence	43
B.2.6 Clinical effectiveness results of the relevant studies	43
B.2.6.1 Patient disposition	43
B.2.6.2 Clinical effectiveness.....	49
B.2.7 Subgroup analysis.....	64
B.2.7.1 ORR, LGG cohort.....	64
B.2.8 Meta-analysis	65
B.2.9 Indirect and mixed treatment comparisons	65
B.2.9.1 Overview of the methodology	65
B.2.9.2 Evidence base.....	66
B.2.9.3 Identification of prognostic factors and treatment effect modifiers.....	67
B.2.9.4 Data extraction and variable generation	68
B.2.9.5 ITC analyses conducted.....	69
B.2.9.6 Results	72

B.2.9.7	Uncertainties in the indirect and mixed treatment comparisons	75
B.2.10	Adverse reactions.....	76
B.2.10.1	LGG cohort.....	76
B.2.10.2	HGG cohort.....	82
B.2.11	Ongoing studies	85
B.2.12	Interpretation of clinical effectiveness and safety evidence.....	86
B.2.12.1	TADPOLE and Study NCT02124772.....	86
B.2.12.2	Efficacy within the LGG cohort	86
B.2.12.3	Efficacy within the HGG cohort.....	87
B.2.12.4	Safety.....	88
B.3	Cost effectiveness.....	89
B.3.1	Published cost-effectiveness studies	90
B.3.1.1	Description of identified studies	90
B.3.2	Economic analysis.....	90
B.3.2.1	Patient population.....	90
B.3.2.2	Model structure	91
B.3.2.3	Model schematic	91
B.3.2.4	Health states and movement between health states.....	92
B.3.2.5	Model characteristics and justification	93
B.3.2.6	Model logic.....	94
B.3.2.7	Features of the economic analysis	95
B.3.2.8	Intervention technology and comparators.....	96
B.3.3	Clinical parameters and variables.....	99
B.3.3.1	Baseline characteristics.....	100
B.3.3.2	Progression-free survival (first treatment) for LGG	101
B.3.3.3	PFS in patients with HGG.....	106
B.3.3.4	Time to death (glioma-related cause) following first progression	108
B.3.3.5	PFS for subsequent progression events/lines of treatment, LGG analysis	113
B.3.3.6	Time-to-treatment discontinuation due to AEs	115
B.3.3.7	UK life tables	116
B.3.3.8	Incidence of adverse events.....	117
B.3.3.9	Rate of malignant transformation.....	118
B.3.3.10	Survival following malignant transformation.....	118
B.3.4	Measurement and valuation of health effects	120
B.3.4.1	Health-related quality-of-life data from clinical trials.....	120
B.3.4.2	Mapping	120
B.3.4.3	Health-related quality of life studies	120
B.3.4.4	Adverse events	120
B.3.4.5	Health-related quality-of-life data used in the cost-effectiveness analysis.	121
B.3.5	Cost and healthcare resource use identification, measurement and valuation .	124
B.3.5.1	Intervention and comparators' costs and resource use.....	125
B.3.5.2	Healthcare resource use and costs	130
B.3.5.3	Adverse reaction unit costs and resource use	134
B.3.6	Severity	135

B.3.7	Uncertainty	136
B.3.8	Summary of base-case analysis inputs and assumptions.....	138
B.3.8.1	Summary of base-case analysis inputs	138
B.3.8.2	Assumptions.....	140
B.3.9	Base-case results.....	146
B.3.9.1	Base-case incremental cost-effectiveness analysis results.....	146
B.3.10	Exploring uncertainty	149
B.3.10.1	Probabilistic sensitivity analysis.....	149
B.3.10.2	Deterministic sensitivity analysis	151
B.3.10.3	Scenario analysis	154
B.3.11	Benefits not captured in the QALY calculation.....	154
B.3.12	Validation	155
B.3.12.1	Validation of cost-effectiveness analysis	155
B.3.13	Interpretation and conclusions of economic evidence.....	156
Appendices	159
References	160

Abbreviations

Abbreviation	Definition
AE	Adverse event
AiC	Academic in confidence
AIC	Akaike information criterion
BIC	Bayesian information criterion
BNF	British National Formulary
BOR	Best overall response
BRAF	V-raf murine sarcoma viral oncogene homolog B
BRAFm	<i>BRAF</i> -mutated
BSA	Body surface area
C	Carboplatin
CBR	Clinical benefit rate
CCLG	Children's Cancer and Leukaemia group
CCNU	Lomustine
CDKN2A	Cyclin dependent kinase inhibitor 2A
CE	Cost-effectiveness
CEAC	Cost-effectiveness acceptability curves
CI	Confidence interval
CNS	Central nervous system
CR	Complete response
CRF	Case report form
D	Dabrafenib
DMG	Diffuse midline glioma
DSA	deterministic sensitivity analyses
DSU	Decision Support Unit
eCRF	Electronic case report form
EFS	Event-free survival
EMA	European Medicines Agency
eMIT	Electric Market Information Tool
EORTC-QLQ-BN20	European Organisation for Research and Treatment of Cancer – Quality of life of Cancer Patients – Brain
EORTC-QLQ-C30	European Organisation for Research and Treatment of Cancer – Quality of life of Cancer Patients
EQ-5D	EuroQol five-dimensions
ERK	Extracellular signal-regulated kinase
ESMO	European Society for Medical Oncology
EU	European Union
EUR	Euros
FAS	Full analysis set
FDA	US Food and Drug Administration
GBP	Great British Pounds
GPOH	Society of Paediatric Oncology and Haematology
HCRU	Healthcare resource use
HR	Hazard ratio
HRG	Healthcare Resource Group

Abbreviation	Definition
HGG	High-grade glioma
HRQoL	Health-related quality of life
HSUV	Health state utility value
ICER	incremental cost-effectiveness ratio
IPD	Individual patient data
IV	Intravenous
KM	Kaplan-Meier
KPS/LPS	Karnofsky/Lansky performance score
LGG	Low-grade glioma
LS	Least squares
MAPK	Mitogen-activated protein kinase
MEK	Mitogen-activated protein kinase kinase
NCCN	National Comprehensive Cancer Network
NF1	Neurofibromatosis type 1
NHS	National Health Service
NICE	National Institute for Health and Care Excellence
OOP	Out-of-pocket
OR	Odds ratio
ORR	Objective response rate
OS	Overall survival
PD	Progressive disease
PFS	Progression-free survival
PPS	Post-progression survival
PR	Partial response
PROMIS	Patient Reported Outcomes Measurement Information Service
PSA	Probabilistic sensitivity analysis
PSM	Partitioned survival model
PSS	Personal Social Services
PSSRU	Personal Social Services Research Unit
QALY	Quality-adjusted life year
QoL	Quality of life
RANO	Response Assessment for Neuro-Oncology
RAS	Rat sarcoma virus
RDI	Relative dose intensity
SAE	Serious adverse event
SD	Stable disease
SGK1	Serum and glucocorticoid-regulated kinase 1
sHGG	Secondary high-grade glioma
SIOP-E-BTG	The International Society of Paediatric Oncology – Europe – Brain tumour group
SLR	Systematic literature review
SmPC	Summary of product characteristics
SoC	Standard-of-care
T	Trametinib
TMZ	Temozolomide
TSD	Technical Support Document

Abbreviation	Definition
TTO	Time trade-off
UK	United Kingdom
US	United States
USD	United States Dollars
V	Vincristine
WBC	White blood cell
WHO	World Health Organization
WTP	Willingness-to-pay
YPLL	Years of potential life lost

List of tables

Table 1: The decision problem	14
Table 2: Technology being evaluated.....	17
Table 3: Clinical effectiveness evidence.....	32
Table 4: Inclusion and exclusion criteria, TADPOLE	37
Table 5: Secondary endpoints for LGG and HGG cohorts.....	40
Table 6: Analysis sets, TADPOLE.....	42
Table 7: Patient disposition within analysis sets, LGG cohort.....	43
Table 8: Demographics and baseline disease characteristics, FAS-LGG	44
Table 9: Demographics and baseline disease characteristics, FAS-HGG	47
Table 10: Independent reviewer-assessed ORR using RANO criteria, FAS-LGG	50
Table 11: Investigator assessed-ORR using RANO criteria, FAS-LGG	51
Table 12: TADPOLE summary of DOR based on independent review and	51
Table 13: Kaplan-Meier estimates of PFS based on independent review and Investigator assessment by RANO criteria, FAS-LGG.....	53
Table 14: PROMIS Parent Proxy Global Health – Repeated measures analysis, FAS-LGG	56
Table 15: Independent reviewer-assessed ORR using RANO criteria, FAS-HGG	58
Table 16: Investigator assessed ORR using RANO criteria, FAS-HGG.....	59
Table 17: Kaplan-Meier estimates of DOR by independent review and Investigator assessment based on RANO criteria, FAS-HGG	59
Table 18: Kaplan-Meier estimates of PFS per independent review and Investigator assessment based on RANO criteria, FAS-HGG	62
Table 19: Kaplan-Meier estimates of OS, FAS-HGG.....	63
Table 20: Summary of studies included in the ITC analyses	66
Table 21: Availability of prognostic factors in HGG in the included studies	68
Table 22: Baseline characteristics of included studies.....	68
Table 23: ITC analyses conducted	70
Table 24: Comparison of baseline characteristics (TMZ-naïve subgroup): MAIC D+T (TADPOLE) vs TMZ (Verschuur 2004).....	72
Table 25: Summary of OS MAIC (TMZ-naïve subgroup): D+T (TADPOLE) vs TMZ (Verschuur 2004)	73
Table 26: Comparison of baseline characteristics (TMZ-naïve subgroup): IPTW D+T (TADPOLE) vs TMZ (Verschuur 2004).....	73
Table 27: Summary of PFS IPTW (TMZ-naïve subgroup): D+T (TADPOLE) vs TMZ (Verschuur 2004)	74
Table 28: Overview of AEs, Safety set-LGG	77
Table 29: Adverse events (occurring in $\geq 30\%$ of patients in either group) by PT, Safety set- LGG	78
Table 30: Adverse events suspected to be related to study drug (occurring in $\geq 30\%$ of patients in either group) by PT, Safety set-LGG	79
Table 31: Serious AEs by preferred term, occurring in over 3% of patients, Safety set-LGG	80
Table 32: Adverse events leading to discontinuation of study treatment by PT, Safety set- LGG	81
Table 33: Overview of AEs, Safety set-HGG.....	82
Table 34: Adverse events (occurring in $\geq 15\%$ of patients) by PT, Safety set-HGG.....	83

Table 35: Adverse events suspected to be related to the study drug (occurring	83
Table 36: Serious adverse events by PT (occurring in $\geq 3\%$ of patients), Safety set-HGG ...	84
Table 37: Ongoing studies of dabrafenib with trametinib in paediatric gliomas	85
Table 38: Features of the economic analysis	95
Table 39: European schedule (SIOP-LGG-2004 protocol (89)) for vincristine & carboplatin (Reproduction of Figure 3 in CCLG guidelines) assumed in the economic model	98
Table 40: Summary of sources of data used in the economic model.....	99
Table 41: Baseline characteristics at entry	101
Table 42: Treatment effect assumed in the economic analysis (scenario analysis only)....	105
Table 43: Treatment effects assumed in the economic analysis for the HGG analysis	108
Table 44: Incidence of Grade 3/4 adverse events used in the economic analysis	117
Table 45: Summary of utility values for cost-effectiveness analysis.....	124
Table 46: Summary of treatment costs used in the economic model.....	126
Table 47: Drug administration costs	129
Table 48: Unit costs	130
Table 49: On treatment monitoring assumed in the economic model.	131
Table 50: Treatment modalities given following progression [†]	132
Table 51: Unit costs used for BSC	133
Table 52: Adverse events costs	134
Table 53: Summary of QALY shortfall analysis	136
Table 54: Summary features of QALY shortfall analysis.....	136
Table 55: Summary of health state benefits for QALY shortfall analysis.....	136
Table 56: Summary of variables applied in the economic model.	138
Table 57: List of assumptions for the base-case analysis model	140
Table 58: Base-case incremental cost-effectiveness results (PAS price)	146
Table 59: Net health benefits (PAS price)	147
Table 60: PSA results (PAS price)	149

List of figures

Figure 1: Molecular pathways involved in paediatric gliomas	20
Figure 2: MAPK signalling pathway with and without <i>BRAF</i> alterations	21
Figure 3: Proposed positioning of dabrafenib + trametinib for the treatment of <i>BRAF</i> V600E mutation-positive paediatric gliomas	26
Figure 4: Study design for LGG cohort.....	34
Figure 5: Study design for the HGG cohort	35
Figure 6: Kaplan-Meier plot of DOR by independent review and using RANO criteria, FAS-LGG	52
Figure 7: Kaplan-Meier plot of DOR by Investigator assessment and using RANO criteria, FAS-LGG	53
Figure 8: Kaplan-Meier plot of PFS based on independent review and using RANO criteria, FAS-LGG	54
Figure 9: Kaplan- Meier plot of PFS based on Investigator assessment and	55
Figure 10: Kaplan-Meier plot of DOR by independent review based on RANO criteria, FAS-HGG	60
Figure 11: Kaplan-Meier plot of DOR by Investigator assessment based on RANO criteria, FAS-HGG	61
Figure 12: Kaplan-Meier plot of PFS per independent review based on RANO criteria, FAS-HGG	62
Figure 13: Kaplan-Meier plot of PFS per Investigator assessment based on RANO criteria, FAS-HGG	63
Figure 14: Kaplan-Meier plot of OS, FAS-HGG	64
Figure 15: Forest plot of ORR odds ratio by independent assessment by subgroups, FAS-LGG	65
Figure 16: Kaplan-Meier plot for OS MAIC (TMZ-naïve subgroup): D+T matched with TMZ patient characteristics (Verschuur 2004)	73
Figure 17: Kaplan-Meier plot for PFS IPTW (TMZ-naïve subgroup): D+T matched with TMZ patient characteristics (Verschuur 2004)	74
Figure 18: Simplified model structure schematic	92
Figure 19: Hypothetical patients	95
Figure 20: Age and gender distribution assumed in the economic model	101
Figure 21: Kaplan-Meier curve for PFS evaluated by investigator review	103
Figure 22: Extrapolation approach for PFS for LGG (hypothetical patient)	105
Figure 23: Kaplan-Meier curve for PFS for D+T measured by local assessment, HGG analysis	106
Figure 24: Comparison of the KM and extrapolation method for D+T, PFS HGG	107
Figure 25: Survival probabilities for early (<18 month) and late progressors (≥18 months) used in the economic analysis, LGG	109
Figure 26: KM plot for the time to death following D+T discontinuation and/or start of anti-neoplastic therapy	110
Figure 27: Comparison of the KM and parametric fit for PPS	111
Figure 28: Comparison of the KM for PPS for D+T and OS from MacDonald 2013 and Narayana 2010	113
Figure 29: PFS assumed in subsequent lines of treatment/ progression	114

Figure 30: KM for the time to treatment discontinuation due to reasons other than progression	115
Figure 31: Comparison of the KM and parametric for parametric distribution fit for TTD for D+T	116
Figure 32: Comparison of the survival taken from national life tables and Gompertz fit	116
Figure 33: Comparison of the KM and parametric distribution fit for EFS following malignant transformation	119
Figure 34: Background EQ-5D in people without the condition (general population – healthy adults)	121
Figure 35: Administration schedule for chemotherapies assumed in the economic model for LGG [†]	127
Figure 36: Dose assumed in the economic model for D+T according to age and gender for LGG and HGG analysis	128
Figure 37: PSA cost-effectiveness plane and CEAC (PAS price)	150
Figure 38: Tornado diagram based on DSA results (PAS price)	152
Figure 39: Scenario analysis results (PAS price)	153

B.1 Decision problem, description of the technology and clinical care pathway

In the United Kingdom (UK), malignancies affecting the brain and central nervous system (CNS) are the second most common type of cancer, and the most common cause of cancer-related death in children (1, 2)

- Gliomas are a group of histologically distinct brain tumours originating from glial cells, and account for almost half of all brain and CNS tumours in children and adolescents aged 0–19 years (3, 4)
- Among CNS tumours, gliomas represent nearly 50% of all solid paediatric CNS tumours and are a major cause of cancer-associated deaths (4, 5)
- Paediatric gliomas are divided into low-grade (LGG) and high-grade gliomas (HGG), which are further classified into World Health Organization (WHO) Grades I–IV (LGG: Grade I–II; HGG: Grade III–IV) (6–8)
- There are about 150 cases of LGG and 30 cases of HGG diagnosed per year in the UK (13, 14)
- Among congenital infant/children groups, LGG is the most common subtype, accounting for approximately 80% of all glioma cases (9), and is characterised by low proliferative potential or low-level proliferative activity, although Grade II tumours often recur (6)
- HGG is an aggressive subtype of glioma, with Grade IV tumours typically associated with rapid pre- and post-operative disease evolution (6)
- Mutations in the v-raf murine sarcoma viral oncogene homolog B (*BRAF*) gene, which encodes the protein kinase BRAF, are the most common genetic alterations in paediatric gliomas (10), and occur in 7–15% of tumours (11, 12)

Paediatric gliomas are associated with significant clinical, humanistic, and economic burden

- Symptoms of paediatric glioma include nausea and vomiting, lethargy, irritability, headaches, clumsiness, seizures, changes in personality and behaviour, and abnormal gait (13, 14)
- HGG is associated with poor survival rates, with 5-year survival rates of <10% for patients with Grade IV glioma. In contrast, patients with LGG Grade I tumours have 5-year survival rates of up to 95% (15, 16)
- In paediatric LGG, *BRAF* alterations are associated with poor prognosis (15). *BRAF* V600 mutations are associated with poor outcomes post-radiation and conventional chemotherapy (11), and with an increased risk of transformation to HGG compared with *BRAF* wild-type tumours (17)
- Brain cancer poses a notable burden on the health-related quality of life (HRQoL) of patients, who experience poorer physical health, decreased psychosocial health, emotional functioning, and social functioning (18)

- As adults, survivors of childhood brain tumours are at an increased risk of unemployment, and cognitive, motor, and psychological-emotional impairments (18)
- Within the UK, brain cancer is associated with high direct medical costs, with an average inpatient, post-diagnosis cost of £13,200. For patients with a high-grade tumour, the approximate direct medical cost for a year is estimated at £180,000 (19)

The combination of dabrafenib with trametinib (D+T) represents a novel targeted treatment option for patients with *BRAF* V600E mutation-positive LGG, and relapsed or refractory HGG

- Patients with *BRAF* mutation-positive LGG treated with conventional therapies have poor outcomes compared with those with *BRAF* wild-type tumours (20). Additionally, paediatric patients with LGG may experience long-term neurological, treatment-related morbidities (21)
- There is a lack of treatment options for paediatric HGG, with chemotherapy offering limited benefit and associated with burdensome toxicity (22)
- Dabrafenib with trametinib is indicated for patients aged 1 to 17 years with *BRAF* V600E mutation-positive glioma
- Dabrafenib and trametinib are both administered orally, offering a more convenient mode of administration compared with standard-of-care (SoC) chemotherapies carboplatin and vincristine, which are administered intravenously (23, 24). The liquid dosage forms also allow for accurate body weight-adjusted dosing in paediatric patients and may represent a better mode of administration, as young children are unable to swallow tablets/capsules. The combination of D+T may improve tolerability amongst older children
- The availability of an oral treatment option has a positive impact on alleviating capacity issues within the National Health Service (NHS), while oral alternatives to intravenous therapies also represent an important preference for patients (25)

There are no other treatments for *BRAF*-mutated patients and therefore, the availability of D+T may address a significant unmet clinical need

B.1.1 Decision problem

The objective of this appraisal is to determine the clinical and cost-effectiveness of dabrafenib plus trametinib (D+T) in line with its marketing authorisation, for the treatment of children and young people with *BRAF* V600E mutation-positive glioma. The submission covers the technology's full marketing authorisation for this indication. The decision problem addressed in this submission is provided in Table 1, which outlines any differences from the NICE final scope (26).

Table 1: The decision problem

	Final scope issued by NICE	Decision problem addressed in the company submission	Rationale if different from the final NICE scope
Population	Children and young people with <i>BRAF</i> V600E mutation-positive glioma: <ul style="list-style-type: none"> • Low-grade glioma that requires systemic treatment • High-grade glioma that has relapsed, progressed or failed to respond to previous systemic treatment 	As per final scope	N/A – in line with the NICE final scope
Intervention	Dabrafenib with trametinib	As per final scope	N/A – in line with the NICE final scope
Comparator(s)	For children and young people with low-grade glioma: <ul style="list-style-type: none"> • Chemotherapy (including but not limited to vincristine with carboplatin) For children and young people with high-grade glioma: <ul style="list-style-type: none"> • Chemotherapy • Best supportive care 	<p>LGG cohort:</p> <ul style="list-style-type: none"> • Carboplatin with vincristine <p>HGG cohort:</p> <ul style="list-style-type: none"> • Temozolomide (TMZ) (in patients not previously treated to TMZ) • Best supportive care (in patients previously treated with TMZ) 	<p>LGG cohort:</p> <p>Cost-effectiveness evidence focusses on <i>BRAF</i> V600E-mutant LGG with progressive disease following surgical excision, or non-surgical candidates with necessity to begin first systemic treatment based on the population recruited in the TADPOLE study. Carboplatin with vincristine is the recommended first-line chemotherapy for LGG as per the UK CCLG guideline (27) and confirmed by clinical experts (28, 29)</p> <p>HGG cohort:</p> <p>There are no guidelines on the recommended chemotherapy regimen to treat patients with HGG who are relapsed/refractory. TMZ is the only chemotherapy with an EU marketing authorisation in children aged ≥ 3 years and young adults with relapsed or refractory malignant glioma (30). However, many patients receive TMZ in the adjuvant setting (31). To date, no other chemotherapy has been shown to be effective in the recurrent setting and therefore patients would typically receive BSC/palliative care (32)</p>

Company evidence submission template for dabrafenib with trametinib for treating *BRAF* V600E mutation-positive glioma in children and young people aged 1 to 17 [ID5104]

	Final scope issued by NICE	Decision problem addressed in the company submission	Rationale if different from the final NICE scope
Outcomes	<p>The outcome measures to be considered include:</p> <ul style="list-style-type: none"> • OS • PFS • DOR • Response rates • AEs of treatment • Health-related quality of life (of patients and carers) 	As per final scope	N/A – in line with the NICE final scope
Economic analysis	<p>The reference case stipulates that the cost effectiveness of treatments should be expressed in terms of incremental cost per quality-adjusted life year.</p> <p>The reference case stipulates that the time horizon for estimating clinical and cost effectiveness should be sufficiently long to reflect any differences in costs or outcomes between the technologies being compared.</p> <p>Costs will be considered from an NHS and Personal Social Services perspective.</p> <p>The availability of any commercial arrangements for the intervention, comparator and subsequent treatment technologies will be taken into account.</p> <p>The use of dabrafenib with trametinib is conditional on the presence of <i>BRAF</i> V600E mutation. The economic modelling</p>	As per the NICE reference case	<p>N/A – in line with the NICE final scope</p> <p>In order to initiate treatment with D+T, patients must have confirmation of a <i>BRAF</i> V600 mutation using a validated test. In England, patients diagnosed with Glioma are routinely tested for common driver mutations, including <i>BRAF</i> V600 mutations, via NGS panel testing.</p> <p>As such, identifying patients with <i>BRAF</i> V600 mutation-positive glioma would not result in any additional testing costs associated with the introduction of D+T</p>

	Final scope issued by NICE	Decision problem addressed in the company submission	Rationale if different from the final NICE scope
	should include the costs associated with diagnostic testing for <i>BRAF</i> V600E in people with glioma who would not otherwise have been tested. A sensitivity analysis should be provided without the cost of the diagnostic test.		
Subgroups to be considered	LGG that requires systemic treatment HGG that has relapsed, progressed or failed to respond to previous systemic treatment	As per final scope	N/A – in line with the NICE final scope

Abbreviations: AE, adverse event; BRAF, v-raf murine sarcoma viral oncogene homolog B; BSC, best supportive care; CCLG, Children's Cancer and Leukaemia group; D, dabrafenib; DOR, duration of response; EU, European Union; HGG, high-grade glioma; HRQoL, health-related quality of life; LGG, low-grade glioma; N/A, not applicable; NICE, National Institute for Health and Care Excellence; ORR, overall response rate; OS, overall survival; PFS, progression-free survival; T, trametinib; TMZ, temozolomide.

B.1.2 Description of the technology being evaluated

The technology being appraised in this submission is described in Table 2.

The draft summary of product characteristics (SmPC) (33, 34) is provided in Appendix C.

Table 2: Technology being evaluated

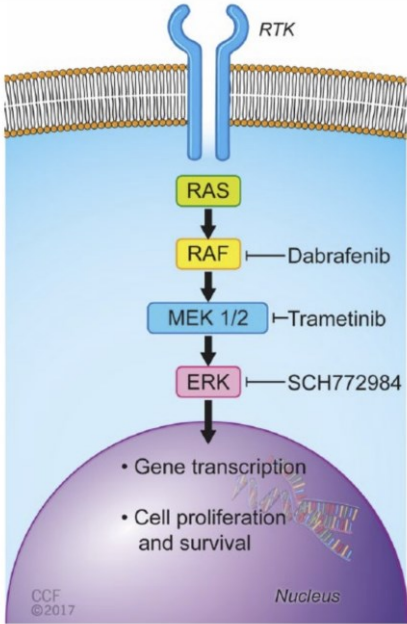
UK approved name and brand name	Dabrafenib (Finlee®) plus trametinib (Spexotras®)
Mechanism of action	<p>Dabrafenib is a potent, selective RAF kinase inhibitor, with 5–10-fold greater potency for inhibiting mutant <i>BRAF</i> V600 over wild-type <i>BRAF</i>. Dabrafenib inhibits cell proliferation via cell cycle arrest in G1; inducing cell death. Trametinib is an allosteric, selective inhibitor of MEK1 and MEK2, with activity in <i>BRAF</i> and <i>RAS</i> mutant cancer cell lines. It inhibits ERK phosphorylation leading to G1 cell cycle arrest and tumour growth inhibition. Since both <i>BRAF</i> and MEK act within the same pathway, and MEK is a substrate of activated <i>BRAF</i>, inhibiting both proteins simultaneously rather than individually is expected to provide a more selective pathway inhibition and improved efficacy, as well as address resistance to a <i>BRAF</i> or MEK inhibitor alone (35, 36)</p> <p>Mechanism of action of BRAF and MEK inhibitors</p>  <p>Source: Khunger 2018 (37)</p>
Marketing authorisation/CE mark status	<p>The planned indication for dabrafenib (Finlee®) and trametinib (Spexotras®) is:</p> <ul style="list-style-type: none"> • Low-grade glioma – Dabrafenib in combination with trametinib is indicated for the treatment of paediatric patients aged 1 year and older with low-grade glioma with a <i>BRAF</i> V600E mutation who require systemic therapy

	<ul style="list-style-type: none"> High-grade glioma – Dabrafenib in combination with trametinib is indicated for the treatment of paediatric patients aged 1 year and older with high-grade glioma with a <i>BRAF</i> V600E mutation who have received at least one prior radiation and/or chemotherapy treatment <p>A marketing authorisation application for dabrafenib (Finlee®) and trametinib (Spexotras®) in this indication was submitted to the EMA in September 2022; a positive opinion (PO) from the CHMP is anticipated in November 2023 for Spexotras®, however Finlee® received PO on the 14th of September 2023 (38). European commission (EC) decision is therefore expected January 2024 for trametinib and November 2023 for dabrafenib, with MHRA approval mirroring these timelines</p>
Indications and any restriction(s) as described in the summary of product characteristics (SmPC)	<p>The indication being appraised is for the liquid formulation of dabrafenib and trametinib.</p> <p>Trametinib (Mekinist®) and dabrafenib (Tafinlar®), as film coated tablets and hard capsules, respectively, have marketing authorisations in the UK, as monotherapies or as a combination therapy for the adjuvant treatment of melanoma, unresectable or metastatic melanoma, or NSCLC with a <i>BRAF</i> V600 mutation</p>
Method of administration and dosage	<p>Dabrafenib plus trametinib, are administered orally and are dosed based on weight:</p> <ul style="list-style-type: none"> Dabrafenib paediatric oral suspension formulation (10 mg dispersible tablets for oral suspension) is administered using a dosing cup and/or graduated syringe Trametinib paediatric oral solution formulation (5.0 mg powder for oral solution reconstituted to 0.05 mg/mL with 90 mL water) is to be administered with a graduated syringe <p>The management of adverse reactions may require treatment interruption, dose reduction or treatment discontinuation, as detailed in the SmPCs (33, 34)</p>
Additional tests or investigations	<p>In order to initiate treatment with dabrafenib and trametinib, patients must have confirmation of a <i>BRAF</i> V600 mutation using a validated test. In England, patients diagnosed with glioma are routinely tested for common driver mutations, including <i>BRAF</i> V600 mutations, via NGS panel testing.</p> <p>As such, the need to identify patients with glioma who harbour a <i>BRAF</i> V600 mutation would not result in any additional testing costs associated with the introduction of dabrafenib and trametinib</p>

List price and average cost of a course of treatment	The anticipated list prices for dabrafenib and trametinib are reported below:			
	Drug	Pack size	List price	Source
	Dabrafenib (Finlee®) 10 mg	420 sachets	██████████	Novartis
	Trametinib (Spexotras®) 4.7 mg	1 vial	██████████	Novartis
	The expected average cost of a course of treatment for dabrafenib and trametinib at list price is £██████████ for LGG, £██████████ for HGG not previous treated with TMZ and £██████████ for HGG previously treated with TMZ (reflecting a modelled mean of ██████ years, ██████ years and ██████ years on treatment respectively; Document B, Section B.3.9.1) This includes the relevant relative dose intensity reduction that patients might experience when receiving dabrafenib and trametinib based on the TADPOLE trial (39, 40)			
Patient access scheme (if applicable)	A confidential patient access scheme (PAS) discount has been proposed for dabrafenib of ██████% and ██████% for trametinib			

Abbreviations: BRAF, v-raf murine sarcoma viral oncogene homolog B; CE, conformité européenne; ERK, extracellular signal-regulated kinase; G1, growth 1 phase; MEK, mitogen-activated protein kinase kinase; MHRA, Medicines and Healthcare products Regulatory agency; NHS, National Health Service; NSCLC, non-small cell lung cancer; PAS, Patient Access Scheme; RAF, rapidly accelerated fibrosarcoma; RAS, rat sarcoma virus; SmPC, summary of product characteristics; UK, United Kingdom.

B.1.3 Health condition and position of the technology in the treatment pathway

B.1.3.1 Disease overview

Gliomas are a group of histologically distinct brain tumours that originate from glial cells, the supporting cells of the brain and central nervous system (CNS) (3). In children and adolescents aged 0–19 years, gliomas account for almost half of all brain and CNS tumours (4), and are therefore the most common type of brain cancers amongst children. In the UK, malignancies affecting the brain and CNS are the second most common type of cancer, and the most common cause of cancer-related death in children (1, 2).

Paediatric gliomas are classified by the World Health Organization (WHO) into Grade I–II (low-grade gliomas [LGG]) and Grade III–IV (high-grade gliomas [HGG]) (6-8). LGG is the most common subtype, accounting for approximately 80% of all glioma cases (9), and is characterised by low proliferative potential (WHO Grade I) or low-level proliferative activity (WHO Grade II) (6). The most common LGG subtypes are pilocytic astrocytomas and gangliogliomas (5, 10, 16). Paediatric LGG tumours typically harbour few genetic alterations, although alterations that may arise in LGG converge on the activation of the Rat sarcoma virus protein superfamily/mitogen-activated protein kinase (RAS/MAPK) pathway (20).

High-grade gliomas are less frequent, however carry a greater risk of mortality, accounting for over 40% of cancer-related deaths in children. HGG tumours display nuclear atypia and

brisk mitotic activity (Grade III), or are mitotically active, necrosis-prone neoplasms typically associated with rapid pre- and post-operative disease evolution (Grade IV) (6). The most common subtypes of HGG are anaplastic astrocytoma (Grade III) and glioblastoma multiforme (Grade IV) (14). Recent advances in sequencing have identified molecular aberrations associated with paediatric HGG, which can be divided into three distinct categories; histone 3 (*HIST3H3B*)-mutant, isocitrate dehydrogenase (*IDH*)-mutant, and *HIST3H3B/IDH*-wildtype/*BRAF*-mutant HGGs (41).

B.1.3.2 Pathophysiology

The development of paediatric gliomas is dependent on genetic alterations, cellular environment, and cell type. In recent years, a number of prognostic genetic anomalies have been identified that are predictive of tumour behaviour and may aid therapeutic decisions (15).

In paediatric patients, signalling pathways regulating mitotic activity, cell proliferation, and angiogenesis play a key role in glioma pathogenesis (15). Figure 1 summarises the signalling pathways involved in paediatric gliomas, in which extracellular signal-regulated kinases (ERK) and serum and glucocorticoid-regulated kinase 1 (SGK1) are activated downstream. ERK and SGK1 initiate nuclear gene transcription, leading to activation of pathways involved in cell division, proliferation, and malignant tumour behaviour (15).

Figure 1: Molecular pathways involved in paediatric gliomas

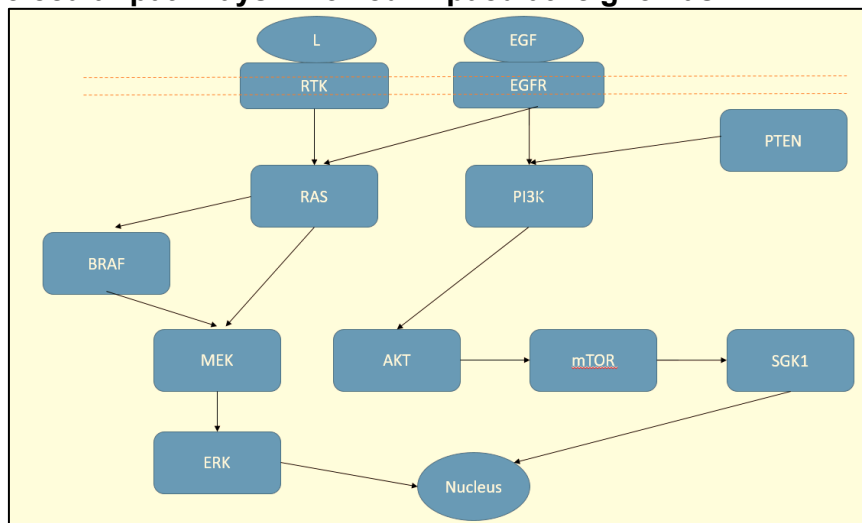

Source: Blionas 2018 (15)

Abbreviations: AKT, protein kinase B; BRAF, v-ras murine sarcoma viral oncogene homolog B; EGF, epidermal growth factor; EGFR, epidermal growth factor receptor; ERK, extracellular signal-regulated kinase; L, ligand; MEK, mitogen-activated protein kinase kinase; mTOR, mammalian target of rapamycin; PI3K, phosphatidylinositol-4,5-bisphosphate 3-kinase; PTEN, phosphatase and tensin homolog; RAS, RAS protein superfamily; RTK, probable serine/threonine-protein kinase; SGK1, serum and glucocorticoid-regulated kinase 1.

B.1.3.2.1 BRAF

The *BRAF* gene encodes the protein kinase BRAF, an important mediator of MAPK signalling via phosphorylation of MAPK kinase (MEK), and subsequently MAPK. Activating mutations of *BRAF* lead to the continuous downstream activation of the RAF-MEK-ERK

Company evidence submission template for dabrafenib with trametinib for treating *BRAF* V600E mutation-positive glioma in children and young people aged 1 to 17 [ID5104]

(MAPK) signalling cascade, promoting cell proliferation and eventually leading to tumourigenesis (Figure 2) (42).

Figure 2: MAPK signalling pathway with and without *BRAF* alterations

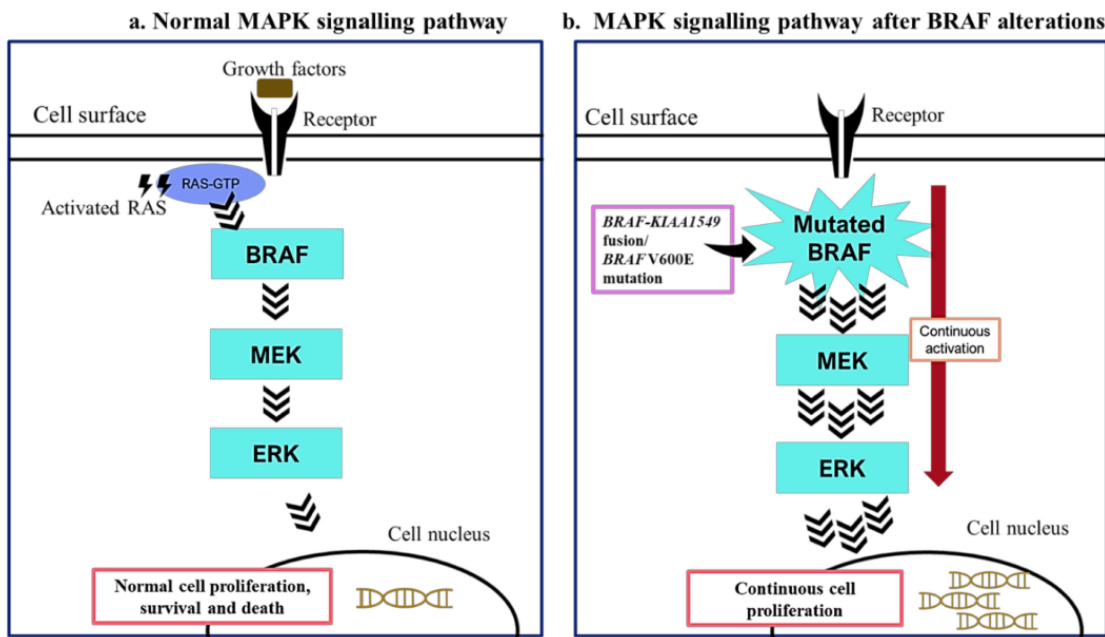

Abbreviations: BRAF, v-raf murine sarcoma viral oncogene homolog B; ERK, extracellular signal-regulated kinase; GTP, guanosine triphosphate; MAPK, mitogen-activated protein kinase; MEK, mitogen-activated protein kinase kinase; RAS, RAS protein superfamily.

Among *BRAF* alterations, the point mutation *BRAF V600E*¹, alongside fusion transcripts, are the most common genetic aberrations in paediatric gliomas, with the more common pilocytic astrocytoma and ganglioglioma frequently associated with *KIAA1549:BRAF* fusions and the *BRAF V600E* mutation, respectively (9). Paediatric LGGs tumours harbouring *BRAF V600E* have the poorest survival, particularly when co-occurring with cyclin dependent kinase inhibitor 2A (*CDKN2A*) homozygous deletion (29). Estimates for the prevalence of *BRAF V600* mutations in paediatric gliomas range from 7–15%, higher than in the adult population (4–9%) (10, 11).

B.1.3.3 Epidemiology

Brain tumours are the second most common type of childhood cancer in the UK, with around 420 children diagnosed with a CNS tumour each year. Paediatric LGG is the most prevalent childhood brain cancer (21); in the UK, there are about 150 cases of LGG, compared with fewer than 30 cases of HGG diagnosed per year (13, 14). Despite their rarity, HGGs account for over 40% of CNS tumour-related deaths in children aged 0–14 years old (5).

It is estimated that 15–20% of paediatric LGGs and 5–7% of HGGs harbour a *BRAF V600* mutation (11, 12, 20, 43). *BRAF V600* mutations are most prevalent in epithelioid

¹ The amino acid valine at position 600 is replaced with glutamic acid. Valine can also be substituted with other amino acids such as lysine (V600K), aspartic acid (V600D), or arginine (V600R), but these are less common.

glioblastoma (up to 69% of cases), followed by pleomorphic xanthoastrocytoma (56%), anaplastic ganglioglioma (46%) and ganglioglioma (40%) (11).

B.1.3.4 Disease burden

B.1.3.4.1 Clinical burden

The aetiology of glioma is unknown, but age, gender, exposure to ionising radiation, and environmental carcinogens may be associated with an increased risk of development (44). Symptoms of paediatric glioma include nausea and vomiting, lethargy, irritability, headaches, clumsiness, seizures, changes in personality and behaviour, and abnormal gait (13, 14). If the tumour spreads to or is located within the spinal cord, patients may experience back pain, difficulty in walking, and bowel and/or bladder incontinence (13, 14). Paediatric patients with unresectable LGG are vulnerable to chronic morbidities and functional impairment over prolonged periods, due to both tumour growth and the accumulation of treatment-related toxicities (45).

Paediatric patients with HGG have poorer overall survival (OS) compared with LGG, with 5-year survival rates of <10% in patients with Grade IV HGG compared with 95% for patients with Grade I LGG (15, 16). The presence of mutations can have a prognostic impact; mutations in *IDH1/2* and *HIST3H3B* can shift an otherwise lower grade tumour to a Grade IV classification (15). In paediatric patients with LGG, *BRAF* alterations are associated with a poor prognosis (15, 20, 46), with *BRAF* V600E mutations associated with poor outcomes after treatment with conventional therapies (20), and with an increased risk of transformation to HGG compared with LGG harbouring no genetic alterations (17). There are no data on the expected outcomes for patients with relapsed or refractory *BRAF* V600E mutant HGG who have failed initial treatment.

B.1.3.4.2 Humanistic burden

Paediatric CNS tumours pose a notable burden on the health-related quality of life (HRQoL) of patients, who experience poor physical health, decreased psychosocial health, emotional functioning, and social functioning (18). Additionally, children with LGG display greater anxiety and depression compared with children diagnosed with other brain cancers (47). As adults, survivors of childhood brain cancers are at an increased risk of unemployment, and are more likely to have cognitive, motor, and psychological-emotional impairments that may affect day-to-day activities (e.g. ability to drive) (18).

Brain and CNS tumours are associated with long-term morbidities and are responsible for the greatest loss in potential life-years in children and adolescents. Among all brain tumours, gliomas are associated with two-thirds of years of potential life lost (YPLL) (48). Surgery, radiation, and chemotherapy may lead to complications and treatment side-effects such as fatigue, anorexia, venous thromboembolic events, gastrointestinal perforation, and myelosuppression. Depressive symptoms and fatigue are associated with an increase in healthcare utilisation and reduced work productivity (49).

A study of paediatric patients with brain tumours using the Pediatric Quality of Life Inventory 4.0 and cancer module (PedsQL 4.0) to measure HRQoL reported that the overall HRQoL of

children with brain tumours was significantly lower than that of healthy participants. Patients with glioma scored the lowest in terms of psychosocial health, emotional functioning, and school functioning compared with other brain tumour types (18).

Another United States (US)-based study assessing the HRQoL of long-term survivors of paediatric LGG reported that (50):

- Radiation-treated patients reported lower physical functioning ($p=0.002$), role functioning ($p=0.004$), and more constipation problems ($p<0.001$) than non-irradiated patients, as measured using the European Organisation for Research and Treatment of Cancer – Quality of life of Cancer Patients (EORTC-QLQ-C30) questionnaire
- Patients with tumour recurrence reported lower role functioning ($p=0.016$), social functioning ($p=0.040$), and more financial problems ($p=0.029$) compared with those without recurrence, as measured using EORTC-QLQ-C30
- Using the EORTC-QLQ – Brain (EORTC-QLQ-BN20) questionnaire, patients with deep tumours reported more bladder control problems ($p=0.016$) than those with cortical tumours.

A cross-sectional study investigating adaptive behaviour, which is the performance on daily activities required for personal and social independence, reported that children with LGG were more impaired on total adaptive behaviour, communication, motor skills, and in the subdomain gross motor skills compared with healthy family controls (effect sizes d , 0.64, 0.86, $p=0.003$) (51). Younger age at diagnosis ($r=-0.357$, $p<0.01$) and treatment with chemotherapy ($r=-0.342$, $p<0.05$) were associated with poorer motor skills, while residual disease was associated with poorer total adaptive behaviour ($r=-0.282$, $p<0.05$).

B.1.3.4.3 Economic burden

There are no data on costs associated with paediatric brain tumours specifically. In the UK, brain cancer is associated with high direct medical costs, with average inpatient, post-diagnosis costs of £13,200. For patients with HGG, annual direct medical costs are estimated at £180,000 (19). The average UK household affected by brain cancer is estimated to be financially worse off by £14,783 a year, compared with £6,840 for all cancers (19).

Despite the high healthcare burden of gliomas, reports of associated direct and indirect costs are scarce and often not comprehensive (52). A Dutch study reported that there are substantial healthcare and societal costs incurred by patients with glioma and their caregivers, with overall costs per year of €20,587.53 (£17,672.63) for patients, and €5,581.49 (£4,790.92)² for caregivers (52). A US study also reported that there were significant out-of-pocket (OOP) costs (medical and non-medical expenses not reimbursed by

² Converted from Euro (EUR) to Great British Pounds (GBP) using the following online currency converter: <https://www.xe.com/currencyconverter/convert/?Amount=5581.49&From=EUR&To=GBP> Where 1 EUR = 0.858864 GBP (25th July 2023)

insurance) for patients with glioma, with a median monthly OOP cost of \$1,342 (£1,043.97), and median lost wages of \$7,500 (£5,834.48)³ (53).

B.1.3.5 Clinical pathway of care

Clinical practice guidelines from the National Institute for Health and Care Excellence (NICE) for the treatment of glioma are not specific to paediatric patients, and are focussed on patients over the age of 16 years (54). Furthermore, guidelines published by the National Comprehensive Cancer Network (NCCN) pertain to the treatment of adult gliomas only (55), while the European Society for Medical Oncology (ESMO) have issued recommendations for treating HGG only, irrespective of the patients' age (56). Likewise, there are no guidelines specific to patients with *BRAF* V600E mutation-positive glioma.

Treatment goals for patients with LGG are generally to prolong overall and progression-free survival (PFS) while minimising treatment-related morbidity. If a patient is eligible, surgical removal is often the treatment of choice, however, most patients will eventually experience disease progression and require post-surgical therapy. Because of the potential risk for long-term neurocognitive effects of radiotherapy in paediatric LGG, the post-surgical therapy often includes chemotherapy.

In 2020, the Children's Cancer and Leukaemia Group (CCLG) published guidelines in the UK for the diagnosis and management of paediatric and adolescent LGG. The guidelines recommend surgery as the first treatment modality, while patients who are contraindicated for surgery, or those who relapse or progress following surgery, are recommended to receive radiotherapy and/or chemotherapy with carboplatin and vincristine (27) as the first line of chemotherapy, and vinblastine as a second-line chemotherapy. The International Society of Paediatric Oncology-Europe-Brain tumour group (SIOP-E-BTG) and the Society of Paediatric Oncology and Haematology (GPOH) guidelines recommend neurosurgical resection, which is curative in approximately 40% of patients with LGG. For progressive disease, the guidelines recommend systemic treatments (57), such as:

- Vincristine/carboplatin
- Vincristine/cisplatin/cyclophosphamide
- Vinblastine
- TPCV (thioguanine, procarbazine, lomustine [CCNU], and vincristine) with carboplatin/vincristine
- Cisplatin/etoposide
- Irinotecan/bevacizumab
- Procarbazine/carboplatin

³ Converted from United States Dollars (USD) to Great British Pounds (GBP) using the following online currency converter:

<https://www.xe.com/currencyconverter/convert/?Amount=7500&From=USD&To=GBP>

Where 1 USD = 0.777910 GBP (25th July 2023)

Company evidence submission template for dabrafenib with trametinib for treating *BRAF* V600E mutation-positive glioma in children and young people aged 1 to 17 [ID5104]

© Novartis (2023). All rights reserved

- Metronomic therapy
- Targeted therapies (BRAF V600E inhibitors and MEK inhibitors).

Current therapies for children with HGG are limited, and there are no specific guidelines for the treatment of paediatric patients with HGG (54-56). The current standard-of-care (SoC) therapy is radiation therapy and where possible, surgical resection (41). There is no standard chemotherapy backbone that is universally acknowledged in the setting of HGG for children and young adults (58); currently, temozolomide (TMZ) is the only chemotherapy with a marketing authorisation in the European Union (EU) for relapsed or refractory HGG (30). However, TMZ is increasingly used upfront as adjuvant treatment in combination with radiotherapy, leaving little options available following relapse. While a variety of therapies have been evaluated in this patient population, response rates have been poor (Section B.1.3.6; Appendix D) and current treatments are associated with burdensome toxicity.

B.1.3.5.1 Positioning of dabrafenib plus trametinib

The proposed positioning of D+T in the clinical pathway of care for managing *BRAF* V600E mutation-positive paediatric gliomas is presented in Figure 3. In line with the NICE final scope and expected marketing authorisation, D+T is indicated for children and young people with *BRAF* V600E mutation-positive LGG that requires systemic treatment, and HGG that has relapsed, progressed or failed to respond to previous systemic treatment.

Figure 3: Proposed positioning of dabrafenib + trametinib for the treatment of *BRAF* V600E mutation-positive paediatric gliomas

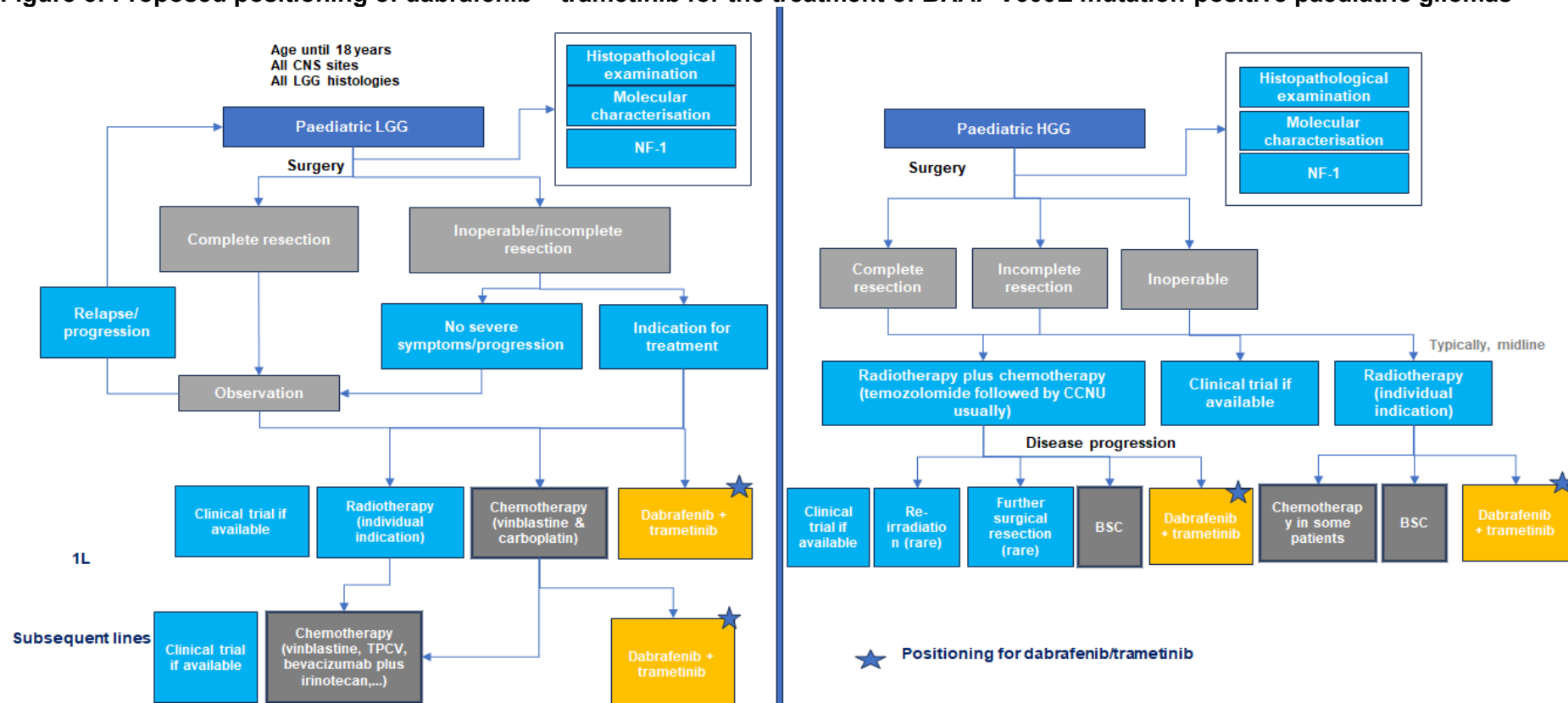

Abbreviations: 1L, first-line; *BRAF*, v-ras murine sarcoma viral oncogene homolog B; BSC: best supportive care; CNS, central nervous system; HGG, high-grade glioma; LGG, low-grade glioma; NF: neurofibromatosis; TPCV: tioguanine, procarbazine, lomustine, vincristine.

Company evidence submission template for dabrafenib with trametinib for treating *BRAF* V600E mutation-positive glioma in children and young people aged 1 to 17 [ID5104]

B.1.3.6 Unmet need

Paediatric gliomas (HGG and LGG) are difficult to treat, with limited options and poor prognosis, and patients who have *BRAF* V600 mutations have no defined treatment pathway.

While LGG is associated with an overall favourable prognosis (15, 16), the presence of a *BRAF* V600E mutation confers poor outcomes with conventional therapies (20).

A combined clinical and genetic institutional study of paediatric patients with LGG who were treated with surgery, radiotherapy, or chemotherapy, reported that patients with *BRAF*-mutant LGG had a 10-year PFS of 27% (95% confidence interval [CI]: 12.1%, 41.9%) compared with 60.2% (95% CI: 53.3%, 67.1%) for those with a *BRAF* wild-type LGG ($p < 0.001$) (20). Currently there are no recommended treatment options for patients who have this mutation, and therefore the availability of a treatment option that targets this mutation could potentially result in significant improvement in patient outcomes. Patients with LGG who progress to secondary HGG are more likely to have a *BRAF* V600 mutation at initial diagnosis, resulting in a poorer prognosis, which further highlights the significant unmet need in this population (17).

Furthermore, paediatric patients treated for LGG may experience long-term neurological morbidities (21). Radiotherapy and/or chemotherapy are associated with a wide range of neurological disorders and endocrine disturbances in LGG. Additionally, radiotherapy has been associated with cognitive deficit and radiological abnormalities in long-term survivors of LGG (59). Therefore, there is an unmet need for anti-cancer therapies that are associated with fewer treatment-related adverse reactions (21).

Although rare, HGG is the leading cause of cancer-related deaths in paediatric patients, accounting for over 40% of CNS tumour-related mortality in children aged 0–14 years (5, 60), with a median survival of 9–18 months (61). As surgical resection remains the best chance of successful treatment for HGG, patients with unresectable tumours are at a clear survival disadvantage; while recent developments in diagnostic techniques have improved the molecular understanding of HGGs, to date, no new therapy has had a notable impact in improving PFS or OS in paediatric patients (41). Furthermore, there is a high likelihood of recurrence following initial treatment in patients with HGG (32).

The European Medicines Agency (EMA) conducted a paediatric research meeting in 2011, focussing on HGG, that highlighted the lack of treatment options and indicated that multi-agent chemotherapy regimens often have burdensome toxicity and provide limited benefit (22). Temozolomide is the only chemotherapy with an EU marketing authorisation for children and young adults in the recurrent disease setting (30). However, trials evaluating TMZ monotherapy or TMZ-based combinations in the recurrent setting had poor response rates, ranging from 0–25% (62–67) (Appendix D). The combination of D+T represents a novel, targeted treatment option for patients with *BRAF* V600E mutation-positive LGG, and refractory or relapsed HGG. Since both *BRAF* and *MEK* are involved in same signalling pathway, and *MEK* is a substrate of activated *BRAF*, inhibiting both proteins simultaneously rather than individually is expected to provide more selective pathway inhibition and improved efficacy of treatment, as well as addressing resistance mechanisms to *BRAF* or *MEK* inhibitor monotherapy (20, 21).

Company evidence submission template for dabrafenib with trametinib for treating *BRAF* V600E mutation-positive glioma in children and young people aged 1 to 17 [ID5104]

Dabrafenib and trametinib are both administered orally, offering a more convenient mode of administration compared with SoC chemotherapies, which are administered intravenously (IV) (23, 24). Patients with cancer have expressed preference for oral treatment compared with IV infusion, due to convenience, ability to receive treatment at home, treatment schedule, and associated side effects (25). The liquid dosage forms also allow for accurate body weight-adjusted dosing in paediatric patients and may represent a better mode of administration, as young children are unable to swallow tablets/capsules. The mode of administration may also improve tolerability amongst older children.

Oral therapy not only improves a patient's quality of life (QoL), but also has an impact on carer QoL, as travel to and length of stay in hospital is burdensome. This undoubtedly has a consequential impact on the remainder of the family unit, as a caregiver accompanies the patient to hospital, spending time away from other family members. Furthermore, attending hospitals for treatment and inpatient stays have a detrimental effect on the family's finances, as the carers take time away from work. This also helps the healthcare resources by being able to treat patients effectively at home (68).

B.1.4 *Equality considerations*

Not applicable.

B.2 Clinical effectiveness

The combination of dabrafenib and trametinib offers improved response rates, durable response and improvements in PFS in paediatric patients with *BRAF* V600E mutation-positive LGG or relapsed or refractory HGG

- The efficacy and safety evidence base to support the use of the combination of dabrafenib and trametinib (D+T) in these indications comes from the TADPOLE study (NCT02684058), a Phase 2, open-label, global trial conducted in paediatric patients with *BRAF* V600E mutation-positive LGG or relapsed or refractory HGG
 - A Phase 1/2 study (NCT02124772) also supports the clinical evidence base of this submission with regard to paediatric patients with relapsed/refractory *BRAF* V600E mutation-positive LGG (69); a summary of which is presented as supplementary data in Appendix O. In line with TADPOLE, patients treated with D+T experienced a clinically meaningful response (overall response rate [ORR]: 25% [95% CI: 12.1, 42.2])
- The LGG cohort (n=110) was a multicentre, randomised, open-label part of the TADPOLE study, conducted in children and adolescents with *BRAF* V600E mutation-positive progressing LGG, whose tumour was unresectable and required treatment
- In this cohort, patients were randomised in a 2:1 ratio to receive either D+T (n=73) or chemotherapy (n=37) consisting of carboplatin with vincristine (C+V). Cross-over between treatments was permitted
- The HGG cohort (n=41) was a multicentre, single-arm, open-label part of the TADPOLE study, conducted in children and adolescent patients with *BRAF* V600E mutation-positive refractory or relapsed HGG tumours after receiving at least one previous therapy
- In both cohorts, the primary endpoint was ORR based on independent review assessment. Secondary endpoints included ORR based on Investigator assessment, duration of response (DOR), and PFS

LGG cohort

- In the LGG cohort, the primary endpoint was reached, with D+T treatment resulting in a clinically meaningful response compared with C+V (54.8% vs 16.2%) using independent assessment, with an odds ratio (OR) of 6.26 (95% CI: 2.3, 16.8)
- Results of ORR per Investigator assessment were consistent with those observed with the independent review, with an OR of 6.14 (95% CI; 2.4, 15.8). Observed responses were also durable for D+T
- As of the final analysis data cut-off (DCO; 28th April 2023), the median PFS per independent assessment was longer in the D+T arm compared with the C+V arm (24.9 months vs 7.2 months), with an estimated 64% risk reduction in progression/death (hazard ratio [HR] 0.36; 95% CI: 0.22, 0.59)

- Similar to that observed for independent review, the Investigator assessment also demonstrated a clinically meaningful benefit in PFS with D+T vs C+V, with an estimated 54% risk reduction in progression/death (HR: 0.46; 95% CI: 0.24, 0.88).
- There was a trend towards improvement for general health and fatigue scores favouring the D+T arm over the C+V arm
- A total of 12 patients crossed over from the C+V arm to the D+T arm

HGG cohort

- D+T met the primary endpoint within the HGG cohort of TADPOLE and was associated with a clinically meaningful and durable response. A clinically meaningful ORR was observed by independent review (56.1%; 95% CI: 39.7, 71.5), and was consistent when determined per Investigator assessment (61.0% (95% CI: 44.5, 75.8))
- As of the final analysis data cut-off (28th April 2023), the median duration of response was 27.4 months (95% CI: 9.2, not estimable [NE]) when determined by independent review and 32.7 months (95% CI: 14.9, NE) per Investigator
- Median PFS (independent review) was 9.0 months (95% CI: 5.3, 20.1)
- In total, 17 patients (41.5%) died, and 24 patients (58.5%) were censored at the time of the final data cut. The estimated OS rates at 12 and 24 months were 77.0% (95% CI: 60.4, 87.3) and 61.0% (95% CI: 43.8, 74.4)

Comparative efficacy evidence for patients with relapsed or refractory HGG

- In the absence of a head-to-head trial comparing D+T with other treatment comparators, an SLR was conducted to identify clinical evidence for treatments in HGG with a *BRAF* V600 mutation. Searches were subsequently broadened to include 'molecularly unselected patients' (e.g. irrespective of mutation), owing to an absence of published data in patients with a *BRAF* V600 mutation
- The broader SLR highlighted the poor outcomes in this population when receiving SoC; with response rates ranging between 0–25%, median PFS ranging between 1–3 months, and median OS ranging between 3–7 months (Appendix D)
- An indirect treatment comparison (ITC) was conducted to determine the relative efficacy in paediatric patients with HGG. Overall, the results from the ITC provided an indication of the relevant benefit of D+T compared with temozolomide, with D+T demonstrating statistically significantly improved OS, PFS, and ORR, compared with temozolomide

The combination of D+T is associated with a tolerable safety profile

- The overall safety profile of D+T within paediatric LGG and HGG patient population is consistent with the safety profile observed in adult patients in approved indications (70)
- In the LGG cohort, Grade ≥ 3 treatment-related adverse events (AEs) and serious adverse events (SAEs) were higher in the C+V arm (Grade ≥ 3 treatment-related

AEs: 87.9%; Grade ≥ 3 treatment-related SAEs: 15.2%) compared with the D+T arm (AEs: 31.5%; SAEs: 9.6%)

- In the HGG cohort, Grade ≥ 3 treatment-related AEs and SAEs were reported in 29.3% and 14.6% of patients, respectively

B.2.1 Identification and selection of relevant studies

A systematic literature review (SLR) was conducted to identify relevant studies reporting clinical efficacy and safety data within the *BRAF* V600 mutation-positive paediatric patient population (children and adolescents) who had LGG or relapsed or refractory HGG. Due to the rare nature of the condition and mutation, a secondary objective of the SLR was to include a broader range of studies, irrespective of mutation (molecularly unselected patients).

- **Primary review objective (focussed population):** Four publications, reporting three studies, were identified from the primary SLR among *BRAF* V600 mutation-positive paediatric patients; two abstracts reported for patients with LGG and HGG treated with D+T (TADPOLE study), representing the pivotal evidence within this submission, one publication was the dose-finding expansion study (CTMT212X2101), while the other was a study of carboplatin + vincristine in LGG that included patients who had Grade I disease only (Appendix D). The SLR did not identify any comparator studies within the *BRAF* V600 mutation-positive paediatric patient population for HGG (where no comparator is available in the TADPOLE study)
- **Secondary review objective (broad population, with a focus on HGG):** In total, 41 publications reported 36 unique studies with data for the broader population. Of these, nine studies reported data for the LGG population. A total of 27 studies for the HGG population were deemed relevant for consideration for the ITC. A summary of these studies is presented in Appendix D. While studies included 'molecularly unselected patients', the review highlighted the expected poor outcomes in this population, with response rates ranging between 0–25%, median PFS ranging between 1–3 months, and median OS ranging between 3–7 months (Appendix D).

B.2.2 List of relevant clinical effectiveness evidence

The primary clinical evidence for dabrafenib and trametinib (D+T) comes from the TADPOLE (NCT02684058) study, which was used in support of the marketing authorisation for D+T in this indication (Table 3). The results of TADPOLE supports the full anticipated marketing authorisation of dabrafenib with trametinib for treating *BRAF* V600E mutation-positive glioma in children and young people.

TADPOLE was a Phase 2, open-label, multicentre, global study in paediatric patients with *BRAF* V600E mutation-positive LGG or relapsed or refractory HGG. An overview of the TADPOLE trial, which provided the clinical evidence base and inputs for the economic model, is provided in Table 3. Data supporting the clinical evidence base were obtained from the final data cut (date: 28th April 2023) clinical study report (CSR) (39). Data from the primary analysis data cut (23rd August 2021) are presented in Appendix N (40).

Company evidence submission template for dabrafenib with trametinib for treating *BRAF* V600E mutation-positive glioma in children and young people aged 1 to 17 [ID5104]

Supplementary data from a Phase 1/2 study (NCT02124772), which reported the efficacy and safety of trametinib monotherapy or in combination with dabrafenib in a subset of patients with paediatric relapsed/refractory *BRAF* V600 mutation-positive LGG, supports the clinical evidence base for this submission (69). However, data from the study are not used to inform the economic evidence base of this submission.

A summary of the study design, methodology, and key results pertaining to the relapsed/refractory LGG cohort are presented in Appendix O.

Table 3: Clinical effectiveness evidence

Study	TADPOLE (NCT02684058)	CTMT212X2101 (NCT02124772)
Study design	Phase 2, open-label, multicentre study	Four-part, Phase 1/2 study
Population	Children and young people aged 1 to 17 years with <i>BRAF</i> V600E mutation-positive glioma: <ul style="list-style-type: none"> • LGG • Relapsed or refractory HGG 	Patients with relapsed/refractory malignancies (exhausting any potentially curative treatments including surgery, radiation, chemotherapy, or combination thereof) <ul style="list-style-type: none"> • Part A enrolled patients with solid tumours (i.e. <i>BRAF</i> V600 mutation was not required) • Part B included expansion cohorts for neuroblastoma, <i>BRAF</i>-fusion LGG, NF-1-associated plexiform neurofibroma, and <i>BRAF</i> V600-mutant tumours • In Parts C and D, patients had <i>BRAF</i> V600-mutant disease; disease-specific expansion cohorts in Part D included LGG and Langerhans cell histiocytosis
Intervention(s)	Dabrafenib twice daily plus trametinib once daily, dosed based on weight, given orally	Trametinib monotherapy or dabrafenib plus trametinib
Comparator(s)	<i>LGG cohort only</i> : Carboplatin 175 mg/m ² and vincristine 1.5 mg/m ² IV given as one induction course (10 weeks of chemotherapy with 2 weeks of rest), followed by 8 cycles of maintenance chemotherapy (6 weeks)	N/A
Indicate if study supports application for marketing authorisation	Yes	Yes
Indicate if study used in the economic model	Yes	No

Rationale if study not used in model	N/A	The study was a single-arm study, and there were limitations associated with design (dose-finding study)
Reported outcomes specified in the decision problem	<u>Primary outcomes:</u> <ul style="list-style-type: none"> • ORR defined as the percentage of patients with confirmed PR or CR according to RANO criteria using independent review assessment <u>Secondary outcome:</u> <ul style="list-style-type: none"> • ORR using investigator assessment • Overall survival • Progression-free survival 	<ul style="list-style-type: none"> • Adverse events • ORR • PFS • OS
All other reported outcomes	<ul style="list-style-type: none"> • Treatment effect for PFS • Time to death following progression • Time to treatment discontinuation 	<ul style="list-style-type: none"> • BOR • DOR • CBR • RP2D • Average Steady State Plasma Concentration

Note: outcomes in **bold** are included in the economic analysis.

Abbreviations: BOR, best overall response; BRAF, v-raf murine sarcoma viral oncogene homolog B; CBR, clinical benefit rate; DOR, duration of response; HGG, high-grade glioma; IV, intravenous; LGG, low-grade glioma; NF-1, neurofibromatosis type 1; ORR, overall response rate; OS, overall survival; PFS, progression-free survival; RP2D, recommended Phase 2 dose; SoC, standard of care.

B.2.3 Summary of methodology of the relevant clinical effectiveness evidence

B.2.3.1 Study design

TADPOLE was a multicentre, open-label, Phase 2 study which comprised two paediatric *BRAF* V600E mutation positive glioma cohorts (LGG and HGG cohorts). The study was conducted in 58 centres across 20 countries, including three UK centres.

B.2.3.1.1 Low-grade glioma cohort

The LGG cohort was a multicentre, randomised, open-label component of the study, which investigated D+T in children and adolescents with *BRAF* V600E mutation-positive, progressing LGG, whose tumour was unresectable and required treatment. In total, 110 patients were randomised in a 2:1 ratio to either the D+T arm, or carboplatin with vincristine (C+V) arm (Figure 4).

Figure 4: Study design for LGG cohort

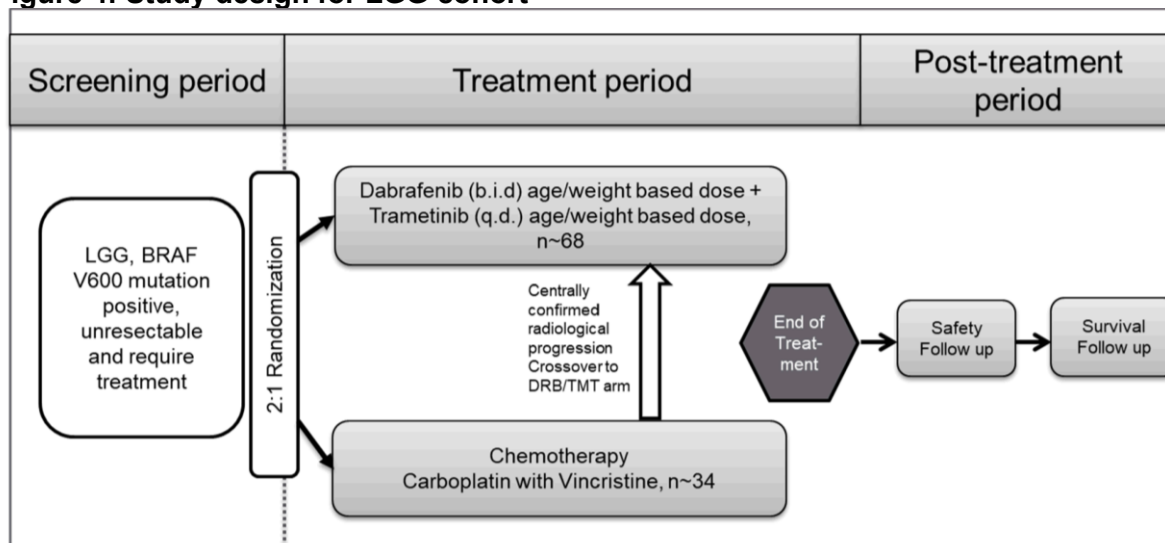

Abbreviations: b.i.d, twice daily; BRAF, v-raf murine sarcoma viral oncogene homolog B; DRB, dabrafenib; LGG, low-grade glioma; q.d, once daily; TMT, trametinib.

Duration of treatment was continued for the prescribed number of cycles as tolerated, or until unacceptable toxicity, start of a new anti-neoplastic therapy, discontinuation at the discretion of the investigator or patient/legal guardian, loss to follow-up, death, study termination by the Sponsor, or disease progression. Patients randomised to the C+V arm were allowed to cross over to receive D+T after centrally confirmed response-assessment for neuro-oncology (RANO)-defined disease progression. Crossover was permitted during the treatment period or the post-treatment period.

All patients were followed for survival for at least 2 years after the last patient first started study treatment (except if consent was withdrawn, death, or the patient was lost to follow-up or discontinued study).

B.2.3.1.2 High-grade glioma cohort

The HGG cohort was a multicentre, single-arm, open-label part of the study, conducted in children and adolescents with *BRAF* V600E mutation-positive, refractory or relapsed HGG, after having received at least one previous SoC therapy (Figure 5). In total, 41 patients were enrolled to receive D+T.

Figure 5: Study design for the HGG cohort

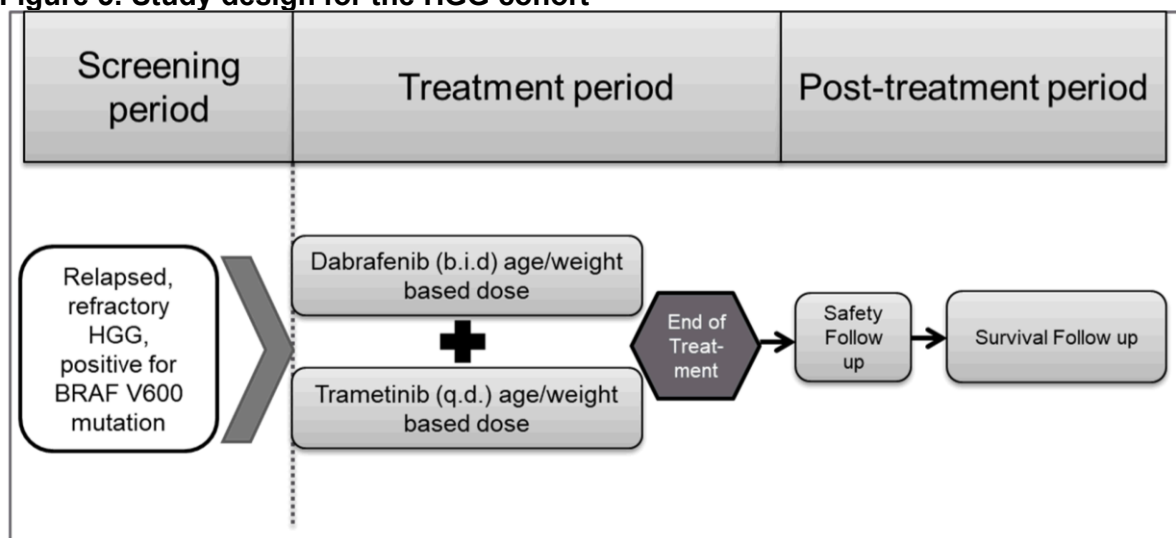

Abbreviations: b.i.d, twice daily; BRAF, v-raf murine sarcoma viral oncogene homolog B; HGG, high-grade glioma; q.d, once daily.

Patients in the HGG cohort continued to receive the assigned study treatment until disease progression by RANO criteria or loss of clinical benefit as determined by the Investigator, unacceptable toxicity, start of a new anti-neoplastic therapy, discontinuation at the discretion of the investigator or patient/legal guardian, loss to follow-up, death, or study termination by the Sponsor.

All patients were to be followed for survival for at least 2 years after the last patient first started study treatment (except if consent was withdrawn, death, or the patient was lost to follow-up, or the study discontinued).

B.2.3.1.3 Study procedures

Each cohort comprised three study periods:

- **Screening period:** Patients were screened for eligibility during the 28 days immediately prior to starting study treatment on Day 1. Eligibility was assessed based on local or central results of histology and *BRAF* V600E mutation, if available at the time of screening
- **Treatment period:** The study treatment phase began on Day 1 with the first administration of study treatment. All patients who received D+T received dabrafenib twice daily and trametinib once daily until they no longer had a clinical benefit as determined by the Investigator, disease progression, death, unacceptable toxicity that precluded further treatment, start of new anti-cancer therapy, or the study was terminated by the Sponsor.

Patients enrolled into the LGG cohort and randomised to the control arm were administered C+V as one course of induction (10 weeks of chemotherapy with two weeks of rest), followed by eight cycles of maintenance chemotherapy. Each maintenance cycle was six weeks. Patients in both cohorts were assessed at screening (within 28 days before initiation of study treatment) and every eight weeks for the first year, and every 16 weeks thereafter for efficacy, using RANO criteria. All radiological scans were collected for independent central review.

Company evidence submission template for dabrafenib with trametinib for treating *BRAF* V600E mutation-positive glioma in children and young people aged 1 to 17 [ID5104]

- **Post-treatment follow-up:** After discontinuation of study treatment, all patients were followed for safety for at least 30 days after the last dose of study treatment except in the case of death, loss to follow-up, or withdrawal of consent. All patients who discontinued study treatment for reasons other than disease progression, death, loss to follow-up, or withdrawal of consent moved into the post-treatment follow-up phase.

B.2.3.1.4 Crossover and continuation of treatment, LGG cohort

For the LGG cohort, patients randomised to the C+V arm were allowed to cross over to receive D+T after centrally confirmed and RANO-defined disease progression. Patients who crossed over were to continue protocol-specified evaluations, including efficacy and safety assessments.

Day 1 of crossover therapy occurred within 90 days from the date of the first centrally confirmed progression. After the final PFS analysis, and assuming significantly favourable ORR and favourable PFS for D+T, patients randomised to the C+V arm with persistent stable disease who were deemed suitable for further systemic therapy were allowed to cross over to receive D+T. Patient-reported outcomes (PRO), taste questionnaires, and pharmacokinetic (PK) samples were not obtained from patients who crossed over.

B.2.3.2 Doses of treatment

In TADPOLE, dosing of D+T was dependent on age and weight, with dabrafenib dosed orally at 2.625 mg/kg twice daily for ages <12 years and at 2.25 mg/kg twice daily for ages 12 years and older; trametinib was dosed orally at 0.032 mg/kg once daily for ages <6 years, and at 0.025 mg/kg once daily for ages 6 years and older. Dabrafenib doses were capped at 150 mg twice daily and trametinib doses at 2 mg once daily.

Formulation selection for dabrafenib was:

- Patients <12 years old and ≥ 16 kg were to be administered either the dabrafenib capsules or dabrafenib dispersible tablets for oral suspension
- Patients ≥ 12 years old and ≥ 19 kg were to be administered either the dabrafenib capsules or dabrafenib dispersible tablets for oral suspension
- Patients <12 years old and <16 kg were to be administered dabrafenib dispersible tablets for oral suspension
- Patients ≥ 12 years old and <19 kg were to be administered dabrafenib dispersible tablets for oral suspension.

Formulation selection for trametinib was:

- Patients <6 years old and <26 kg were to be administered the trametinib oral solution
- Patients <6 years old and ≥ 26 kg were to be administered either the trametinib oral solution or trametinib tablets
- Patients ≥ 6 years old and ≥ 10 kg–<33 kg were to be administered the trametinib oral solution

- Patients ≥ 6 years old and ≥ 33 kg were to be administered either the trametinib oral solution or the trametinib tablets.

Carboplatin and vincristine were dosed based on age and body surface area at doses of 175 mg/m^2 and 1.5 mg/m^2 , respectively, as weekly infusions. Carboplatin and vincristine were administered in one 10-week induction course followed by eight 6-week cycles of maintenance therapy.

B.2.3.2.1 Dose modification

For patients who did not tolerate the protocol-specified dosing schedule, dosing interruptions or modifications were mandated in order to allow patients to continue the study treatment. General guidelines regarding management and dose reduction for adverse events (AE) that were considered by the Investigator to be related to study treatment are provided in Appendix M.

B.2.3.3 Inclusion and exclusion criteria

Key inclusion and exclusion criteria for TADPOLE are presented in Table 4. A full summary of the inclusion and exclusion criteria are presented in Appendix M.

Table 4: Inclusion and exclusion criteria, TADPOLE

Inclusion criteria	Exclusion criteria
<ul style="list-style-type: none"> • Aged between ≥ 12 months and < 18 years. Patients under 6 years old must weigh ≥ 7 kg; patients over 6 years old must weigh ≥ 10 kg 	<ul style="list-style-type: none"> • Malignancy other than <i>BRAF</i> V600 mutant HGG or LGG
<ul style="list-style-type: none"> • For HGG cohort: Relapsed, progressed, or failed to respond to frontline therapy • For LGG cohort: Patients with progressive disease following surgical excision, or non-surgical candidates with necessity to begin first systemic treatment because of a risk of neurological impairment with progression 	<ul style="list-style-type: none"> • Previous treatment with dabrafenib or another RAF inhibitor, trametinib or another MEK inhibitor, or an ERK inhibitor
<ul style="list-style-type: none"> • Locally determined HGG (Grade III–IV) or LGG (Grade I–II) as defined by WHO histological classification system, revised 2016 	<ul style="list-style-type: none"> • Patients with HGG: Anti-cancer therapy (chemotherapy with delayed toxicity, immunotherapy, biologic therapy, vaccine therapy) or investigational drugs ≤ 3 weeks preceding the first dose of study treatment • Patients with LGG: Any systemic anti-cancer therapy (chemotherapy, immunotherapy, biologic therapy, or vaccine therapy) or investigational drugs prior to enrolment
<ul style="list-style-type: none"> • Locally determined and centrally confirmed measurable disease with minimal bi-perpendicular diameter that must be at least twice the imaging slice thickness to be used for efficacy assessments 	<ul style="list-style-type: none"> • Patients with HGG: Radiotherapy to CNS glioma lesions ≤ 3 months prior to first dose of study treatment, unless there is clear evidence of radiologic progression outside of the field of radiation.

Inclusion criteria	Exclusion criteria
	<ul style="list-style-type: none"> Patients with LGG: Radiotherapy to CNS glioma lesions at any point prior to enrolment
<ul style="list-style-type: none"> <i>BRAF</i>m tumour as assessed locally, or at a Novartis designated central reference laboratory if local <i>BRAF</i> V600E testing is unavailable 	<ul style="list-style-type: none"> History of malignancy with confirmed activating <i>RAS</i> mutation or with <i>BRAF</i> fusion such as BRF-KIAA1549 or with known diagnosis of NF1
<ul style="list-style-type: none"> Performance score of $\geq 50\%$ according to the Karnofsky/Lansky performance status scale 	<ul style="list-style-type: none"> Unresolved toxicity greater than NCI CTCAE v4.03 Grade 2 from previous anti-cancer therapy, including major surgery, except those that are not clinically relevant given the know safety/toxicity profile of the study treatment (e.g. alopecia and/or peripheral neuropathy related to platinum or vinca alkaloid-based chemotherapy)

Abbreviations: *BRAF*, v-raf murine sarcoma viral oncogene homolog B; *BRAF*m, v-raf murine sarcoma viral oncogene homolog B mutation-positive; CNS, central nervous system; CTCAE, Common Terminology Criteria for Adverse Events; ERK, extracellular signal-regulated kinase; HGG, high-grade glioma; LGG, low-grade glioma; MEK, mitogen-activated protein kinase kinase; NF1, neurofibromatosis type 1; NCI, National Cancer Institute; *RAS*, rat sarcoma virus; WHO, World Health Organization.

B.2.3.4 Concomitant therapies

An overview of permitted and prohibited concomitant therapies is presented in Appendix M.

B.2.4 Statistical analysis and definition of study groups in the relevant clinical effectiveness evidence

B.2.4.1 LGG cohort

B.2.4.1.1 Primary endpoint

The primary efficacy analysis in the LGG cohort was the comparison of ORR based on independent review assessment between the two treatment arms. The following statistical hypothesis was tested:

$$H_{01}: ORR_t \leq ORR_c \text{ vs } H_{A1}: ORR_t > ORR_c$$

where ORR_t is the ORR in the D+T arm and ORR_c is the ORR in the C+V arm.

The analysis to test these hypotheses and which compared the two treatment groups consisted of a Mantel Haenszel chi-square test at one-sided 2.5% level of significance.

The primary efficacy analysis was performed on the full analysis set (FAS). The ORR was summarised using descriptive statistics (N, %) by treatment arm along with two-sided exact binomial 95% CIs.

B.2.4.1.2 Handling of missing values not related to intercurrent events

Patients with unknown or missing best overall response (BOR) were counted as non-responders in the analysis of ORR. If there was no baseline tumour assessment, all post-

baseline overall lesion responses were considered as 'unknown'. If no valid post-baseline tumour assessments were available, the BOR was considered as 'unknown'. For the computation of ORR, these patients were included in the FAS and were counted as 'non-responders'. If a patient was determined to have non-measurable disease only, then the category of response could be expanded to include non-complete response (CR)/non-progressive disease (PD).

B.2.4.1.3 Supportive and sensitivity analysis

Sensitivity analyses for the primary endpoint were performed using the evaluable analysis set. The analyses of ORR, DOR, and PFS were repeated based on radiological response assessed by independent review by only incorporating the radiographic data in the FAS. ORR was summarised using descriptive statistics (N, %) along with two-sided exact binomial 95% and 80% CIs.

In addition, ORR, DOR, and PFS were evaluated using an intention-to-treat (ITT) approach, i.e. including all response assessments irrespective of new anti-neoplastic therapy using the FAS.

B.2.4.2 HGG cohort

B.2.4.2.1 Primary endpoint

The primary analysis in the HGG cohort was performed on the FAS. Point estimates and the exact binomial CIs of ORR were provided. The lower bound of the CIs were used to provide evidence that the true ORR was greater than a certain specific response rate. The 95% CI, via the lower limit, was used to establish the levels of response which were exceeded by taking the combination therapy according to a robust standard of evidence (i.e. one-sided $\alpha=0.025$). For example, out of 40 patients who were enrolled and completed at least 32 weeks of treatment or discontinued treatment earlier, if 14 responses (35%) were observed, then the corresponding 95% CI excluded 20%, which is greater than the typical standard of care response rate reported previously (62, 64, 65, 67, 71).

B.2.4.2.2 Handling of missing values

Patients with unknown or missing BOR were counted as 'failures'. If there was no baseline tumour assessment, all post-baseline overall lesion responses were considered as 'unknown'. If no valid post-baseline tumour assessments were available, the BOR was assigned 'unknown' unless progression was reported. For the computation of ORR, these patients were included in the FAS and were counted as 'failures'.

B.2.4.2.3 Supportive and sensitivity analysis

Sensitivity analyses for the primary endpoint were performed using the evaluable set. The analyses of ORR, DOR, and PFS were repeated based on radiographic response assessed by independent review by only incorporating the radiographic data which includes the lesion measurements from target lesions, non-target lesions, and new lesion per RANO.

B.2.4.3 Secondary endpoints

The secondary endpoints for LGG and HGG cohorts are presented in Table 5.

Table 5: Secondary endpoints for LGG and HGG cohorts

Secondary endpoints		
LGG cohort	HGG cohort	Statistical analysis
ORR by investigator assessment by RANO criteria		Analysed based on the FAS and the evaluable set separately. ORR was summarised using descriptive statistics (N, %) along with 2-sided exact 95% and 80% CIs
DOR, calculated as the time from the first documented confirmed response (CR or PR) to the first documented progression or death due to any cause, as assessed separately by investigator and independent central reviewer by RANO criteria		<p>DOR was analysed as per Investigator and central independent reviewer assessments separately. The analyses of DOR was based on the FAS and was repeated based on the evaluable set. The start date was the date of first documented response of CR or PR (i.e. the start date of response, not the date when response was confirmed), and the end date was defined as the date of the first documented progression per RANO or death due to any cause. If a patient had not progressed or died or had received any further anticancer therapy at the analysis cut-off date, DOR was censored at the date of the last adequate tumour evaluation date before the cut-off date or before the start of the new anti-cancer therapy date, whichever was earlier.</p> <p>If a sufficient number of responses was observed, the KM estimate of the distribution function was constructed. The number of patients at risk at certain time points was shown on the plot. The estimated median (in weeks) along with 95% CIs, as well as 25th and 75th percentiles were reported. In addition, KM-estimated probabilities with corresponding 95% CIs at several time points (including at least 4, 6, and 12 months) were summarised. Censoring reasons were also summarised</p>
PFS, defined as time from date of randomisation to progression or death due to any cause, as assessed separately by central independent reviewer and investigator by RANO criteria		<p>PFS analysis was based on FAS and evaluable set separately</p> <p>PFS was calculated using RANO criteria based on Investigator and central independent review of tumour assessments separately. The analysis included all data observed up-to the cut-off date. If a patient did not progress or die or received any further anti-cancer therapy at the analysis cut-off date, PFS was censored at the date of the last adequate tumour evaluation date before the cut-off date, or before the start of the new anti-cancer therapy date, whichever is earlier. Discontinuation due to disease progression (collected on the 'End of treatment' and 'End of post treatment follow up' disposition pages) without supporting evidence</p>

Secondary endpoints		
LGG cohort	HGG cohort	Statistical analysis
		satisfying progression criteria per RANO was not considered disease progression for PFS derivation. PFS was described in tabular and graphical format using KM methods as described for DOR, including estimated median (in months) with 95% CI, 25 th and 75 th percentiles, and KM estimated probabilities with corresponding 95% CIs at 6, 12, 18 and 24 months. Censoring reasons were also summarised
	TTR, calculated as the time from the date of randomisation to first documented confirmed response CR or PR (which must be confirmed subsequently) as assessed separately by investigator and independent central reviewer by RANO criteria	<ul style="list-style-type: none"> • TTR was analysed using Investigator and independent reviewer assessments separately • TTR (CR or PR) was the time from start date of study treatment to first documented response of CR or PR (which must be confirmed subsequently) according to RANO criteria. All patients in the FAS were included in the time to response calculation. Patients who did not achieve a confirmed PR or CR were censored at: <ul style="list-style-type: none"> ○ the maximum follow-up time (i.e. PPFV-LPLV used for the analysis) for patients who had a PFS event (i.e. either progressed or died due to any cause); ○ the last adequate tumour assessment date for all other patients <p>The distribution of time to response was estimated using the KM method and the median time to response was presented along with 95% CI only if a sufficient number of responses is observed. In addition, a responders-only analysis was also performed in this case using descriptive summary statistics</p>
	CBR is the proportion of patients with a BOR of CR or PR, or an overall lesion response of SD which lasts for a minimum time duration of at least 24 weeks, as assessed separately by investigator and independent central reviewer by RANO criteria	<p>CBR was analysed using Investigator and independent reviewer assessments and calculated using the FAS and evaluable set separately. CBR was defined as the proportion of patients with a best overall response of CR or PR, or an overall lesion response of SD which lasts for a minimum time duration of 24 weeks. A patient was considered to have SD for 24 weeks or longer if a SD response was recorded at 23 weeks or later (i.e. ≥ 161 days) from treatment start date, allowing for the ± 1 week visit window for tumour assessments</p> <p>CBR was summarised using descriptive statistics (n, %) along with two-sided exact binomial 95% CIs</p>
	OS, defined as the time from date of randomisation to death due to any cause	OS was defined as the time from start date of study treatment to date of death due to any cause. A cut-off date was established for each analysis of OS.

Secondary endpoints		
LGG cohort	HGG cohort	Statistical analysis
		All deaths occurring on or before the cut-off date in the FAS were used in the OS analysis. If a patient was not known to have died at the time of analysis cut-off, OS was censored at the date of last contact

Abbreviations: AE, adverse event; BOR, best overall response; CBR, clinical benefit rate; CI, confidence interval; CR, complete response; DOR, duration of response; ECG, electrocardiogram; ECHO, echocardiogram; FAS, full analysis set; FPFV, first patient first visit; HGG, high-grade glioma; KM, Kaplan-Meier; LGG, low-grade glioma; LPLV, last patient last visit; OS, overall survival; PFS, progression-free survival; PR, partial response; PROMIS, Patient Reported Outcomes Measurement Information Service; RANO, Response Assessment in Neuro-Oncology; SAE, serious adverse event; SD, stable disease; TTR, time to response.

B.2.4.4 Analysis sets

Table 6: Analysis sets, TADPOLE

Analysis set	LGG cohort	HGG cohort
FAS	Comprised all patients to whom study treatment was assigned by randomisation regardless of whether or not treatment was administered. According to the intent to treat principle, patients were analysed according to the treatment they were assigned to during the randomisation procedure	Included all patients to whom study treatment was assigned and who received ≥ 1 dose of study treatment
Safety set	All patients who received at least one dose of study treatment	
	Patients were analysed according to the study treatment received, where treatment received was defined as the randomised treatment if the patient received ≥ 1 dose of that treatment, or the first treatment received if the randomised treatment was never received	–
PAS	All patients who received ≥ 1 dose (full or partial) dose of dabrafenib or trametinib and provided at least one evaluable PK blood sample	
Evaluable set	All evaluable patients in the FAS who had centrally confirmed measurable disease, a positive <i>BRAF</i> V600E mutation, an adequate tumour assessment at baseline, and a follow-up tumour assessment at least 8 weeks after starting treatment (unless disease progression was observed before that time) or discontinued for any reason. The evaluable set was used for sensitivity analyses	
	–	Required that the patient's tumour was centrally confirmed by histopathology to be HGG

Abbreviations: BRAF, v-raf murine sarcoma viral oncogene homolog B; FAS, full analysis set; HGG, high-grade glioma; LGG, low-grade glioma; PAS, pharmacokinetic analysis set; PK, pharmacokinetic.

B.2.5 Critical appraisal of the relevant clinical effectiveness evidence

Appendix D contains the quality assessment of the trials identified in the SLR.

B.2.6 Clinical effectiveness results of the relevant studies

B.2.6.1 Patient disposition

In total, 151 patients were enrolled in the study. The study was conducted in 58 centres across 20 countries, with three centres based in the UK.

B.2.6.1.1 LGG cohort

In total, 121 patients were screened for entry into the LGG cohort, of whom 110 patients were recruited upon completion of the screening phase and were randomised in a 2:1 ratio to the D+T arm (n=73) or the C+V arm (n=37). Patient disposition within analysis sets is presented in Table 7.

Table 7: Patient disposition within analysis sets, LGG cohort

Analysis set	D+T N=73 n (%)	C+V N=37 n (%)	All patients N=110
FAS-LGG	73 (100.0)	37 (100.0)	110 (100.0)
Safety set-LGG	73 (100.0)	33 (89.2)	106 (96.4)
PAS-LGG	69 (94.5)	0	69 (62.7)
Evaluable analysis set-LGG	49 (67.1)	19 (51.4)	68 (61.8)
Crossover set-LGG	0	12 (32.4)	12 (10.9)

Abbreviations: C, carboplatin; D, dabrafenib; FAS, full analysis set; LGG, low-grade glioma; PAS, pharmacokinetic set; T, trametinib; V, vincristine.

As of the final analysis DCO, 70 patients (63.6%) had completed treatment (76.7% in the D+T arm vs 37.8% in the C+V arm). A total of 36 patients (32.7%) discontinued treatment. Most patients discontinued due to disease progression (12.7%); the proportion of patients discontinuing due to progressive disease was higher in the C+V arm than in the D+T arm (27.0% vs 5.5%). Eleven patients (10.0%) discontinued due to AE (three patients [4.1%] in the D+T arm vs eight patients [21.6%] in the C+V arm).

B.2.6.1.2 HGG cohort

In total, 46 patients were screened for entry into the HGG cohort, of whom 41 patients entered the study upon completion of the screening phase.

As of the final analysis DCO date, 17 patients (41.5%) had completed treatment. Twenty-four patients (58.5%) discontinued treatment; most patients discontinued due to progressive disease (46.3%), while two patients died, two patients discontinued due to the physician's decision, and one patient discontinued due to an AE.

Of the five patients who entered the post-treatment follow-up, three patients died, and two patients completed post-treatment follow-up. Nine patients entered the survival follow-up, seven of whom died.

B.2.6.1.3 Demographics and baseline characteristics

B.2.6.1.3.1 LGG cohort

The demographic and baseline characteristics of patients within the LGG cohort are outlined in Table 8. Demographics were generally well-balanced between the two treatment arms. The median age of patients with LGG was 9.5 years (range 1–17). Most of the patients were White (72.7%). There were more female than male patients (60.0% vs 40.0%). None of the patients had a Lansky and Karnofsky performance (KPS/LPS) score below 70 at study entry.

The predominant tumour histologies at baseline were pilocytic astrocytoma (30.9%), ganglioglioma (27.3%), and LGG not otherwise specified (NOS; 18.2%). The majority of patients (80.0%) presented with Grade I gliomas, with 18.2% of patients presenting with Grade II disease. The median time since initial diagnosis to study entry was 3.5 months (range: 0.7–199.9).

Table 8: Demographics and baseline disease characteristics, FAS-LGG

	D+T N=73	C+V N=37	All patients N=110
Demographics			
Age (years)			
Mean (SD)	9.3 (4.97)	8.8 (5.01)	9.1 (4.96)
Median	10.0	8.0	9.5
Q1–Q3	5.0–13.0	4.0–13.0	5.0–13.0
Min, Max	1.0–17.0	1.0–17.0	1.0–17.0
Age category, n (%)			
12 months–<6 years	20 (27.4)	14 (37.8)	34 (30.9)
6–<12 years	25 (34.2)	11 (29.7)	36 (32.7)
12–<18 years	28 (38.4)	12 (32.4)	40 (36.4)
Sex, n (%)			
Female	44 (60.3)	22 (59.5)	66 (60.0)
Male	29 (39.7)	15 (40.5)	44 (40.0)
Race, n (%)			
White	55 (75.3)	25 (67.6)	80 (72.7)
Asian	5 (6.8)	3 (8.1)	8 (7.3)
Black or African American	2 (2.7)	3 (8.1)	5 (4.5)
Unknown	6 (8.2)	4 (10.8)	10 (9.1)
Other	3 (4.1)	1 (2.7)	4 (3.6)
Not reported	2 (2.7)	1 (2.7)	3 (2.7)
Ethnicity, n (%)			

	D+T N=73	C+V N=37	All patients N=110
Not Hispanic or Latino	48 (65.8)	17 (45.9)	65 (59.1)
Hispanic or Latino	8 (11.0)	4 (10.8)	12 (10.9)
Unknown	5 (6.8)	5 (13.5)	10 (9.1)
Not reported	12 (16.4)	11 (29.7)	23 (20.9)
Weight (kg)			
No. of patients	73	33	106
Mean (SD)	43.02 (26.364)	43.81 (26.527)	43.27 (26.291)
Median	36.50	38.20	36.75
Q1–Q3	22.30–61.80	22.40–60.60	22.30–61.80
Min, Max	7.8–115.0	9.0–110.3	7.8–115.0
BMI (kg/m²)			
No. of patients	73	33	106
Mean (SD)	21.73 (10.594)	21.43 (6.128)	21.64 (9.403)
Median	19.39	20.13	19.50
Q1–Q3	16.81–24.02	17.37–23.91	16.92–24.02
Min, Max	13.1–97.7	15.5–40.9	13.1–97.7
BSA (m²)			
No. of patients	73	33	106
Mean (SD)	1.26 (0.516)	1.27 (0.506)	1.26 (0.510)
Median	1.22	1.26	1.22
Q1–Q3	0.85–1.66	0.86–1.69	0.86–1.69
Min, Max	0.4–2.4	0.5–2.3	0.4–2.4
Lansky and Karnofsky performance status, n (%)			
No. of patients	73	33	–
100	44 (60.3)	17 (51.5)	–
90	20 (27.4)	12 (36.4)	–
80	7 (9.6)	2 (6.1)	–
70	2 (2.7)	2 (6.1)	–
<70	0	0	–
Baseline disease characteristics			
Pathology at initial diagnosis, n (%)			
Astrocytoma	1 (1.4)	1 (2.7)	2 (1.8)
Desmoplastic astrocytoma, NOS	0	1 (2.7)	1 (0.9)
Desmoplastic infantile astrocytoma	2 (2.7)	1 (2.7)	3 (2.7)
Diffuse astrocytoma	1 (1.4)	1 (2.7)	2 (1.8)
Diffuse glioma, NOS	2 (2.7)	0	2 (1.8)
Ganglioglioma	21 (28.8)	9 (24.3)	30 (27.3)
Glioneuronal, NOS	2 (2.7)	1 (2.7)	3 (2.7)
Infantile desmoplastic ganglioglioma	1 (1.4)	0	1 (0.9)

	D+T N=73	C+V N=37	All patients N=110
LGG, NOS	14 (19.2)	6 (16.2)	20 (18.2)
Pilocytic astrocytoma	22 (30.1)	12 (32.4)	34 (30.9)
Pleomorphic xanthoastrocytoma	6 (8.2)	5 (13.5)	11 (10.0)
Missing	1 (1.4)	0	1 (0.9)
Histological grade at initial diagnosis, n (%)			
Grade I	60 (82.2)	28 (75.7)	88 (80.0)
Grade II	12 (16.4)	8 (21.6)	20 (18.2)
Grade III	0	0	0
Grade IV	0	0	0
Missing	1 (1.4)	1 (2.7)	2 (1.8)
Time since initial diagnosis of primary site to study entry (months)			
No. of patients	73	33	106
Mean (SD)	15.4 (31.69)	6.5 (11.57)	12.7 (27.32)
Median	4.6	2.4	3.4
Q1–Q3	1.8–14.2	1.9–3.8	1.8–10.4
Min, Max	0.9–199.9	0.7–62.2	0.7–199.9
<i>BRAF</i> mutation status [†]			
V600E	72 (98.6)	35 (94.6)	107 (97.3)
Non-mutant	0	1 (2.7)	1 (0.9)
Other	1 (1.4)	0	1 (1.4)
Missing	0	1 (2.7)	1 (0.9)
Indication to treatment			
Blindness, one eye, low vision other eye	2 (2.7)	2 (5.4)	4 (3.6)
Clinical progression	21 (28.8)	7 (18.9)	28 (25.5)
Deterioration of visual acuity	19 (26.0)	11 (29.7)	30 (27.3)
Diencephalic syndrome of infancy	1 (1.4)	0	1 (0.9)
Neurologic symptoms	31 (42.5)	19 (51.4)	50 (45.5)
Nystagmus	9 (12.3)	5 (13.5)	14 (12.7)
Pressure effect of tumour mass	17 (23.3)	10 (27.0)	27 (24.5)
Radiological progression	44 (60.3)	15 (40.5)	59 (53.6)
Abnormal vision	22 (30.1)	19 (51.4)	41 (37.3)
Missing	1 (1.4)	0	1 (0.9)
Any metastatic sites			
Yes	7 (9.6)	2 (5.4)	9 (8.2)
No	66 (90.4)	35 (94.6)	101 (91.8)

Note: Presence/absence of target and non-target lesions based on the data collected on RANO target/non-target lesion assessment eCRF pages.

[†]Local *BRAF* is presented when available, otherwise, central *BRAF* is presented. Four patients were enrolled with central *BRAF* status; three patients had local *BRAF* status of 'other' that were V600E centrally. In addition,

Company evidence submission template for dabrafenib with trametinib for treating *BRAF* V600E mutation-positive glioma in children and young people aged 1 to 17 [ID5104]

one patient withdrew consent prior to treatment, with no local result entered, prior to central result analysis. Abbreviations: BMI, body mass index; BRAF, v-raf murine sarcoma viral oncogene homolog B; BSA, body surface area; C, carboplatin; D, dabrafenib; eCRF, electronic case report form; FAS, full analysis set; LGG, low-grade glioma; NOS, not otherwise specified; Q, quartile; RANO, Response-Assessment for Neuro-Oncology; SD, standard deviation; T, trametinib; V, vincristine.

B.2.6.1.3.2 HGG cohort

The demographic and baseline characteristics of patients in the HGG cohort are outlined in Table 9. Median age of patients was 13.0 years (range: 2–17). There were more female than male patients (56.1% vs 43.9%). The majority of patients were white (61.0%). Five patients (12.2%) had a KPS/LPS score <70.

The predominant tumour histology at the time of initial diagnosis was glioblastoma multiforme (31.7%). Twenty patients (48.8%) presented with Grade IV gliomas and 13 patients (31.7%) with Grade III disease. Seven patients had initial diagnoses of Grade I or Grade II glioma and subsequently transformed into HGG prior to study entry. The median time since initial diagnosis was 17.4 months (range: 2.7–174.3). The median time since last recurrence/progression to study entry was 1.7 months (range: 0.3–18.2).

Table 9: Demographics and baseline disease characteristics, FAS-HGG

	All patients N=41
Demographics	
Age (years)	
Mean (SD)	12.12 (4.451)
Median	13.00
Q1–Q3	10.00–16.00
Min, Max	2.0, 17.0
Age category, n (%)	
12 months–<6 years	5 (12.2)
6–<12 years	10 (24.4)
12–<18 years	26 (63.4)
Sex, n (%)	
Female	23 (56.1)
Male	18 (43.9)
Race, n (%)	
White	25 (61.0)
Asian	11 (26.8)
Black or African American	1 (2.4)
Unknown	3 (7.3)
Not reported	1 (2.4)
Ethnicity, n (%)	
Not Hispanic or Latino	26 (63.4)
Hispanic or Latino	5 (12.2)
Unknown	3 (7.3)

	All patients N=41
Not reported	7 (17.1)
Weight (kg)	
Mean (SD)	49.82 (27.381)
Median	44.90
Q1–Q3	33.20–57.40
Min, Max	11.3, 155.6
BMI (kg/m ²)	
No. of patients	40
Mean (SD)	20.58 (7.390)
Median	18.34
Q1–Q3	16.58–21.55
Min, Max	10.4, 48.8
Lansky and Karnofsky performance status, n (%)	
100	15 (36.6)
90	13 (31.7)
80	7 (17.1)
70	1 (2.4)
<70	5 (12.2)
Baseline disease characteristics	
Pathology at initial diagnosis, n (%)	
Anaplastic astrocytoma	3 (7.3)
Anaplastic ganglioglioma	2 (4.9)
Anaplastic pilocytic astrocytoma	1 (2.4)
Anaplastic pleomorphic xanthoastrocytoma	6 (14.6)
Diffuse midline glioma (H3K27M Mutated)	2 (4.9)
Diffuse midline glioma, NOS	1 (2.4)
Epithelioid glioblastoma multiforme	1 (2.4)
Ganglioglioma	1 (2.4)
Glioblastoma multiforme	13 (31.7)
HGG, NOS	4 (9.8)
LGG, NOS	1 (2.4)
Oligodendroglioma	1 (2.4)
Pleomorphic Xanthoastrocytoma	4 (9.8)
Unknown	1 (2.4)
Histological grade at initial diagnosis, n (%)	
Grade I	3 (7.3)
Grade II	4 (9.8)
Grade III	13 (31.7)
Grade IV	20 (48.8)

	All patients N=41
Missing	1 (2.4)
Time since initial diagnosis of primary site to study entry (months)	
Mean (SD)	30.5 (38.89)
Median	17.4
Q1–Q3	8.3–30.4
Min, Max	2.7, 174.3
<i>BRAF</i> mutation status [†]	
V600E	41 (100)
Time from initial diagnosis to first recurrence/progression (months)	
No. of patients	21
Mean (SD)	16.0 (19.56)
Median	10.9
Min, Max	3.5, 73.5
Time since last recurrence/progression to study entry (months)	
No. of patients	7
Mean (SD)	4.6 (6.37)
Median	1.7
Min, Max	0.3, 18.2

Note: Presence/absence of target and non-target lesions based on the data collected on RANO target/non-target lesion assessment eCRF pages.

[†]Local *BRAF* is presented when available otherwise central *BRAF* is presented. Five patients were enrolled with central *BRAF* status.

Abbreviations: BMI, body mass index; *BRAF*, v-raf murine sarcoma viral oncogene homolog B; BSA, body surface area; C, carboplatin; D, dabrafenib; eCRF, electronic case report form; FAS, full analysis set; HGG, high-grade glioma; NOS, not otherwise specified; Q, quartile; RANO, Response-Assessment for Neuro-Oncology; SD, standard deviation; T, trametinib; V, vincristine.

B.2.6.2 Clinical effectiveness

Results from the final analysis data cut (28th April 2023) are presented in Sections B.2.6.1–B.2.7. Results from the primary analysis data cut (23rd August 2021) are presented in Appendix N.

B.2.6.2.1 LGG cohort

B.2.6.2.1.1 Primary endpoint – Overall response rate by independent review, FAS-LGG (Final analysis data cut)

In the LGG cohort, the study met the pre-defined success criteria of ORR by independent review. There was a clinically meaningful difference in ORR by independent review with D+T (ORR: 54.8%; 95% CI: 42.7, 66.5) compared with the C+V arm (ORR: 16.2%; 95% CI: 6.2, 32.0), with an odds ratio (OR) of 6.26 (95% CI: 2.3, 16.8) (Table 10).

A higher clinical benefit rate (CBR) was demonstrated in the D+T arm compared with the C+V arm by independent review (CBR: 86.3% vs 43.2%). Complete responses (CR) were reported in two patients (2.7%) in the D+T arm and one patient (2.7%) in the C+V arm. Progressive disease as best response was reported in 11.0% and 35.1% of patients, respectively (Table 10).

Table 10: Independent reviewer-assessed ORR using RANO criteria, FAS-LGG

	D+T N=73 n (%)	C+V N=37 n (%)	Odds ratio between treatment groups	
			OR [†]	95% CI [†]
Best overall response				
CR	2 (2.7)	1 (2.7)	–	–
PR	38 (52.1)	5 (13.5)	–	–
SD	24 (32.9)	12 (32.4)	–	–
PD	8 (11.0)	13 (35.1)	–	–
Unknown	1 (1.4)	6 (16.2)	–	–
ORR:CR+PR 95% CI	40 (54.8) 42.7, 66.5	6 (16.2) 6.2, 32.0	6.26	2.3, 16.8
CBR:CR+PR+SD 95% CI	63 (86.3) 76.2, 93.2	16 (43.2) 27.1, 60.5	8.27	3.3, 21.0

Data cut: Final analysis data cut, 28th April 2023.

[†]Odds ratio (D+T vs C+V) and 95% CI are from a logistic regression with treatment as the only covariate. Odds ratio >1 favours D+T.

Abbreviations: C, carboplatin; CBR, clinical benefit rate; CI, confidence interval; CR, complete response; D, dabrafenib; FAS, full analysis set; LGG, low-grade glioma; OR, odds ratio; ORR, overall response rate; PD, progressive disease; PR, partial response; RANO, response-assessment for neuro-oncology; SD, stable disease; T, trametinib; V, vincristine.

B.2.6.2.1.2 Secondary endpoints

B.2.6.2.1.2.1 ORR by Investigator assessment, FAS-LGG (Final analysis data cut)

Results of ORR by Investigator assessment were consistent with those observed by independent review. The ORR by Investigator assessment was higher in the D+T arm (ORR: 58.9%; 95% CI: 46.8, 70.3) compared with the C+V arm (ORR: 18.9%; 95% CI: 8.0, 35.2) with an OR of 6.14 (95% CI: 2.4, 15.8). The concordance rate of BOR between independent review and Investigator assessment was 65.5% (Appendix N).

A higher CBR was demonstrated in the D+T arm (CBR 91.8%; 95% CI: 83.0, 96.9) compared with the C+V arm (CBR 56.8%; 95% CI: 39.5, 72.9). Complete response was reported in three patients (4.1%) in the D+T arm, and none of the patients in the C+V arm. Progressive disease as best response was reported in 5.5% and 24.3% of patients, respectively (Table 11).

Table 11: Investigator assessed-ORR using RANO criteria, FAS-LGG

	D+T N=73 n (%)	C+V N=37 n (%)	Odds ratio between treatment groups	
			OR [†]	95% CI [†]
Best overall response				
CR	3 (4.1)	0	–	–
PR	40 (54.8)	7 (18.9)	–	–
SD	25 (34.2)	15 (40.5)	–	–
PD	4 (5.5)	9 (24.3)	–	–
Unknown	1 (1.4)	6 (16.2)	–	–
ORR:CR+PR 95% CI	43 (58.9) 46.8, 70.3	7 (18.9) 8.0, 35.2	6.14	2.4, 15.8
CBR:CR+PR+SD 95% CI	67 (91.8) 83.0, 96.9	21 (56.8) 39.5, 72.9	8.51	3.0, 24.5

Data cut: Final analysis data cut, 28th April 2023.

†Odds ratio (D+T vs C+V) and 95% confidence interval are from a logistic regression with treatment as the only covariate. Odds ratio > 1 favours D+T.

Abbreviations: C, carboplatin; CBR, clinical benefit rate; CI, confidence interval; CR, complete response; D, dabrafenib; FAS, full analysis set; LGG, low-grade glioma; OR, odds ratio; ORR, overall response rate; PD, progressive disease; PR, partial response; RANO, Response-Assessment for Neuro-Oncology; SD, stable disease; T, trametinib; V, vincristine.

B.2.6.2.1.2 Duration of response by independent review and Investigator assessment, FAS-LGG (Final analysis data cut)

As of the final data cut, observed responses in the D+T arm were durable. Among the 40 patients with confirmed CR or PR as per independent review (Table 12), 20 patients (50%) had subsequently experienced disease progression or death, with an estimated median DOR of 30.0 months (95% CI: 16.6, NE).

Table 12: TADPOLE summary of DOR based on independent review and Investigator assessment by RANO criteria, FAS-LGG

Estimates	Independent review		Investigator assessment	
	D+T N=73	C+V N=37	D+T N=73	C+V N=37
No. of responders [†] n (%)	40 (54.8)	6 (16.2)	43 (58.9)	7 (18.9)
No. of events	20 (50.0)	4 (66.7)	12 (27.9)	3 (42.9)
No. censored	20 (50.0)	2 (33.3)	31 (72.1)	4 (57.1)
Percentiles (months) (95% CI)[‡]				
25 th	12.0 (5.6, 20.3)	7.3 (6.6, 27.6)	33.1 (21.9, 44.4)	15.6 (5.3, NE)
50 th	30.0 (16.6, NE)	19.4 (6.6, NE)	44.4 (33.1, NE)	22.5 (5.3, NE)
75 th	47.8 (34.5, NE)	27.6 (7.3, NE)	NE (44.4, NE)	NE (15.6, NE)

Estimates	Independent review		Investigator assessment	
	D+T N=73	C+V N=37	D+T N=73	C+V N=37
KM event-free estimates (95% CI)				
4 months	97.5 (83.5, 99.6)	100.0 (100.0, 100.0)	100.0 (100.0, 100.0)	100.0 (100.0, 100.0)
6 months	85.0 (69.6, 93.0)	100.0 (100.0, 100.0)	97.7 (84.6, 99.7)	85.7 (33.4, 97.9)
12 months	74.8 (58.2, 85.6)	66.7 (19.5, 90.4)	95.3 (82.5, 98.8)	85.7 (33.4, 97.9)
18 months	63.4 (45.9, 76.5)	66.7 (19.5, 90.4)	92.8 (79.2, 97.6)	68.6 (21.3, 91.2)
24 months	55.9 (37.7, 70.7)	44.4 (6.6, 78.5)	87.5 (72.4, 94.6)	45.7 (6.9, 79.5)
30 months	44.8 (25.2, 62.7)	NE (NE, NE)	75.9 (56.6, 87.5)	45.7 (6.9, 79.5)

Data cut: Final analysis data cut, 28th April 2023.

Event: progression disease or death due to any cause.

†Responders means BOR is CR or PR.

Abbreviations: BOR, best overall response; C, carboplatin; CI, confidence interval; CR, complete response; D, dabrafenib; DOR, duration of response; FAS, full analysis set; KM, Kaplan-Meier; LGG, low-grade glioma; NE, not estimable; PR, partial response; RANO, Response-Assessment for Neuro-Oncology; T, trametinib; V, vincristine.

The median DOR by Investigator assessment was 44.4 months (95% CI: 33.1, NE) in the D+T arm (Table 12). The Kaplan-Meier (KM) plots of DOR by independent review and by Investigator assessment are presented in Figure 6 and Figure 7, respectively. A Swimmer plot for time to onset and DOR per RANO criteria per independent review is presented in Appendix N.

Figure 6: Kaplan-Meier plot of DOR by independent review and using RANO criteria, FAS-LGG

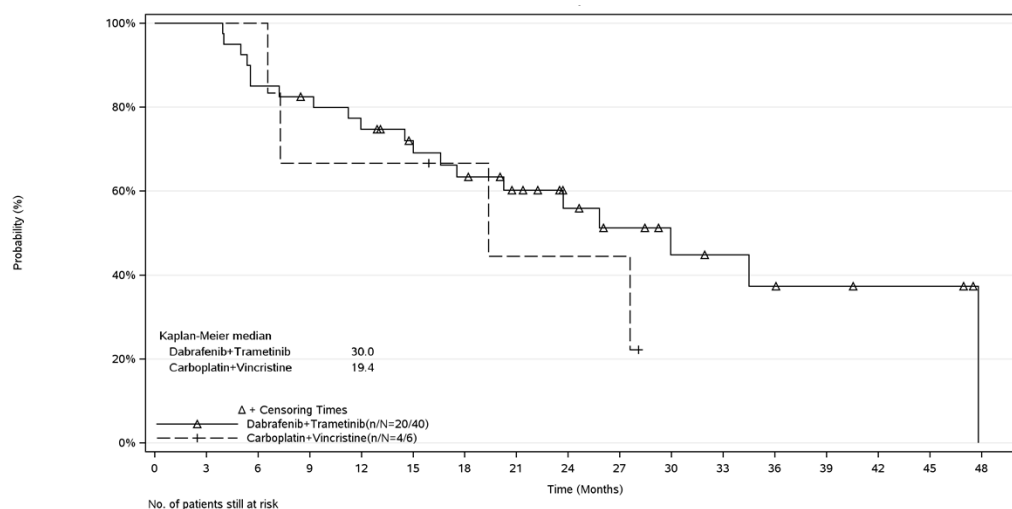

Time (Months)	0	3	6	9	12	15	18	21	24	27	30	33	36	39	42	45	48
Dabrafenib+Trametinib	40	40	34	32	29	25	22	18	13	10	7	6	5	4	3	3	0
Carboplatin+Vincristine	6	6	6	4	4	4	3	2	2	2	0	0	0	0	0	0	0

Data cut: Final analysis data cut, 28th April 2023.

Abbreviations: DOR, duration of response; FAS, full analysis set; LGG, low-grade glioma; PD, progressive disease; RANO, Response Assessment for Neuro-Oncology.

Company evidence submission template for dabrafenib with trametinib for treating *BRAF* V600E mutation-positive glioma in children and young people aged 1 to 17 [ID5104]

Figure 7: Kaplan-Meier plot of DOR by Investigator assessment and using RANO criteria, FAS-LGG

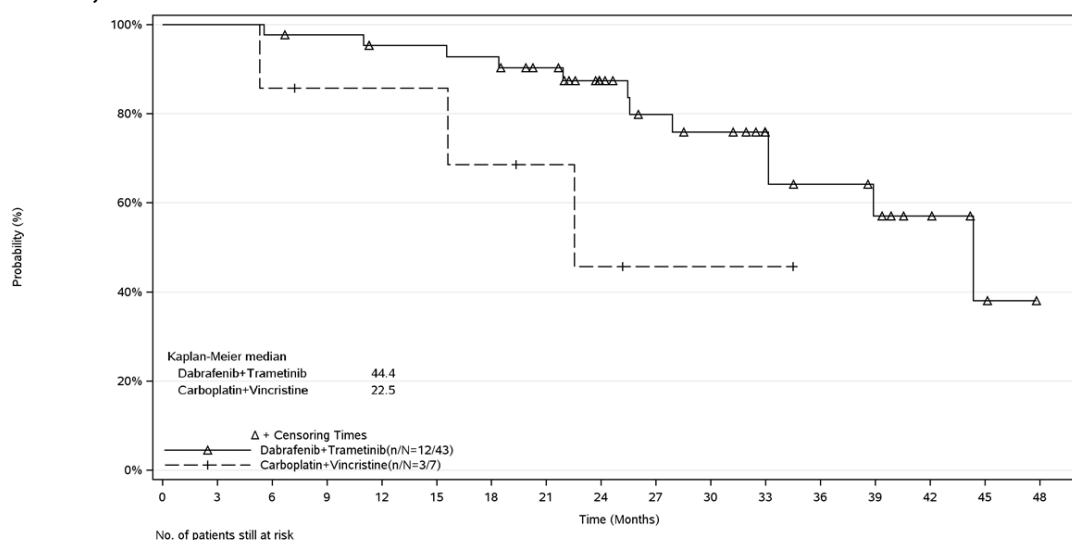

Time (Months)	0	3	6	9	12	15	18	21	24	27	30	33	36	39	42	45	48
Dabrafenib+Trametinib	43	43	42	41	38	38	37	33	25	20	18	13	10	8	5	2	0
Carboplatin+Vincristine	7	7	6	5	5	5	4	3	2	1	1	1	0	0	0	0	0

Data cut: Final analysis data cut, 28th April 2023.

Abbreviations: DOR, duration of response; FAS, full analysis set; LGG, low-grade glioma; PD, progressive disease; RANO, Response Assessment for Neuro-Oncology.

Using descriptive statistics, among patients with a confirmed response, the median time to response (TTR) was 3.7 months vs 4.6 months by independent review and 3.4 months vs 5.7 months by Investigator assessment in the D+T vs the C+V arm, respectively (Appendix N).

B.2.6.2.1.2.3 Progression-free survival based on independent review and investigator review, FAS-LGG (Final analysis data cut)

The D+T arm demonstrated a clinically meaningful benefit in PFS over the C+V arm (Figure 8), with an estimated 64% risk reduction in progression/death (hazard ratio [HR] 0.36; 95% CI: 0.22, 0.59). The median PFS by independent review was longer in the D+T arm (median PFS: 24.9 months; 95% CI: 12.9, 31.6) compared with the C+V arm (median PFS: 7.2 months; 95% CI: 2.8, 11.2) (Table 13). There were 44 patients (60.3%) in the D+T arm and 26 patients (70.3%) in the C+V arm with PFS events; all patients had disease progression (Table 13). Reasons for censoring patients are presented in Appendix N.

Table 13: Kaplan-Meier estimates of PFS based on independent review and Investigator assessment by RANO criteria, FAS-LGG

Estimates	Independent review		Investigator assessment	
	D+T N=73	C+V N=37	D+T N=73	C+V N=37
No. of PFS events – n (%)	44 (60.3)	26 (70.3)	23 (31.5)	15 (40.5)
Progression	44 (60.3)	26 (70.3)	23 (31.5)	15 (40.5)
Death	0	0	0	0

Estimates	Independent review		Investigator assessment	
	D+T N=73	C+V N=37	D+T N=73	C+V N=37
No. censored – n (%)	29 (39.7)	11 (29.7)	50 (68.5)	22 (59.5)
Percentiles (months) for PFS (95% CI)				
25th	9.0 (7.5, 12.8)	2.5 (1.8, 5.1)	31.7 (23.7, 38.6)	3.4 (1.9, 26.1)
50th	24.9 (12.9, 31.6)	7.2 (2.8, 11.2)	46.0 (38.6, NE)	30.8 (7.0, NE)
75th	49.5 (31.6, NE)	13.1 (7.5, 31.3)	NE (40.6, NE)	NE (30.8, NE)
KM event-free estimates (95%CI)				
6 months	87.4 (77.3, 93.3)	54.7 (35.7, 70.3)	93.1 (84.2, 97.1)	71.2 (52.0, 83.9)
12 months	67.7 (55.5, 77.2)	27.4 (13.0, 43.9)	90.3 (80.7, 95.3)	67.9 (48.4, 81.3)
18 months	56.3 (44.0, 66.9)	20.5 (8.4, 36.4)	86.1 (75.7, 92.3)	64.3 (44.7, 78.5)
24 months	52.0 (39.8, 62.9)	20.5 (8.4, 36.4)	83.3 (72.4, 90.1)	60.7 (41.1, 75.5)
30 months	45.3 (33.2, 56.6)	13.7 (3.3, 31.3)	76.4 (64.2, 84.9)	52.0 (32.3, 68.6)
36 months	37.4 (24.9, 49.9)	NE (NE, NE)	65.9 (51.2, 77.1)	44.6 (23.6, 63.7)
42 months	26.7 (12.9, 42.7)	NE (NE, NE)	62.4 (46.8, 74.6)	44.6 (23.6, 63.7)
48 months	26.7 (12.9, 42.7)	NE (NE, NE)	44.9 (21.0, 66.4)	44.6 (23.6, 63.7)
Cox model HR (95% CI)	0.36 (0.22, 0.59)		0.46 (0.24, 0.88)	

Data cut: Final analysis data cut, 28th April 2023.

Abbreviations: C, carboplatin; CI, confidence interval; D, dabrafenib; FAS, full analysis set; HR, hazard ratio; KM, Kaplan-Meier; LGG, low-grade glioma; NE, not estimable; PFS, progression-free survival; RANO, Response-Assessment for Neuro-Oncology; T, trametinib; V, vincristine.

Figure 8: Kaplan-Meier plot of PFS based on independent review and using RANO criteria, FAS-LGG

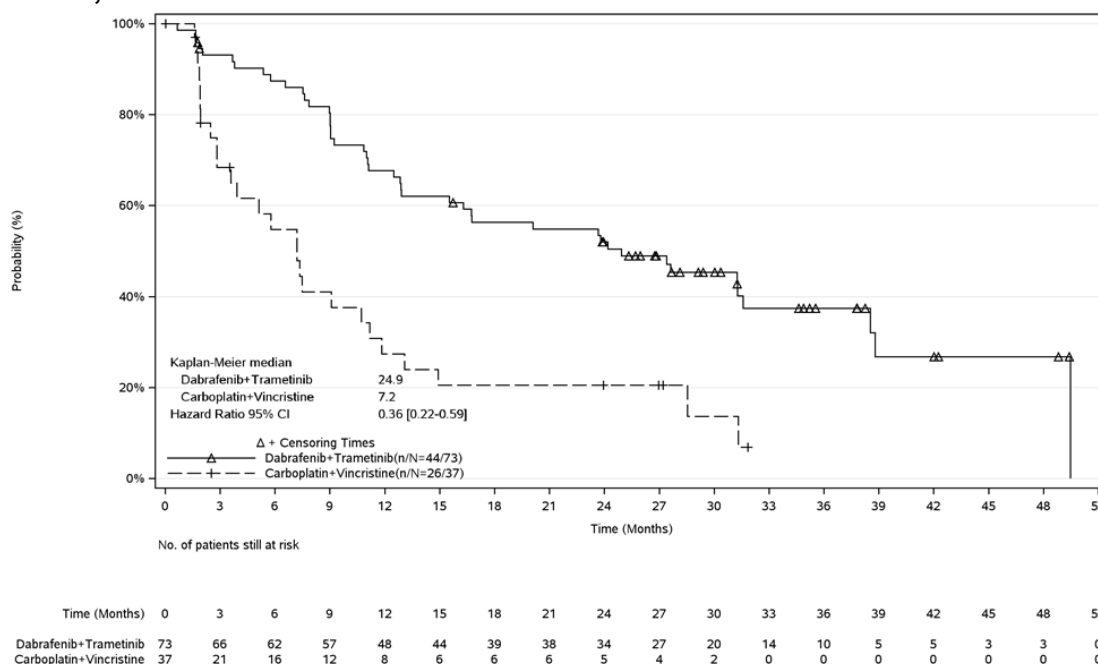

Data cut: Final analysis data cut, 28th April 2023.

Abbreviations: CI, confidence interval; FAS, full analysis set; LGG, low-grade glioma; PFS, progression-free survival; RANO, Response Assessment for Neuro-Oncology.

The Investigator assessment demonstrated that D+T had a clinically meaningful benefit in PFS over the C+V arm, with an estimated 54% risk reduction in progression/death (HR: 0.46; 95% CI: 0.24, 0.88). The PFS KM curves diverged from first assessment onwards, with the event-free probability estimates remaining higher for the D+T arm compared with the C+V arm (Figure 9). Overall, there were fewer PFS events identified by Investigator assessment than by independent review, due to the latter identifying more frequent increases of at least 25% from nadir measurements than the Investigator.

Figure 9: Kaplan- Meier plot of PFS based on Investigator assessment and using RANO criteria, FAS-LGG

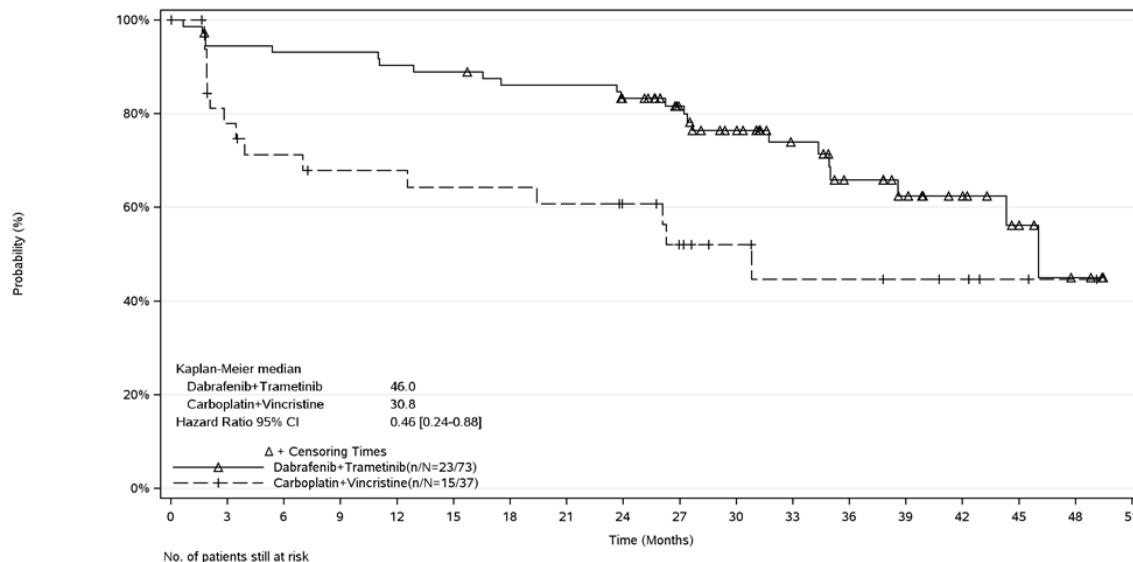

Time (Months)	0	3	6	9	12	15	18	21	24	27	30	33	36	39	42	45	48	51
Dabrafenib+Trametinib	73	68	67	67	65	64	61	61	57	47	39	29	22	17	13	8	3	0
Carboplatin+Vincristine	37	24	21	19	19	18	18	17	15	11	8	6	6	5	4	2	1	0

Data cut: Final analysis data cut, 28th April 2023.

Abbreviations: CI, confidence interval; FAS, full analysis set; LGG, low-grade glioma; NE, not estimable; PFS, progression-free survival; RANO, Response Assessment for Neuro-Oncology.

B.2.6.2.1.2.4 Overall survival (Final analysis data cut)

Data are immature, with no deaths in the D+T arm and one death in the C+V arm. KM estimates of OS in the LGG cohort are presented in Appendix N.

B.2.6.2.1.2.5 Patient-reported outcomes (Final analysis data cut)

The Patient Reported Outcomes Measurement Information Service (PROMIS) Parent Proxy Global Health 7+2 was used to evaluate the QoL of patients between the two treatment arms. The 7+2 item parent proxy paediatric global health measure includes a global health score plus a single score from pain and a score from fatigue interference item which were scored independently. A higher score for global health indicates better overall wellbeing (i.e. physical, mental, and social health); a higher score for pain and fatigue indicates worsening pain and fatigue.

Among patients taking the PROMIS parent proxy questionnaire, ≥82% in the D+T arm and ≥72% in the C+V arm fully completed the questionnaire at the scheduled time points, during the treatment period (final analysis data cut). There was a trend in improvement in global health score over time in the D+T arm compared to the C+V arm. The data are immature and do not meet the criteria for a primary endpoint in the Company evidence submission template for dabrafenib with trametinib for treating BRAF V600E mutation-positive glioma in children and young people aged 1 to 17 [ID5104]

health scores and fatigue scores for the D+T arm compared with the C+V arm at the majority of the scheduled time points. There was no difference in pain scores among patients receiving D+T or C+V (Table 14).

The treatment difference in the overall least squares mean (LSM) of scores between the two treatment arms for global health and fatigue were in favour of the D+T arm over the C+V arm at all scheduled time points. For pain subscale, there was no treatment difference in the overall LSM of scores between the two treatment arms (Table 14).

Table 14: PROMIS Parent Proxy Global Health – Repeated measures analysis, FAS-LGG

Time point	Statistics	D+T N=73	C+V N=37	LSM difference [A-B]
Global health scores				
Week 5 Day 1	n	50	18	–
	LSM (SEM)	42.932 (1.0157)	39.501 (1.6726)	3.431 (1.9569)
	95% CI	40.908, 44.957	36.169, 42.833	–0.468, 7.330
Week 8 Day 1	n	53	18	–
	LSM (SEM)	43.931 (0.9684)	38.093 (1.6261)	5.838 (1.8927)
	95% CI	42.003, 45.859	34.857, 41.328	2.072, 9.605
Week 16 Day 1	n	48	10	–
	LSM (SEM)	44.415 (1.0842)	36.552 (2.1124)	7.863 (2.3743)
	95% CI	42.248, 46.582	32.345, 40.759	3.132, 12.594
Week 24 Day 1	n	46	10	–
	LSM (SEM)	45.819 (1.1657)	35.383 (2.3353)	10.436 (2.6101)
	95% CI	43.491, 48.147	30.733, 40.034	5.236, 15.635
Week 32 Day 1	n	47	11	–
	LSM (SEM)	45.571 (1.0551)	37.176 (2.0337)	8.396 (2.2910)
	95% CI	43.460, 47.682	33.119, 41.232	3.824, 12.968
Week 48 Day 1	n	43	10	–
	LSM (SEM)	44.854 (1.1200)	37.333 (2.1854)	7.521 (2.4557)
	95% CI	42.616, 47.092	32.978, 41.688	2.626, 12.416
End of treatment	n	50	14	–
	LSM (SEM)	45.247 (1.2867)	38.754 (2.3377)	6.493 (2.6684)
	95% CI	42.683, 47.811	34.102, 43.406	1.182, 11.804
Pain scores				
Week 5 Day 1	n	51	18	–
	LSM (SEM)	50.410 (0.9680)	51.099 (1.6275)	–0.689 (1.8937)
	95% CI	48.479, 52.341	47.852, 54.345	–4.466, 3.088
Week 8 Day 1	n	54	18	–
	LSM (SEM)	49.899 (0.8946)	50.254 (1.5573)	–0.356 (1.7957)
	95% CI	48.116, 51.681	47.152, 53.357	–3.933, 3.222
Week 16	n	48	10	–

Time point	Statistics	D+T N=73	C+V N=37	LSM difference [A-B]
Day 1	LSM (SEM)	50.201 (0.9156)	50.879 (1.9848)	-0.678 (2.1865)
	95% CI	48.369, 52.034	46.912, 54.846	-5.048, 3.693
Week 24 Day 1	n	46	10	-
	LSM (SEM)	50.456 (1.0228)	51.313 (2.0596)	-0.857 (2.2994)
	95% CI	48.414, 52.498	47.211, 55.415	-5.439, 3.725
Week 32 Day 1	n	47	11	-
	LSM (SEM)	48.948 (0.9346)	49.042 (1.9001)	-0.094 (2.1176)
	95% CI	47.079, 50.817	45.244, 52.839	-4.326, 4.139
Week 48 Day 1	n	43	10	-
	LSM (SEM)	49.734 (0.9006)	51.182 (1.8181)	-1.449 (2.0299)
	95% CI	47.931, 51.536	47.547, 54.818	-5.508, 2.610
End of treatment	n	50	14	-
	LSM (SEM)	51.530 (0.9384)	53.341 (1.7562)	-1.811 (1.9910)
	95% CI	49.656, 53.404	49.836, 56.845	-5.785, 2.163
Fatigue scores				
Week 5 Day 1	n	51	18	-
	LSM (SEM)	53.733 (0.9113)	56.220 (1.5076)	-2.487 (1.7622)
	95% CI	51.916, 55.549	53.217, 59.223	-5.998, 1.024
Week 8 Day 1	n	54	18	-
	LSM (SEM)	52.989 (0.8296)	57.870 (1.3985)	-4.881 (1.6266)
	95% CI	51.336, 54.642	55.086, 60.653	-8.120, -1.642
Week 16 Day 1	n	48	10	-
	LSM (SEM)	51.798 (0.8567)	58.429 (1.7315)	-6.632 (1.9323)
	95% CI	50.087, 53.508	54.983, 61.876	-10.479, -2.784
Week 24 Day 1	n	46	10	-
	LSM (SEM)	51.746 (1.0240)	55.320 (2.1144)	-3.574 (2.3500)
	95% CI	49.699, 53.794	51.102, 59.539	-8.263, 1.116
Week 32 Day 1	n	47	11	-
	LSM (SEM)	52.931 (0.8658)	57.677 (1.7390)	-4.746 (1.9441)
	95% CI	51.200, 54.661	54.204, 61.149	-8.628, -0.864
Week 48 Day 1	n	43	10	-
	LSM (SEM)	52.602 (1.0222)	53.994 (2.0715)	-1.392 (2.3120)
	95% CI	50.555, 54.648	49.850, 58.138	-6.017, 3.233
End of treatment	n	50	14	-
	LSM (SEM)	52.022 (0.9079)	56.582 (1.6961)	-4.559 (1.9236)
	95% CI	50.210, 53.835	53.198, 59.965	-8.397, -0.721

Data cut: Final analysis data cut, 28th April 2023.

Mixed effects model includes terms for treatment, visit and baseline score as main effects and an interaction term for visit and treatment; The analysis only includes assessment timepoints where there are at least 10 evaluable patients on each of the treatment arms.

Abbreviations: C, carboplatin; CI, confidence interval; D, dabrafenib; FAS, full analysis set; LGG, low-grade glioma; LSM, least squares mean; PROMIS, Patient Reported Outcomes Measurement Information Service; SEM, standard error of the mean; T, trametinib; V, vincristine.

B.2.6.2.2 HGG cohort

B.2.6.2.2.1 Primary endpoint – ORR by independent review, FAS-HGG (Final analysis data cut)

The primary objective met the pre-specified success criteria, i.e. the lower bound of the 95% CI for D+T ORR was greater than the 20% rate as pre-specified threshold in the study protocol. The ORR as determined by independent review in the FAS-HGG was 56.1% (95% CI: 39.7, 71.5; 80% CI: 44.9, 66.8). Similarly, the primary endpoint of ORR by independent review also met the pre-specified threshold of excluding 32% ORR using an 80% CI. Complete response was reported in 14 patients (34.1%) and PR in nine patients (22.0%). The CBR was 65.9% (95% CI: 49.4, 79.9) (Table 15).

ORR by independent review for the primary analysis data cut is presented in Appendix N.

Table 15: Independent reviewer-assessed ORR using RANO criteria, FAS-HGG

	All patients N=41	
	n (%)	95% CI/80% CI
Best overall response		
CR	14 (34.1)	–
PR	9 (22.0)	–
SD	5 (12.2)	–
PD	10 (24.4)	–
Unknown	3 (7.3)	–
ORR:CR+PR	23 (56.1)	39.7, 71.5/44.9, 66.8
CBR:CR+PR+SD	27 (65.9)	49.4, 79.9/NA

Data cut: Final analysis data cut, 28th April 2023

Abbreviations: CBR, clinical benefit rate; CI, confidence interval; CR, complete response; FAS, full analysis set; HGG, high-grade glioma; NA, not applicable; ORR, overall response rate; PD, progressive disease; PR, partial response; RANO, Response-Assessment for Neuro-Oncology; SD, stable disease.

B.2.6.2.2.2 Secondary endpoints

B.2.6.2.2.2.1 ORR by Investigator assessment, FAS-HGG (Final analysis data cut)

The ORR by Investigator assessment in the FAS-HGG was 61.0% (95% CI: 44.5, 75.8; 80% CI: 49.8, 71.3), with a CR reported in 12 patients (29.3%) and PR in 13 patients (31.7%). The CBR was 75.6% (95% CI: 59.7, 87.6, 80% CI: NA) (Table 16).

Table 16: Investigator assessed ORR using RANO criteria, FAS-HGG

	All patients N=41	
	n (%)	95% CI/80% CI
Best overall response		
CR	12 (29.3)	–
PR	13 (31.7)	–
SD [†]	6 (14.6)	–
PD	9 (22.0)	–
Unknown	1 (2.4)	–
ORR: CR+PR	25 (61.0)	(44.5, 75.8)/(49.8, 71.3)
CBR: CR+PR+SD	31 (75.6)	(59.7, 87.6)/NA

Data cut: Final analysis data cut, 28th April 2023.

Abbreviations: CBR, clinical benefit rate; CI, confidence interval; CR, complete response; FAS, full analysis set; HGG, high-grade glioma; NA, not applicable; ORR, overall response rate; PD, progressive disease; PR, partial response; RANO, Response-Assessment for Neuro-Oncology; SD, stable disease.

B.2.6.2.2.2 Duration of response by independent review and Investigator assessment, FAS-HGG (Final analysis data cut)

Observed responses were durable with D+T. The median DOR by independent review was 27.4 months (95% CI: 9.2, NE) and by Investigator assessment was 32.7 months (95% CI: 14.9, NE). Twelve patients continued to be in response by independent review and 13 patients by investigator assessment at the time of the final data cut. The KM-estimated 4-month event-free rate (i.e. the proportion of responders still in response) was 90.9% (95% CI: 68.3, 97.6) by independent review and 95.8% (95% CI: 73.9, 99.4) by Investigator assessment (Table 17). Reasons for censoring patients are presented in Appendix N.

Table 17: Kaplan-Meier estimates of DOR by independent review and Investigator assessment based on RANO criteria, FAS-HGG

Estimates	All patients N=41	
	Independent review	Investigator assessment
No. of responders – n (%)	23 (56.1)	25 (61.0)
No. of events	11 (47.8)	12 (48.0)
No. of censored	12 (52.2)	13 (52.0)
Percentiles (months) (95% CI)		
25 th	9.2 (3.5, 22.2)	13.8 (3.5, 31.3)
50 th	27.4 (9.2, NE)	32.7 (14.9, NE)
75 th	NE (27.4, NE)	NE (36.0, NE)
KM event-free estimates (95% CI)		
4 months	90.9 (68.3, 97.6)	95.8 (73.9, 99.4)
6 months	86.4 (63.4, 95.4)	91.7 (70.6, 97.8)
12 months	63.3 (39.8, 79.7)	82.9 (60.7, 93.2)
18 months	58.4 (35.2, 75.8)	69.1 (45.8, 84.0)
24 months	52.6 (29.5, 71.3)	64.5 (41.3, 80.5)

Company evidence submission template for dabrafenib with trametinib for treating BRAF V600E mutation-positive glioma in children and young people aged 1 to 17 [ID5104]

Estimates	All patients N=41	
	Independent review	Investigator assessment
30 months	45.1 (22.0, 65.7)	59.5 (36.4, 76.6)

Data cut: Final analysis data cut, 28th April 2023.

Event: progression disease or death due to any cause.

Abbreviations: BOR, best overall response; CI, confidence interval; CR, complete response; DOR, duration of response; FAS, full analysis set; HGG, high-grade glioma; KM, Kaplan-Meier; NE, not estimable; PR, partial response; RANO, Response-Assessment for Neuro-Oncology.

Kaplan-Meier plots of DOR by independent review and by Investigator assessment are presented in Figure 10 and Figure 11, respectively. Swimmer plots for time to onset and DOR by independent review and Investigator assessment are presented in Appendix N.

Figure 10: Kaplan-Meier plot of DOR by independent review based on RANO criteria, FAS-HGG

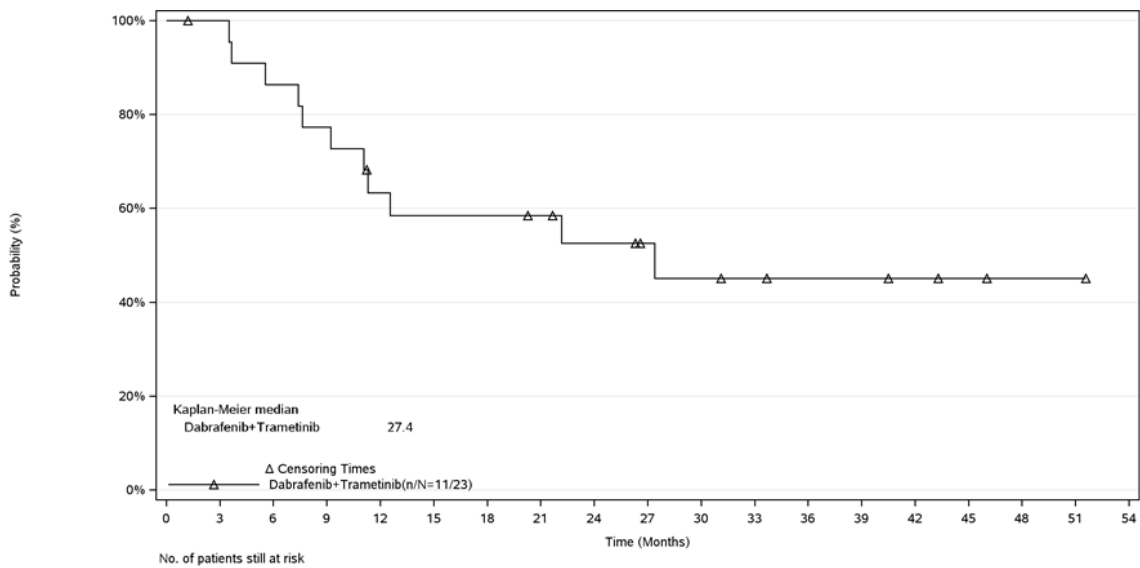

Time (Months)	0	3	6	9	12	15	18	21	24	27	30	33	36	39	42	45	48	51	54
Dabrafenib+Trametinib	23	22	19	17	13	12	12	11	9	7	6	5	4	4	3	2	1	1	0

Data cut: Final analysis data cut, 28th April 2023.

Abbreviations: DOR, duration of response; FAS, full analysis set; HGG, high-grade glioma; RANO, Response Assessment for Neuro-Oncology.

Figure 11: Kaplan-Meier plot of DOR by Investigator assessment based on RANO criteria, FAS-HGG

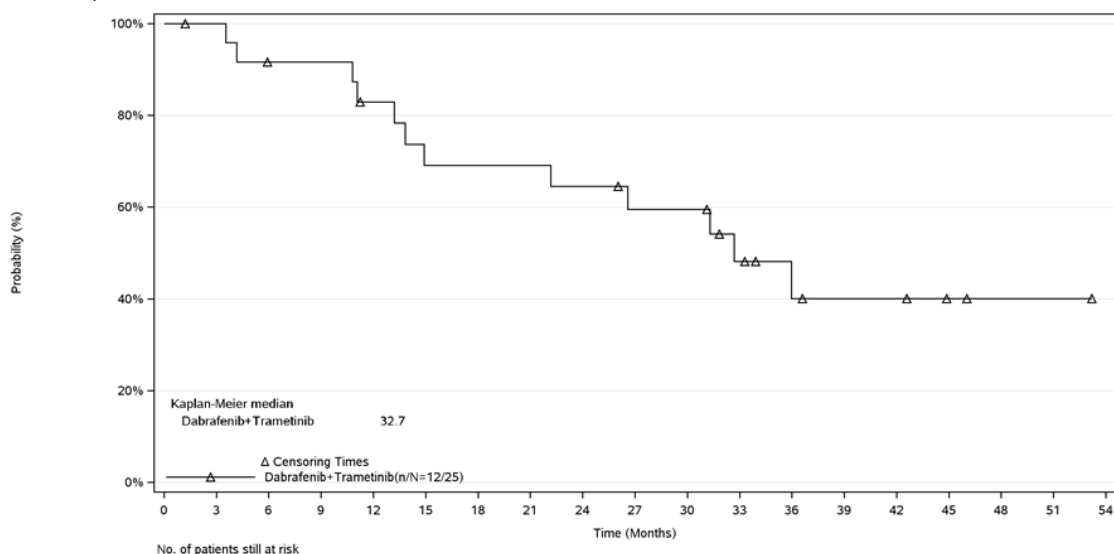

Time (Months)	0	3	6	9	12	15	18	21	24	27	30	33	36	39	42	45	48	51	54
Dabrafenib+Trametinib	25	24	21	21	18	15	15	15	14	12	12	8	5	4	4	2	1	1	0

Data cut: Final analysis data cut, 28th April 2023.

Abbreviations: DOR, duration of response; FAS, full analysis set; HGG, high-grade glioma; RANO, Response Assessment for Neuro-Oncology.

Responses were observed early in the course of treatment with D+T. Using descriptive statistics, among patients with confirmed response, the median TTR by independent review was 1.9 months (range: 1.0, 10.9) and by Investigator assessment 1.7 months (range: 0.9, 23.6) (Appendix N).

B.2.6.2.2.3 Progression-free survival by independent review and Investigator assessment (Final analysis data cut)

The median PFS was 9.0 months (95% CI: 5.3, 20.1) by independent review and 24.0 months (95% CI: 12.5, NE) by Investigator assessment (Table 18), with 14 patients (34.1%) by independent review and 17 patients (41.5%) by Investigator assessment without an event (Appendix N). By independent review, the KM-estimated 6-month and 12-month event-free rates were 67.0% (95% CI: 49.9, 79.3) and 45.5% (95% CI: 29.4, 60.3), and 70.3% (95% CI: 53.6, 81.9) and 67.8% (95% CI: 51.1, 79.9), by Investigator assessment, respectively (Table 18). The Independent reviewer identified increases from nadir measurements that met the RANO criteria for progression of disease earlier than the Investigators.

Kaplan-Meier plots of PFS by independent review and by Investigator assessment are presented in Figure 12 and Figure 13, respectively.

Table 18: Kaplan-Meier estimates of PFS per independent review and Investigator assessment based on RANO criteria, FAS-HGG

Estimates	All patients N=41	
	Independent review	Investigator assessment
No. of PFS events, n (%)	27 (65.9)	24 (58.5)
Progression	24 (58.5)	23 (56.1)
Death	3 (7.3)	1 (2.4)
No. censored, n (%)	14 (34.1)	17 (41.5)
Percentiles (months) for PFS (95% CI)		
25 th	3.6 (1.7, 7.2)	5.4 (1.6, 12.6)
50 th	9.0 (5.3, 20.1)	24.0 (12.5, NE)
75 th	NE (12.9, NE)	NE (34.6, NE)
KM event-free estimates (95%CI)		
6 months	67.0 (49.9, 79.3)	70.3 (53.6, 81.9)
12 months	45.5 (29.4, 60.3)	67.8 (51.1, 79.9)
18 months	37.0 (21.9, 52.1)	52.3 (35.8, 66.4)
24 months	34.1 (19.6, 49.3)	52.3 (35.8, 66.4)
30 months	31.3 (17.3, 46.4)	47.1 (31.0, 61.6)
36 months	27.4 (13.9, 42.8)	40.4 (24.6, 55.6)

Data cut: Final analysis data cut, 28th April 2023.

Abbreviations: CI, confidence interval; FAS, full analysis set; HGG, high-grade glioma; KM, Kaplan-Meier; NE, not estimable; PFS, progression-free survival; RANO, Response-Assessment for Neuro-Oncology.

Figure 12: Kaplan-Meier plot of PFS per independent review based on RANO criteria, FAS-HGG

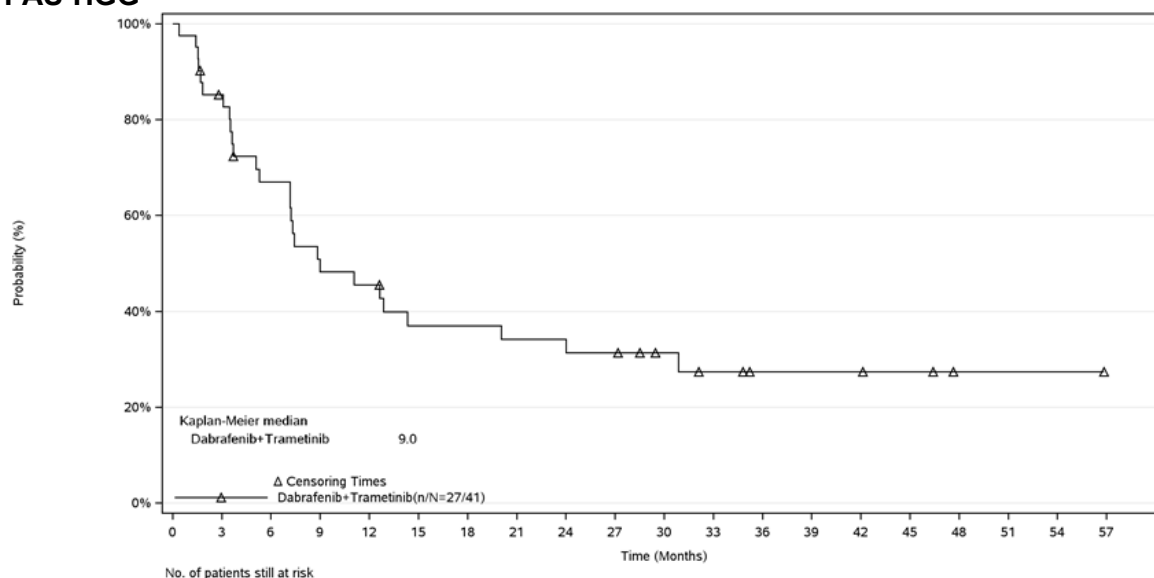

Data cut: Final analysis data cut, 28th April 2023.

Abbreviations: FAS, full analysis set; HGG, high-grade glioma; PFS, progression-free survival; RANO, Response Assessment for Neuro-Oncology.

Figure 13: Kaplan-Meier plot of PFS per Investigator assessment based on RANO criteria, FAS-HGG

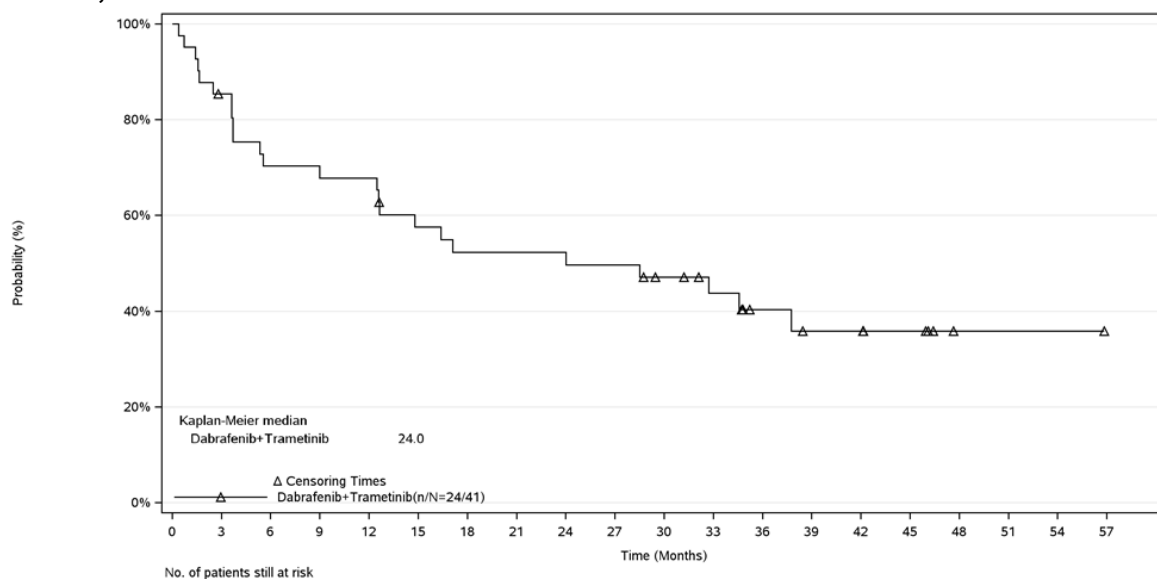

Data cut: Final analysis data cut, 28th April 2023.

Abbreviations: FAS, full analysis set; PFS, progression-free survival; HGG, high-grade glioma; RANO, Response Assessment for Neuro-Oncology.

B.2.6.2.2.2.4 Overall survival, FAS-HGG (Final analysis data cut)

The OS data were immature at the time of the final analysis. Among the 41 patients, 17 patients (41.5%) died, and 24 patients (58.5%) were censored at the time of the final data cut. The estimated OS rates at 12 and 24 months were 77.0% (95% CI: 60.4, 87.3) and 61.0% (95% CI: 43.8, 74.4) (Table 19). The KM plot of OS is provided in Figure 14.

Table 19: Kaplan-Meier estimates of OS, FAS-HGG

Estimates	All patients N=41
No. of deaths, n (%)	17 (41.5)
No. censored, n (%)	24 (58.5)
Percentiles (months) for OS (95% CI)	
25 th	14.3 (5.5, 23.8)
50 th	NE (19.8, NE)
75 th	NE (NE, NE)
KM event-free estimates (95%CI)	
6 months	87.4 (72.4, 94.6)
12 months	77.0 (60.4, 87.3)
18 months	71.7 (54.6, 83.2)
24 months	61.0 (43.8, 74.4)
30 months	58.4 (41.3, 72.1)
36 months	55.1 (37.9, 69.4)

Estimates	All patients N=41
42 months	55.1 (37.9, 69.4)

Data cut: Final analysis data cut, 28th April 2023.

Abbreviations: CI, confidence interval; FAS, full analysis set; HGG, high-grade glioma; KM, Kaplan-Meier; NE, not estimable; OS, overall survival.

Figure 14: Kaplan-Meier plot of OS, FAS-HGG

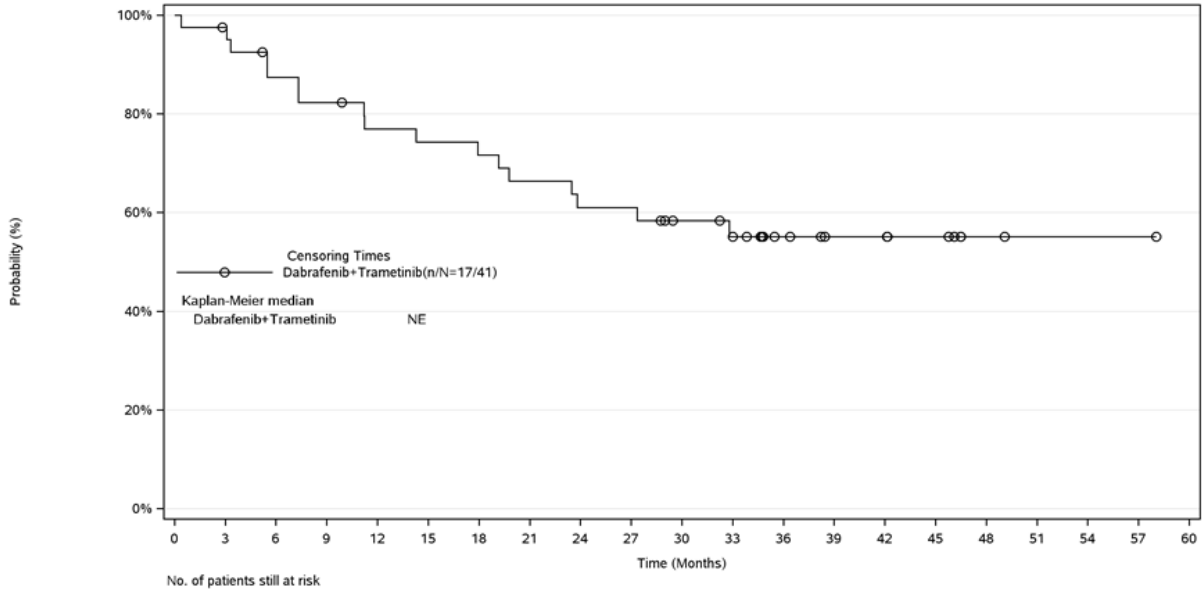

Data cut: Final analysis data cut, 28th April 2023.

Abbreviations: FAS, full analysis set; HGG, high-grade glioma; NE, not estimable; OS, overall survival.

B.2.7 Subgroup analysis

For each of the subgroups, the proportion of patients with objective response and the two-sided exact 95% were provided. A forest plot (n, odds ratio, 95% CI) was produced to graphically depict the treatment effect estimates in different subgroups. No inferential statistics (p-value) were produced for the subgroups.

B.2.7.1 ORR, LGG cohort

The subgroup analyses of ORR demonstrated results in favour of the D+T arm over the C+V arm in the radiographic progression subgroup. It should be noted that the number of patients with gross total resection was very low (n=█), and █ patients were in the D+T arm (Figure 15).

Figure 15: Forest plot of ORR odds ratio by independent assessment by subgroups, FAS-LGG

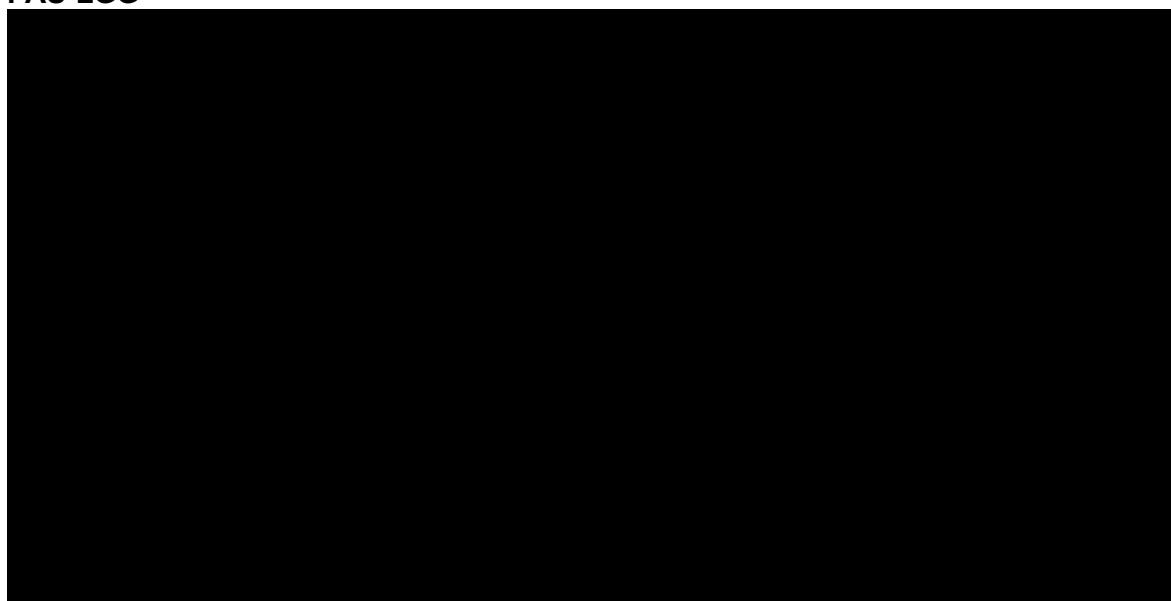

Data cut: Final analysis data cut, 28th April 2023.

Abbreviations: C, carboplatin; CI, confidence interval; D, dabrafenib; FAS, full analysis set; LGG, low-grade glioma; NE, not estimable; ORR, overall response rate; T, trametinib; V, vincristine.

B.2.8 Meta-analysis

Pairwise meta-analysis was not possible from the available data.

B.2.9 Indirect and mixed treatment comparisons

In the absence of head-to-head trials, the relative efficacy of D+T vs TMZ was derived using an indirect treatment comparison (ITC). Given the single-arm trial design of TADPOLE, unanchored matching-adjusted indirect comparisons (MAIC) and inverse of probability of treatment weighting (IPTW) methodology were utilised to derive the relative efficacy of D+T vs TMZ. The efficacy outcomes compared were OS, PFS, and ORR. Additional outcomes of interest were DOR and HRQoL, however ITCs for these two endpoints were not possible due to the lack of TMZ data. The key results from MAIC analyses for the TMZ-naïve population are summarised below, and further details for these analyses, as well as the results for alternative scenarios and the treatment comparison in the all-patient population, are provided in Appendix D.

B.2.9.1 Overview of the methodology

The methodology used to derive the relative efficacy of D+T vs TMZ were unanchored MAICs and IPTW. Population-adjustment comparisons via MAIC methods utilised individual patient data (IPD) from TADPOLE for D+T, and published aggregate data for TMZ. These methods are in line with the published guidance in NICE Decision Support Unit (DSU) Technical Support Document (TSD) 18, and Phillippo 2018 (72, 73). Population adjustment comparisons via IPTW methods utilised IPD from TADPOLE for D+T, and published IPD for TMZ. These methods are in line with the published guidance in NICE DSU TSD 17 (74).

The MAIC approach adjusted for baseline differences in potential prognostic factors and treatment effect modifiers by re-weighting the available IPD for D+T to match the average baseline characteristics of TMZ, for which only aggregate data are reported. MAIC is a non-parametric likelihood reweighting method that allows a propensity score logistic regression model to be estimated with the potential prognostic factors and treatment effect modifiers as predictors in the model.

The IPTW approach also adjusted for baseline differences in confounding factors between two populations by reweighting both the available D+T and TMZ IPD, so that the available confounding factors were equally distributed across the two groups. Weights were assigned to all patients from TADPOLE and the comparator IPD, based on the inverse of their probability of receiving D+T derived using their propensity score. Propensity scores were estimated using a logistic regression model in which treatment assignment were regressed upon patient baseline characteristics (independent variables). The regression model included all confounding factors related to treatment assignment and to outcome (potential prognostic factors and treatment effect modifiers).

Re-weighting the IPD through MAIC methods or IPTW in this way can reduce (or remove) observed imbalances in patient characteristics between two treatments. Outcomes for each treatment can then be compared between the balanced trial populations. Further details of the methodology are presented in Appendix D.

B.2.9.2 Evidence base

The SLR reported in Section B.2.1 and Appendix D identified seven studies reporting TMZ which were considered for inclusion in the ITCs. Table 20 summarises the three studies (TADPOLE and two TMZ studies) which were deemed relevant and were included in the ITC, the reasons for exclusion for the remaining five TMZ studies are summarised in Appendix D.

As IPD were available for TADPOLE, as well as for PFS and ORR outcomes from Verschuur 2004 (66), an IPTW methodology was utilised for PFS and ORR comparisons with this study. Aggregate data were available for OS in Verschuur 2004 and ORR from Lashford 2002 (62), therefore, the MAIC method was utilised for the remaining ITCs.

Table 20: Summary of studies included in the ITC analyses

Study name	Sample size	Treatment	Study design	Endpoints	Data available
TADPOLE (39)	41	Dabrafenib + trametinib	Phase 2, single-arm, open-label multicentre study	OS, PFS, ORR	IPD
Lashford 2002 (62)	55 (34 with HGG)	TMZ	Phase 2 multicentre study	ORR	Aggregate

Study name	Sample size	Treatment	Study design	Endpoints	Data available
Verschuur 2004 (66)	20 (15 treated after radiotherapy and 5 treated prior to radiotherapy)	TMZ	Single centre [†] study	OS, PFS, ORR	IPD for PFS and ORR Aggregate data for OS

[†]Unclear where the single centre was however the correspondence was for Department of Paediatric Oncology, Academic Medical Centre, University of Amsterdam, Emma Childrens' Hospital.
Abbreviations: HGG, high-grade glioma; IPD, individual patient data; ITC, indirect treatment comparison; PFS, progression-free survival; ORR, overall response rate; OS, overall survival; TMZ, temozolomide; UKCCG/SFOP, United Kingdom Children's Cancer Study Group/ Pharmacology Group of the French Pediatric Oncology Society.

B.2.9.2.1 Inclusion/exclusion criteria

A summary of the inclusion/exclusion criteria of the studies are provided in Appendix D, with key differences highlighted below:

- TADPOLE enrolled patients with *BRAF* V600 mutation; neither Lashford 2002, nor Verschuur 2004 measured *BRAF* V600 status
- All included studies enrolled paediatric and adolescent patients, however the upper and lower limit of age varied between studies. Age inclusion/exclusion criterion were considered during population trimming, before the population adjustment, to ensure trials included the same age of patients, where possible
- Verschuur 2004 excluded patients with brainstem glioma. Therefore, patients from TADPOLE with brainstem glioma were excluded during population trimming for comparisons with Verschuur 2004.

B.2.9.2.2 Baseline characteristics and outcome definitions

A summary of the baseline characteristics are provided in Appendix D. However, key differences included:

- Verschuur 2004 enrolled one patient with WHO Grade II glioma. This patient was excluded from the analyses, where sample size was not prohibitively small
- TADPOLE enrolled patients with diffuse midline glioma (DMG). As neither Lashford 2002 nor Verschuur 2004 enrolled DMG patients, these TADPOLE patients were excluded from the comparative analyses.

Outcome definitions were comparable across the studies and are provided in Appendix D.

B.2.9.3 Identification of prognostic factors and treatment effect modifiers

Prognostic variables and treatment-effect modifiers were required for use as covariates in the analyses.

Patients in TADPOLE were allowed to receive prior TMZ. As this was identified as a potential prognostic factor, analyses were conducted in a TMZ-naïve subgroup of TADPOLE, as well as the overall population. The availability of prognostic factors included in

the evidence base is presented in Table 21. Additional information about the identification and selection of these factors is provided in Appendix D.

Table 21: Availability of prognostic factors in HGG in the included studies

	TADPOLE	Lashford 2002	Verschuur 2004
Tumour histologic grade	✓	✓	✓
Extent of resection	✓	×	Prior surgery
Prior radiotherapy	✓	All patients had prior radiotherapy	✓
Prior chemotherapy	✓	✓	✓
Karnofsky / Lansky PS	✓	×†	×
DMG histology subtype	✓	✓	✓
Age	✓	✓	✓

†Study inclusion required that patients had “adequate” PS as measured using the Karnofsky or Lansky play scale. However, baseline PS was reported on a scale of 0-4, so it was not possible to match the definitions of PS between the studies

Abbreviations: DMG, diffuse midline glioma; HGG, high-grade gliomas; PS, performance status.

B.2.9.4 Data extraction and variable generation

The percentage of OS over time was extracted from the published KM curves in Verschuur 2004, using Engauge Digitizer 10.4, and pseudo-IPD were reconstructed using the algorithm published by Guyot 2012 (75). ORR was extracted from Lashford 2002 in the form of the number of patients with an event, total number of patients in the relevant treatment arm, and the percentage of patients with an event (where reported). Appendix D provides a summary of the available median OS and PFS, as well as ORR reported for each included study.

Table 22 presents the baseline characteristics of studies used in the MAICs.

Table 22: Baseline characteristics of included studies

Study name	TADPOLE (IPD available)	Lashford 2002	Verschuur 2004 (IPD available)
Treatment	D+T	TMZ	TMZ
Population	HGG	HGG (eligible study Arm A)	HGG
N	41	25	20
Age; median (range)	13 (2, 17)	13 (4.2, 17.5)	10.0 (3, 20.5)
Sex; n (%)			
Male	18 (43.9)	12 (48.0)	NR
Female	23 (56.1)	13 (52.0)	NR
Race/Ethnicity; n (%)			
White	25 (61.0)	NR	NR
Asian	11 (26.8)	NR	NR
Black or African American	1 (2.4)	NR	NR

Study name	TADPOLE (IPD available)	Lashford 2002	Verschuur 2004 (IPD available)
Other	4 (9.8)	NR	NR
WHO tumour grade (central histology); n (%)			
Grade II	██████	-	1 (5.0)
Grade III	██████	14 (56.0)	11 (55.0)
Grade IV	██████	10 (40.0)	8 (40.0)
Other	██████████	1 (4.0)	0 (0)
KPS or Lansky index score; n (%)			
<70	5 (12.2)	NR	NR
70-80	8 (19.5)	NR	NR
90-100	28 (68.3)	NR	NR
PS; n (%)			
0	NR	8 (32.0)	NR
1	NR	8 (32.0)	NR
2	NR	5 (20.0)	NR
3	NR	3 (12.0)	NR
Prior surgery; n (%)	40 (97.6)	NR	16 (80.0)
Prior radiation therapy; n (%)	37 (90.2)	25 (100.0)	14 (70.0)
Prior chemotherapy; n (%)	33 (80.5)	11 (44.0)	10 (50.0)

Abbreviations: CNS, central nervous system; D, dabrafenib; HGG, high-grade glioma; IPD, individual patient data; KPS, Karnofsky performance score; NR, not reported; PS, performance score; T, trametinib; TMZ, temozolomide; WHO, World Health Organization.

B.2.9.5 ITC analyses conducted

Table 23 provides an overview of the ITC analyses conducted to compare D+T with TMZ; analyses were conducted for all patients in the studies, regardless of TMZ status at study enrolment, and for the subgroup of patients who had not received prior TMZ. Analyses in a subgroup of patients who were pre-treated with TMZ was not possible, as the comparator studies enrolled a very small number of prior TMZ-treated patients (Verschuur 2004 reported that five patients received TMZ at initial diagnosis while awaiting radiotherapy after having had a resection or a biopsy). In addition, the data for this subgroup were not reported separately. The TMZ-naïve subgroup was the population of primary interest for the model.

Table 23: ITC analyses conducted

Comparator study	Endpoint	Method	Matching variables	Trimming (TMZ-naïve and all patients analyses)	Additional trimming for TMZ-naïve population analyses	Notes			
			Main analyses (TADPOLE TMZ-naïve patients)						
Verschuur 2004 (66)	OS	MAIC	<ul style="list-style-type: none"> Age Prior radiotherapy Prior chemotherapy Tumour grade (sensitivity analysis only) 	<ul style="list-style-type: none"> Excluded 4 patients from TADPOLE with DMG† Excluded 1 patient with missing prior surgery data from TADPOLE Excluded 1 patient with missing prior chemotherapy data from TADPOLE Excluded 11 patients from TADPOLE with missing centrally assessed tumour grade data (tumour grade analysis only, base case includes these patients) 	<ul style="list-style-type: none"> Excluded patients with prior TMZ from TADPOLE 	<ul style="list-style-type: none"> Limitation was that Verschuur 2004 could enrol slightly older patients; 4 patients enrolled were older than 18 years old, the limit in TADPOLE In Verschuur 2004, 1 patient was Grade II and had longer PFS (34+ months compared with the next highest at 14 months), therefore this patient is likely to have longer OS compared with the other patients enrolled Verschuur 2004 had a small sample size of 20 patients (15 treated after radiotherapy and 5 treated prior to radiotherapy) 			
	PFS	IPTW					<ul style="list-style-type: none"> Excluded 4 patients from Verschuur 2004 who are older than 18 years olds Excluded 5 patients from Verschuur 2004 who had no prior surgery Excluded 4 patients from TADPOLE with DMG† Exclude 1 patient with missing prior surgery data from TADPOLE Excluded 1 patient with missing prior chemotherapy data from TADPOLE 	<ul style="list-style-type: none"> Excluded patients with prior TMZ from TADPOLE 	<ul style="list-style-type: none"> Limitation that excluding patients from Verschuur 2004 dataset leads to a small comparator set of just 11 patients (8 treated after radiotherapy and 3 treated prior to radiotherapy)
	ORR								

Company evidence submission template for dabrafenib with trametinib for treating *BRAF* V600E mutation-positive glioma in children and young people aged 1 to 17 [ID5104]

Comparator study	Endpoint	Method	Matching variables	Trimming (TMZ-naïve and all patients analyses)	Additional trimming for TMZ-naïve population analyses	Notes
				<ul style="list-style-type: none"> Excluded 11 patients from TADPOLE with missing centrally assessed tumour grade data (tumour grade analysis only, base case includes these patients) 		
Lashford 2002 (62)	ORR	MAIC	<ul style="list-style-type: none"> Age Prior chemotherapy 	<ul style="list-style-type: none"> Excluded 4 patients from TADPOLE with DMG† (1 patient also has missing chemotherapy data) Excluded 4 patients who have not had prior radiotherapy (2 patients are also < 3 years old) Excluded 1 patient with missing prior chemotherapy data from TADPOLE 	<ul style="list-style-type: none"> Excluded patients with prior TMZ from TADPOLE 	<ul style="list-style-type: none"> Lashford 2002 had a small sample size of 25 patients

Abbreviations: DMG, diffuse midline glioma; IPTW, inverse probability of treatment weighting; MAIC, matching-adjusted indirect comparison; ORR, overall response rate; OS, overall survival; PFS, progression free survival; PS, performance score; TMZ, temozolomide.

B.2.9.6 Results

Comparisons with the Verschuur 2004 study are presented as the main analyses, due to the availability of IPD for PFS and ORR and greater availability of matching variables and reported outcomes, compared with those in Lashford 2002. In addition, the focus is on the comparative results for the subgroup of patients who are TMZ-naïve, to align with the data from the ITC used in the economic modelling. Results of the comparisons for the all-patient group (regardless of prior TMZ status) and ORR comparisons for both TADPOLE vs Verschuur 2004 and TADPOLE vs Lashford 2002, are presented in Appendix D.

Verschuur 2004 OS MAIC comparison – TMZ-naïve patient subgroup

Table 24 presents the TADPOLE HGG TMZ-naïve cohort (unadjusted and weighted) and Verschuur 2004 study baseline characteristics for the base case. Matching was based on age (mean), prior radiotherapy (%) and prior chemotherapy (%). The ESS was around one-third smaller than the original sample size.

Table 24: Comparison of baseline characteristics (TMZ-naïve subgroup): MAIC D+T (TADPOLE) vs TMZ (Verschuur 2004)

Treatment (study)	N/ESS	Age (mean)	Prior radiotherapy (%)	Prior ChT (%)
D+T unadjusted (TADPOLE)	■	■	■	■
D+T weighted (TADPOLE)	■	12.0	70.0	50.0
TMZ (Verschuur 2004)	20	12.0	70.0	50.0

Abbreviations: ChT, chemotherapy; D, dabrafenib; ESS, effective sample size; MAIC, matching-adjusted indirect comparison; N, sample size; T, trametinib; TMZ, temozolomide.

The KM plots for OS for TMZ-naïve patients receiving D+T for the unadjusted and weighted patient data, compared with patients receiving TMZ are shown in Figure 16. Median OS for D+T patients was not reached in the pre- or post-weighting estimates (Table 25), with patients treated with D+T experiencing significantly longer OS in both pre- and post-weighting analyses. Findings from an assessment of the validity of the proportional hazards assumption are presented in Appendix D.

In summary, the OS MAIC results demonstrated that TMZ-naïve patients receiving D+T experienced significantly longer OS compared with patients receiving TMZ (HR < 1.0 and 95% CI did not contain 1.0). The adjusted HR was similar compared with the unadjusted HR; therefore, the conclusions pre- and post-weighting were the same. Due to the small sample size across both groups of patients, the OS results were associated with relatively large CIs both pre- and post-weighting.

Figure 16: Kaplan-Meier plot for OS MAIC (TMZ-naïve subgroup): D+T matched with TMZ patient characteristics (Verschuur 2004)



Abbreviations: D, dabrafenib; MAIC, matching-adjusted indirect comparison; OS, overall survival; T, trametinib; TMZ, temozolomide.

Table 25: Summary of OS MAIC (TMZ-naïve subgroup): D+T (TADPOLE) vs TMZ (Verschuur 2004)

Treatment (study)	N/ESS	Events	Median OS, months (95% CI)	D+T vs TMZ HR (95% CI)
D+T naïve comparison	■	■	■	■
D+T weighted	■	■	■	Standard: ■ Bootstrap: ■
TMZ	20	16	8.53 (2.98, 18.95)	Comparator

Bold indicates a significant difference between treatments.

Abbreviations: CI, confidence interval; D, dabrafenib; ESS, effective sample size; HR, hazard ratio; MAIC, matching-adjusted indirect comparison; NE, not evaluable; OS, overall survival; T, trametinib; TMZ, temozolomide.

Verschuur 2004 PFS IPTW comparison – TMZ-naïve patient subgroup

Table 26 presents the unadjusted and weighted TMZ-naïve TADPOLE cohort and Verschuur 2004 study baseline characteristics. Matching was based on age (mean), prior radiotherapy (%) and prior chemotherapy (%).

Table 26: Comparison of baseline characteristics (TMZ-naïve subgroup): IPTW D+T (TADPOLE) vs TMZ (Verschuur 2004)

Treatment (study)	N	Age (mean)	Prior radiotherapy (%)	Prior ChT (%)
D+T unadjusted (TADPOLE)	■	■	■	■
TMZ unadjusted (Verschuur 2004)	11	10.8	72.7	63.6
D+T weighted (TADPOLE)	■	■	■	■

Treatment (study)	N	Age (mean)	Prior radiotherapy (%)	Prior ChT (%)
TMZ weighted (Verschuur 2004)	█	█	█	█

Abbreviations: ChT, chemotherapy; D, dabrafenib; IPTW, inverse probability of treatment weighting; N, sample size; T, trametinib; TMZ, temozolomide.

The KM plots for PFS for patients for the unadjusted and weighted patient data for D+T and TMZ are shown in Figure 17. The weighting had only a small impact on PFS for both D+T and TMZ patients, which was reflected in the identical HR estimates pre- and post-weighting (Table 27). Patients treated with D+T experienced significantly longer PFS in both pre- and post-weighting analyses. Findings from an assessment of the validity of the proportional hazards assumption are presented in Appendix D.

Figure 17: Kaplan-Meier plot for PFS IPTW (TMZ-naïve subgroup): D+T matched with TMZ patient characteristics (Verschuur 2004)



Abbreviations: D, dabrafenib; IPTW, inverse probability of treatment weighting; PFS, progression-free survival; T, trametinib; TMZ, temozolomide.

Table 27: Summary of PFS IPTW (TMZ-naïve subgroup): D+T (TADPOLE) vs TMZ (Verschuur 2004)

Treatment (study)	N	Events	Median PFS, months (95% CI)	D+T vs TMZ HR (95% CI)
D+T naïve comparison	█	█	█	█
TMZ unweighted	11	11	2.0 (1.5, NE)	Comparator
D+T weighted	█	█	█	Robust SE: █
TMZ weighted	█	█	█	Comparator

Bold indicates a significant difference between treatments.

Abbreviations: CI, confidence interval; D, dabrafenib; HR, hazard ratio; IPTW, inverse probability of treatment weighting; NE, not evaluable; PFS, progression-free survival; SE, standard error; T, trametinib; TMZ, temozolomide.

In summary, the PFS IPTW results demonstrated that TMZ-naïve patients receiving D+T experienced statistically significantly longer PFS compared with patients receiving TMZ (HR <1.0 and 95% CI did not contain 1.0). The weighting had a small impact on PFS for both D+T- and TMZ-treated patients, which was reflected in the identical HR estimates pre- and post-weighting. Due to the small sample size across both groups of patients, the PFS results were associated with relatively large CIs both pre- and post-weighting.

B.2.9.7 Uncertainties in the indirect and mixed treatment comparisons

The above analyses are associated with uncertainty due to data availability, some differences in prognostic factors available from each study, along with small sample sizes for the treatment groups included in the analyses.

The small sample sizes in each treatment group is a challenge in this treatment indication, with only 41 patients with HGG recruited in the TADPOLE trial and a maximum of 33 patients included in any of the seven TMZ studies identified in the SLR, with only ≤25 patients included in the studies most suitable for comparison in the ITC. Such small sample sizes lead to uncertainty in the relative effect estimates and may undermine the validity of the comparisons. However, the results are strongly in favour of D+T compared with TMZ, with the HR and OR estimates significantly favouring D+T for all outcomes.

All patients in TADPOLE had *BRAF* V600 mutation and there is conflicting evidence about whether this is a predictor of improved or worse outcomes for these patients, leading to uncertainty about the direction of bias this might introduce when comparing the two treatment groups.

Patients were also predominantly TMZ-naïve in the comparator studies, compared with a mixture of patients pre-treated and naïve to TMZ in the TADPOLE study. Receiving prior TMZ was considered an important negative prognostic factor by a clinical expert who was consulted for the project (28). Patients pre-treated with TMZ were deemed likely to have poorer prognosis than those who were TMZ-naïve, thus biasing the results in favour of TMZ for the all-patient analyses.

In addition, an unanchored MAIC assumes that the differences between absolute outcomes that would be observed in each trial are entirely explained by imbalances in prognostic variables and treatment effect modifiers, which may be too strong an assumption. Matching adjustments were limited to data reported in the comparator trials and that collected in TADPOLE.

In the absence of more robust comparative studies, the MAIC provides a directional indication of the relative benefit of D+T compared with TMZ, with D+T demonstrating significantly better OS, PFS and ORR compared with TMZ in both the all-patient population and TMZ-naïve subgroup. The unanchored MAIC approach is helpful, given data limitations for the treatments that prevented construction of network meta-analyses for the outcomes of interest.

B.2.10 Adverse reactions

Sections B.2.10.1–B.2.10.2 present an overview of safety data from the final analysis data cut of TADPOLE (28th April 2023) (39). Results from the primary analysis data cut (23rd August 2021) (40) are presented in Appendix N.

B.2.10.1 LGG cohort

B.2.10.1.1 Exposure to study treatment (Final analysis data cut)

The median duration of exposure to dabrafenib was 140.0 weeks (range: 2.7–218.6), and exposure to trametinib was 135.1 weeks (range: 2.7–218.6). A total of 89.0% of patients received D+T for 56 weeks or longer; 72.6% of patients received D+T for at least 112 weeks (Appendix F).

The median duration of exposure to carboplatin was 54.0 weeks (range: 12.0–70.3), and exposure to vincristine was 48.0 weeks (range: 12.0–70.1); 45.5% of patients received carboplatin and 42.4% of patients received vincristine for at least 56 weeks (Appendix F). Four patients did not initiate C+V treatment and were therefore excluded from the analysis. Of note, patients in the D+T arm continued to receive treatment until disease progression, while patients in the C+V arm received one course of induction (10 weeks of chemotherapy with 2 weeks of rest), followed by up to 8 cycles of maintenance chemotherapy (each maintenance cycle was 6 weeks).

In the crossover phase, the median duration of D+T exposure prior to the final analysis DCO date for both dabrafenib and trametinib was 122.6 weeks (range: 18.4–213.7 for dabrafenib, 19.0–213.7 for trametinib).

B.2.10.1.2 Overview of adverse events (Final analysis data cut)

Table 22 presents an overview of AEs that occurred in LGG cohort. The safety findings were consistent with the known safety profile of D+T in adult patients and of C+V, with no new safety signals identified. The median duration of follow-up was 39.0 months (range: 28.0–55.5), with a minimum follow-up from last randomised patient to final analysis DCO date.

In the LGG cohort, all patients in both arms experienced at least one AE. Grade ≥ 3 AEs were reported less frequently in the D+T arm compared with the C+V arm (53.4% vs 93.9%). The risk difference favoured D+T for Grade ≥ 3 AEs, treatment-related AEs, treatment-related serious adverse events (SAE), and AEs leading to discontinuation, compared with C+V. No on-treatment deaths were reported in either treatment arm (Table 28). A summary of AEs by system organ class (SOC) is presented in Appendix F.

Table 28: Overview of AEs, Safety set-LGG

	D+T N=73		C+V N=33		D+T vs C+V risk difference (95%CI)	
	All grades n (%)	Grade ≥3 n (%)	All grades n (%)	Grade ≥3 n (%)	All grades	Grade ≥3
AEs	73 (100.0)	39 (53.4)	33 (100.0)	31 (93.9)	NE (NE, NE)	-40.5 (-54.6, -26.5)
Treatment-related	68 (93.2)	23 (31.5)	32 (97.0)	29 (87.9)	-3.8 (-12.1, 4.4)	-56.4 (-71.8, -41.0)
SAEs	34 (46.6)	26 (35.6)	14 (42.4)	8 (24.2)	4.2 (-16.2, 24.5)	11.4 (-6.9, 29.7)
Treatment-related	11 (15.1)	7 (9.6)	9 (27.3)	5 (15.2)	-12.2 (-29.5, 5.1)	-5.6 (-19.5, 8.4)
Fatal SAEs	0 (0.0)	0 (0.0)	0 (0.0)	0 (0.0)	NE	NE
Treatment-related	0 (0.0)	0 (0.0)	0 (0.0)	0 (0.0)	NE	NE
AEs leading to discontinuation	4 (5.5)	3 (4.1)	8 (24.2)	3 (9.1)	-18.8 (-34.3, -3.2)	-5.0 (-15.8, 5.8)
Treatment-related	4 (5.5)	3 (4.1)	8 (24.2)	3 (9.1)	-18.8 (-34.3, -3.2)	-5.0 (-15.8, 5.8)
AEs leading to dose adjustment/interruption	61 (83.6)	33 (45.2)	26 (78.8)	19 (57.6)	4.8 (-11.6, 21.1)	-12.4 (-32.7, 8.0)
AEs requiring additional therapy	73 (100.0)	28 (38.4)	33 (100.0)	22 (66.7)	NE (NE, NE)	-28.3 (-47.9, -8.7)

Data cut: Final analysis data cut, 28th April 2023.

A patient with multiple severity grades for an AE is only counted under the maximum grade.

MedDRA version 24.0, CTCAE version 4.03.

Abbreviations: AE, adverse event; C, carboplatin; CI, confidence interval; CTCAE, Common Terminology Criteria for Adverse Events;

D, dabrafenib; LGG, low-grade glioma; MedDRA, Medical Dictionary for Regulatory Activities; NE, not estimable; SAE, serious adverse event; T, trametinib; V, vincristine.

B.2.10.1.3 Adverse events by preferred term (Final analysis data cut)

The most frequently reported AEs (≥30% in either arm) in the D+T vs C+V arm by preferred term (PT) are presented in Table 29. The most frequently reported AEs (difference of ≥30% between arms) by PT were pyrexia (+57.2%), anaemia (-41.4%), and neutrophil count decreased (-33.4%). Grade ≥3 AEs were reported less frequently in the D+T arm compared with the C+V arm (53.4% vs 93.9%). The most frequently reported Grade ≥3 AEs (≥30% in either group) in the D+T vs C+V arms were neutropenia (9.6% vs 30.3%), and neutrophil count decreased (5.5% vs 48.5%), respectively (Table 29). A summary of AEs by PT (occurring in at least 10% of patients in either arm) is presented in Appendix F.

Company evidence submission template for dabrafenib with trametinib for treating *BRAF* V600E mutation-positive glioma in children and young people aged 1 to 17 [ID5104]

© Novartis (2023). All rights reserved

Table 29: Adverse events (occurring in ≥30% of patients in either group) by PT, Safety set-LGG

	D+T N=73		C+V N=33		D+T vs C+V risk difference	
	All grades n (%)	Grade ≥3 n (%)	All grades n (%)	Grade ≥3 n (%)	All grades	Grade ≥3
Number of patients with at least one event	73 (100.0)	39 (53.4)	33 (100.0)	31 (93.9)	NE (NE, NE)	-40.5 (-54.6, -26.5)
Pyrexia	55 (75.3)	10 (13.7)	6 (18.2)	1 (3.0)	57.2 (40.7, 73.6)	10.7 (0.8, 20.5)
Headache	40 (54.8)	1 (1.4)	9 (27.3)	1 (3.0)	27.5 (8.5, 46.5)	-1.7 (-8.1, 4.8)
Diarrhoea	27 (37.0)	0 (0.0)	6 (18.2)	2 (6.1)	18.8 (1.6, 36.0)	-6.1 (-14.2, 2.1)
Vomiting	27 (37.0)	1 (1.4)	17 (51.5)	1 (3.0)	-14.5 (-34.9, 5.8)	-1.7 (-8.1, 4.8)
COVID-19	26 (35.6)	1 (1.4)	0 (0.0)	0 (0.0)	35.6 (24.6, 46.6)	1.4 (-1.3, 4.0)
Fatigue	25 (34.2)	0 (0.0)	10 (30.3)	0 (0.0)	3.9 (-15.1, 23.0)	NE (NE, NE)
Nausea	21 (28.8)	0 (0.0)	17 (51.5)	0 (0.0)	-22.7 (-42.7, -2.8)	NE (NE, NE)
Anaemia	14 (19.2)	0 (0.0)	20 (60.6)	8 (24.2)	-41.4 (-60.4, -22.5)	-24.2 (-38.9, -9.6)
Neutrophil count decreased	11 (15.1)	4 (5.5)	16 (48.5)	16 (48.5)	-33.4 (-52.3, -14.5)	-43.0 (-60.8, -25.2)
Constipation	10 (13.7)	0 (0.0)	12 (36.4)	0 (0.0)	-22.7 (-40.9, -4.5)	NE (NE, NE)
Neutropenia	10 (13.7)	7 (9.6)	10 (30.3)	10 (30.3)	-16.6 (-34.2, 0.9)	-20.7 (-37.8, -3.6)
WBC decreased	9 (12.3)	0 (0.0)	12 (36.4)	5 (15.2)	-24.0 (-42.1, -6.0)	-15.2 (-27.4, -2.9)
Platelet count decreased	4 (5.5)	0 (0.0)	10 (30.3)	3 (9.1)	-24.8 (-41.3, -8.3)	-9.1 (-18.9, 0.7)

Data cut: Final analysis data cut, 28th April 2023.

A patient with multiple severity grades for an AE is only counted under the maximum grade.

MedDRA version 24.0, CTCAE version 4.03.

Abbreviations: AE, adverse event; C, carboplatin; COVID-19, coronavirus disease 2019; CTCAE, Common Terminology Criteria for Adverse Events; D, dabrafenib; LGG, low-grade glioma; MedDRA, Medical Dictionary for Regulatory Activities; NE, not estimable; PT, preferred term; SAE, serious adverse event; T, trametinib; V, vincristine; vs, versus; WBC, white blood cell.

B.2.10.1.4 Treatment-related adverse events

The number of patients with AEs suspected to be related to treatment was similar in both treatment arms (93.2% vs 97.0%). Grade ≥3 AEs suspected to be treatment-related were reported less frequently in the D+T arm compared with the C+V arm (█% vs █%). The most frequently reported AEs suspected to be treatment-related (≥30% in either group) in the D+T vs C+V groups by PT were: pyrexia (█% vs █%), vomiting (█% vs █%), nausea (█% vs █%), neutrophil count decreased (█% vs █%), white blood cell (WBC) count decreased (█% vs █%), anaemia (█% vs █%), constipation (█% vs █%), neutropenia (█% vs █%), and platelet count decreased (█% vs █%), respectively (Table 30). A full overview of treatment-related AEs is presented in Appendix F.

Table 30: Adverse events suspected to be related to study drug (occurring in ≥30% of patients in either group) by PT, Safety set-LGG

	D+T N=73		C+V N=33		D+T vs C+V risk difference	
	All grades n (%)	Grade ≥3 n (%)	All grades n (%)	Grade ≥3 n (%)	All grades	Grade ≥3
Number of patients with at least one event	68 (93.2)	23 (31.5)	32 (97.0)	29 (87.9)	█	█
Pyrexia	█	█	█	█	█	█
Vomiting	█	█	█	█	█	█
Nausea	█	█	█	█	█	█
Neutrophil count decreased	█	█	█	█	█	█
WBC count decreased	█	█	█	█	█	█
Anaemia	█	█	█	█	█	█
Constipation	█	█	█	█	█	█
Neutropenia	█	█	█	█	█	█
Platelet count decreased	█	█	█	█	█	█

Data cut: Final analysis data cut, 28th April 2023.

A patient with multiple severity grades for an AE is only counted under the maximum grade.

MedDRA version 24.0, CTCAE version 4.03.

Abbreviations: AE, adverse event; ALT, alanine aminotransferase; C, carboplatin; CI, confidence interval; CTCAE, Common Terminology Criteria for Adverse Events; D, dabrafenib; LGG, low-grade glioma; MedDRA, Medical Dictionary for Regulatory Activities; NE, not estimable; PT, preferred term; SAE, serious adverse event; T, trametinib; V, vincristine; WBC, white blood cell.

Company evidence submission template for dabrafenib with trametinib for treating *BRAF* V600E mutation-positive glioma in children and young people aged 1 to 17 [ID5104]

© Novartis (2023). All rights reserved

B.2.10.1.5 Serious adverse events

The number of patients with SAEs was similar in both treatment arms (Table 31). The most frequently reported SAEs by PT were pyrexia (■■■■% vs ■■■■%), tonsillitis and vomiting (both ■■■■% vs ■■■■%). All other SAEs are presented in Appendix F.

Table 31: Serious AEs by preferred term, occurring in over 3% of patients, Safety set-LGG

	D+T N=73		C+V N=33		D+T vs C+V risk difference (95% CI)	
	All grades n (%)	Grade ≥3 n (%)	All grades n (%)	Grade ≥3 n (%)	All grades	Grade ≥3
Number of patients with at least one event	34 (46.6)	26 (35.6)	14 (42.4)	8 (24.2)	■■■■	■■■■
Pyrexia	■■■■	■■■■	■■■■	■■■■	■■■■	■■■■
Tonsillitis	■■■■	■■■■	■■■■	■■■■	■■■■	■■■■
Vomiting	■■■■	■■■■	■■■■	■■■■	■■■■	■■■■

Data cut: Final analysis data cut, 28th April 2023.

A patient with multiple severity grades for an AE is only counted under the maximum grade.

MedDRA version 24.0, CTCAE version 4.03.

Abbreviations: AE, adverse event; C, carboplatin; CI, confidence interval; CTCAE, Common Terminology Criteria for Adverse Events; D, dabrafenib; LGG, low-grade glioma; MedDRA, Medical Dictionary for Regulatory Activities; NE, not estimable; PT, preferred term; SAE, serious adverse event; T, trametinib; V, vincristine.

B.2.10.1.6 Treatment discontinuations

In total, ■■■■ patients (■■■■%) receiving D+T experienced an adverse event leading to treatment discontinuation, compared with ■■■■ patients (■■■■%) in the C+V arm (Table 32).

Table 32: Adverse events leading to discontinuation of study treatment by PT, Safety set-LGG

	D+T N=73		C+V N=33		D+T vs C+V risk difference (95% CI)	
	All grades n (%)	Grade ≥3 n (%)	All grades n (%)	Grade ≥3 n (%)	All grades	Grade ≥3
Number of patients with at least one event	4 (5.5)	3 (4.1)	8 (24.2)	3 (9.1)	████████	████████
Pyrexia	████████	████████	████████	████████	████████	████████
Chills	████████	████████	████████	████████	████████	████████
Fatigue	████████	████████	████████	████████	████████	████████
Headache	████████	████████	████████	████████	████████	████████
Weight increased	████████	████████	████████	████████	████████	████████
Dizziness	████████	████████	████████	████████	████████	████████
Eyelid ptosis	████████	████████	████████	████████	████████	████████
Hypersensitivity	████████	████████	████████	████████	████████	████████
Infusion-related reaction	████████	████████	████████	████████	████████	████████
Nausea	████████	████████	████████	████████	████████	████████
Neuropathy peripheral	████████	████████	████████	████████	████████	████████
Neutropenia	████████	████████	████████	████████	████████	████████
Peripheral motor neuropathy	████████	████████	████████	████████	████████	████████
Urticaria	████████	████████	████████	████████	████████	████████

Data cut: Final analysis data cut, 28th April 2023.

A patient with multiple severity grades for an AE is only counted under the maximum grade. MedDRA version 24.0, CTCAE version 4.03.

Abbreviations: AE, adverse event; C, carboplatin; CI, confidence interval; CTCAE, Common Terminology Criteria for Adverse Events; D, dabrafenib; LGG, low-grade glioma; MedDRA, Medical Dictionary for Regulatory Activities; NE, not estimable; PT, preferred term; T, trametinib; V, vincristine.

B.2.10.2 HGG cohort

B.2.10.2.1 Exposure to study treatment

The median duration of exposure to both dabrafenib and trametinib was 121.1 weeks (range: 1.3–213.4) at the time of the final analysis DCO, with 17 patients (41.5%) completing treatment. A total of 63.5% of patients received D+T for ≥56 weeks and 53.7% patients received D+T for at least 112 weeks (Appendix F).

B.2.10.2.2 Overview of adverse events

The safety findings were consistent with the known safety profile of D+T (in adult patients) and of C+V, with no new safety signals identified. The patient median duration of follow-up was 45.2 months (range: 31.9–61.2), with the minimum study follow-up from last patient's start of treatment to final analysis DCO date).

In the HGG cohort, at least one AE was reported in all patients. In total, 68.3% of patients experienced an SAE. Grade ≥3 AEs were reported in 73.2% of patients (Table 33). Six on-treatment deaths were reported, of which four were due to disease progression and two were secondary to other causes; one patient died due to encephalomyelitis and one due to increased intracranial pressure. One of the three patients who died due to disease progression also had a fatal AE (apnoea). A summary of AEs by SOC is presented in Appendix F.

Table 33: Overview of AEs, Safety set-HGG

	All patients N=41		
	All grades n (%)	Grade ≥3 n (%)	Grade 5 n (%)
AEs	41 (100.0)	30 (73.2)	3 (7.3)
Treatment-related	35 (85.4)	12 (29.3)	0 (0.0)
SAEs	28 (68.3)	24 (58.5)	3 (7.3)
Treatment-related	7 (17.1)	6 (14.6)	0 (0.0)
Fatal SAEs	3 (7.3)	3 (7.3)	3 (7.3)
Treatment-related	0 (0.0)	0 (0.0)	0 (0.0)
AEs leading to discontinuation	2 (4.9)	0 (0.0)	0 (0.0)
Treatment-related	1 (2.4)	0 (0.0)	0 (0.0)
AEs leading to dose adjustment/interruption	28 (68.3)	14 (34.1)	2 (4.9)
AEs requiring additional therapy	40 (97.6)	25 (61.0)	1 (2.4)

Data cut: Final analysis data cut, 28th April 2023.

A patient with multiple severity grades for an AE is only counted under the maximum grade. MedDRA version 24.0, CTCAE version 4.03.

Abbreviations: AE, adverse event; CTCAE, Common Terminology Criteria for Adverse Events; HGG, high-grade glioma; MedDRA, Medical Dictionary for Regulatory Activities; SAE, serious adverse event.

B.2.10.2.3 Adverse events by preferred term

The most frequently reported AEs (occurring in $\geq 15\%$ of patients) by PT in the HGG cohort were pyrexia (53.7%), headache (46.3%), dry skin (34.1%), vomiting (29.3%), and nausea (26.8%) (Table 34). A summary of all AEs by PT is presented in Appendix F.

Table 34: Adverse events (occurring in $\geq 15\%$ of patients) by PT, Safety set-HGG

	All patients N=41	
	All grades n (%)	Grade ≥ 3 n (%)
Number of patients with at least one event	41 (100.0)	30 (73.2)
Pyrexia	22 (53.7)	1 (2.4)
Headache	19 (46.3)	4 (9.8)
Dry skin	14 (34.1)	0
Vomiting	12 (29.3)	2 (4.9)
Nausea	11 (26.8)	0
Diarrhoea	10 (24.4)	1 (2.4)
Upper respiratory tract infection	10 (24.4)	0
Rash	9 (22.0)	1 (2.4)
Cough	7 (17.1)	0
Neutropenia	7 (17.1)	1 (2.4)

Data cut: Final analysis data cut, 28th April 2023.

A patient with multiple severity grades for an AE is only counted under the maximum grade. MedDRA version 24.0, CTCAE version 4.03.

Abbreviations: AE, adverse event; CTCAE, Common Terminology Criteria for Adverse Events; HGG, high-grade glioma; MedDRA, Medical Dictionary for Regulatory Activities; PT, preferred term.

B.2.10.2.4 Treatment-related adverse events

Adverse events suspected to be treatment-related were reported in 35 patients (85.4%), with 12 patients (29.3%) experiencing Grade ≥ 3 AEs potentially related to study treatment. The most frequently reported AEs ($\geq 10\%$) suspected to be treatment-related were pyrexia (█████%), dry skin (█████%), rash (█████%), neutropenia, and rash maculo-papular (both █████%) (Table 35).

Table 35: Adverse events suspected to be related to the study drug (occurring in $\geq 5\%$ of patients) by PT, Safety set-HGG

	All patients N=41	
	All grades n (%)	Grade ≥ 3 n (%)
Number of patients with at least one event	35 (85.4)	12 (29.3)
Pyrexia	█████	█████
Dry skin	█████	█████
Rash	█████	█████
Neutropenia	█████	█████
Rash maculo-papular	█████	█████

Appendices for dabrafenib with trametinib for treating BRAF V600E mutation-positive glioma in children and young people aged 1 to 17

© Novartis (2023). All rights reserved

	All patients N=41	
	All grades n (%)	Grade ≥3 n (%)
Acne	██████	██████
ALT increased	██████	██████
Dermatitis acneiform	██████	██████
Diarrhoea	██████	██████
Erythema nodosum	██████	██████
WBC decreased	██████	██████
AST increased	██████	██████
Eczema	██████	██████
Ejection fraction decreased	██████	██████
Erythema	██████	██████
Epistaxis	██████	██████
Headache	██████	██████
Nausea	██████	██████
Oedema peripheral	██████	██████
Vomiting	██████	██████
Weight increased	██████	██████

Data cut: Final analysis data cut, 28th April 2023.

A patient with multiple severity grades for an AE is only counted under the maximum grade. MedDRA version 24.0, CTCAE version 4.03.

Abbreviations: AE, adverse event; ALT, alanine aminotransferase; AST, aspartate aminotransferase; CTCAE, Common Terminology Criteria for Adverse Events; HGG, high-grade glioma; MedDRA, Medical Dictionary for Regulatory Activities; PT, preferred term; SAE, serious adverse event; WBC, white blood cell.

B.2.10.2.5 Serious adverse events

SAEs were reported in 28 patients (68.3%) of which 24 (58.5%) had Grade ≥3 SAEs. The most frequently reported SAEs (occurring in ≥3% of patients) were headache and pyrexia (████% each). Except for the SAEs of hydrocephalus, intracranial pressure increased, and seizure that were reported in █████ patients, all other SAEs were reported in █████ patient each (Table 36). An overview of all SAEs are presented in Appendix F.

Table 36: Serious adverse events by PT (occurring in ≥3% of patients), Safety set-HGG

	All patients N=41	
	All grades n (%)	Grade ≥3 n (%)
Number of patients with at least one event	28 (68.3)	24 (58.5)
Headache	██████	██████
Pyrexia	██████	██████
Hydrocephalus	██████	██████
Intracranial pressure increased	██████	██████

	All patients N=41	
	All grades n (%)	Grade ≥3 n (%)
Seizure	██████	██████

Data cut: Final analysis data cut, 28th April 2023.

A patient with multiple severity grades for an AE is only counted under the maximum grade. MedDRA version 24.0, CTCAE version 4.03.

Abbreviations: AE, adverse event; CTCAE, Common Terminology Criteria for Adverse Events; HGG, high-grade glioma; MedDRA, Medical Dictionary for Regulatory Activities; PT, preferred term.

B.2.10.2.6 Treatment discontinuations

██████ patients (██████%) discontinued study treatment due to AEs of rash (Grade 1 in ██████ patient and unknown grade in the ██████████).

B.2.11 Ongoing studies

An overview of ongoing studies of dabrafenib with trametinib in paediatric patients with gliomas is provided in Table 37.

Table 37: Ongoing studies of dabrafenib with trametinib in paediatric gliomas

Study number	Study objective	Study design	Estimated completion
NCT04201457	To study the side effects, best dose and efficacy of adding hydroxychloroquine to dabrafenib and/or trametinib in children with <i>BRAFm</i> LGGs or HGGs previously treated with similar drugs, that did not respond completely or recurrent tumours after receiving a similar agent	Open-label, multicentre, non-randomised, Phase 1/2 trial	June 2027
NCT03919071	To study how well the combination of dabrafenib and trametinib works after radiation therapy in children and young adults with HGG and a <i>BRAF</i> V600 mutation	Open-label, multicentre, single-arm, Phase 2 trial	September 2027
NCT03975829	A roll-over study to assess long-term effect in paediatric patients treated with dabrafenib and/or trametinib	Open-label, multicentre, rollover Phase 4 study. Patients from TADPOLE, Study NCT01677741, or Study NCT02124772 were eligible for inclusion	July 2026

Abbreviations: BRAF, v-raf murine sarcoma viral oncogene homolog B; BRAFm, v-raf murine sarcoma viral oncogene homolog B mutation positive; HGG, high-grade glioma; LGG, low-grade glioma.

B.2.12 Interpretation of clinical effectiveness and safety evidence

Gliomas are the most common CNS tumours in children, with LGG reported as the most prevalent childhood brain tumour (76, 77). In paediatric patients with LGG, the presence of a *BRAF* V600E mutation is associated with an increased risk of transformation to HGG compared with wild-type LGG (17), and is also associated with poor outcomes post-radiation and conventional chemotherapy. Paediatric patients with *BRAF* mutation-positive LGG have significantly lower 10-year PFS compared with those with wild-type LGG (27% vs 60.2%, $p < 0.001$), highlighting the need for a different therapeutic approach to treat *BRAF* mutation-positive tumours from that used for wild-type tumours (20). Furthermore, for patients with relapsed/refractory LGG, temozolomide is the only chemotherapy with an EU marketing authorisation for children and young adults in the recurrent disease setting (30). However, patients receiving TMZ monotherapy or TMZ-based combinations in the recurrent setting have poor response rates, ranging from 0–25% (62, 64-67, 71) (Appendix D).

Although rare, HGGs are the leading cause of cancer-related deaths in children (60), with a median survival of only nine to 18 months (61). While new therapies have recently been developed for the treatment of HGG, they have yet to provide a notable improvement in PFS or OS (11).

B.2.12.1 TADPOLE and Study NCT02124772

The efficacy and safety of dabrafenib in combination with trametinib was assessed in TADPOLE, a Phase 2, open-label, multicentre, global study in children and adolescent patients with *BRAF* V600E mutation-positive LGG or relapsed or refractory HGG. Clinical experts consider that the disease characteristics of patients recruited in TADPOLE are in line with the general UK population of patients with paediatric LGG and HGG (28, 29); the majority of LGG tumours were of astrocytoma histology, while the majority of HGG tumours were glioblastoma multiforme, or of astrocytoma histology. In total, five patients were treated in three UK-based centres.

The Phase 1/2 study (NCT02124772) also supports the clinical evidence base of this submission with regard to paediatric patients with relapsed/refractory *BRAF* V600E mutation-positive LGG (69); a summary of which is presented as supplementary data in Appendix O.

B.2.12.2 Efficacy within the LGG cohort

In the LGG cohort, treatment with D+T led to a clinically meaningful ORR per independent review compared with C+V (ORR: 54.8% [95% CI: 42.7, 66.5] vs 16.2% [95% CI: 6.2, 32.0], respectively), with an OR of 6.26 (95% CI: 2.3, 16.8). The ORR observed with C+V was consistent with historical expectations for this molecularly-defined population (10% CR+PR by RANO criteria) (46).

Results of the secondary efficacy endpoints were supportive of the primary endpoint. Results of ORR per Investigator assessment were consistent with those observed per

independent review, with an ORR of 58.9% (95% CI: 46.8, 70.3) in the D+T arm compared with 18.9% (95% CI: 8.0, 35.2) in the C+V arm, and an OR of 6.14 (95% CI: 2.4, 15.8). The median PFS per independent assessment was longer in the D+T arm compared with the C+V arm (24.9 months vs 7.2 months), with an estimated 64% risk reduction in progression/death (HR 0.36; 95% CI: 0.22, 0.59). The investigator assessment also demonstrated a clinically meaningful benefit in PFS with D+T vs C+V, with an estimated 54% risk reduction in progression/death (HR: 0.46; 95% CI: 0.24, 0.88). Data for OS are currently very immature, with no deaths in the D+T arm and one death in the C+V arm. With regard to HRQoL, patients showed a trend towards improvement for general health and fatigue favouring D+T over C+V.

In TADPOLE, patients with LGG who were randomised to the C+V arm were allowed to cross over to receive D+T only after centrally confirmed and RANO-defined disease progression. Twelve patients in the C+V arm met these criteria, and each crossed over to the D+T arm. Overall response rate per independent review was 41.7% (95% CI: 15.2, 72.3; n=5/12) in the crossover arm; all five responses were PR. The CBR was 75.0% (95% CI: 42.8, 94.5; n=9/12). The treatment of patients with progressive disease with D+T indicates the combination therapy may also be used in the treatment of relapsed/refractory paediatric LGG.

In line with TADPOLE, patients treated with D+T in the Phase 1/2 study (NCT02124772) experienced a clinically meaningful response (ORR per independent assessment: 25% [95% CI: 12.1, 42.2]). Responses were durable, with a median DOR of 33.6 months (95% CI: 11.2, NE). The median PFS per independent assessment was 36.9 months (95% CI: 36.0, NE), with 80% of patients remaining progression-free at 24 months (69). The results from the Phase 1/2 study demonstrate that D+T combination therapy may address the unmet need in treating patients with relapsed/refractory paediatric LGG.

B.2.12.3 Efficacy within the HGG cohort

In the HGG cohort, the anti-tumour activity of D+T, as measured by the centrally-assessed ORR using RANO criteria, was demonstrated with an ORR of 56.1% (95% CI: 39.7, 71.5), including a CR of 34.1%. The lower bound of the 95% CI for D+T ORR was greater than the 20% rate as pre-specified in the study protocol, representing a clinically meaningful benefit for patients with HGG. Treatment with D+T was associated with early and durable response. The median DOR was 27.4 months (95% CI: 9.2, NE). Twelve patients continued to be in response at the time of the final analysis. Multiple secondary and supportive analyses of DOR were pre-planned, and each was consistent with the DOR results. Median PFS per independent review was 9.0 months (95% CI: 5.3, 20.1).

As of the final analysis DCO date, OS data were immature. A total of 24/41 patients were censored (i.e. did not have a survival event) and were ongoing at the time of the DCO date. The estimated survival rates at 12 and 24 months were 77.0% (95% CI: 60.4, 87.3) and 61.0% (95% CI: 43.8, 74.4), respectively.

In the absence of a head-to-head trial comparing D+T with other treatment comparators, an SLR was conducted to identify clinical evidence for treatments in patients with glioma harbouring a *BRAF* V600 mutation. Searches were subsequently broadened to 'molecularly

unselected patients' (e.g. irrespective of mutation) to inform the evidence base for an indirect comparison, owing to an absence of published data in patients with a *BRAF* V600 mutation. While the naïve comparison between studies needs to be interpreted with caution, the TADPOLE study shows encouraging results compared with outcomes in studies identified in the SLR in molecularly unselected patients with poor response rates, ranging between 0–25%, median PFS ranging between 1–3 months, and median OS ranging between 3–7 months.

B.2.12.4 Safety

Overall, D+T was well tolerated, and reported treatment-emergent AEs were generally consistent with what is anticipated with D+T in an adult population, and with C+V treatment. Five on-treatment deaths were reported, of which [REDACTED] were due to disease progression and [REDACTED] were secondary to other causes.

B.3 Cost effectiveness

Summary of the cost-effectiveness analysis

A de novo cost-effectiveness model was developed to assess the cost-effectiveness of D+T compared with established clinical management (chemotherapy and best supportive care) in England and Wales. The economic evaluation is based on the pivotal Phase 2 randomised controlled trial, TADPOLE, which recruited paediatric patients with *BRAF* V600E mutation-positive glioma. An individual-based state transition model was used, with health states based on progression phases. This approach was selected in order to accommodate duration of treatment, dosage that was age/weight dependent, reducing chance of progression as patients reach adulthood, and to avoid the need for tunnel states.

The economic analysis was conducted in line with the NICE reference case (78). Utility values were derived from EuroQoL five-dimensions (EQ-5D) data in adults. External data in molecularly unselected patients were used in the absence of data for patients with *BRAF* V600E mutations. Healthcare resource use and subsequent treatments were obtained from the literature, supplemented by clinical opinion, where appropriate.

Cost-effectiveness results

Owing to the severity of the disease, paediatric patients with glioma experienced a substantial quality-adjusted life-year (QALY) shortfall compared with the general population (Section B.3.6), and therefore D+T in this indication met the criteria for decision modifiers for severity of disease. The base-case analysis showed that D+T is a cost-effective option for the treatment of children and young adults with *BRAF* V600E mutation-positive glioma, with an incremental cost per QALY gained of (after application of the disease severity modifiers):

- £25,918/QALY in paediatric patients with LGG
- £28,624 in paediatric patients with HGG previously treated with temozolomide
- £29,072 in paediatric patients with HGG not previously treated with temozolomide

Probabilistic sensitivity analyses and deterministic sensitivity analyses were conducted, demonstrating that the cost-effectiveness results were robust in most scenario analyses. The key drivers and source of uncertainty were the discount rates for benefits, the duration of treatment, the treatment effect, and utility values.

Summary

Glioma is a rare disease associated with a poor prognosis, with no other reimbursed treatments in children and young adults. There is a high unmet need for a well-tolerated and effective therapy to reduce disease burden, delay progression, improve survival rates, and improve HRQoL. In addition to providing a cost-effective option to the NHS, treatment with dabrafenib and trametinib allows patients to be managed away from a hospital setting, and so may help alleviate NHS capacity issues in terms of IV administration and reduce the burden of AEs compared with chemotherapy.

B.3.1 Published cost-effectiveness studies

An SLR was conducted in July 2023 to identify cost-effectiveness studies relevant to the decision problem from the published literature. A complete description of the search strategies is presented in Appendix G.

B.3.1.1 Description of identified studies

The SLR did not identify any publications that were eligible for inclusion. A Preferred Reporting Items for Systematic Reviews and Meta-Analyses (PRISMA) diagram showing the overall flow of studies across the review is presented in Appendix G, together with a complete list of studies excluded after the full-text review stage.

B.3.2 Economic analysis

A de novo economic model was developed to inform this NICE submission. The objective of this economic analysis is to assess the cost-effectiveness of D+T compared with established SoC in paediatric patients with *BRAF* V600E mutation-positive LGG or relapsed or refractory HGG, otherwise referred to as the LGG and HGG cohorts, respectively.

In line with the NICE reference case (78), the analysis is conducted from the perspective of the NHS and Personal Social Services (PSS) and exclusively includes direct medical costs over a lifetime horizon.

B.3.2.1 Patient population

The population covered in this economic evaluation are paediatric patients with *BRAF* V600E mutation-positive LGG who require systemic treatment, or paediatric patients with relapsed/refractory *BRAF* V600E mutation-positive HGG. This is in line with the patient population described in the decision problem and the final scope issued by NICE (26), as well as the population covered by the anticipated marketing authorisation for D+T (33). Separate analyses are presented for the LGG and HGG cohorts, owing to the differences in biology and comparators. While no age reference is included in the NICE final scope (26), patients from TADPOLE (40) were aged less than 18 years at entry, in line with the anticipated marketing authorisation for D+T (33).

The economic evaluation was conducted in accordance with the trial population from the TADPOLE study (39), and therefore for the LGG cohort focuses on *BRAF* V600E mutant LGG with progressive disease following surgical excision, or non-surgical candidates with necessity to begin first systemic treatment. This is because TADPOLE represents the primary source of clinical evidence and most LGG patients with a *BRAF* V600E mutation identified at the time of their initial treatment would be offered a targeted treatment. However, previously treated patients with *BRAF* V600E mutant LGG, where D+T was not available at the time of their initial treatment, may also benefit from D+T as demonstrated by clinical evidence from the Phase 1/2 dose-finding expansion study. While evidence is less robust to conduct an economic evaluation, the previously treated patient population is expected to form a small (but clinically important) minority of patients eligible to receive D+T and is expected to diminish over time as the knowledge of mutation status is known at the

Dabrafenib with trametinib for treating *BRAF* V600E mutation-positive glioma in children and young people aged 1 to 17

time of first treatment decision and D+T becomes available. Previously treated patients have poor response with current chemotherapies (79, 80), and there is a large unmet need for these patients. Consequently, we urge the committee to exercise some flexibility in their decision making as recognised in the NICE method guide for rare conditions in young population and consider the economic case presented for their decision making to inform recommendation in both previously treated and untreated patients with LGG, in line with NICE final scope and marketing authorisation (26).

B.3.2.2 Model structure

The *de novo* economic model was developed in Microsoft® Excel (and uses visual basic application; for transparency, calculations were completed in Excel where possible, with outputs exported onto VB) and reflects the natural history and clinical pathway for paediatric patients with *BRAF* V600E mutation-positive glioma in England and Wales (28, 29). The conceptual model was developed following a systematic literature review, assessment of the data available, and discussions with two UK paediatric oncologists specialised in the treatment and management of glioma (28, 29). Due to the rarity of the condition and mutation, clinical experts were selected based on their experience in the management of paediatric patients with glioma and/or their experience with D+T. The UK clinical experts provided clinical input and opinion on the following topics:

- The natural history and clinical pathway for paediatric patients with *BRAF* V600E mutation-positive glioma
- Description of the current SoC
- Key benefits (and adverse reactions) expected from the use of D+T for the treatment of paediatric patients with glioma and SoC
- Expected use of D+T in clinical practice
- Plausibility of the survival extrapolations.

B.3.2.3 Model schematic

A simplified schematic of the model structure is presented in Figure 18. Similar structures were used for the LGG and HGG analyses, with differences described in Section B.3.2.4. The economic evaluation uses an individual-based state-transition model (STM), whereby simulated patients move through a series of health states (e.g. transitions between health states were explicitly modelled) with overall survival (OS) estimated indirectly.

Figure 18: Simplified model structure schematic

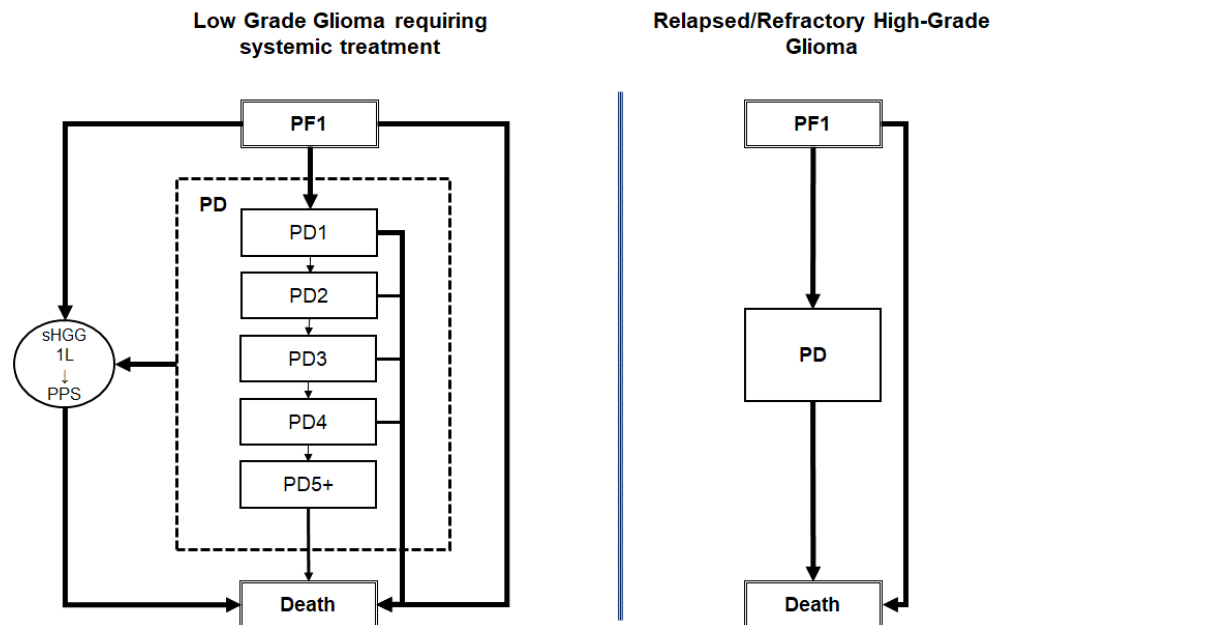

Abbreviations: PD, progressive disease; PF, progression-free; sHGG, secondary high-grade (malignant) glioma; 1L, first-line.

B.3.2.4 Health states and movement between health states

Both the LGG and HGG models were composed of three common, mutually exclusive health states: 1) progression-free following first treatment (PF1), 2) progressive disease (PD), and 3) death. The model structure did not allow for improvements in health state, reflecting the progressive nature of glioma and therefore the health states typically considered when modelling anti-cancer therapies. In addition to the three health states that are common to both populations (PF, PD, death), paediatric patients with LGG can transform to malignant glioma (e.g. secondary HGG [sHGG]), and therefore an additional health state (sHGG; subdivided into first-line and post-progression survival [PPS]) was considered for this cohort. Movements between health states are described below.

Progression-free following first treatment (PF1): Individuals entered the model in the 'PF1' health state, where they received either D+T or SoC:

- **For the LGG cohort**, patients in the PF1 health state were assumed to be progression-free at the point of entry and could either (a) remain in this health state in the absence of RANO progression, malignant transformation, or death, (b) move to the 'progressed disease' health state, (c) transform to malignant glioma, or (d) die.
- **For the HGG cohort (for the temozolomide [TMZ] comparison only)**, patients in the PF1 health state were assumed to be progression-free at the point of entry and could either (a) remain in this health state in the absence of RANO progression or death, (b) move to the 'progressed disease' health state (palliative care), or (c) die. For the comparison against BSC (previously treated with TMZ), patients enter the model directly in the PD health state (therefore assuming no PFS) as the aim of treatment is to treat symptoms, not the tumour and therefore patients are by definition in a progressive state.

The economic model considered both the on- and off-treatment periods.

Dabrafenib with trametinib for treating *BRAF* V600E mutation-positive glioma in children and young people aged 1 to 17

Progressed-disease health state: This represents the time from cessation of first therapy due to RANO progression to death or malignant transformation (for the LGG analysis).

- **PD for LGG:** For the LGG analysis, patients could either (a) remain in this health state (and cycle through a series of sub-health states representing different progression events/lines of treatment), (b) transform to malignant glioma, or (c) die. The '*progressive disease*' health state was divided into five sub-health states in the base case, representing different progression events to capture the impact of subsequent progressions on costs and QoL. These were considered sub-health states, as the transition to death was informed by the progression on first treatment (Section B.3.3.4.1). Likewise, simplifying assumptions were made due to the complexity of the pathway and data available. For example, while the cost for subsequent treatments following progression reflect the range and distribution of treatments (Section B.3.5.2.2) that is expected to be given (e.g. surgery, radiotherapy, chemotherapy, no treatment), in the economic model, the rate of subsequent progression was solely based on the progression of patients treated with chemotherapy (Section B.3.3.5), despite patients in clinical practice being able to receive different treatment modalities (e.g. surgery, radiotherapy, chemotherapy), or no treatment. This simplification was necessary, as the outcomes for patients who receive no further treatment following progression is unknown. In clinical practice, patients may also receive concurrent treatments. A scenario analysis was conducted around this structural assumption, excluding the impact of subsequent progression (Section B.3.10.3 and Appendix Q); e.g. the LGG model becomes a four-state model (PFS, PD, sHGG, and death).
- **PD for HGG:** For the HGG analysis, patients remain in this health state (assumed to be best supportive care [BSC]/palliative care) until death. For the comparison against BSC, patients in the comparator arm enter this health state directly in the absence of active treatment to treat the tumour. In this health state, treatment focuses on treating the symptoms and no longer the tumour.

Malignant transformation/secondary HGG: patients with LGG who transform to malignant glioma remain in this health state until death. This health state was sub-divided onto two health states (1) first-line treatment following malignant transformation, and (2) progressed disease (palliative care).

Death state: absorbing health state.

B.3.2.5 Model characteristics and justification

There are two key characteristics of the cost-effectiveness model:

- A state-transition approach was employed in order to 1) use external data to address the immaturity of the OS in the TADPOLE trial due to the indolent nature of LGG and time to death dependent on timing of progression, 2) reduce some of the potential biases in comparing OS from different studies for HGG due to potential differences in salvage treatments given post-progression and population recruited, and 3) model the worsening in QoL for patients with HGG at the end of life. A partitioned survival model (PSM) was considered inappropriate for the LGG cohort, as any long-term extrapolation to the observed Kaplan-Meier (KM) for OS could be considered arbitrary. A PSM, where OS and PFS are extrapolated, was initially considered for the HGG

analysis, however, following assessment of the data, a state-transition approach was preferred for 1) consistency with the LGG model (transparency and ease of review), 2) to allow the use of the same post-progression survival to reduce any potential biases in OS estimation due to the comparison of different studies, conducted in different population (*BRAF* V600E vs molecularly unselected patients), and possible differences in salvage regimens given post-progression that may ultimately affect OS, 3) model the progressive worsening in QoL when the aim of treatment focuses on treating the symptoms and no longer the tumour (e.g. BSC), and 4) mitigating some of challenges when including the correlation between PFS and direct OS within the individual based-approach.

- In contrast to many NICE submissions for oncology treatments, the model is individual patient-based and uses a time to event approach; thus, there were no time cycles. This approach was selected over a more traditional cohort approach in order to 1) extrapolate the dosage for D+T beyond the trial duration, as this is based on age/weight, 2) reflect the license for D+T that is restricted to patients aged 1 to 17 years old and thus the likelihood of discontinuation when patients reach adulthood, 3) the low risk of progression when patients reach adulthood, 4) incorporate the expected discontinuation of D+T in UK clinical practice in the absence of progression to avoid unnecessary treatment to reflect clinical feedback (28, 29), and 5) facilitate the modelling of the progressive worsening in HRQoL for paediatric patients with HGG on BSC/palliative care (although this would have been possible within a cohort approach). It should be acknowledged that while some of these elements could be implemented in a cohort model, compared with the cohort approach, the individual-based approach is also more flexible and avoids the use of tunnel states which can be convoluted and time consuming to implement notably given the long-time horizon in LGG. It should however be highlighted, that while an individual based approach was used, the model is not a 'true' patient-level model in the sense that many of the functions are programmed to estimate the average, rather than the heterogeneity between individuals. For simplicity and to speed up calculation, time is rounded to the nearest week (with the minimum sampled time possible being a week).

B.3.2.6 Model logic

The model's logic is summarised briefly in this section for transparency and completeness. The model simulated the life histories of a sufficiently large sample of paediatric patients with glioma (n=2,000; selected following a trade-off between model run time, notably for the probabilistic sensitivity analysis [PSA], and model convergence).

The simulation of the patient event histories used the Monte-Carlo sampling approach. This means that each uncertain event can occur randomly, but overall, the events conform to a pattern that is specified by the evidence available. For each simulated individual, the baseline characteristics in terms of age and gender were determined (Section B.3.3.1). Time-to-event was then sampled/estimated (using random numbers) from parametric distributions (Sections B.3.3.2, B.3.3.4, B.3.3.6, B.3.3.7, and B.3.3.9) to determine which event comes first, with the key events being 1) RANO progression (e.g. not progression due to malignant transformation), 2) malignant transformation (LGG analysis), and 3) death (glioma-related death, malignant death or non-glioma related). The event which occurred first in the model was the event with the lowest time-to-event. The occurrence of certain Dabrafenib with trametinib for treating *BRAF* V600E mutation-positive glioma in children and young people aged 1 to 17

events would therefore restrict other events from happening. For instance, non-glioma related death would end the simulation for a patient before progression could occur.

Figure 19 presents a simplified hypothetical example. In this example, based on the time-to-event generated, Patient 1 would experience RANO progression and subsequently die from glioma-related cause, while Patient 2 would experience RANO progression but die from non-glioma related causes. In contrast, Patient 3 would experience malignant transformation and subsequently die from it.

Figure 19: Hypothetical patients



Abbreviations: RANO, response-assessment for neuro-oncology.

B.3.2.7 Features of the economic analysis

The key features of the de novo analysis are summarised in Table 38. The model estimated the cost per QALY in line with the NICE methods guide (78). As the model uses an individual-based approach, and time was sampled (rounded to ‘a week’), no cycle length was required. The decision model employs a lifetime patient horizon, and uses an NHS and PSS perspective, as recommended by the NICE methods guide (78). A patient lifetime horizon was used to reflect the chronic nature of the disease and to capture all the relevant costs and benefits associated with the introduction of D+T in England and Wales. The decision model uses a discount rate of 3.5% per annum for both costs and benefits in the base case, as recommended in the NICE methods guide (78). Alternative discount rates were explored in sensitivity analyses (Section B.3.10.3). No half-cycle correction was required due to the individual-based approach.

Table 38: Features of the economic analysis

Factor	Current appraisal	
	Chosen values	Justification
Cycle Length	No cycle length	Individual-based approach. Time was sampled directly
Perspective	NHS/PSS	NICE reference case (78)
Time horizon	Lifetime (100 years)	Sufficient to capture all meaningful differences in technologies compared (78)
Discounting	3.5%	NICE reference case (78)

Factor	Current appraisal	
	Chosen values	Justification
Model type	State-transition individual-based model	An STM was chosen to incorporate external evidence to estimate OS. An individual-based approach was chosen to reflect the license for D+T, applying treatment continuation rules that reflect practice and to account for the progressive worsening in HRQoL for patients on BSC/palliative care
Treatment waning effect	No treatment effect was applied beyond the KM cut-off point selected	No treatment effect was assumed when treatment is stopped
Source of utilities	Derived from EQ-5D data from Drewes 2018 (81), Vera 2023 (82) and Hernandez 2023 (83)	NICE reference case (78)
Source of costs	NHS reference costs 2021/2022 (84), PSSRU 2022 (85), BNF (86), eMIT (87)	The sources of cost data are as per the NICE methods guide (78)

Abbreviations: BSC, best supportive care; BNF, British National Formulary; eMIT, electronic market information tool; EQ-5D, EuroQol five-dimensions; HR, hazard ratio; HRQoL, health-related quality of life; NHS, national health service; NICE, National Institute for Health and Care Excellence; PSS, Personal Social Services; PSSRU, Personal Social Services Research Unit; QALY, quality-adjusted life year; OS, overall survival; STM, state-transition model.

B.3.2.8 Intervention technology and comparators

B.3.2.8.1 Intervention: D+T

The economic analysis utilised evidence from the TADPOLE study (39), in which D+T was prescribed based on age and weight with:

- Dabrafenib 5.25 mg/kg/day divided into two equal oral doses per day for those under 12 years of age, and 4.5 mg/kg/day divided into two equal doses per day for those 12 years and above. Doses are not to exceed adult dose of 150 mg twice daily.
- Trametinib 0.032 mg/kg/day as a single oral dose for those under 6 years of age, and 0.025 mg/kg/day for those 6 years and above. Doses are not to exceed adult dose of 2 mg once daily.

A simplified dosing schedule, based on weight only, is recommended in the licence. The base case utilises the dosage received in the TADPOLE trial to align cost and efficacy. A scenario analysis was conducted where D+T is dosed based on weight only in accordance with the licence (Section B.3.10.3 and Appendix Q). The impact on the cost-effectiveness results was modest.

In TADPOLE, patients receiving D+T were treated until progression. The final TADPOLE analysis (DCO: 28th April 2023) was conducted when all patients were followed up for survival for at least 2 years from the last patient recruited (except in case of consent withdrawal, death, loss of follow up or study discontinuation). The draft SmPC states that treatment with D+T should continue until disease progression or until the development of unacceptable toxicity (33). The SmPC further states that “*there are limited data in patients* Dabrafenib with trametinib for treating *BRAF* V600E mutation-positive glioma in children and young people aged 1 to 17

older than 18 years of age with glioma, therefore continued treatment into adulthood should be based on benefits and risks to the individual patient as assessed by the physician”.

LGG: Clinical experts indicated that current chemotherapies are given for less than 2 years, and this is likely attributable to the cumulative toxicities with prolonged treatment and reducing risk of progression over time (28, 29). Similar to current chemotherapies, both clinical experts independently indicated that treatment with D+T would not be continued indefinitely in paediatric patients with LGG in clinical practice owing to the indolent nature of the condition, the reducing hazard of progression with time and age, and the benefit-risk ratio to treat patients (cumulative toxicities for no obvious clinical benefit) (28, 29). Both clinical experts independently stated that stopping D+T after approximately 2 years in the absence of progression is in line with current treatment protocols for chemotherapy, and an option to retreat at progression would reflect their preferred clinical strategy to avoid keeping patients on treatment unnecessarily, but also save costs to the NHS. However, one clinical expert acknowledged that a re-treatment strategy would not align with current funding arrangements. This view was echoed during the NICE scoping workshop.

Both clinical experts consulted independently considered that in absence of progression, D+T treatment would likely be stopped after 2 year up to a maximum of 5 years for LGG, depending on patient age and preference and clinical scenario (28, 29). Consequently, in line with clinical feedback, the economic analysis incorporated an informal stopping rule at 3.5 years for LGG (28, 29) to reflect the expected treatment duration in clinical practice. Nevertheless, in the base case, the KM was used up to Week 193 (≈ 3.7 years). Therefore, in the base case, a maximum treatment duration of 193 weeks was used to align with the KM cut off point selected. The duration of treatment however remains uncertain. Therefore, scenario analyses were conducted, varying the maximum treatment duration between 2 and 6 years (Section B.3.10.3 and Appendix Q). An option was also included in the model for patients to stop treatment once they reached adulthood, as implied by the licence, due to lack of data in patients aged over 18 years. The base-case analysis assumed a maximum treatment age of 19 years. Scenario analyses were conducted varying the age at which patient stopped treatment between 18 years to 22 years (Section B.3.10.3 and Appendix Q).

HGG: In contrast, for HGG patients, clinical experts highlighted that the condition is aggressive and associated with a very poor prognosis (28, 29). Clinical experts further noted that there is a lack of effective or alternative treatment options following progression. Therefore, clinical experts indicated that for paediatric patients with HGG, they would be more reluctant to stop treatment to prevent progression, and therefore are likely to continue until progression occurs (28, 29). Nevertheless, clinical experts acknowledge that in a minority of patients (notably those who have a good response and who maintained their response), treatment could be stopped. The base-case economic analysis assumed an informal stopping rule at 12.5 years, to reflect that long-term survivors may stop treatment in the absence of progression after a significant amount of time on treatment. Scenario analyses were conducted varying maximum treatment duration between 5 years to lifetime (Section B.3.10.3 and Appendix Q).

B.3.2.8.2 Comparators

B.3.2.8.2.1 LGG: Carboplatin plus vincristine (C+V) - Chemotherapy

In the TADPOLE study (39), C+V was administered according to the American schedule (COGA9952 protocol (88)); e.g. administered as one course of induction (10 weeks of chemotherapy [175 mg/m² carboplatin plus 1.5 mg/m² vincristine) with 2 weeks of rest, followed by 8 cycles (6 weeks [4 weeks on, 2 weeks off]) of maintenance chemotherapy.

Clinical experts indicated that in England, the European schedule (Table 39) as per the SIOP-LGG-2004 protocol (57) is used, as outlined in the Children's Cancer and Leukaemia group (CCLG) guidelines for the diagnosis and management of paediatric and adolescent Low-Grade Glioma (27). Clinical experts independently confirmed from their own experience that despite differences in schedule, both are interchangeable and are considered equivalent in terms of efficacy and safety (28, 29, 57, 88). The assumption of equivalence is further supported by published evidence. In molecularly unselected (e.g. BRAF mutation is not known) paediatric patients with LGG, the overall response rate (ORR) at 6 months was 29% for C+V using the SIOP-LGG-2004 protocol (57) (European schedule) and 35% using the COGA9952 protocol (88) (American schedule). The 5-year PFS/event-free survival (EFS) was 46.1% (±3.5%) and 39% (±4.0), respectively.

Table 39: European schedule (SIOP-LGG-2004 protocol (89)) for vincristine & carboplatin (Reproduction of Figure 3 in CCLG guidelines) assumed in the economic model

Induction: Week 1–24														
I			I							I	I	I	I	Carboplatin 550 mg/m ² (d1/week) over 1 hr [†]
I	I	I	I	I	I	I	I	I	I	I	I	I	I	Vincristine 1.5 mg/m ² (max 2 mg) (d1/week) [†]
1	2	3	4	5	6	7	8	9	10	13	17	21		
Consolidation: 6-week cycles starting Week 25, 31, 37, 43, 49, 55, 61, 67, 73, 79														
I														Carboplatin 550 mg/m ² (d1/week) over 1 hr [†]
I	I	I												Vincristine 1.5 mg/m ² (max 2 mg) (d1/week) [†]
1	2	3	4	5	6									

Source: CCLG (27).

Note: This table indicates the weeks during which chemotherapy was administered.

[†]Unless dose modifications.

Abbreviations: d1, day 1; hr, hour; max, maximum; mg, milligram.

Due to similar efficacy that is expected and to reflect costs incurred within the NHS, in line with the NICE method guide and clinical feedback, the European schedule for C+V (Table

39) using the SIOP-LGG-2004 protocol (57) as described in the CCLG guidelines (27) is assumed in the economic model.

B.3.2.8.2.2 HGG

Clinical experts indicated that for paediatric patients with HGG that are relapsed/refractory, options are very limited and often palliative. Clinical experts indicated that paediatric patients with HGG tend to receive a combination of focal radiotherapy plus TMZ in first-line (sometimes followed by lomustine [CCNU]) and that there are no effective and accepted SoC following relapse or recurrence on TMZ. Temozolomide is also the only chemotherapy with a UK marketing authorisation for children and young adults in the recurrent disease setting (90). For paediatric patients with HGG, two analyses are therefore presented:

D+T vs TMZ (chemotherapy) in patients not previously treated with TMZ

Clinical experts consulted indicated that in patients who did not receive TMZ up-front (although this is rare nowadays), TMZ is the most relevant comparator. In the economic analysis, TMZ was assumed to be administered once a day (for 5 days of a 28-day cycle) until progression at a daily dose of 200 mg/m², as per the dosing reported in Verschuur et al (2004) from which efficacy data were primarily obtained from (Section B.2.9) (66).

D+T vs best supportive care (BSC) in patients previously treated with TMZ

In patients who receive TMZ up-front who relapse or become refractory, TMZ is not a relevant comparator. Clinical experts indicated that for those patients, BSC/palliative care is the most relevant comparator, as chemotherapies tend to be ineffective, and there is a reluctance to expose patients to unnecessary toxic chemotherapies that do not provide a clinical benefit to the patient. Clinical experts noted that the outcomes for these patients are very poor. One clinical expert suggested that lomustine (CCNU) could be an option while another clinical expert acknowledged that despite its lack of effectiveness and risk of toxicities, CCNU has been suggested in the past as a last resort, due to the sensitive nature of treating children when pressured by parents to offer treatment over palliative care (28, 29). However, while there is evidence of activity in adults, there are no such evidence of activity in paediatric patients with relapsed/refractory glioma.

BSC/palliative care was therefore assumed in the economic model for patients who are relapsed/refractory previously treated with TMZ and was assumed to encompass pain and symptoms management and psychosocial support (Section B.3.5.2.4).

B.3.3 Clinical parameters and variables

The sources for the clinical parameters used in the economic model are summarised below in Table 40. Data from the final data-cut (DCO: 28th April 2023) of TADPOLE were used in the economic model (39).

Table 40: Summary of sources of data used in the economic model

Parameter	LGG	HGG	Reference in Submission
Baseline characteristics	TADPOLE (39)		Section B.3.3.1

Dabrafenib with trametinib for treating *BRAF* V600E mutation-positive glioma in children and young people aged 1 to 17

Parameter	LGG	HGG	Reference in Submission
PFS for LGG	TADPOLE (39)	N/A	Section B.3.3.2
PFS for HGG	N/A	TADPOLE (39)	Section B.3.3.3
Time to death following first progression (or PPS)	Kandels 2020 (79)	TADPOLE (39)	Section B.3.3.4
PFS for subsequent lines of treatment	Derived from Kandels 2020 (79) and TADPOLE (39)	N/A	Section B.3.3.5
TTD due to reasons other than progression	TADPOLE (39), supplemented by clinical advice (28, 29) (stopping rule)		Section B.3.3.6
UK life table	ONS (91)		Section B.3.3.7
Incidence of adverse events	TADPOLE (39)		Section B.3.3.8
Rate of malignant transformation	Kandels 2020 (79)	N/A	Section B.3.3.9
Event-free survival following malignant transformation	Jakacki 2020 (92)	N/A	Section B.3.3.10

Abbreviations: D, dabrafenib; HGG, high-grade glioma; HR, hazard ratio; LGG, low-grade glioma; N/A, not applicable; ONS, Office of National Statistics; PFS, progression-free survival; PPS, post-progression survival; sHGG, secondary high-grade glioma; T, trametinib; TTD, Time to treatment discontinuation.

B.3.3.1 Baseline characteristics

The baseline characteristics for the modelled cohort of patients were derived from the TADPOLE study (39), since the patients included in the trials were deemed representative of patients in England and Wales (Table 41) (29). Baseline characteristics were derived for LGG and HGG separately.

The age distributions from the trial were directly used in the model to simulate patient age at entry. The gender distribution was obtained from the TADPOLE study. The age and gender distributions assumed in the economic model are presented in Figure 20. The age and gender distributions were used in the model to (1) derive costs for D+T as the dosage in TADPOLE was dependent on age/weight, (2) incorporate the natural deterioration of QoL with age, and (3) to derive the time to death from non-glioma related causes (e.g. general population mortality) in conjunction with UK life tables (91). Scenario analyses were conducted using the age distribution reported in Kandels 2020 (79), and gender distribution from Kandels 2020 and Gneknow 2017. The impact on the cost-effectiveness results was minor (Section B.3.10.3 and Appendix Q).

Figure 20: Age and gender distribution assumed in the economic model

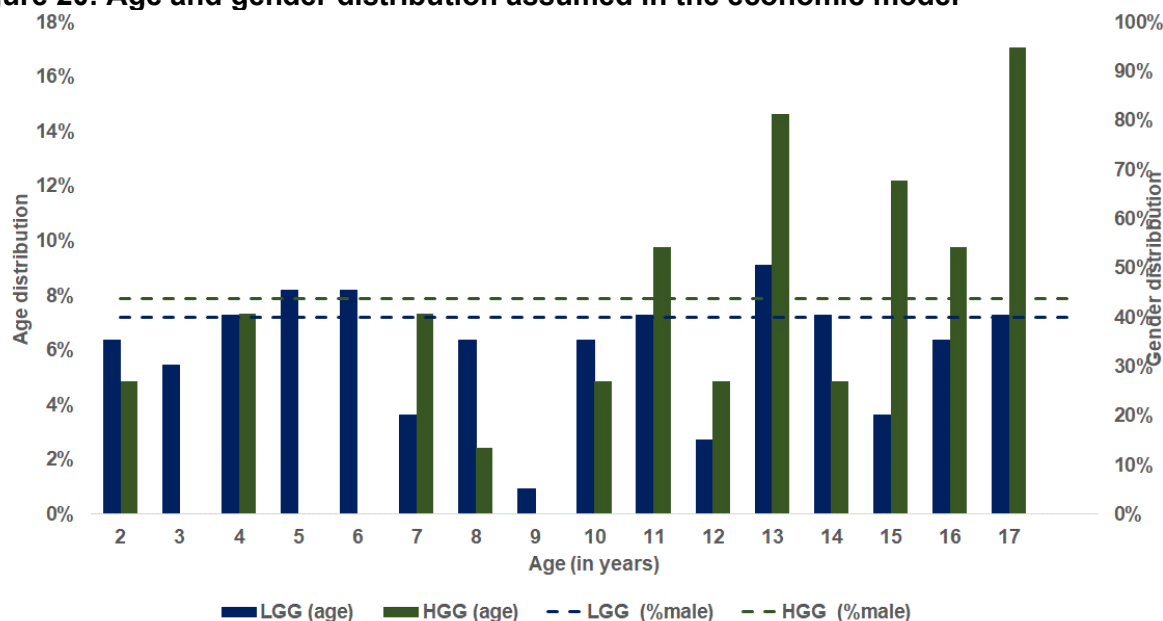

Source: Analysis of the TADPOLE trial (39).

Abbreviations: HGG, high-grade glioma; LGG, low-grade glioma.

While not directly used in the economic model, the mean/median age are presented in Table 41 for transparency and completeness. The mean weight (kg) and body surface area (BSA) were primarily used in the economic evaluation to calculate drug acquisition costs for chemotherapies.

Table 41: Baseline characteristics at entry

Baseline characteristics	TADPOLE	
	LGG	HGG
Age	9.1±4.96	12.12±4.45
% male	40.0%	43.9%
Weight (kg)	43.27±26.29	49.82±27.38
BSA (m ²)	1.26±0.51	N/A

Source: TADPOLE CSR (39).

Abbreviations: BSA, body surface area; HGG, high-grade glioma; LGG, low-grade glioma; N/A, not available.

B.3.3.2 Progression-free survival (first treatment) for LGG

The TADPOLE study measured PFS evaluated by independent review and investigator review using RANO criteria (39). The model base case used PFS as evaluated by the investigator (e.g. local assessment) review following clinical feedback (28, 29). Clinical experts indicated that PFS as assessed by the investigator is a more accurate reflection of when a patient would be deemed to have progressive disease in clinical practice, and is a more accurate reflection of the decision for when to stop treatment (28, 29). In the TADPOLE study, the decision to stop treatment was also based on the investigator review. Clinical experts explained that following a response (reduction in tumour size), a small change in the residual size of the tumour could trigger the event defined as progression according to RANO criteria, as this is defined as an increase in 25% from nadir rather than baseline (28, 29). Clinical experts indicated that there are also often variation in the tumour size and therefore they would typically continue treatment and do a second confirmatory

Dabrafenib with trametinib for treating *BRAF* V600E mutation-positive glioma in children and young people aged 1 to 17

scan to confirm that the increase in tumour size seen in the previous scan was not due to natural variation, but the tumour growing (28, 29). The economic model included the functionality to use results using PFS evaluated according to the independent review for transparency and completeness. Results from this scenario are presented in Section B.3.10.3 and Appendix Q.

B.3.3.2.1 Approach for PFS and KM

In the base case, PFS for chemotherapy (C+V) was derived using:

- **Phase 1:** The KM curve from TADPOLE up to the next to last observed event (Week 115), followed by;
- **Phase 2:** Log-normal parametric extrapolation from an independent model fitted to C+V, and applied up to the age of 25 years;
- **Phase 3:** No progression was assumed once patient reached adulthood (assumed to be 25 years of age).

Likewise, PFS for D+T was derived using:

- **Phase 1:** The KM curve from TADPOLE up to the next to last observed event (Week 193), followed by;
- **Phase 2:** Log-normal parametric extrapolation from an independent model fitted to C+V, and applied up to the age of 25 years. Therefore, the base case did not assume any treatment effect beyond the use of the KM and the same rate of rate of progression is used between arms;
- **Phase 3:** No progression was assumed once patient reach adulthood (assumed to be 25 years of age).

Justification for the approach

1. The KM was utilised, as parametric extrapolations did not result in a good fit within the observed period for C+V. Likewise, the application of a treatment effect did not result in a good fit to the KM for D+T (Appendix J).
2. The cut off point (next to last observed event) for the KM selected in the base case was chosen due to the low number of patients at risk after 2 years, and aligned with treatment duration (2–5 years) expected in practice with D+T
3. No progression was assumed once patient reach adulthood (age 25 years) in the base case to reflect clinical feedback that the rate of progression diminishes over time, and patients are unlikely to experience progression when reaching adulthood (28, 29).

Due to the uncertainty, different cut-off points applied to the KM (2 years, 2.5 years, 3 years, last observed event) were explored in scenario analysis, in addition to when no progression was assumed (between 19 and 27 years old). The impact on the cost-effectiveness results was modest (Section B.3.10.3 and Appendix Q).

The KM curve from the final PFS analysis of TADPOLE (DCO: 28th April 2023) is presented in Figure 21. A total 15 and 23 progression events (RANO progression, death) were recorded for C+V (n=37) and D+T (n=73), respectively.

Figure 21: Kaplan-Meier curve for PFS evaluated by investigator review

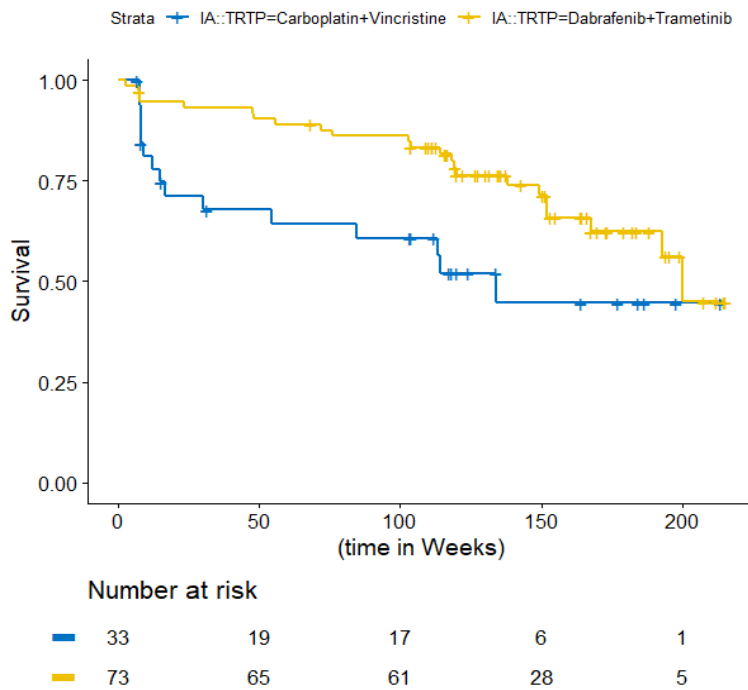

Source: Analysis of the TADPOLE trial (39).

Abbreviations: IA: investigator assessment; PFS, progression-free survival; TRTP: treatment arm.

B.3.3.2.2 Parametric extrapolation following KM

As highlighted in Section B.3.3.2.1, the same rate of progression was used after the KM (after the next to last observed event) in both the C+V and D+T arm. This was obtained from the rate of progression for patients on C+V from an independent model fitted to TADPOLE data. In scenario analyses, when the KM was not used or treatment duration was beyond the KM, the rate of progression was adjusted using a treatment effect (Section B.3.3.2.3).

In accordance with the NICE DSU TSD 14 (93), a range of standard parametric distributions (exponential, Weibull, Gompertz, log-logistic, log-normal and generalised gamma) and a flexible model (spline hazard model with one knot) were explored in the extrapolation of the clinical trial data beyond the observed period (Appendix P). More flexible models (e.g. addition of more than 1 knot) were initially explored but subsequently excluded due to overfitting.

Different parametric models incorporate different hazard functions. The NICE TSD 14 (93) also recommends that the most appropriate distribution is selected based on consideration of: (a) the visual fit of the predicted models to the observed KM, (b) the statistical goodness-of-fit of the model relative to all other fitted models (measured using the Akaike information criterion [AIC] or Bayesian information criterion [BIC]), (c) an assessment of the observed hazards, and (d) the plausibility of the long-term extrapolation.

The fit of each parametric function relative to the KM curve is presented in Appendix P. With the exception of the exponential, and the generalised gamma distributions (that did not converge), other distributions provided a reasonable visual fit to the observed KM (Appendix P), although sub-optimal.

The statistical goodness of fit in terms of AIC and BIC, was relatively similar between the different distributions (Appendix P), with the log-normal distribution having the lowest BIC, followed by the spline hazard model with one knot.

Whilst the statistical goodness of fit only provides an indication of the fit to the observed data, assessment of the plausibility of the long-term extrapolation beyond the observed period is important.

Assessment of the long-term extrapolation for PFS was informed by external data (20), supplemented by clinical feedback (28, 29). Lassaletta 2017 reported a five-year PFS after first-line chemotherapy for *BRAF* V600E mutation-positive paediatric patients with LGG from the SickKids cohort (n=34) of 30.4% (95% CI: 13.3, 47.5%) (20). The number of patients at risk after 5 years was low (n=7), with all patients subsequently censored and no event up to Year 25.

The Weibull, log-normal and log-logistic models predicted between 34–36% of patients would be progression-free at 5 years, aligning with the proportion reported by Lassaletta 2017 (20). The predictions using the Gompertz and spline hazard model were higher compared with Lassaletta 2017 at 45% and 42%, respectively.

Consequently, the base-case economic analysis adopted the log-normal model to extrapolate beyond the observed period (until patients reach 25 years of age), as this had the best statistical fit in terms of BIC, aligned with Lassaletta 2017 (20), and clinical expectation (28, 29).

For transparency, the fit to the data selected in the base case and extrapolation (lognormal) is presented in Figure 22 for both C+V and D+T, with (base case) and without the use of the KM (up to next to last observed event), assuming an hypothetical patient aged 15 years of age at entry (therefore no progression after 10 years, once the patient reach 25 years of age).

Figure 22: Extrapolation approach for PFS for LGG (hypothetical patient)

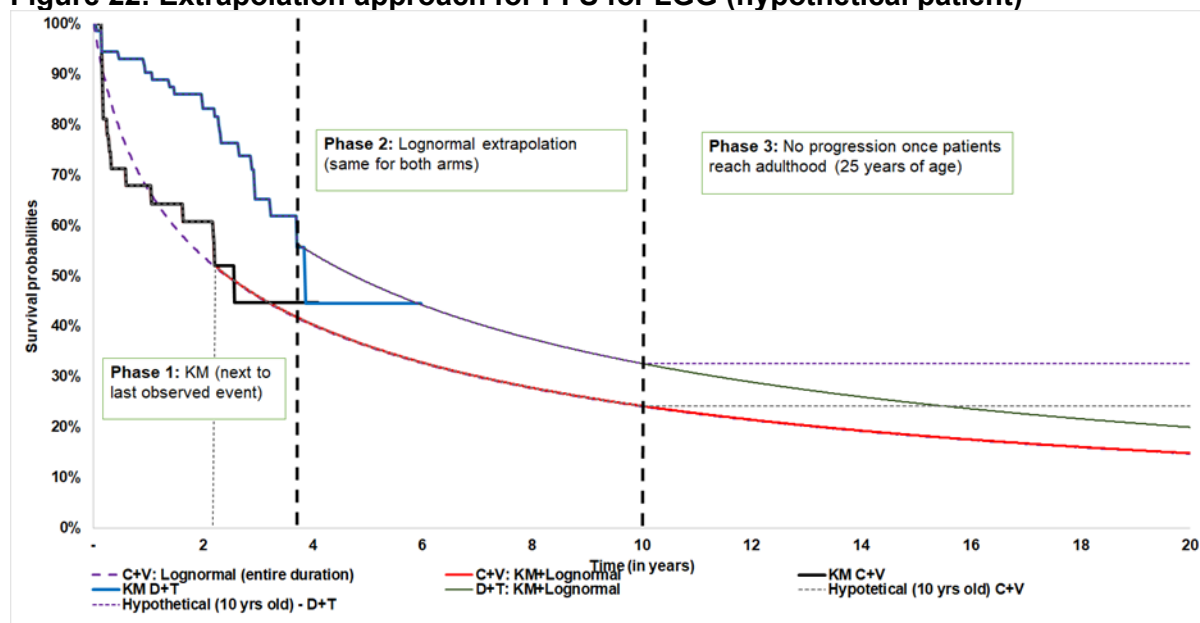

Source: Analysis of the TADPOLE trial (39).

Abbreviations: C, carboplatin; KM, Kaplan-Meier; PFS, progression-free survival, V, vincristine.

The choice of parametric extrapolation remains uncertain. Therefore, in line with the NICE TSD 14 (93), scenario analyses were conducted using alternative distributions (Section B.3.10.3 and Appendix Q). Scenario analyses are also conducted using parametric extrapolation during the entire duration (Section B.3.10.3 and Appendix Q).

Overall, the different plausible extrapolation methods had a modest impact on the cost-effectiveness results (Section B.3.10.3 and Appendix P).

B.3.3.2.3 Treatment effect for PFS for D+T (used in scenario analysis only)

In the base case, patients were assumed to be treated up to Week 193 to align with the use of KM data to estimate progression. This reflected clinical feedback that patients would be treated between 2–5 years. Consequently, no treatment effect was required in the base case, with the unadjusted rate of progression for chemotherapy (C+V) used for D+T beyond the KM. However, for scenarios where the KM was not used (parametric extrapolation for the entire model duration), or when the maximum time on treatment is different to the cut-off point used for the KM, the treatment effect for PFS (as assessed by the investigator) estimated in TADPOLE (D+T vs C+V) was applied to the hazard of C+V PFS curve. The treatment effect was only applied while patients remain on treatment, with no treatment effect assumed as soon as treatment is discontinued.

Table 42: Treatment effect assumed in the economic analysis (scenario analysis only)

Analysis	Hazard ratio
LGG (Section B.2.6.2.1.2.3)	0.46 (95% CI: 0.24, 0.88)

Source: Analysis of the TADPOLE trial (39).

Abbreviations: CI, confidence interval; HGG, high-grade glioma.; LGG, low-grade glioma.

B.3.3.3 PFS in patients with HGG

B.3.3.3.1 PFS in patients treated with D+T

A similar approach was employed for HGG for D+T with the KM curve used up to the next to last observed event, followed by parametric extrapolation. Compared with LGG, no constraints were added to assume that progression would not occur once a patient reached adulthood. Different cut-off points for the KM data (2 years, 2.5 years, 3 years, last observed event), or parametric extrapolation during the entire duration were explored in scenario analysis. The impact on the cost-effectiveness results was modest (Section B.3.10.3 and Appendix Q).

The KM curve from the final PFS analysis of TADPOLE (DCO: 28th April 2023) is presented in Figure 23. A total 24 progression events were recorded; ■ in patients previously treated with TMZ (n=■) and ■ in patients not previously exposed to TMZ (n=■), respectively. To reflect any potential difference in prognosis according to TMZ exposure, the base-case model utilised the data for each population separately (previously vs not previously exposed to TMZ). A scenario analysis was conducted assuming the same PFS for the two populations considered (Section B.3.10.3 and Appendix Q).

Figure 23: Kaplan-Meier curve for PFS for D+T measured by local assessment, HGG analysis

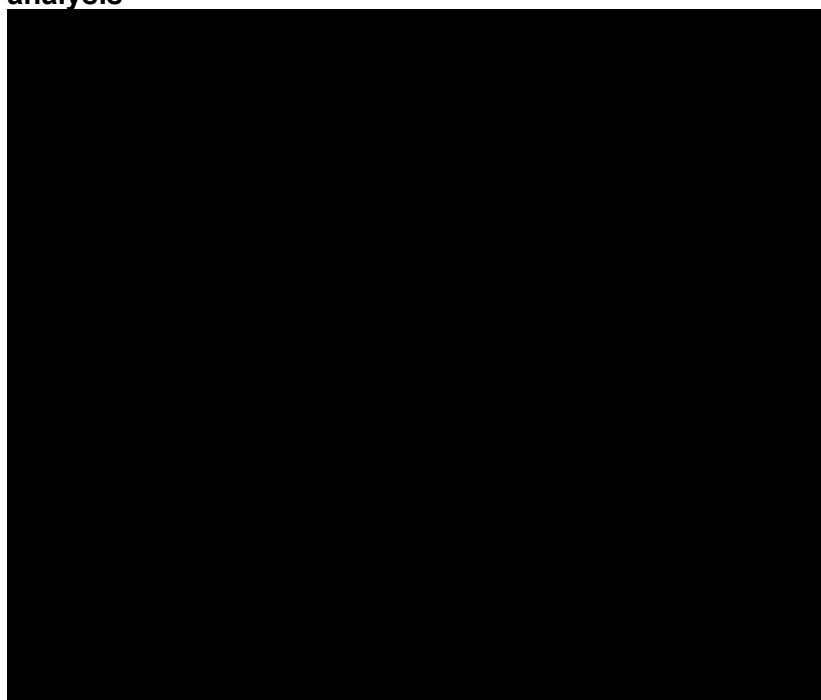

Source: Analysis of the TADPOLE trial (39).

Abbreviations: D, dabrafenib; PFS, progression-free survival; HGG, high-grade glioma; IA, Investigator assessment; N/A, not applicable; T, trametinib; TMZ, temozolomide.

Parametric functions were fitted to the data (Appendix P) and the selection process for the extrapolation of PFS was similar to that described previously in Section B.3.3.2.

In both populations, all of the examined distributions provided a suboptimal visual fit to the observed KM (Appendix P). The statistical goodness of fit in terms of AIC and BIC, was also relatively similar between the different distributions (Appendix P), with the exponential and

Dabrafenib with trametinib for treating *BRAF* V600E mutation-positive glioma in children and young people aged 1 to 17

log-normal distribution having the lowest AIC and BIC in patients with no exposure to TMZ and those previously treated with TMZ. However, the statistical goodness of fit only provides an indication of the fit to the observed data, therefore assessing the plausibility of the long-term extrapolation beyond the observed period is important. All distributions, apart from exponential led to a plateauing of the curve (Appendix P). Patients with relapsed/refractory HGG often have terminal disease and have poor OS with current standard of care. The long-term effect of D+T on survival and progression remain unclear, however, it was considered that assuming a plateau would likely be optimistic. Consequently, in the base case, in both populations, a pragmatic approach was used consisting of using the KM (due to the suboptimal visual fit) followed by the exponential (Figure 24).

Figure 24: Comparison of the KM and extrapolation method for D+T, PFS HGG

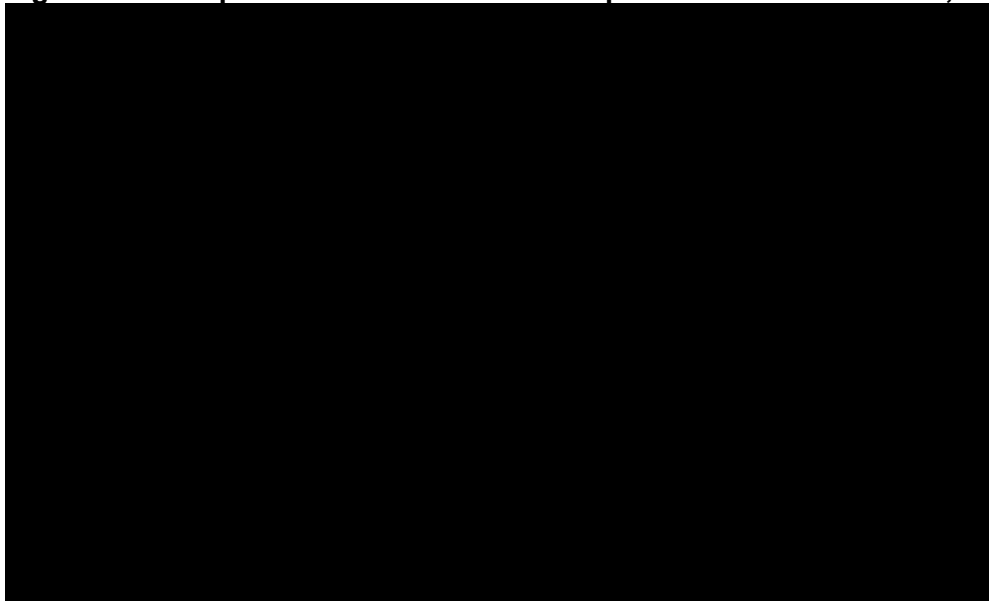

Source: Analysis of the TADPOLE trial (39).

Abbreviations: D, dabrafenib; exp, exponential; HGG: high-grade glioma; KM, Kaplan-Meier; PFS, progression-free survival; T, trametinib; TMZ, temozolomide.

The choice of parametric extrapolation remains uncertain. Therefore, in line with the NICE TSD 14 (93), scenario analyses were conducted using alternative distributions (Section B.3.10.3 and Appendix Q). Overall, the different plausible extrapolation methods had a large impact on the cost-effectiveness results (Section B.3.10.3 and Appendix Q), with alternative distributions leading to an improvement in cost-effectiveness due to the plateau of the curves.

B.3.3.3.2 Treatment effect for PFS for the comparator arm

- **No prior TMZ:** The treatment effect for PFS estimated from the ITC (Section B.2.9) was used in the economic model. The treatment effect was applied to the D+T PFS curve (Section B.3.3.2.3) to derive PFS for the comparator arm (TMZ). As the treatment effect is applied to the D+T arm to predict PFS for the comparator, the inverse of the treatment effect in Table 43 is used and applied to the D+T PFS.

Table 43: Treatment effects assumed in the economic analysis for the HGG analysis

Analysis	Hazard ratio
HGG – no prior TMZ (Section B.2.9.6)	██████████ (95% CI: ██████████, ██████████)

Abbreviations: CI, confidence interval; HGG, high-grade glioma; TMZ, temozolomide.

Prior TMZ

For the comparison against BSC, no PFS was assumed as the aim of BSC is to only relieve symptoms and associated tumour burden.

B.3.3.4 Time to death (glioma-related cause) following first progression

B.3.3.4.1 Time to death following first progression for patients with LGG following first line treatment

Owing to the indolent nature of LGG, data on OS is lacking, with no deaths in the D+T arm (n=73) and one death in the C+V arm (n=37) at the final OS analysis (DCO: 28th April 2023) of the TADPOLE study (of which 32.4% [n=12/37] crossover from C+V to D+T). External data were therefore sought to inform the relationship between PFS and OS (same relationship used in both arms). Two of the studies identified in the SLR, described in Section B.2.6, reported data on death following progression; however, none of these studies had information on the presence of a *BRAF* V600E mutation, and therefore, these studies are referred to as molecularly unselected (i.e. irrespective of the *BRAF* V600E mutation). While it should be acknowledged that using data from a broader population (*BRAF* V600E vs molecularly unselected) is not without limitations, clinical feedback independently indicated that although LGG patients with a *BRAF* V600E mutation have poorer response to chemotherapy, it was reasonable to use data from molecularly unselected patients as a proxy, as they would not expect significant differences in the time to death following progression between patients with a *BRAF* V600E and those without the mutation, but the difference would likely be in PFS and response to chemotherapy (28, 29).

- **Gnekow 2017** evaluated the addition of etoposide to C+V vs C+V alone (89). The mean age was 4.3 (SD: 3.3) years at diagnosis and 5.0 (SD: ±3.7) years at randomisation. At the start of treatment, 14.7% of patients randomised were younger than 1 year old, 66.0% were aged between 1 to 8 years, and 19.3% were between the ages of 8 and 16 years. The study reported a 5-year survival in those who progressed and were alive at 6 months of 46.4% vs a 5-year survival of 97.3% and 94.4% in patients who were either responders (CR/PR/OR) or with stable disease at 6 months
- **Kandels 2020** evaluated the efficacy of subsequent surgical and non-surgical therapies of the German cohort of the SIOP-LGG 2004 study (79). The median age at diagnosis was 7.6 years. In total, 4.8% of patients were younger than 1 year old, 47.2% were aged between 1 to 8 years, and 48.0% were aged between 8 and 16 years. The study reported the OS calculated from the date of the event (defined as relapse after complete resection, clinical or radiological progression, start of non-surgical/adjuvant therapy) following primary chemotherapy (C+V). The study demonstrated that patients with an event less than 18 months following start of chemotherapy (n=55), 5- and 10-year survival following the event was 64.5% and

Dabrafenib with trametinib for treating *BRAF* V600E mutation-positive glioma in children and young people aged 1 to 17

52.9%, respectively. In contrast, in those who experienced an event more than 18 months following start of chemotherapy (n=121), 5- and 10-year survival following the event was 94.3% and 92.3%, respectively.

Both studies demonstrate that early progressors have poorer outcomes compared with late progressors, suggesting that the timing of progression is important in determining the future outcomes of patients. The base-case economic model used data from Kandels 2020 to inform the relationship between PFS and OS (79). This is because the study reported survival following the event, rather than according to response at 6 months. Likewise, compared with Kandels 2020, a larger proportion of patients under 1 year old (14.6% vs 4.8%) were included in Gnekow 2017 (89) and a lower proportion of patients over 8 years old were included (19.3% vs 48.0%), which may make this study less representative of the population included in TADPOLE and general UK practice. Using evidence from Kandels 2020 was also supported by clinical feedback (28, 29). As the study only reported survival at 5- and 10 years following an event, a piecewise exponential was used (e.g. assuming a constant rate between Year 0–5 and Year 5–10), with the rate estimated in the latter segment extrapolated over the lifetime of the patient. The estimated time to death following progression for early (<18 months) and late progressors (≥18 months) is presented in Figure 25. It should be noted that PPS was applied at the point of first progression (and not subsequent treatment lines), as the study reported on the death rate following first progression only.

Figure 25: Survival probabilities for early (<18 month) and late progressors (≥18 months) used in the economic analysis, LGG

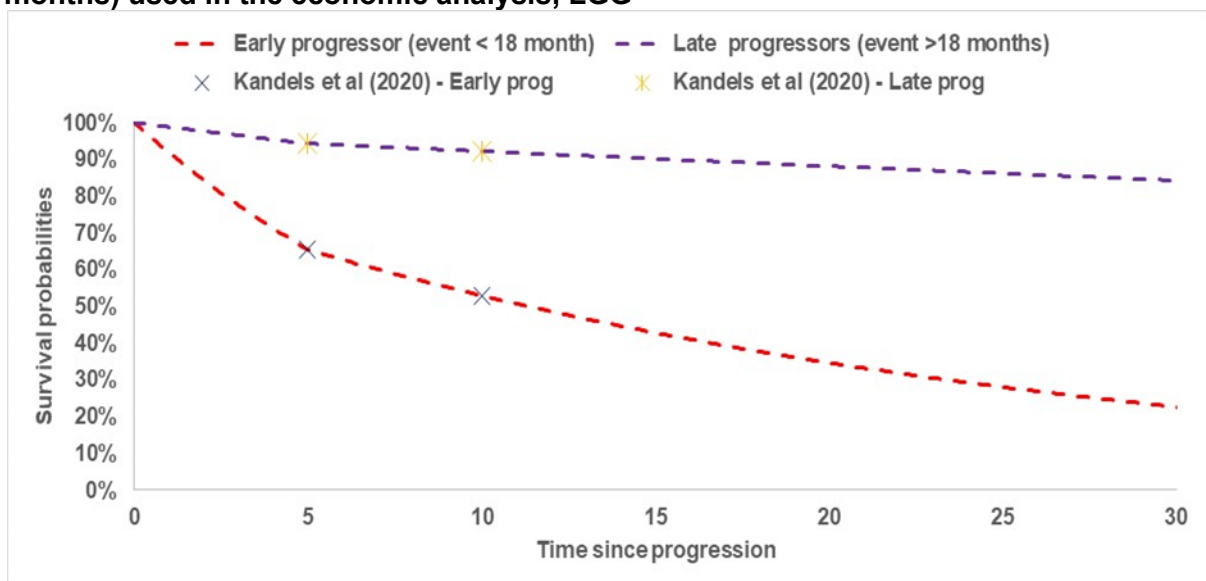

Source: Derived from Kandels 2020 (79).
Abbreviations: LGG, low-grade glioma; prog, progressors.

Due to the uncertainty in using data from molecularly unselected patients, scenario analysis was conducted to reduce the rate of death following progression reported by Kandels 2020 by 10% and 20%, respectively. This scenario had a modest impact on the cost-effectiveness results (Section B.3.10.3 and Appendix Q).

A scenario analysis was also conducted using data reported in Gnekow 2017 (89). For this scenario, the post-progression survival for those with a response was estimated from the

PFS and OS curve at 6 months, as reported in the study. This scenario had a modest impact on the cost-effectiveness results (Section B.3.10.3 and Appendix Q).

B.3.3.4.2 Time to death following progression for the HGG analysis.

Survival following progression/start of anti-neoplastic therapies (or post-progression survival [PPS]) was estimated from the TADPOLE study and assumed to be the same for both D+T and SoC. Using the same PPS for D+T and SoC helps mitigate some of the uncertainty of comparing survival outcomes from different studies, conducted in different population (*BRAF* V600E vs molecularly unselected) and potential differences in management/salvage therapies given post-progression. Clinical experts confirmed this was appropriate.(28, 29)

IPD from TADPOLE (39) were obtained and analysed to estimate the time to death following progression/start of anti-neoplastic therapies. The KM curve for the analysis of time to death following progression/start of anti-neoplastic therapies is presented in Figure 26 (n=■). A total of ■ events were observed. In the absence of difference between patients previously treated or not treated with TMZ, pooled data were used in the economic analysis to increase the statistical power and reduce the uncertainty.

Figure 26: KM plot for the time to death following D+T discontinuation and/or start of anti-neoplastic therapy



Source: Analysis of the TADPOLE trial (39).
Abbreviations: D, dabrafenib; KM, Kaplan–Meier; T, trametinib; TMZ, temozolomide.

It was that ■■■% die upon progression in the D+T arm, derived from the total number of progression events (n=■■■) and reported number of death (n=■■■) due to progression (Section B.2.6.2.2.2.3).

The selection process for the extrapolation for the time to death following progression (PPS) was similar to that described in Section B.3.3.2. The fit of each parametric function relative to the KM curve is presented in Appendix P. All distributions provided a good visual fit to the observed KM. The statistical goodness of fit in terms of AIC and BIC, was also relatively similar between the different distributions (Appendix P), with the exponential distribution having the lowest AIC and BIC.

The exponential distribution was selected in the base case, as it provided (a) a good visual fit, (b) had the best statistical fit in terms of BIC (c) reflected the poor prognosis following progression, and (d) was consistent with other distributions. The choice of parametric extrapolation remains uncertain. Therefore, in line with the NICE TSD 14 (93), scenario analyses were conducted using alternative distributions (Section B.3.10.3 and Appendix Q). Overall, the different plausible extrapolation methods had a modest impact on the cost-effectiveness results (Section B.3.10.3 and Appendix Q).

Figure 27: Comparison of the KM and parametric fit for PPS

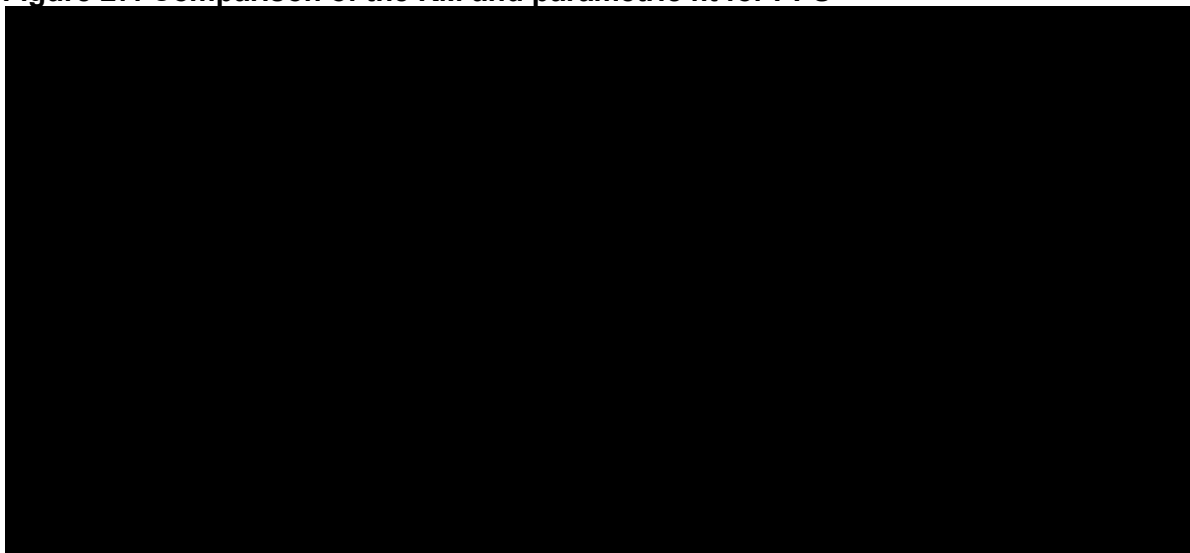

Source: Analysis of the TADPOLE trial (39).

Abbreviations: exp, exponential; KM, Kaplan-Meier; PPS, post-progression survival.

Clinical experts independently explained that the prognosis for patients who received TMZ upfront and are relapsed/refractory is very poor with patients expected to survive between 3 to 6 months (28, 29). Clinical experts further indicated that chemotherapies are not efficacious in this setting. Two studies were identified during the SLR process reporting outcomes in patients pre-treated with TMZ; one study was included in the SLR; with an additional one subsequently excluded, as it did not meet the minimum sample requirement (n<15). MacDonald 2013 (94) reported a median survival of 172 days in a Phase 2 study of cilengitide in paediatric patients with refractory or relapsed HGG (n=24), of which 87% (n=20/23) with known treatment history received prior TMZ. Likewise, Narayana 2010 (95) reported a median survival of 6.25 months in a Phase 2 study of bevacizumab in paediatric patients with refractory or relapsed HGG (n=12) of which 92% (n=11/12) received prior TMZ.

Clinical experts indicated that while data from these studies were from a molecularly unselected cohort, outcomes were in line with their clinical expectation, and they would not expect any substantive difference in patients with a *BRAF* V600E mutation (28, 29). The clinical experts also confirmed that it was reasonable to use outcomes from these studies as a proxy for BSC, as chemotherapy is not considered efficacious in this setting. The KM for OS from these studies was compared with the PPS for D+T (Figure 28) to confirm whether using PPS was a reasonable proxy for OS. Consequently, in the base case, PPS for D+T was used as a proxy for outcomes for patients on BSC. Scenario analyses were also conducted using data from MacDonald 2013 (94) and Narayana 2010 (95) separately (Section B.3.10.3 and Appendix Q) and had little impact on the ICER.

Figure 28: Comparison of the KM for PPS for D+T and OS from MacDonald 2013 and Narayana 2010

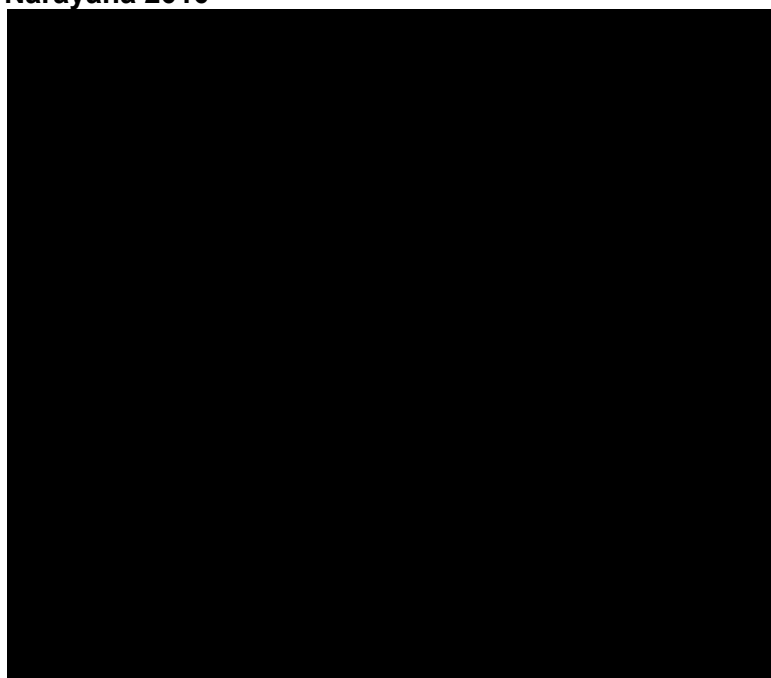

Source: MacDonald 2013 and Narayana 2010, analysis of TADPOLE IPD (39).
Abbreviations: OS, overall survival; PPS, post-progression survival.

B.3.3.5 PFS for subsequent progression events/lines of treatment, LGG analysis

Modelling the clinical pathway for glioma following first-line chemotherapy is extremely challenging and data intensive due to the different treatment modalities (surgical, non-surgical [chemotherapy, radiotherapy], no treatment), administered individually or in combination (79).

Glioma is a progressive disease, and therefore assuming a single '*progressed disease*' health state is not appropriate, as patients may experience several progression events and receive numerous lines of treatment over the lifetime. The economic model considered up to five progressions in order to capture the costs associated with subsequent treatments and their impact on QoL. It should however be noted that no progression was assumed once patients reached 25 years of age. In the economic model, the time to next progression was informed by PFS after subsequent chemotherapy (given alone or in combination with surgery/radiotherapy) reported in Kandels 2020, for simplicity (79). This was considered reasonable by clinical experts, given that the majority of patients would receive chemotherapy following progression, as evidenced in Kandels 2020 (79). Likewise, while time to progression on chemotherapy was used to reflect the timing of progression, the cost following progression in the model aligned with the distribution of treatments (chemotherapy, surgery, radiotherapy) patients were expected to receive following progression, or no treatment (Section B.3.5.2.2).

In the economic model, the time to subsequent progression (2nd–5th progression) was estimated by applying a treatment effect derived from Kandels 2020 (79). In the model, the time to subsequent progression (2nd–5th progression) was estimated by applying a treatment

effect derived from Kandels 2020 (79) to the PFS for first-line chemotherapy in TADPOLE (Section B.3.3.2), and was assumed to follow a log-normal distribution. PFS assumed in subsequent lines of treatment is presented in Figure 29.

Figure 29: PFS assumed in subsequent lines of treatment/ progression

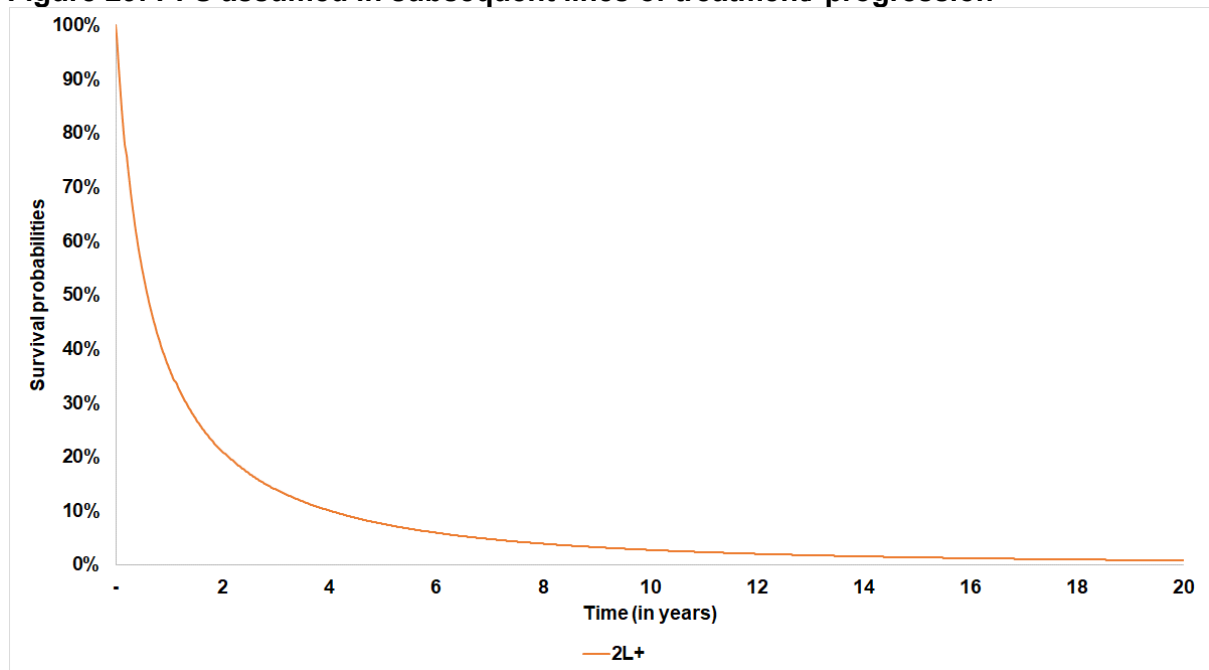

Source: derived from TADPOLE (39) and Kandels 2020 (79).

Abbreviations: PFS, progression-free survival; 1L, first-line; 2L+, second-line plus.

Kandels 2020 reported the 3-year PFS following first-line chemotherapy (53.5%) and following second-line chemotherapy (20.6%) for patients with non-neurofibromatosis type 1 (NF1) cancer predisposition syndrome (79). It is therefore possible to approximate an HR between first-line and second-line chemotherapy of ~ 2.53 ($-\ln[0.535]/-\ln[0.206]$). It should be noted that this is an approximation based on a single time point. The study further reported broadly similar PFS in non-NF1 patients receiving 2–4 lines of chemotherapy, suggesting that it is reasonable to assume the same PFS for subsequent lines of treatments.

It should be noted that PFS for subsequent treatments only drive the time in subsequent treatment lines in the model (for cost and quality of life), with OS estimated from the first progression time only (Section B.3.3.2) in line with evidence from Kandels et al (2020).

A scenario analysis (Section B.3.10.3) excluding the impact of subsequent progression was conducted, which had a modest impact on the cost-effectiveness results.

B.3.3.6 Time-to-treatment discontinuation due to AEs

According to the draft SmPC, treatment with D+T should continue until disease progression or until the development of unacceptable toxicity. The draft SmPC further states that there is uncertainty about the effectiveness of D+T in patients over the age of 17 years. Clinical experts independently confirmed that treatment would be stopped once patients progress.(28, 29) However, as highlighted in Section B.3.2.8.1, clinical experts further explained that as with current chemotherapies, in the absence of progression, treatment would be stopped after 2–5 years in paediatric patients with LGG to avoid exposure to unnecessary treatment and potential adverse effects (28, 29).

The reason for discontinuation was recorded in the trial and included AEs, subject/guardian decision, start of new therapy, progressive disease, and physician decision.

Progression and discontinuation were competing events in the model, in that patients discontinued treatment if they progress. Progression was already modelled and therefore discontinuation due to progression/efficacy were already accounted for. Consequently, only discontinuations due to reasons other than efficacy (e.g. AE or patient/guardian decision consent) were considered as events to avoid double counting.

The KM curves for the analysis of time to treatment discontinuation due to reasons other than progression is presented in Figure 30.

Figure 30: KM for the time to treatment discontinuation due to reasons other than progression

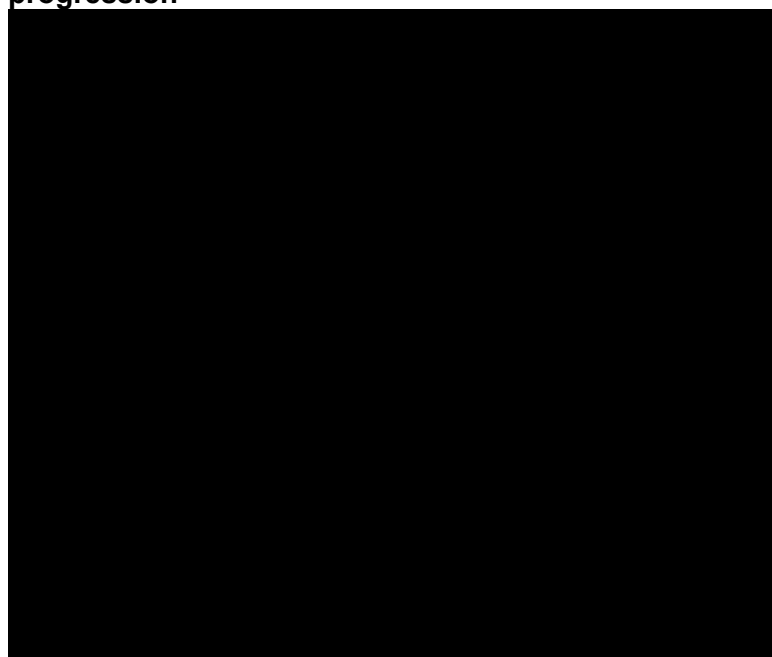

Source: Analysis of the TADPOLE trial IPD (39).

Abbreviations: HGG, high-grade glioma; IPD, individual patient data; KM, Kaplan–Meier; LGG, low-grade glioma.

Parametric functions were fitted to the data (Appendix P) and the selection process for the extrapolation of TTD was similar to that described previously in Section B.3.3.2. In summary, the generalised gamma distribution did not converge in both the LGG and HGG analysis. Likewise, the Weibull and spline model did not converge for the HGG analysis due to the low

number of events. The visual fit and long-term extrapolation was similar between the remaining curves examined (Appendix P).

The exponential distribution was used in the base case, as this had the best statistical fit (lowest AIC/BIC; Appendix P). Assuming a constant rate can be deemed more realistic considering the small number of events. Alternative distributions were explored in scenario analysis, in addition to using the fit to each trial individually. The impact on the cost-effectiveness results was minor (Section B.3.10.3 and Appendix Q).

Figure 31: Comparison of the KM and parametric for parametric distribution fit for TTD for D+T

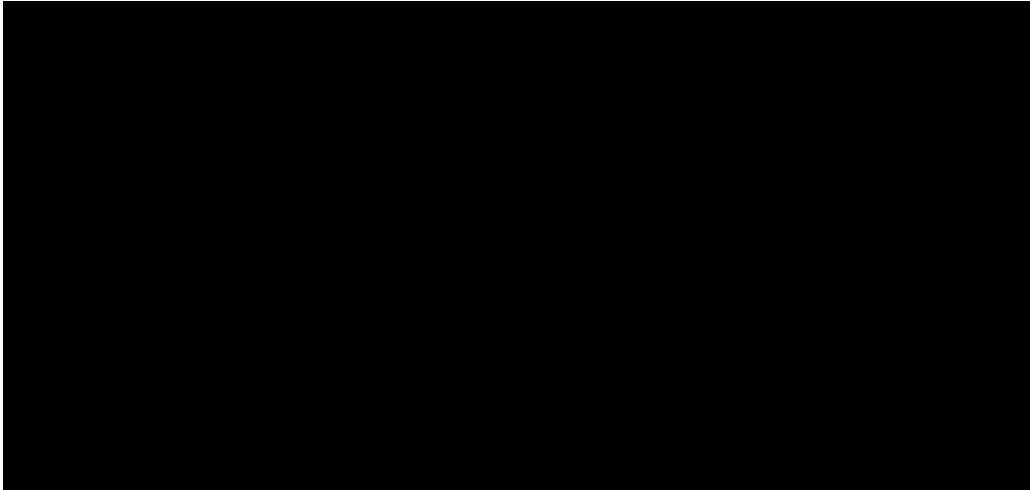

Source: Analysis of the TADPOLE trial (39).
 Abbreviations: D, dabrafenib; exp, exponential; HGG, high-grade glioma; KM, Kaplan–Meier; LGG, low-grade glioma; T, trametinib; TTD, time to discontinuation.

B.3.3.7 UK life tables

Age- and gender-specific hazard rates of death were obtained from published national life tables for England, using ONS data for 2018–2020 (91). Life tables were used in the model to estimate the time to death in the absence of glioma (referred here as non-glioma related death) to ensure the predicted time to death did not fall above that of someone without the condition. A Gompertz distribution was fitted to the ONS data for males and females separately (Figure 32), and time to event was sampled; conditional on a patient being alive at model entry.

Figure 32: Comparison of the survival taken from national life tables and Gompertz fit

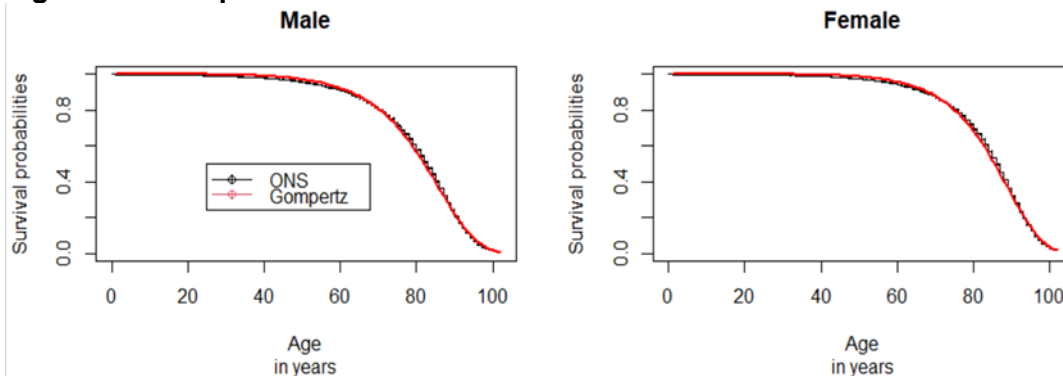

Source: Derived from ONS (91).
 Abbreviations: ONS, Office of National Statistics.

B.3.3.8 Incidence of adverse events

Results from TADPOLE demonstrate that D+T is generally well tolerated in patients with glioma (Section B.2.10). The overall pattern of AEs observed was also consistent with that reported in adults in other indications.

The potential impact of AEs on costs and HRQoL were included in the model; the base case economic analysis considered Grade 3/4 AEs that were suspected to be related to the study drug (where Grade 3/4 occurred in more than 2% of patients in either group) that were likely to affect either HRQoL or resource use (Table 44). For D+T, data from LGG and HGG were pooled to increase sample size in the base case. For the HGG analysis, the rate of AE on TMZ was obtained from Verschuur 2004 (66).

Table 44: Incidence of Grade 3/4 adverse events used in the economic analysis

Adverse event	D+T (n=114)	C+V (n=33)	TMZ (n=20)
Source	TADPOLE (39)	TADPOLE (39)	Verschuur 2004 (66)
Neutrophil count decreased			(0%)
White blood cell count decreased			(0%)
Alanine aminotransferase increased			(0%)
Lymphocyte count decreased			(0%)
Platelet count decreased			(0%)
Blood creatine phosphokinase increased			(0%)
Gamma-glutamyltransferase increased			(0%)
Hypomagnesaemia			(0%)
Aspartate aminotransferase increased			(0%)
Ejection fraction decreased			(0%)
Amylase increased			(0%)
Lipase increased			(0%)
Hypersensitivity			(0%)
Abdominal infection			(0%)
Device related infection			(0%)
Infusion related reaction			(0%)
Viral infection			(0%)
Rash			(0%)
Urticaria			(0%)
Flushing			(0%)
Hypertension			(0%)
Hypotension			(0%)
Headache			(0%)
Dizziness			(0%)
Gastrointestinal haemorrhage			(0%)
Diarrhoea			(0%)
Agitation			(0%)
Confusional state			(0%)
Peripheral motor neuropathy			(0%)
Peripheral sensory neuropathy			(0%)
Uterine haemorrhage			(0%)

Adverse event	D+T (n=114)	C+V (n=33)	TMZ (n=20)
Source	TADPOLE (39)	TADPOLE (39)	Verschuur 2004 (66)
Anaemia	████████	████████	(0%)
Neutropenia	████████	████████	8 (40%)
Thrombocytopenia	████████	████████	8 (40%)
Pyrexia	████████	████████	(0%)
Weight increased	████████	████████	(0%)
Uveitis	████████	████████	(0%)
Vomiting	████████	████████	(0%)
Pancreatitis	████████	████████	(0%)
Influenza like illness	████████	████████	(0%)
Brain oedema	████████	████████	(0%)

Source: Derived from TADPOLE (39); Verschuur 2004) (66).

Abbreviations: C, carboplatin; D, dabrafenib; T, trametinib; TMZ: temozolomide; V, vincristine.

Scenario analyses were conducted using the rate of AEs for LGG and HGG separately or removing the impact of AEs. Overall, the different assumptions around AEs had a limited impact on the cost-effectiveness results (Section B.3.10.3 and Appendix Q).

B.3.3.9 Rate of malignant transformation

Unlike LGG in adults, LGG tumours in children rarely undergo malignant transformation. Kandels 2020 reported 26 malignant transformations amongst 1,558 paediatric patients after 14 years, resulting in a 10-year malignant transformation rate from diagnosis of 1.8% (79). Lassaletta 2017 reported a 4% and 2.7% transformation rate in the *BRAF* V600E-mutated SickKids cohort (n=99) and independent cohort (n=180), respectively (20). However, the follow-up duration was not reported.

In the base-case model, an annual rate of 0.18% was assumed in both arms (e.g. no difference between treatment arms) based on Kandels 2020 and applied for the first 15 years only, after which, no malignant transformation is assumed. Scenario analyses varying the maximum time to malignant transformation were conducted (Section B.3.10.3 and Appendix Q). Overall, the different assumptions around the maximum time to malignant transformation had a limited impact on the cost-effectiveness results.

B.3.3.10 Survival following malignant transformation

The survival following malignant transformation was derived from the EFS rates reported in Jakacki 2016 (92) for first-line treatment (Figure 33), and PPS used for the HGG analysis was estimated from TADPOLE (Figure 27).

The KM for EFS (n=108) (92) was digitised, and pseudo-IPD were generated. The selection process for extrapolation was similar to that described in Section B.3.3.2. The fit of each parametric function relative to the KM curve is presented in Appendix P. Apart from the exponential and generalised gamma distribution (that did not converge), other distributions provided a reasonable fit to the observed KM. The statistical goodness of fit in terms of AIC and BIC, was relatively similar between the different distributions (Appendix P), with the log-normal distribution having the lowest AIC and BIC.

Dabrafenib with trametinib for treating *BRAF* V600E mutation-positive glioma in children and young people aged 1 to 17

Figure 33: Comparison of the KM and parametric distribution fit for EFS following malignant transformation

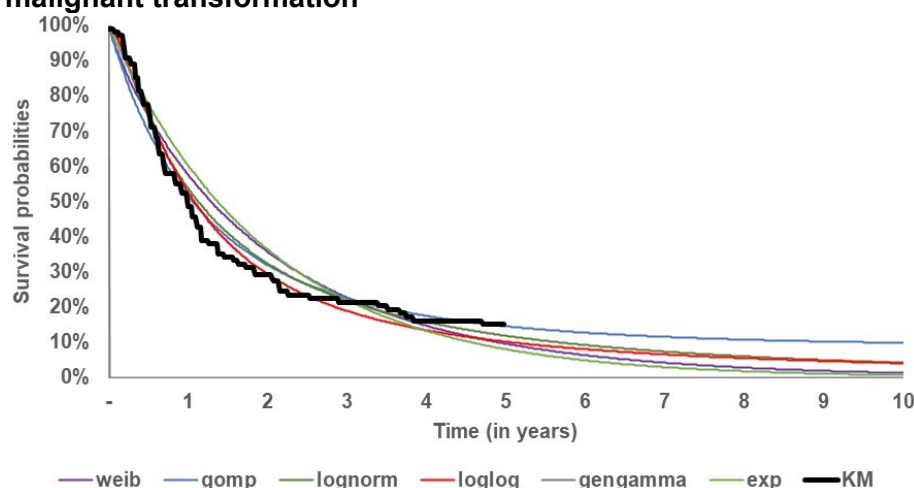

Source: derived from Jakacki 2016 (92).

Abbreviations: EFS, event-free survival; exp, exponential; gengam, generalised gamma; gomp, Gompertz; KM, Kaplan-Meier; Inorm, log-normal; llog, log-logistic; weib, Weibull.

The Weibull distribution was selected in the base case, as it was associated with less of a plateau effect compared with other distributions. Alternative distributions were explored in scenario analysis (Section B.3.10.3). Overall, the different extrapolation methods had a modest impact on results (Section B.3.10.3 and Appendix Q).

In summary, patients on D+T were modelled to experience higher PFS and OS vs the comparator in each of the LGG, HGG (no prior TMZ), and HGG (prior TMZ) populations, respectively

Survival extrapolation results

Years	LGG cohort				HGG cohort - No prior TMZ				HGG cohort - Prior TMZ			
	C+V		D+T		TMZ		D+T		BSC		D+T	
	PFS	OS	PFS	OS	PFS	OS	PFS	OS	PFS	OS	PFS	OS
0.5	0.70	0.99	0.93	1.00	0.15	0.81	0.83	0.97	N/A	0.58	0.58	0.89
1	0.66	0.98	0.90	0.99	0.07	0.50	0.77	0.90	N/A	0.32	0.58	0.75
2	0.59	0.96	0.82	0.99	0.02	0.17	0.65	0.73	N/A	0.10	0.39	0.53
3	0.45	0.94	0.63	0.98	0.00	0.06	0.55	0.65	N/A	0.03	0.22	0.35
4	0.38	0.91	0.52	0.97	0.00	0.02	0.46	0.55	N/A	0.01	0.14	0.23
5	0.35	0.89	0.47	0.96	0.00	0.01	0.37	0.45	N/A	0.01	0.09	0.15
10	0.23	0.82	0.31	0.91	0.00	0.00	0.13	0.16	N/A	0.00	0.01	0.02
15	0.19	0.75	0.26	0.87	0.00	0.00	0.06	0.06	N/A	0.00	0.00	0.00
20	0.18	0.71	0.23	0.84	0.00	0.00	0.02	0.02	N/A	0.00	0.00	0.00
30	0.17	0.64	0.23	0.79	0.00	0.00	0.00	0.00	N/A	0.00	0.00	0.00
40	0.17	0.58	0.22	0.74	0.00	0.00	0.00	0.00	N/A	0.00	0.00	0.00
50	0.16	0.52	0.21	0.68	0.00	0.00	0.00	0.00	N/A	0.00	0.00	0.00

Abbreviations: BSC, best supportive care; C, carboplatin; D, dabrafenib; HGG, high-grade glioma; LGG, low-grade glioma; N/A, not applicable; OS, overall survival; PFS, progression-free survival; T, trametinib; TMZ, temozolomide; V, vincristine.

B.3.4 Measurement and valuation of health effects

B.3.4.1 Health-related quality-of-life data from clinical trials

The PROMIS Parent Proxy Global Health 7+2 was used to evaluate the HRQoL of patients in the LGG cohort (Section B.2.6.2.1.2.5). No EuroQol five-dimensions (EQ-5D) data were collected during TADPOLE (39).

B.3.4.2 Mapping

There is no available mapping algorithm between the PROMIS Parent proxy and EQ-5D.

B.3.4.3 Health-related quality of life studies

B.3.4.3.1 Health state utility value studies

An SLR was conducted to identify health state utility value (HSUV) studies relevant to the decision problem from the published literature. A complete description of the search strategy is presented in Appendix H.

B.3.4.3.2 Description of identified studies

The SLR identified 26 studies that met the pre-defined inclusion criteria (18 full-text publications, seven conference abstracts, and one conference poster). Eight of the included studies clearly met the NICE reference case (78) in terms of requirements for HSUV evidence, i.e. health states should be described by patients and valued using UK societal values. In addition, seven studies had unclear relevance to the NICE reference case, and the remaining 11 studies were not relevant to the reference case. The included studies are detailed in Appendix H.

To focus on the most relevant evidence, only studies reporting EQ-5D data were included. However, an exception was made to include the HSUV data reported in a cost-utility analysis published by Garside 2007 (96) and its associated technology appraisal TA121, as TA121 was accepted by NICE (97).

A PRISMA diagram showing the overall flow of studies across the review is presented in Appendix H, together with a complete list of studies excluded after the full-text review stage.

B.3.4.4 Adverse events

The base-case model includes the impact of AEs on HRQoL. The health disutility associated with a particular AE was calculated based on the health utility decrement expected from an AE and its duration. For simplicity, a disutility of -0.075 lasting 7 days was assumed for all Grade 3 or 4 AEs, based on results from a multivariate regression model used in NICE TA772 (98).

For C+V (LGG analysis) and TMZ (HGG analysis), a one-off QALY loss was applied at model entry for simplicity, as most AEs were likely to have been captured within the study period. This was calculated by multiplying the frequency of AEs reported in Table 44 by the

Dabrafenib with trametinib for treating *BRAF* V600E mutation-positive glioma in children and young people aged 1 to 17

disutility and duration assumed for Grade 3/4, leading to a decrement in QALYs of -0.00280 for C+V and -0.00115 for TMZ.

For D+T however, treatment duration could be extrapolated beyond that observed in the trial. Consequently, the incidence of AEs for D+T was adjusted for exposure and applied in the model during the duration of treatment assuming an annual decrement of -0.00083 .

Scenario analyses were conducted removing the impact of AEs on QoL. As expected, the impact on the cost-effectiveness results was modest (Section B.3.10.3 and Appendix Q).

B.3.4.5 Health-related quality-of-life data used in the cost-effectiveness analysis

The decrement in utility values used in the cost-effectiveness model to derive the utility values for the different health states are presented in Table 45. These decrements were applied to the background general population utility values by age and gender (e.g. in patients without the condition). Evidence from an adult population was used due to the lack of EQ-5D data in children (81, 82). Due to the uncertainty of using data from adults, scenario analyses were conducted varying utility values (Section B.3.10.3 and Appendix Q). Overall, difference assumptions on utility values had a modest impact on the cost-effectiveness results (Section B.3.10.3 and Appendix Q).

B.3.4.5.1 Background general population EQ-5D values by age and gender – in patients without the condition

In line with the NICE methods guide (78), the background utility values accounted for the reduction in QoL as patients get older (Figure 34), based on the utility values by age and gender reported by Hernandez Alava 2023 (83).

As EQ-5D data were not collected in patients aged less than 16 years, the EQ-5D from people aged 16 years (general population) reported by Hernandez Alava 2023 (83) was assumed between 1–15 years in the economic model.

Figure 34: Background EQ-5D in people without the condition (general population – healthy adults)

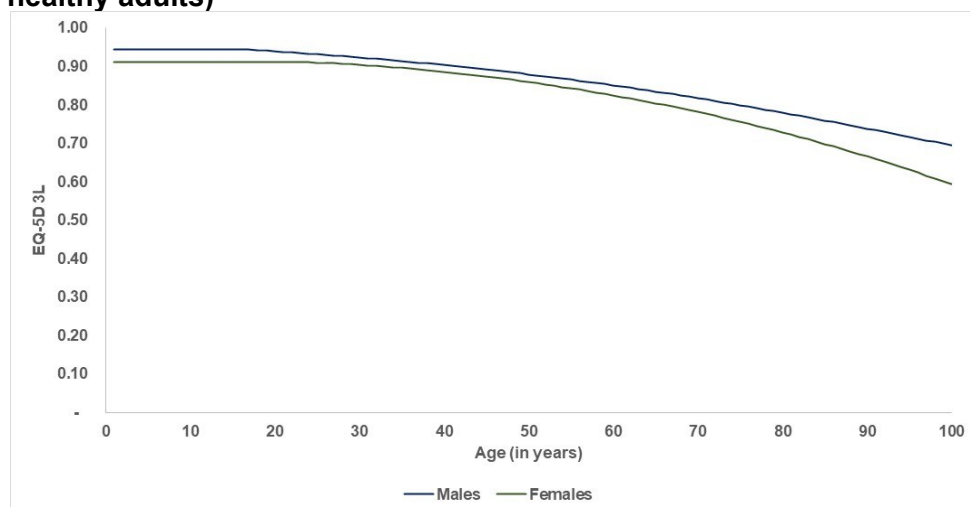

Source: derived from Hernandez Alava 2023 (83).

Abbreviations: EQ-5D 3L, EuroQol five-dimensions three levels.

Dabrafenib with trametinib for treating *BRAF* V600E mutation-positive glioma in children and young people aged 1 to 17

B.3.4.5.2 Decrement in EQ-5D for paediatric patients with LGG at model entry (relative to patients without the condition)

A decrement in EQ-5D of -0.155 (relative to people without the condition) was assumed in the economic model to reflect the reduction in HRQoL associated with the diagnosis of LGG compared with patients without the condition.

A number of studies reports on the EQ-5D in patients with LGG at diagnosis or those who had prior surgery. For instance, Drewes 2018 reported the EuroQol five-dimensions three levels (EQ-5D 3L; UK value set) in adult patients undergoing primary LGG surgery (mean age: 46.7 ± 16.2 , $n=40$) at baseline (EQ-5D: 0.76 [range: 0.03, 1.0]) and at 6 months (EQ-5D: 0.78 [range: -0.1 , 1.0]) in Norway (81). Likewise, Jakola 2012 reported a mean EQ-5D score (UK value set) of 0.76 for eloquent LGG and 0.74 for non-eloquent supratentorial LGG Grade II (mean age: 41 ± 13 , $n=55$) in Norwegian adult patients receiving surgery due to newly diagnosed LGG (99). Buvarp 2021 reported the EQ-5D 3L (0.67, $n=51$, UK value set) in Swedish patients with suspected diffuse LGG prior to surgery (mean age: 49 ± 13 years) (100).

Using the EQ-5D index population norms for adults aged 45–54 years in England (0.855) (101) and EQ-5D reported by Drewes 2018 (0.76) (81), the decrement in EQ-5D from LGG diagnosis was estimated as -0.095 .

In TADPOLE, patients with progressive disease after surgery or non-surgical patients requiring systemic treatment were enrolled (39). Therefore, an additional decrement of -0.06 was assumed based on the change in EQ-5D reported in patients with malignant glioma at the time of disease progression (82).

Due to the uncertainty, scenario analysis were conducted, assuming a decrement in utility at entry for the LGG cohort (compared with general population) ranging between -0.05 to -0.2 (Section B.3.10.3 and Appendix Q). Overall, difference assumptions on utility values had a modest impact on the cost-effectiveness results (Section B.3.10.3 and Appendix Q).

B.3.4.5.3 Decrement in EQ-5D for paediatric patients with HGG that are relapsed/refractory at model entry (relative to patients without the condition)

Vera et al (2023) reported the EQ-5D in US patients (median age: 52 years) with malignant glioma ($n=154$) with disease progression (0.7) (82). Using the EQ-5D index population norms for adults aged 45–54 years in the US (0.855) (101), the decrement in EQ-5D (relative to patients without the condition) associated with the diagnosis of relapsed/refractory HGG was estimated to be -0.155 .

Due to the uncertainty, scenario analysis were conducted assuming a decrement in utility at entry for the HGG cohort (compared with general population) ranging between -0.05 and -0.2 (Section B.3.10.3 and Appendix Q). Overall, differing assumptions on utility values had a modest impact on the cost-effectiveness results (Section B.3.10.3 and Appendix Q).

B.3.4.5.4 Decrement in EQ-5D associated with each progression event for LGG (relative to the previous health state)

For the LGG analysis, the decrement in EQ-5D associated with each progression event was assumed to be -0.06 (95% CI: $-0.1, -0.02$) based on the change in EQ-5D reported in patients with malignant glioma at the time of disease progression (82). Due to the uncertainty, the decrement in EQ-5D associated with each recurrence was varied in a sensitivity analysis and had a modest impact on the cost-effectiveness results (Figure 38).

B.3.4.5.5 Decrement in EQ-5D for patients with malignant transformation treated with first line TMZ (relative to the previous health state)

A decrement of -0.06 was assumed for patients at the point of malignant transformation.

B.3.4.5.6 Decrement in EQ-5D for HGG receiving BSC/palliative care following progression or entry

Following progression or entry (for those starting on BSC), paediatric patients with HGG were assumed to receive palliative care with QoL progressively worsening. In TA121 (97), it was assumed that patients in the “progressive” state would experience a constant decline in their QoL, assuming a 0.5% reduction week on week. However, this value is not evidence based and was based on unsupported assumption (81). The base-case economic analysis used the weekly reduction in EQ-5D derived from Drewes et al (2018 (81).

Drewes 2018 (81) reported the EQ-5D 3L (UK value set) in adult patients with HGG (mean age: 63.9, n=96) at baseline (EQ-5D: 0.76 [$-0.48, 1.0$]) and at 6 month (EQ-5D: 0.38 [$-0.43, 1.0$]). However, the study reported that those who died were assigned a utility score of 0.0, and 21 patients were removed due to missing data. Based on the information from the study, the utility value at 6 months was estimated to be closer to 0.57 for those that are alive (compared with the 0.38 original value reported in the study that assigned 0.0 for patients who died), leading to a weekly reduction of 1.1%.

B.3.4.5.7 QALY Decrement associated with the mode of administration

The economic model included the benefits in terms of HRQoL associated with the availability of oral treatments over existing treatments, as highlighted by clinical and patient experts, and recognised in previous NICE guidelines (102) and appraisals (103). The QALY loss associated with IV treatment was obtained from a UK study that evaluated utility values for health states related to treatment mode of administration in Gaucher disease (104). Health state utilities were obtained using the time trade-off (TTO) method via face-to-face interviews with 100 members from the UK general population. The study reported a utility of 0.85 for the generic state for “oral treatment” vs 0.73 for the generic state for “IV treatment” (described as a 1- to 2-hour infusion every 2 weeks), equating to a reduction in utility of 0.12. As patients starting on IV chemotherapy (C+V) were treated for up to 81 weeks, the QALY loss associated with IV administration was estimated to be -0.187 .

Sensitivity analysis (Figure 38) were conducted assuming no decrement or using the value of –0.175 reported in Matza 2013 (105), estimated using a TTO approach among 121 members of the public for treatments for bone cancer. The impact on cost-effectiveness results was modest.

Table 45: Summary of utility values for cost-effectiveness analysis

State	Utility value: mean (SE)	95% CI	Reference in submission (section and page number)	Justification
Main health states – Common to all population				
Background EQ-5D	Figure 34	N/A	Section B.3.4.5.1	In line with NICE reference case (78)
Main health states – LGG analysis				
Decrements relative to patients without the condition				
LGG – model entry	–0.155	N/A	Section B.3.4.5.2	Derived from Drewes 2018 (81) and Vera 2023 (82)
Decrements relative to the previous health states				
First progression	–0.06 (95% CI –0.1; –0.02)		Section B.3.4.5.4 and B.3.4.5.5	Taken from the EQ-5D decrement associated with progression reported in Vera 2023 (82)
Second progression				
Third progression				
Fourth progression				
Fifth progression				
Malignant transformation (1L)				
QALY loss – one off at model entry for C+V				
Mode of administration (IV chemotherapy)	–0.187	N/A	Section B.3.4.5.7	
Main health states – HGG analysis				
Decrements relative to patients without the condition				
HGG relapsed/refractory	–0.155	N/A	Section B.3.4.5.3	Derived from Vera 2023 (82)
Weekly reduction in EQ-5D while in progressed disease health state				
Weekly reduction in HRQoL	1.10%	N/A	Section B.3.4.5.6	Derived from Drewes 2018 (81)

Abbreviations: 1L, first-line; C, carboplatin; CI, confidence interval; EQ-5D, EuroQol five-dimensions; HGG, high-grade glioma; HRQoL, health-related quality of life; IV, intravenous; LGG, low-grade glioma; N/A, not applicable; NICE, National Institute for Health and Care Excellence; QALY, quality adjusted life year; SE, standard error; V, vincristine.

B.3.5 Cost and healthcare resource use identification, measurement and valuation

Costs considered in the economic model included treatment costs (drug acquisition and administration), costs associated with the management of glioma/monitoring of treatments,

Dabrafenib with trametinib for treating *BRAF* V600E mutation-positive glioma in children and young people aged 1 to 17

subsequent treatment costs, costs associated with the management at the end of life, and the costs associated with the management of AEs.

B.3.5.1 Intervention and comparators' costs and resource use

Drug acquisition and administration costs for treatments included in this economic evaluation are summarised in Table 46 and Figure 35. D+T is administered continuously until progression (or per stopping rule described in Section B.3.2.8.1), with the dose and costs dependent on age/weight, capped at 300 mg daily dabrafenib and 2 mg daily trametinib. Chemotherapy consisting of C+V consist of a 24-week induction period, followed by ten 6-weekly maintenance cycles (at a total cost £24,582 including drug and administration for those completing treatment). The 4-weekly cost for daily TMZ was estimated to be £114.70.

B.3.5.1.1 Drug acquisition costs

The list price for treatments that are part of SoC/subsequent treatments were taken from the British National Formulary (BNF) (86) (Table 46), where appropriate. Since vincristine, carboplatin, vinblastine and temozolomide are available to the NHS as generic medicines, costs were calculated from the Electric Market Information Tool (eMIT) based on the number of prescriptions (87). The anticipated list price for dabrafenib (Finley®) and trametinib (Spexotras®) is not yet available on the BNF and is expected to be £■■■■ for dabrafenib (420 dispersible tablets of 10 mg) and £■■■ for trametinib (4.7 mg bottle). A patient access scheme (PAS) was submitted providing the NHS a discount of ■■■% off the anticipated list price for dabrafenib (Finley®) and ■■■% off the anticipated list price for trametinib (Spexotras®).

B.3.5.1.2 Dosing schedule assumed in the economic model

The dosing and administration schedules assumed for chemotherapy treatments included in the economic model are presented in Table 46 and Figure 35. These were based on the recommended dose and administration schedule for chemotherapies in the CCLG guideline (27), Verschuur 2004 (66), and clinical expert opinion (28, 29).

D+T is given daily, with the dose dependent on the age/weight of the patient in TADPOLE. To predict the dosage required as patients get older, regression models (with age in the log scale) were constructed (gender as covariate) using data from TADPOLE. Separate models were constructed for LGG and HGG and used in the base case. A model pooling data from both populations was explored in scenario analysis (Section B.3.10.3 and Appendix Q). Figure 29 presents a comparison of the observed dose by age and gender and predicted in the economic model. A scenario analysis was also presented whereby dose was predicted based on weight only in line with the anticipated licence, where weight is predicted based on age (Section B.3.10.3 and Appendix Q). The impact on results was modest.

Table 46: Summary of treatment costs used in the economic model

Chemotherapy combination		Schedule (source)	Dose (source)	Vial/pack concentration and volume	Number of tablets/vials	Cost per vial/pack - NHS list price (source)	Cost per vial/pack (PAS)
D+T	Dabrafenib	Daily until progression	Daily dose based on age and weight	10 mg	420	████████	██████
	Trametinib	Daily until progression	Daily dose based on age and weight	4.7 mg	1	████████	██████
C+V	Carboplatin	Induction: Weeks 1–24 Maintenance: 10 cycles (6-week duration)*	175 mg/m ²	600 mg	1	£21.32 (87)	N/A
	Vincristine		1.5 mg/m ²	2 mg	5	£41.69 (87)	N/A
Vinblastine	Vinblastine	Weekly for 70 weeks*	5 mg/m ²	10 mg	5	£83.59 (87)	N/A
B+I	Bevacizumab	Bi-weekly for 52 weeks*	10 mg/kg	400 mg	1	£810.10 (86)	N/A
	Irinotecan		125 mg/m ²	100 mg	1	£130.00 (86)	N/A
TPCV	Tioguanine	Eight cycles of 6 weeks duration*	30 mg/m ²	40 mg	25	£76.35 (86)	N/A
	Procarbazine		200 mg/m ²	50 mg	50	£503.61 (86)	N/A
	Lomustine		110 mg/m ²	40 mg	20	£780.82 (86)	N/A
	Vincristine		1.5 mg/m ²	2 mg	5	£41.69 (87)	N/A
TMZ	TMZ	Daily until progression	200 mg/m ²	100 mg	5	£45.51 (87)	N/A

*administration schedule presented in Figure 35.

Abbreviations: admin, administration; B+I, bevacizumab plus irinotecan; C, carboplatin; D, dabrafenib; eMIT, electronic market information tool; mg, milligram; N/A, not applicable; PAS, patient access scheme; SD, standard deviation; T, trametinib; TA, technology appraisal; TMZ, temozolomide; TPCV, tioguanine, procarbazine, lomustine, vincristine; V, vincristine.

Figure 36: Dose assumed in the economic model for D+T according to age and gender for LGG and HGG analysis

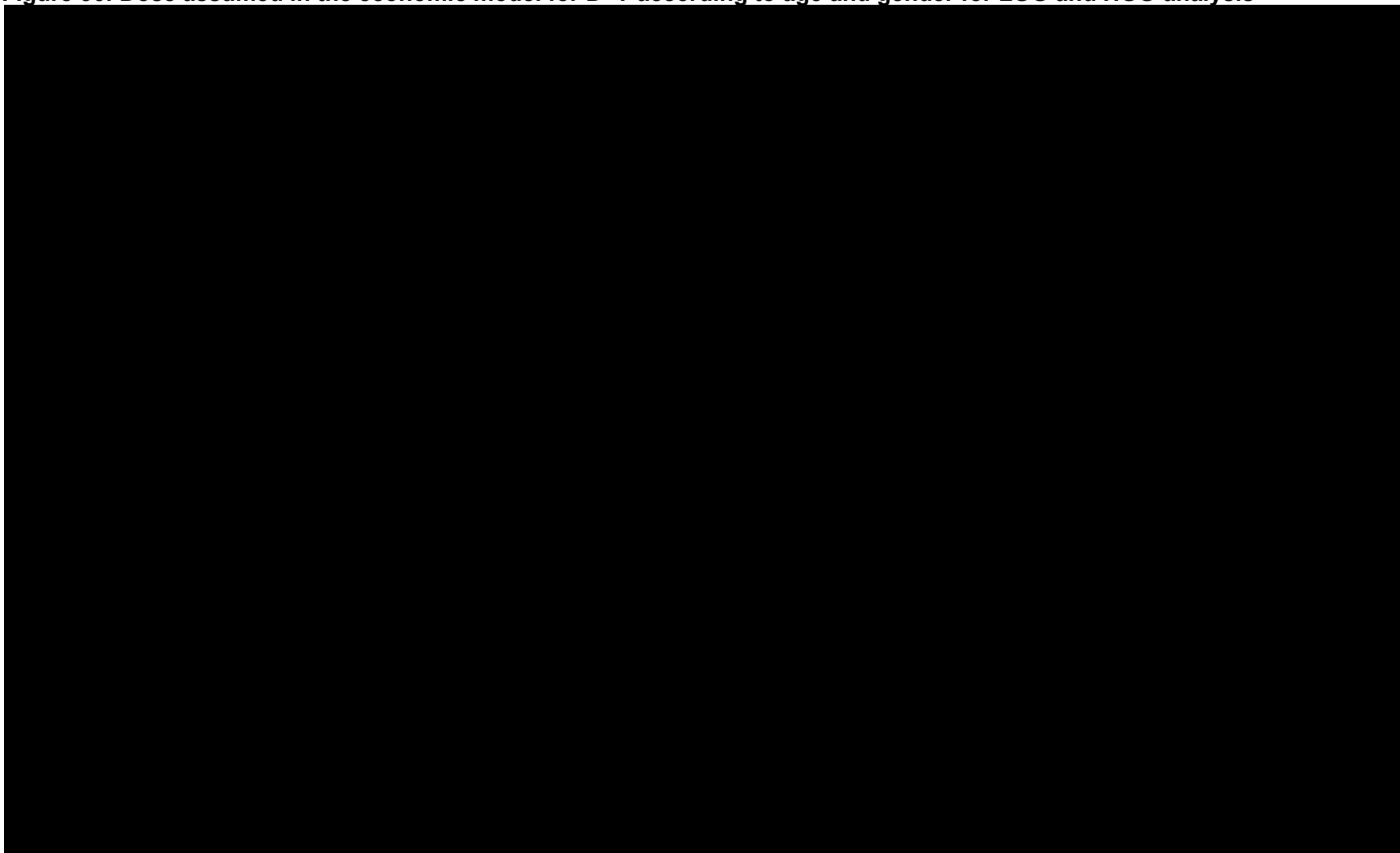

Source: Analysis of TADPOLE (39).

Abbreviations: D, dabrafenib; F, female; HGG, high-grade glioma; LGG, low-grade glioma; M, male; mg, milligram; predict, predicted.

B.3.5.1.3 Dose intensity/reduction

As the dose for D+T in the economic model in the base-case was derived from the dose given in the trial, dose intensity/reduction were implicitly accounted for. Dose intensity/reductions were included for C+V based on Gnekow 2017 (89) to reflect the differences in dosage between the US and European schedule. Gnekow 2017 reported a mean dose of 0.6 mg/m²/week for vincristine (Relative dose intensity [RDI]: 68.18%) and 124.2 mg/m²/week for carboplatin (RDI: 70.97%) against target doses of 0.88 mg/m²/week and 175 mg/m²/week, respectively. In TADPOLE, the RDI was higher for vincristine and carboplatin; █████% and █████% for induction and █████% and █████% in maintenance phase, respectively. A scenario analysis was conducted using the RDI from TADPOLE (Section B.3.10.3) (39). No dose intensity/reduction was assumed for TMZ in the absence of data, and no dose intensity/reduction was also assumed for subsequent treatments for simplicity.

B.3.5.1.4 Drug administration costs

Drug administration costs are summarised in Table 47. Intravenous chemotherapies (C+V, vinblastine, bevacizumab plus irinotecan, and TPCV) were assumed to be given as a day-case with the costs taken from the NHS reference costs 2021/2022 (84). The national cost collection guidance states that in the NHS reference cost, the delivery of chemotherapy in day case are recorded using a core health resource group (HRG) (zero cost) and two unbundled chemotherapy HRGs categories related to 1) HRGs for procurement of chemotherapy regimens according to cost band, and 2) HRGs for the delivery of chemotherapy regimens (106). For combination chemotherapies (C+V, bevacizumab plus irinotecan, and TPCV), the cost for the delivery of complex chemotherapy at first attendance was used (SB14Z) at the start of the chemotherapy cycle, followed by the cost for the delivery of subsequent elements of a chemotherapy cycle (SB15Z). For individual chemotherapy regimen (vinblastine), the cost associated with simple parental administration was assumed (SB12Z). The cost associated with procurement of chemotherapy (which covers all costs associated with procuring each drug cycle, including supportive drugs and pharmacy costs [indirect and overheads]) was considered based on regimens in Band 6 (SB06Z). D+T and TMZ are oral treatments; therefore, no administration cost was assumed.

Table 47: Drug administration costs

HRG	Setting	Description	Unit cost (£)	Source
SB12Z	Day case	Deliver Simple Parenteral Chemotherapy at First Attendance	£313.91	NHS reference cost 2021/2022 (84)
SB14Z	Day case	Deliver Complex Chemotherapy, including Prolonged Infusional Treatment, at First Attendance	£485.23	NHS reference cost 2021/2022 (84)
SB15Z	Day case	Deliver Subsequent Elements of a Chemotherapy Cycle	£383.54	NHS reference cost 2021/2022 (84)
SB06Z	Day case	Procure Chemotherapy Drugs for Regimens in Band 6	£349.40	NHS reference cost 2021/2022 (84)

Source: NHS reference cost (84).

Abbreviations: HRG, healthcare resource group; NHS, National Health Service.

B.3.5.2 Healthcare resource use and costs

An SLR was conducted to identify healthcare resource use (HCRU) and cost data relevant to the decision problem from the published literature as summarised in Appendix I. In total, 21 studies were identified that met the pre-defined inclusion criteria (14 full-text publications, five conference abstracts, and two conference posters). Of these, one study (a conference abstract) included data from UK patients.

B.3.5.2.1 Frequency of visits

The frequency of monitoring assumed in the economic model for C+V, D+T, and TMZ was derived from the frequency of visits reported for C+V in the CCLG guideline (27) and clinical opinion and are summarised in Table 48. Unit costs were derived from the NHS reference costs 2021/2022 (84) and Personal Social Services Research Unit (PSSRU) (85) published costs and are presented in Table 48.

Table 48: Unit costs

Item	Unit cost	Source
Clinical examination	£316.49	NHS reference costs 2021/2022 (84): WF01A (Consultant led), Non-Admitted Face-to-Face Attendance, Follow-up
Blood test	£2.39	NHS reference costs 2021/2022 (84): DAPS03 (Integrated blood services)
Coagulation	£3.35	NHS reference costs 2021/2022 (84): DAPS09 (Others)
Ophthalmological assessment	£130.65	NHS reference costs 2021/2022 (84). Weighted average (WF01A-WF02C) (consultant led): Paediatric Ophthalmology Service
GFR	£688.89	NHS reference costs 2021/2022 (84): RN27B-C: Glomerular Filtration Rate Testing
PTA	£390.41	NHS reference costs 2021/2022 (84): WF01A (consultant led): Paediatric Audio Vestibular Medicine Service; Non-Admitted Face-to-Face Attendance, Follow-up
MRI	£222.16	NHS reference cost 2021/2022 (84): weighted average (RD01B, RD01C, RD02B): Magnetic Resonance Imaging
Echo	£69.90	NHS reference cost 2021/2022 (84) - EY50Z - Complex Echocardiogram
ECG	£74.91	NHS reference cost 2021/2022 (84) - EY51Z - Electrocardiogram Monitoring or Stress Testing

Source: taken from NHS reference costs (84).

Abbreviations: ECG, electrocardiogram; GFR, glomerular filtration rate; MRI, magnetic resonance imaging; NHS, National Health Service; PTA, pure-tone average.

Clinical experts indicated that monitoring is more frequent with chemotherapies and that ophthalmological and auditory assessment and glomerular filtration rate (GFR) are specific to the monitoring for C+V and not required for D+T (28, 29). However, clinical experts indicated that patients on D+T would require an electrocardiogram (ECG) and echocardiogram monitoring.

Monitoring for other chemotherapies (vinblastine, bevacizumab plus irinotecan and TPCV) was included during the treatment period only for simplicity, and derived from the frequency of visits reported in the CCLG guideline (Table 49) (27).

Dabrafenib with trametinib for treating *BRAF* V600E mutation-positive glioma in children and young people aged 1 to 17

Table 49: On treatment monitoring assumed in the economic model.

Investigation	During chemotherapy treatment period (e.g. up to Week 84)			After 2 years	
	C+V	D+T	TMZ	3 rd –5 th year	6 th –10 th year
History, (including height & weight) clinical examination incorporating neurological assessment.	Every 3 weeks (Week 1–24) Every 6 weeks (Week 25–84)	Every 4 weeks (Week 1–24) Every 8 weeks (Week 25–84)		Every 6 months	Annually
Full blood count and differential, serum urea, creatinine, electrolytes, Mg ⁺⁺ , Ca ⁺⁺ , ALT/AST, bilirubin					
Ophthalmological assessment	Week 12, 24, 36, 48, 60, 72 and 84	–	–	–	–
GFR, as measured by serum creatinine or 51-Cr-EDTA clearance	Week 24, 54 and 84	–	–	–	–
Audiology assessment (PTA if over three years; OAE if under three years) every six months		–	–	–	–
Contrast-enhanced MRI scan of affected CNS site (brain, spine, both)		–	–	–	–
ECG	–	Week 12, 24, 36, 48, 60, 72 and 84 [‡]		–	–
Echocardiogram	–			–	–

Source: Derived from CCLG guideline (27)

[‡]not for TMZ

Abbreviations: 51-Cr-EDTA :chromium-51 ethylenediamine tetra-acetic acid; ALT, Alanine transaminase; AST, aspartate aminotransferase; Ca⁺⁺, serum calcium; CNS, central nervous system; GFR, glomerular filtration rate; HRG, healthcare resource group; Mg⁺⁺, magnesium ion; MRI, magnetic resonance imaging; NHS, National Health Service; OAE, Otoacoustic Emissions; PTA, pure-tone average.

B.3.5.2.2 Subsequent treatments assumed for the LGG subgroup.

To capture the costs associated with subsequent treatments following progression, the economic model used the distribution of treatment modalities (surgery, chemotherapy, radiotherapy) (Table 50), reported in Kandels 2020 (79). To avoid overcomplicating the model, costs are applied as a one off at the time of progression. This was considered a pragmatic decision given chemotherapies for subsequent lines are given for a fixed duration, typically a year, as per CCLG guidelines.

Table 50: Treatment modalities given following progression[†]

	Surgery	PBT/ Radiotherapy	Chemotherapy	Cost following progression
First progression	11.3%	25.3%	51.0%	£26,107
Second progression	11.6%	22.1%	57.0%	£29,497
Third progression	5.4%	12.5%	37.5%	£10,329
Fourth progression	20.0%	20.0%	100.0%	£22,950

Source: Derived from Kandels 2020 (79), NHS reference cost (84) and DoH (107).

[†]does not add up to 100% as patients can receive more than one treatment or no treatment.

Abbreviations: DoH, Department of Health; NHS, National Health Service; PBT, proton beam therapy.

The costs associated with a course of chemotherapy was derived from the administration schedule in Figure 35, respective drug and administration unit costs and time to progression for subsequent line of treatment (Section B.3.3.5).

The cost associated with surgeries was obtained from the NHS reference cost 2021/22 (84) (Weighted average of intracranial procedures; Healthcare Resource Group [HRG]: AA50D-AA57C).

In line with the NHS clinical commissioning policy (108), proton beam therapy (PBT) was assumed in the model instead of conventional radiotherapy due to the severe or life-threatening complications associated with conventional radiotherapy. The cost for PBT was taken a report by the Department of health for the National Proton Beam Therapy Service Development Programme (107).

B.3.5.2.3 Management costs associated with malignant transformation (first-line)

Simplifications were made as malignant transformation events are rare and therefore, were unlikely to have an impact on the cost-effectiveness results. At the time of transformation, patients were assumed to incur a one-off cost of £16,293, reflecting the cost associated with adjuvant TMZ plus radiotherapy and carmustine implants taken from the cost reported in the Scottish Medicines Consortium assessment (109). Sensitivity analyses were conducted varying the cost $\pm 20\%$ (Section B.3.10.3) and confirmed the little impact on the incremental cost-effectiveness ratio (ICER).

B.3.5.2.4 Management costs for paediatric patients with HGG receiving BSC/palliative care

Best supportive care management is multi-disciplinary and varied, and involves medical clinicians, specialist nurses, nurse practitioners, occupational therapists, physiotherapists, exercise physiologists, psychologists, social workers, speech pathologists, dietitians, GPs and community nurses and other allied services.

A 4-weekly cost of £1,100 was assumed for patients receiving palliative care/BSC based on the assumption that patients require one outpatient visit, one non-medical specialist palliative care visit (encompassing referral to a mix of allied services) and two specialist nurse visits every 4 weeks.

- Clinical experts noted that there is variation in resource use for patients requiring BSC, with some patients needing to be seen twice a week as they need symptom management while some without symptoms may be reviewed every 3 months (28, 29). The clinical expert indicated that they would usually offer to see patient once monthly (often with a nurse) with the option for patients to have more frequent visit if needed. Clinical expert further noted that patients would also have specialist nurse visits, with the frequency ranging from twice a week toward the end of the life to monthly or depending on when needed.
- Furthermore, results from a UK survey on follow-up practices for HGG conducted amongst 86 clinicians found that respondents reported patients having referral access to neurologists, physiotherapy, speech therapy, clinical trials, epilepsy nurse, social worker, counsellor, neuro-psychologist, support group, rehabilitation, occupational therapy, clinical psychology, or complementary therapies (110). Due to the varied nature of referral, for simplicity, the cost of one non-medical specialist palliative care attendance was assumed per month and assumed to reflect referrals made to allied services.

Table 51: Unit costs used for BSC

Item	Unit cost	Source
Multi-professional visit	£372.30	NHS reference costs 2021/2022 (84): Consultant Led (WF02A) - Paediatric Medical Oncology Service: Multi-professional Non-Admitted Face-to-Face Attendance, Follow-up
Nurse specialist	£66.66	NHS reference costs 2021/2022 (84): HRG: N10CF: Specialist Nursing, Cancer Related, Child, Face to face
Non-medical specialist palliative care attendance	£594.21	NHS reference costs 2021/2022 (84): HRG: SD05B: Non-Medical Specialist Palliative Care Attendance, 18 years and under

Due to the uncertainty, sensitivity analyses are conducted varying the cost $\pm 20\%$ and show limited impact on results (Section B.3.10.3).

B.3.5.2.5 Cost associated with terminal care

A one-off cost of £8,369 for terminal/palliative care was applied within the model at the point of death taken from the per-patient estimated cost for health and social care in the last three months of life diagnosed with cancer reported in research report by the Nuffield trust (111), and inflated to 2022 costs using the PSSRU inflation indices (85).

B.3.5.3 Adverse reaction unit costs and resource use

Costs associated with the management of Grade 3 and 4 AEs (Table 52) were sourced from the NHS reference costs 2021/22 (84).

Table 52: Adverse events costs

AEs	Unit cost	Source
Neutrophil count decreased	£3,062	NHS Reference cost 2021/2022 (84): Paediatric, Hepatobiliary or Pancreatic Disorders (PG71A)
White blood cell count decreased	£3,062	
Alanine aminotransferase increased	£3,062	
Lymphocyte count decreased	£3,062	
Platelet count decreased	£3,062	
Blood creatine phosphokinase increased	£3,062	
Gamma-	£3,062	
Hypomagnesaemia	£3,062	
Aspartate	£3,062	
Ejection fraction	£3,062	
Amylase increased	£3,062	
Lipase increased	£3,062	
Hypersensitivity	£1,476	
Abdominal infection	£1,476	
Device related infection	£1,476	
Infusion related reaction	£1,476	
Viral infection	£1,476	NHS Reference cost 2021/2022 (84): Paediatric, Rash or Other Non-Specific Skin Eruption (PJ66A)
Rash	£704	
Urticaria	£704	
Flushing	£704	NHS Reference cost 2021/2022 (84): Hypertension (EB04Z)
Hypertension	£770	
Hypotension	£770	NHS Reference cost 2021/2022 (84): Paediatric, Headaches or Migraines (PR04A)
Headache	£1,116	
Dizziness	£1,116	NHS Reference cost 2021/2022 (84): Paediatric Other Gastrointestinal Disorders (PF26A)
Gastrointestinal	£1,542	
Diarrhoea	£1,542	NHS Reference cost 2021/2022 (84): Paediatric Behavioural Disorders (PT52A)
Agitation	£2,200	
Confusional state	£2,200	

AEs	Unit cost	Source
Peripheral motor	£861	NHS Reference cost 2021/2022 (84): Paediatric Abdominal Pain (PX29A)
Peripheral sensory	£861	
Uterine haemorrhage	£861	
Anaemia	£1,519	NHS Reference cost 2021/2022 (84): Haemolytic Anaemia (SA03G)
Neutropenia	£10,303	NHS Reference cost 2021/2022 (84): Paediatric Febrile Neutropenia with Malignancy (PM45A)
Thrombocytopenia	£993	NHS Reference cost 2021/2022 (84): Thrombocytopenia (SA12G)
Pyrexia	£1,116	NHS Reference cost 2021/2022 (84): Paediatric, Headaches or Migraines (PR04A)
Weight increased	£740	NHS Reference cost 2021/2022 (84): Paediatric Metabolic Disorders (PK72A)
Uveitis	£1,375	NHS Reference cost 2021/2022 (84): Paediatric Non-Surgical Ophthalmology (PP64A)
Vomiting	£1,480	NHS Reference cost 2021/2022 (84): Paediatric, Feeding Difficulties or Vomiting (PF28A)
Pancreatitis	£3,062	NHS Reference cost 2021/2022 (84): Paediatric, Hepatobiliary or Pancreatic Disorders (PG71A)
Influenza like illness	£1,431	NHS Reference cost 2021/2022 (84): Paediatric Fever of Unknown Origin (PW20A)
Brain oedema	£978	NHS Reference cost 2021/2022 (84): Paediatric, Head, Neck or Ear Disorders (PC63A)

Source: Derived from NHS reference cost (84).

Abbreviations: AE, adverse event; NHS, National Health Service.

For C+V (LGG analysis) and TMZ (HGG analysis), a one-off cost was applied at model entry for simplicity, as most AEs were likely to have been captured within the study period. This was calculated by multiplying the frequency of AEs reported in Table 44 by the respective unit costs associated with the management of these AEs (Table 52), leading to a one-off cost of £6,744 for C+V and £4,519 for TMZ.

For D+T however, treatment duration could be extrapolated beyond that observed in the trial. Consequently, the incidence of AEs for D+T was adjusted for exposure and applied in the model during the duration of treatment. An annual cost of £1,486 was estimated based on the prevalence of AE, exposure duration and respective unit costs (Table 52).

Scenario analyses were conducted removing the impact of AEs on costs and QoL. As expected, the impact on the cost-effectiveness results was modest (Section B.3.10.3 and Appendix Q).

B.3.6 Severity

Due to the severity of the disease, paediatric patients suffering from glioma experience a substantial QALY shortfall, compared with the general population. This is illustrated by the QALY shortfall calculations, as presented in Table 53, with the features of this analysis presented in Table 53 and Table 54. It should be noted that the age and gender distribution from TADPOLE was used (Section B.3.3.1), rather than the mean. The total life expectancy for the modelled population was calculated using population mortality data from the ONS Dabrafenib with trametinib for treating *BRAF* V600E mutation-positive glioma in children and young people aged 1 to 17

report for 2018–2020 (91). The total life expectancy was quality-adjusted using UK population norm values for EQ-5D by age and sex as reported by Hernández Alava 2023 (83).

Discounted QALYs for patients with and without the glioma were taken directly from the economic model. The absolute shortfall for the LGG and HGG cohorts were over 12 and over 23 respectively, justifying a 1.2x and 1.7x QALY weight.

Table 53: Summary of QALY shortfall analysis

Analysis	Expected total QALYs for the general population	Total QALYs that people living with a condition would be expected to have with current treatment	Absolute QALY shortfall	Proportional QALY Shortfall
LGG	24.12	11.39	12.73	52.8%
HGG – No prior TMZ	23.81	0.73	23.08	96.9%
HGG – prior TMZ	23.81	0.43	23.38	98.2%

Abbreviations: HGG, high-grade glioma; LGG, low-grade glioma; QALY, quality-adjusted life year; TMZ, temozolomide.

Table 54: Summary features of QALY shortfall analysis

Factor	Value (reference to appropriate table or figure in submission)	Reference to section in submission
Sex distribution	60% male (gender distribution used in the model). Please refer to Figure 20	Section B.3.3.1
Starting age		

Abbreviations: QALY, quality-adjusted life year.

Table 55: Summary of health state benefits for QALY shortfall analysis

State	Utility value: mean (standard error)	Undiscounted life years - LGG	Undiscounted life years – HGG (no prior TMZ)	Undiscounted life years – HGG (prior TMZ)
Progression-free	Table 45	19.98 (D+T)	4.95 (D+T)	1.91 (D+T)
	Table 45	15 (comp)	0.38 (comp)	0 (comp)
Progression	Table 45	37.81 (D+T)	0.86 (D+T)	0.86 (D+T)
	Table 45	32.52 (comp)	0.90 (comp)	0.90 (comp)

Abbreviations: C, carboplatin; comp, comparator; D, dabrafenib; HGG, high-grade glioma; LGG, low-grade glioma; QALY, quality-adjusted life year; T, trametinib; TMZ, temozolomide; V, vincristine.

B.3.7 Uncertainty

Despite gliomas being a rare condition, dabrafenib (Finley®) and trametinib (Spexotras®) were specifically developed for paediatric patients with glioma as young children are unable to swallow tablets/capsules and may improve tolerability amongst older children. This indication did not meet the criteria for an evaluation under the highly specialised technology (HST) route due to D+T being recommended in other indications (as hard capsules). As paediatric glioma is a rare disease, this evaluation suffers from evidence constraints and challenges associated with small population numbers and the target population. As such, flexibility in decision making should be considered by the committee. Such a situation is Dabrafenib with trametinib for treating *BRAF* V600E mutation-positive glioma in children and young people aged 1 to 17

recognised in the NICE method guide, which states flexibility is allowed in cases where it is particularly difficult to generate enough evidence such as children or rare diseases, both apply here. HGG in particular, is associated with a very poor prognosis with limited treatment options. It is therefore challenging to conduct a randomised controlled trial for such a population, particularly for a paediatric age group. Despite the rarity and mutation, the evidence for this submission has been derived from a well-designed Phase 2 trial which has considered all these challenges in its execution. Without flexibility offered by the process, paediatric patients with glioma may be disadvantaged.

To prevent inequality for paediatric patients suffering from a rare condition with significant unmet need, we urge the committee to exercise flexibility and evaluate the cost-effectiveness of D+T against the upper end of current WTP thresholds and consider further flexibility as afforded under the HST route.

B.3.8 Summary of base-case analysis inputs and assumptions

B.3.8.1 Summary of base-case analysis inputs

A summary of the base-case model inputs is provided in Table 56.

Table 56: Summary of variables applied in the economic model.

Variable	Value	Measurement of uncertainty and distribution: CI (distribution)	Reference to section in submission
NICE reference case			
Time horizon	Lifetime	Not varied	Section B.3.2.7
Discount rate for costs	3.5%	1.5–6.0%	Section B.3.2.7
Discount rate for benefits	3.5%	1.5–6.0%	Section B.3.2.7
Baseline characteristics			
Age	Figure 20	Dirichlet	Section B.3.3.1
% male (male %)	Figure 20	Multivariate normal	Section B.3.3.1
Weight	Table 41	Normal	Section B.3.3.1
HRQoL			
Baseline EQ-5D (patients without the condition)	Figure 34	Not varied	Section B.3.4.5.1
Decrement LGG at entry	–0.155	Beta [†]	Section B.3.4.5.2
Decrement progression (for each subsequent progression)	–0.06	Beta [†]	Section B.3.4.5.4
Decrement malignant transformation	–0.06	Beta [†]	Section B.3.4.5.5
Decrement HGG at entry	–0.155	Beta [†]	Section B.3.4.5.6
Weekly reduction in HRQoL	1.10%	Beta [†]	Section B.3.4.5.6
QALY loss IV	–0.187	Beta [†]	Section B.3.4.5.7
Drug (administration) costs assumptions			
Dosage for D+T	Figure 36 and Table 46	Multivariate normal	Section B.3.5.1.2
Schedule for C+V	Table 46 and Figure 35	Not varied	
Schedule for TMZ	Table 46 and Figure 35	Not varied	
Schedule for Vinblastine	Table 46 and Figure 35	Not varied	
Schedule for B+I	Table 46 and Figure 35	Not varied	
Schedule for TPCV	Table 46 and Figure 35	Not varied	
Monitoring			
Monitoring	Table 49	Not varied	Section 0

Variable	Value	Measurement of uncertainty and distribution: CI (distribution)	Reference to section in submission
Subsequent treatment cost distribution (LGG analysis)	Table 50	Beta	Section B.3.5.2.2
Unit costs			
Proton beam therapy	£39,450.00	Gamma [†]	Section B.3.5.2.2
Surgery	£11,662.50	Gamma [†]	
Simple administration	£313.90	Gamma [†]	Section B.3.5.1.4
Complex administration	£485.20	Gamma [†]	
Subsequent administration	£383.50	Gamma [†]	
Procurement cost per cycle	£349.40	Gamma [†]	
Clinical examination	£316.50	Gamma [†]	Section 0
Blood test	£2.40	Gamma [†]	
coagulation	£3.30	Gamma [†]	
Ophthalmological assessment	£130.70	Gamma [†]	
GFR	£688.90	Gamma [†]	
PTA	£390.40	Gamma [†]	
MRI	£222.20	Gamma [†]	
ECG	£69.90	Gamma [†]	
Echocardiogram	£74.90	Gamma [†]	
Non-medical palliative care	£594.20	Gamma [†]	
Specialist nurse	£66.70	Gamma [†]	
Multi-professional visit	£372.30	Gamma [†]	
Management costs for adverse events			
D+T	£1,486 per year	Gamma [†]	Section B.3.5.3
C+V	£6,744 (one off)	Gamma [†]	
TMZ	£4,519 (one off)	Gamma [†]	
Other costs			
End of life	£8,369	Gamma [†]	Section B.3.5.2.5

[†]SE assumed to be 10%.

Abbreviations: B, bevacizumab; C, carboplatin; CFB, change from baseline; CI, confidence interval; D, dabrafenib; GFR, glomerular filtration rate; HGG, high-grade glioma; HR, hazard ratio; HRQoL, health-related quality of life; I, irinotecan; IV, intravenous; LGG, low-grade glioma; MRI, magnetic resonance imaging; NICE, National Institute for Health and Care Excellence; PFS, progression-free survival; QALY, quality-adjusted life year; OS, overall survival; PTA, pure-tone average; SE, standard error; SoC, standard-of-care; T, trametinib; TMZ, temozolomide; TPCV, tioguanine, procarbazine, lomustine, vincristine; TTD, time-to-treatment discontinuation; V, vincristine.

B.3.8.2 Assumptions

The assumptions used in the base-case analysis are described in Table 57, with a description of the scenarios conducted to explore the potential impact of these assumptions, where appropriate.

Table 57: List of assumptions for the base-case analysis model

Assumption	Description of assumption for the base case	Justification	Addressed in scenario analysis
Population			
Analyses for paediatric LGG and HGG are presented separately	Separate analyses are presented for these two populations (licensed population) as described in the NICE final scope (26)	As the population included in TADPOLE comprises two mutually exclusive sub-populations (LGG and HGG), separate analyses are presented as described in the NICE final scope (26)	N/A
HGG analyses	Separate analyses are conducted for HGG according to receipt of prior TMZ	Clinical experts (28, 29) indicated that in patients previously treated with TMZ, BSC is the most relevant comparator	An analysis was conducted using data irrespective of TMZ treatment
The patient population of TADPOLE is generalisable to England and Wales	Baseline characteristics (age, gender, weight) of patients who would receive D+T in clinical practice is reflective of those included in the TADPOLE trial	Clinical experts deemed the trial to be representative of UK practice (28, 29)	Scenario analyses were conducted using the age and gender distribution in Kandels 2020 (79)
<i>BRAF</i> V600E not a prognostic factor for PFS or time to death following progression	Data/evidence from molecularly unselected patients are used	Due to the rarity of the condition and mutation, there are no data available in patients with a <i>BRAF</i> V600E mutation. While there are no data to assess the prognostic value of <i>BRAF</i> V600E in paediatric patients with HGG that are relapsed/refractory, evidence in first line suggest that this is a reasonable assumption for PFS. Clinical experts further indicated that the prognostic for patients with HGG relapsed/ refractory is very poor and using data from molecularly unselected patients was reasonable (28, 29) Clinical experts further indicated that it was reasonable to use data from molecularly unselected patients as	Scenario analyses were conducted, reducing the rate of death following progression for LGG

Assumption	Description of assumption for the base case	Justification	Addressed in scenario analysis
		a proxy for the time to death following progression for the LGG analysis	
Comparators & intervention			
The comparator in the economic case for the LGG analysis is C+V (European schedule)	Costs according to the European schedule are used in the economic model	C+V is the SoC in the UK in first line as per the CCLG guideline (European schedule) (27). C+V was the comparator in the TADPOLE trial but was given according to the US schedule. Clinical experts explained that both schedules are equivalent (28, 29). Using the European schedule reflect cost incurred in the NHS, which is line with the NICE reference case (78)	N/A
The comparator in the economic case for the HGG analysis are TMZ and BSC	The following comparators are assumed: <ul style="list-style-type: none"> • TMZ in patients not previously treated with TMZ • BSC in patients previously treated with TMZ 	There are no accepted SoC for paediatric patients with patients that are relapsed/refractory (28, 29). Clinical experts noted that TMZ was the most likely chemotherapy, but that most patients tend to receive TMZ in first-line. Following TMZ failure, clinical experts explained that options are very limited, and BSC/palliative care was the key comparator	N/A
Dosage for D+T based on TADPOLE	In TADPOLE dosage was based on age and weight. The dosage in the license is simplified based on weight only	Dosage from TADPOLE is used in the base-case to align cost and efficacy	A scenario analysis was conducted costing D+T based on weight only
Modelling structure/approach			
State-transition approach is used with OS estimated indirectly using surrogacy	OS is modelled as a function of the first progression. For LGG, the time to death following progression was assumed to be different between those with early (<18 months) and late (≥18 months) progression. For HGG (no prior TMZ comparison), the same time to death is assumed based on that from the TADPOLE study	This is because of the immaturity of the OS for LGG in the TADPOLE trial due to the indolent nature of LGG. For HGG this approach reduces potential biases in comparing OS from different studies for HGG due to potential differences in salvage treatments given post-progression and population (<i>BRAF</i> V600E vs. molecularly unselected). For LGG, evidence suggests that early and late progressor have a different prognosis	Time to death following post progression from Gnekow 2017 (89) was used in scenario analysis for LGG

Assumption	Description of assumption for the base case	Justification	Addressed in scenario analysis
An individual approach is used	Time to events is sampled	An individual based model was chosen for increased flexibility (avoid tunnels states) and to reflect the dosage for D+T beyond the trial duration that is based on weight, reflect the license for D+T that is restricted to patients aged 1 to 17 years old, reflect the expected discontinuation of D+T in UK clinical practice as patients get older and/or remain progression-free and model the progressive worsening in HRQoL for patients with HGG on BSC/palliative care	N/A
Same PPS assumed for HGG	PPS estimated from TADPOLE applied to both D+T and comparators for HGG	Assuming the same PPS mitigate some of the uncertainties of using data from different studies conducted in different population, with potentially different salvage treatment given post-progression There is a lack of data on OS for BSC. Clinical experts indicated that there is no effective treatment available for these patients. Clinical experts further indicated that they expect the survival for patients on BSC to be between 3-6 months, in line with survival reported in the studies and PPS	Alternative sources were used
Treatment effect and treatment effect waning			
Treatment effect waning included	No treatment effect included in the base-case beyond the KM (observed data). The treatment effect is lost upon treatment discontinuation	In the base case, no treatment effect is assumed, and the same rate of progression is assumed in both arms beyond the KM	In the scenario analysis where treatment is given beyond the KM, a treatment effect was applied only until patients remain on treatment, with no treatment effect assumed when patient discontinue D+T

Assumption	Description of assumption for the base case	Justification	Addressed in scenario analysis
Selection of parametric functions from TADPOLE			
PFS for C+V and D+T for LGG	KM (Year 0– next to last observed event), Log-normal (next to last observed event – onward), followed by no progression when patient reach adulthood (assumed to be 25 years of age)	The KM was selected due to poor parametric fit to the KM. The log-normal was selected following (1) visual fit, (2) statistical goodness of fit and (3) long-term plausibility. No progression was assumed after the age of 25 years to reflect the low likelihood of progression as patient reach adulthood as indicated by clinical experts	Alternative distributions and extrapolation methods were used in scenario analysis
PPS for HGG	Exponential used in the base case	Selected following (1) visual fit, (2) statistical goodness of fit and (3) long-term plausibility (93)	
TTD for D+T	Exponential used in the base case	Selected following (1) visual fit, (2) statistical goodness of fit and (3) long-term plausibility (93)	
Time to death following progression for LGG			
Time to death following progression for the LGG analysis	Piecewise exponential is used. Time to death assumed to depend on timing of progression: early (<18 months) vs late (≥18 months) progression	Kandels 2020 reported the survival at 5 and 10 years in those who progressed following first line treatment <18 months and ≥18 months (79)	A scenario analysis was conducted using the time to death following progression derived from Gnekow 2018 (89) or assuming a reduced rate of death
Subsequent progression for LGG			
The impact of subsequent progression is included for costs and QoL only	Patients with LGG can experience multiple progression, which impact both costs and quality of life. This is captured in the model. However, OS is not linked to further progression	Evidence for the survival following progression is taken from Kandels 2020 in patients treated with first-line at the time of their first progression (79).	A scenario analysis was conducted excluding subsequent progression

Assumption	Description of assumption for the base case	Justification	Addressed in scenario analysis
Malignant transformation for LGG			
1L following malignant transformation	Weibull used in the base case	Selected following (1) visual fit, (2) statistical goodness of fit and (3) long-term plausibility (93)	Alternative distributions were used in scenario analysis
No transformation assumed after 15 years	The inclusion of malignant transformation was simplified and only assumed to occur the first 15 years	Malignant transformations are rare. The incidence rate is taken from Kandels 2020 (79) and assumed to be stop after 15 years in the base case	Scenario analyses were conducted varying the maximum time of malignant transformation
HRQoL			
EQ-5D decrements	EQ-5D decrements from studies conducted in adults are used	The EQ-5D was not collected in the trial as this instrument is not recommended in patients aged less than 16 years old. While patients enter the model at younger age and instruments are available for children such as the HUI, patients will move to older ages, notably for the LGG cohort. Using different instruments between younger and older ages is likely to introduce challenges. Consequently, in line with the NICE reference case, EQ-5D is used across ages, with utility data for the health states taken from the published literature in adults (81, 82)	Scenario analyses were conducted varying utility values
IV QALY loss	A decrement in HRQoL is assumed for IV treatment (vs oral) (104)	Dabrafenib and trametinib are oral therapies and can be taken at home, and therefore represent a more convenient, less painful, and less burdensome method of administration compared with chemotherapy which must be administered via IV infusion and requires a patient to visit a hospital to receive treatment	Sensitivity analysis were conducted assuming no QALY loss or alternative values
Adverse events			
Adverse events	The effect of Grade 3/4 AEs on costs and HRQoL is included	The impact of AE on costs and quality of life is included in the base-case to reflect the NICE reference case (78)	A scenario analysis was conducted removing the effect of AEs

Assumption	Description of assumption for the base case	Justification	Addressed in scenario analysis
Resource use			
Subsequent treatments for LGG	Patients are able to receive up to 5 lines of treatment	The distribution of treatment is taken from Kandels 2020 (79)	Costs were varied in sensitivity analysis
Resource estimates for palliative care	Assumption of one outpatient visit, 2 specialist nurse and one non-medical palliative care visit a month	The management of patients on BSC is multidisciplinary and varied	Costs were varied in sensitivity analysis

Abbreviations: AE, adverse event; BNF, British National Formulary; BRAF, v-raf murine sarcoma viral oncogene homolog B; C, carboplatin; CCLG, Children's Cancer and Leukaemia group; D, dabrafenib; eMIT, electronic market information tool; HGG, high-grade glioma; HR, hazard ratio; HRQoL, health-related quality of life; IPD, individual patient data; LGG, low-grade glioma; N/A, not applicable; NHS, National Health Service; NICE, National Institute for Health and Care Excellence; QALY, quality-adjusted life year; OS, overall survival; PFS, progression-free survival; PPS, post-progression survival; PSM, partitioned survival model; PSS, Personal Social Services; SE, standard error; SmPC, summary of product characteristics; STM, state-transition model; T, trametinib; TTD, time-to-treatment discontinuation; V, vincristine.

B.3.9 Base-case results

In line with the NICE method guide, base-case results are presented excluding and including the disease severity modifiers. Results are further presented using the PAS price only.

B.3.9.1 Base-case incremental cost-effectiveness analysis results

Table 58 presents the base-case results of the economic evaluation for the LGG and HGG cohorts. Clinical outcomes from the cost-effectiveness model, the proportion of the cohort in each health state over time (Markov trace), and the disaggregated results of the base-case incremental cost-effectiveness analysis are reported in Appendix J. The net health benefit is presented in Table 59.

Table 58: Base-case incremental cost-effectiveness results (PAS price)

Technologies	Total costs (£)	Total LYG [†]	Total QALYs	Incr. costs (£)	Incr. LYG [†]	Excluding disease severity modifier		Including disease severity modifier	
						Incr. QALYs	ICER (£/QALY)	Incr. QALYs	ICER (£/QALY)
LGG cohort									
SoC (C+V)	£88,450	47.52	11.39	–	–	–	–	–	–
D+T	████████	57.79	████████	████████	10.27	████████	£31,102	████████	£25,918
HGG cohort - No prior TMZ									
SoC (TMZ)	£27,339	1.28	0.73	–	–	–	–	–	–
D+T	████████	5.81	████████	████████	4.53	████████	£48,660	████████	£28,624
HGG cohort - Prior TMZ									
SoC (BSC)	£20,873	████████	0.45	–	–	–	–	–	–
D+T	████████	████████	████████	████████	1.88	████████	£49,423	████████	£29,072

Note: all results presented are discounted unless otherwise stated.

[†]undiscounted; [‡]disease severity modifier of 1.2; [§]disease severity modifier of 1.7.

Abbreviations: BSC, best supportive care; C, carboplatin; D, dabrafenib; ICER, incremental cost-effectiveness ratio; incr., incremental; LYG, life-year gained; PAS: patient access scheme; QALY, quality-adjusted life year; T, trametinib; TMZ, temozolomide; V, vincristine.

Table 59: Net health benefits (PAS price)

Technologies	Total costs (£)	Total QALYs	Incr. costs (£)	Excluding disease severity modifier		Including disease severity modifier	
				NHB at £20,000	NHB at £30,000	NHB at £20,000	NHB at £30,000
LGG cohort							
SoC (C+V)	£88,450	11.39	–	–	–	–	–
D+T	████████	████████	████████	–1.22	–0.08	–0.78 [‡]	0.36
HGG cohort - No prior TMZ							
SoC (TMZ)	£27,339	0.73	–Wo	–	–	–	–
D+T	████████	████████	████████	–4.17	–1.81	–2.13 [§]	0.23
HGG cohort - Prior TMZ							
SoC (BSC)	£20,873	0.45	–	–	–	–	–
D+T	████████	████████	████████	–1.97	–0.87	–1.04 [§]	0.07

[‡]disease severity modifier of 1.2; [§]disease severity modifier of 1.7.

Abbreviations: BSC, best supportive care; C, carboplatin; D, dabrafenib; HGG, high-grade glioma; Incr., incremental; LGG, low-grade glioma; NHB, net health benefit; QALY, quality-adjusted life year; T, trametinib; TMZ, temozolomide.

B.3.9.1.1 LGG cohort

The base-case incremental cost-effectiveness results for the LGG cohort show that over a lifetime time horizon, the total costs associated with D+T were ██████████ compared with £88,452 for patients treated with current clinical management in the UK (C+V), representing an incremental cost of ██████████.

The total QALYs (prior any disease severity modifiers) for patients receiving D+T were ██████████ compared with 11.39 for patients treated with current clinical management in the UK representing an incremental QALY gain of ██████████, resulting in an ICER of £31,102 per QALY gained. The incremental QALY gained, accounting for the disease modifier of 1.2 increase the incremental QALYs to ██████████, results in an ICER of £25,918 per QALY gained.

B.3.9.1.2 HGG cohort: No prior TMZ

The base-case incremental cost-effectiveness results for the HGG cohort not previously treated with TMZ show that over a lifetime time horizon, the total costs associated with D+T were ██████████ compared with £27,339 for patients treated with current clinical management (TMZ) in the UK (an incremental cost of ██████████).

The total QALYs (prior any disease severity modifiers) for patients receiving D+T were ██████████ compared with 0.73 for patients treated with current clinical management in the UK (an incremental QALY gain of ██████████), resulting in an ICER of £48,660 per QALY gained. The incremental QALY gained, accounting for the disease modifier of 1.7 increase the incremental QALYs to ██████████, results in an ICER of £28,624 per QALY gained.

B.3.9.1.3 HGG cohort: Prior TMZ

The base-case incremental cost-effectiveness results for the HGG cohort previously treated with TMZ show that over a lifetime time horizon, the total costs associated with D+T were ██████████ compared with £20,873 for patients treated with current clinical management in the UK (an incremental cost of ██████████).

The total QALYs (prior any disease severity modifiers) for patients receiving D+T were ██████████ compared with 0.45 for patients treated with current clinical management in the UK (an incremental QALY gain of ██████████), resulting in an ICER of £49,423 per QALY gained. The incremental QALY gained, accounting for the disease modifier of 1.7 increase the incremental QALYs to ██████████, results in an ICER of £29,072 per QALY gained.

B.3.10 Exploring uncertainty

Results for the sensitivity analysis are presented applying the disease severity multipliers.

B.3.10.1 Probabilistic sensitivity analysis

A PSA was conducted in order to assess the simultaneous effect of uncertainty in the different model parameters. A Monte-Carlo simulation with 1,000 iterations was performed and, in each iteration, model inputs were randomly sampled from the specified probability distributions described in Table 56. An arbitrary standard error of 10% around the mean was assumed when the standard error or 95% CI was not available. Survival distribution and regression models were varied using multivariate normal distributions. Proportions were varied using a Dirichlet distribution or beta distribution (when binary). Costs and utility values were varied using a gamma and beta distribution, respectively. Treatment effect (HR) were varied using a log-normal distribution. KM curves were not varied. The results of the PSA are presented in Table 60, with the cost-effectiveness (CE) plane and cost-effectiveness acceptability curves (CEAC) resulting from the PSA in Figure 37.

Table 60: PSA results (PAS price)

Technologies	Total costs (£)	Total QALYs	Incr. costs (£)	Incr. QALYs	ICER (£/QALY)	Probability of cost-effectiveness [†]
LGG cohort						
SoC (C+V)	£86,779	13.19	–	–	–	–
D+T	████████	████████	████████	████████	£26,630	87.60%
HGG cohort - No prior TMZ						
SoC (TMZ)	£27,720	1.39	–	–	–	–
D+T	████████	████████	████████	████████	£28,186	69.60%
HGG cohort - Prior TMZ						
SoC (BSC)	£21,375	0.77	–	–	–	–
D+T	████████	████████	████████	████████	£28,575	75.90%

Note: all results presented are discounted unless otherwise stated.

[†]The probability of D+T being cost-effective vs clinical management in the UK at a WTP threshold of £30,000/QALY; [‡]disease severity modifier of 1.2; [§]disease severity modifier of 1.7.

Abbreviations: BSC, best supportive care; C: carboplatin; D, dabrafenib; HGG, high-grade glioma; ICER, incremental cost-effectiveness ratio; incr., incremental; LGG, low-grade glioma; PAS: patient access scheme; QALY, quality-adjusted life year; T, trametinib; TMZ, temozolomide; UK, United Kingdom; V, vincristine; WTP, willingness-to-pay.

Figure 37: PSA cost-effectiveness plane and CEAC (PAS price)

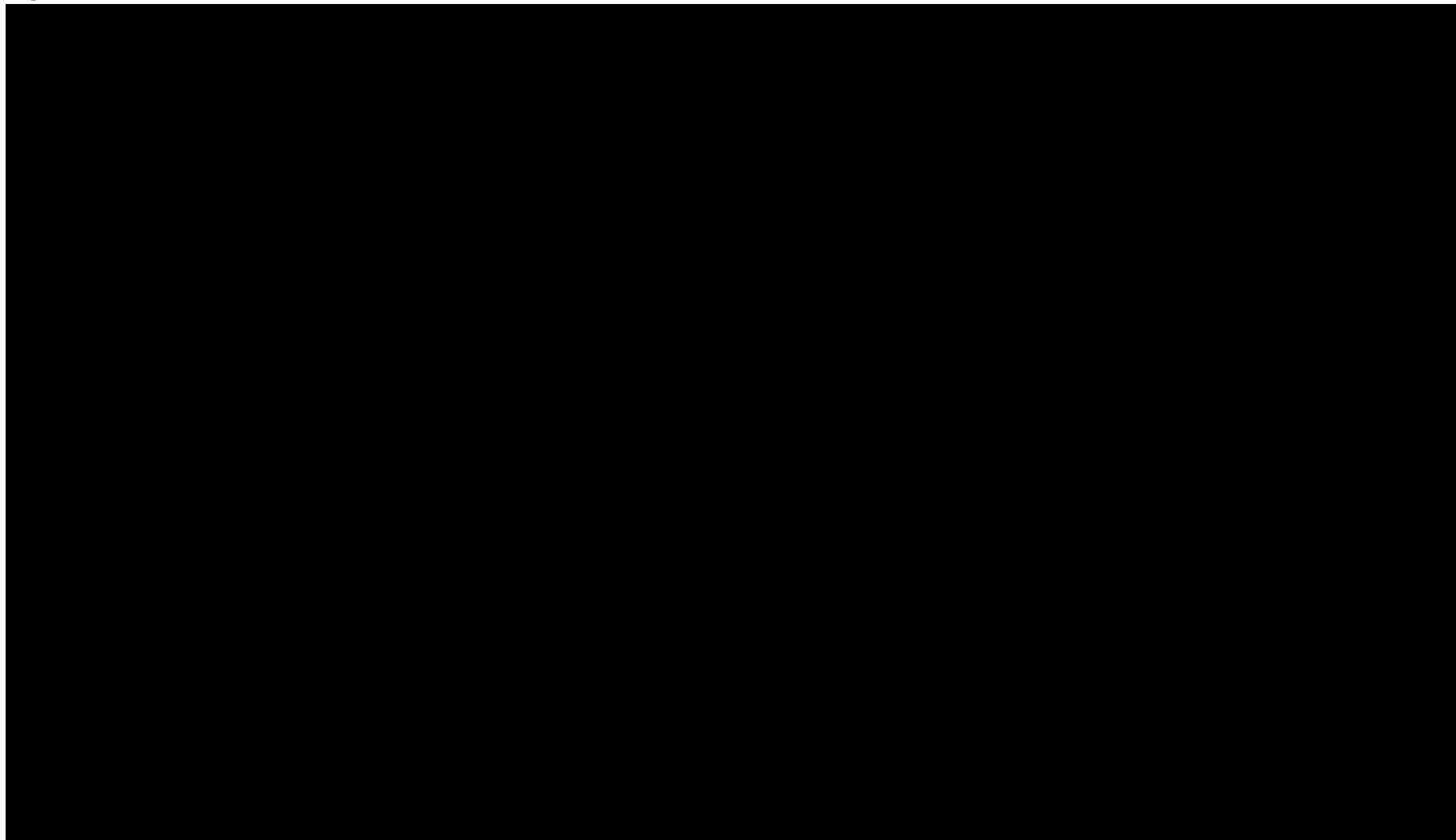

Note: all results presented are discounted unless otherwise stated. Disease severity modifier of 1.2 for LGG; disease severity modifier of 1.7 for HGG.
Abbreviations: BSC, best supportive care; CE, cost-effectiveness; CEAC, cost-effectiveness acceptability curve; D, dabrafenib; HGG, high-grade glioma; ICER, incremental cost-effectiveness ratio; LGG, low-grade glioma; PSA, probabilistic sensitivity analysis; QALY, quality-adjusted life year; T, trametinib; TMZ, temozolomide; WTP, willingness-to-pay threshold.

B.3.10.1.1 LGG cohort

Results of the PSA (Table 60) show that in the LGG cohort, over a lifetime time horizon, D+T was associated with greater QALYs (██████), at a greater cost (██████) compared with current clinical management in the UK (13.19 QALYs and £86,779, respectively). As such, the average PSA ICER was £26,630 per QALY gained, with an 87.6% probability of D+T being a cost-effective treatment option at a £30,000/QALY gained WTP threshold. The CE plane and cost-effectiveness acceptability curve for the LGG cohort are presented in Figure 37.

B.3.10.1.2 HGG cohort: No prior TMZ

Results of the PSA (Table 60) show that in the HGG cohort not previously treated with TMZ, over a lifetime time horizon, D+T is associated with greater QALYs (██████), at a greater cost (██████) compared with current clinical management in the UK (1.39 QALYs and £27,720, respectively). As such, the average PSA ICER was £28,186 per QALY gained, with a 69.6% probability of D+T being a cost-effective treatment option at a £30,000/QALY gained WTP threshold.

B.3.10.1.3 HGG cohort: Prior TMZ

Results of the PSA (Table 60) show that in the HGG cohort previously treated with TMZ, over a lifetime time horizon, D+T was associated with greater QALYs (██████), at a greater cost (██████) compared with current clinical management in the UK (0.77 QALYs and £21,375, respectively). As such, the average PSA ICER was £28,575 per QALY gained, with a 75.9% probability of D+T being a cost-effective treatment option at a £30,000/QALY gained WTP threshold.

B.3.10.2 Deterministic sensitivity analysis

In order to assess the robustness of the base-case cost-effectiveness results, deterministic sensitivity analyses (DSA) were conducted by varying one model input at a time to assess which parameters had the most impact on the ICER. Parameters were varied within their 95% CI where available (or possible to calculate) or within a reasonable range (+/- 20%).

The results for the 10 most influential parameters assessed in the DSA and the ICERs calculated at the upper and lower bounds are shown graphically in the tornado plot in Figure 38, sorted from the widest to narrowest range of ICER values to highlight the parameters with the strongest influence on the cost-effectiveness results. Unsurprisingly, the results of the DSA show that results were most sensitive to the assumptions around the discount rates for benefit, treatment effect for PFS (for HGG cohort only), and assumptions around utility values.

Figure 38: Tornado diagram based on DSA results (PAS price)

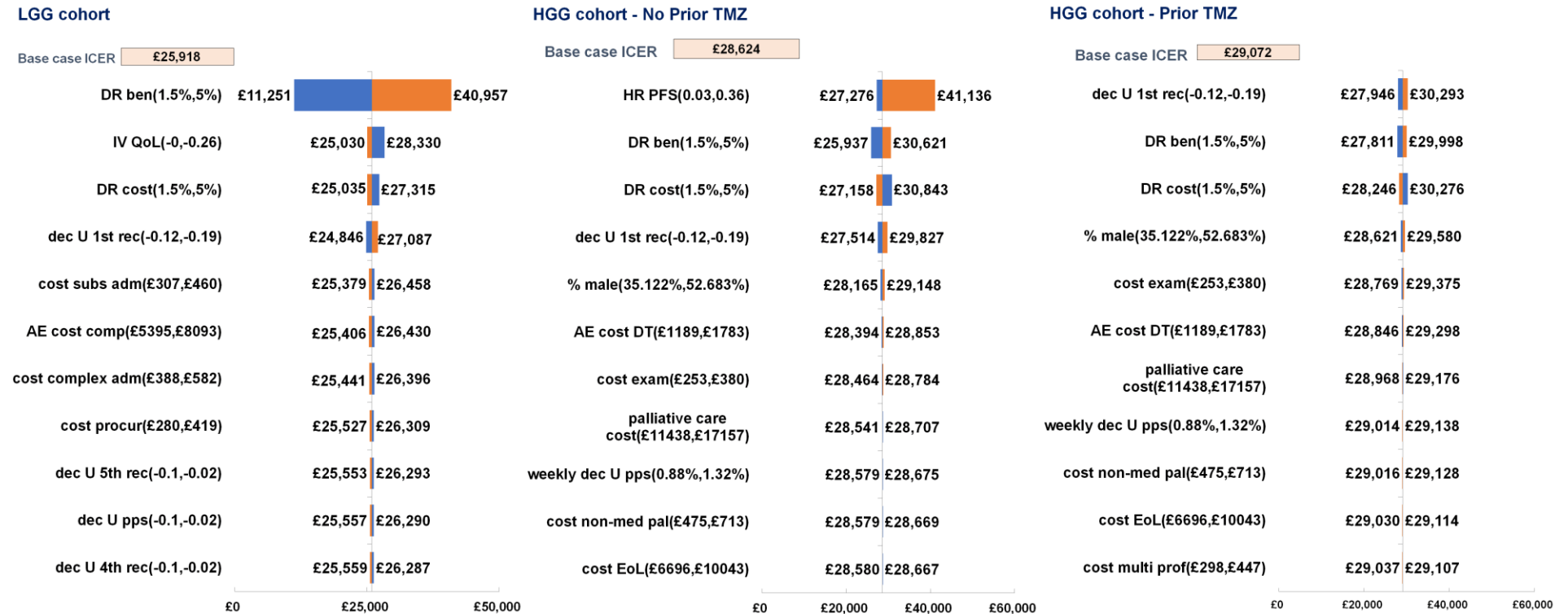

Note: all results presented are discounted unless otherwise stated. Disease severity modifier of 1.2 for LGG; disease severity modifier of 1.7 for HGG. Abbreviations: adm, administration; AE, adverse event; BSC, ben, benefit; best supportive care; CI, confidence interval; comp, complex; D, dabrafenib; dec, decrement; DR, discount rate; DSA, deterministic sensitivity analysis; ECG, electrocardiogram; EoL, end of life; exam, examination; gen pop, general population; HGG, high-grade glioma; HR, hazard ratio; HRQoL, health-related quality of life; ICER, incremental cost-effectiveness ratio; IV, intravenous; LGG, low-grade glioma; med, medical; MRI, magnetic resonance imaging; OS, overall survival; PAS, patient access scheme; pal, palliative; PFS, progression-free survival; PPS, post-progression survival; procur, procurement; prof, professional; QALY, quality-adjusted life year; QoL, quality of life; rec, recurrence; subs, subsequent; T, trametinib; TMZ, temozolomide; U, utility.

Figure 39: Scenario analysis results (PAS price)

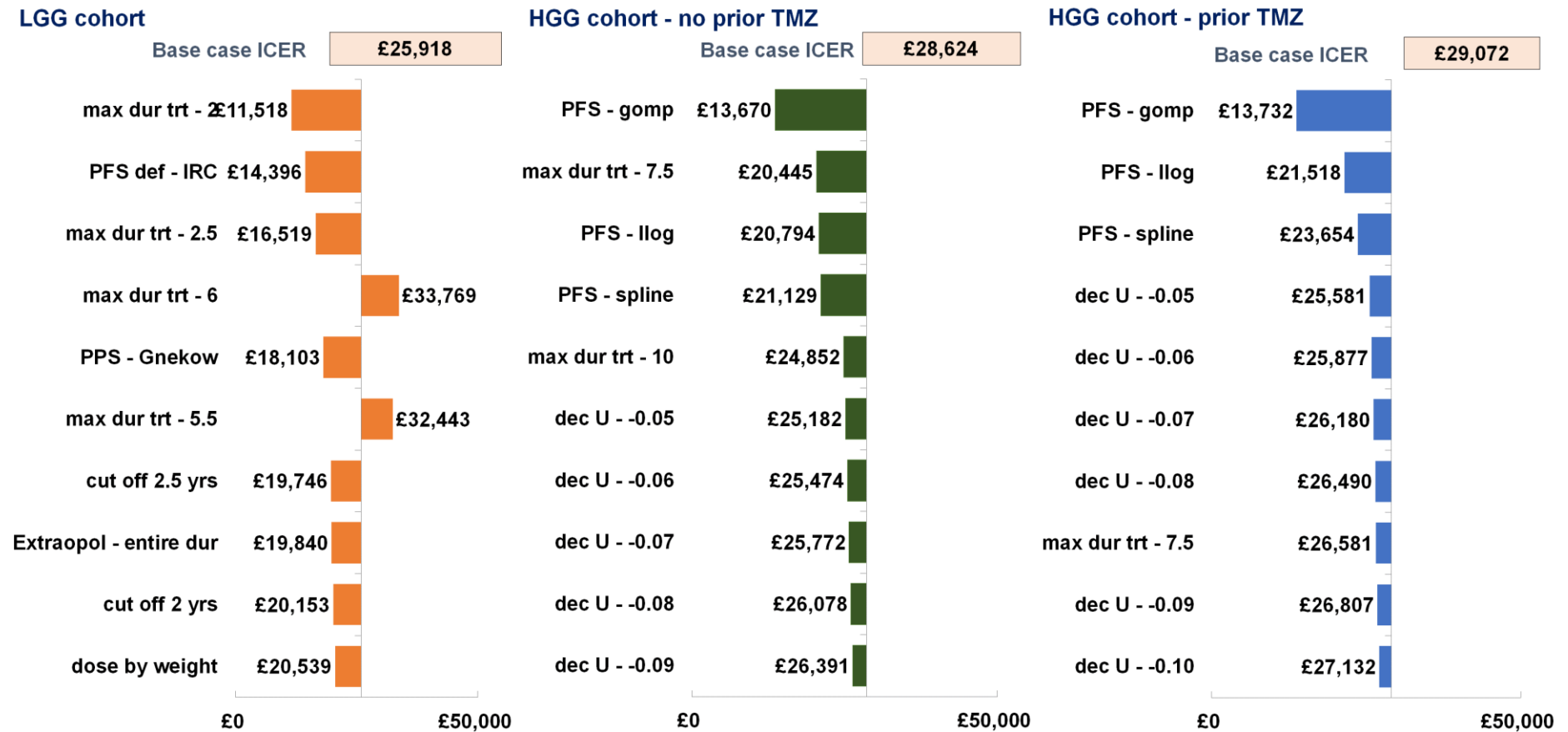

Note: all results presented are discounted unless otherwise stated. Disease severity modifier of 1.2 for LGG; disease severity modifier of 1.7 for HGG.
 Abbreviations: AE, adverse event; BSC, best supportive care; D, dabrafenib; def, definition; dur, duration; extrapol, extrapolation; HGG, high-grade glioma; HR, hazard ratio; ICER, incremental cost-effectiveness ratio; IRC, independent central; KM, Kaplan-Meier; LGG, low-grade glioma; LY, life-year; max, maximum; NHS, National Health Service; OS, overall survival; PAS, patient access scheme; PFS, progression-free survival; PPS, post-progression survival; QALY, quality-adjusted life year; PAS, patient access scheme; T, trametinib; TMZ, temozolomide; trt, treatment; TTD, time to treatment discontinuation; yrs, years.

B.3.10.3 Scenario analysis

In addition to the DSA, extensive scenario analyses were conducted altering important variables in the cost-effectiveness model. The list of scenario analyses conducted is available in Appendix Q. Results of the top 10 scenario analyses that most significantly impacted the ICER are presented below in Figure 39. The full list of results is available in Appendix Q.

The scenarios that result in the largest impact on the ICER are those around the extrapolation method for PFS, the treatment duration and utility values.

B.3.11 Benefits not captured in the QALY calculation.

The economic analysis has attempted to capture all the potential benefits related to D+T within the QALY calculation that are quantifiable. There are, however, several potential benefits of treatment with D+T which are not captured within the assessment and not quantifiable that should be considered, specifically:

- The positive impact of an oral treatment including the benefit on NHS capacity through the reduction in patients requiring IV chemotherapy, amid the current backlogs faced by the NHS. Avoiding hospital visits reduces the financial and administrative strain on NHS capacity. While direct costs (i.e., chemotherapy) are captured, keeping patients away from hospital and alleviating some burden on NHS staff and infrastructure (i.e. human and physical capital) are crucial elements to consider at a time when the NHS continues to face significant backlogs from the COVID-19 pandemic.
- In addition to helping alleviate capacity issues within the NHS, reducing hospital visits will also have a positive impact on patient and carer quality of life (QoL), as both may experience increased anxiety and stress. The availability of an oral treatment would also improve carer QoL, due to the increased stress and anxiety for carers having to attend hospital appointments, take time off work and financial loss to the family.
- The likely positive impact on patient well-being associated with a treatment that is targeted and shown to be highly effective as well as patient preferences for an oral treatment (25).
- The benefits in quality of life for carers is substantial but are difficult to capture in the QALY calculation and there is no guidance on how this should be captured.

Given the above, it is plausible that additional potential benefits of D+T were not captured in the QALY (and ICER) calculation, however, it remains important to consider these factors.

B.3.12 Validation

B.3.12.1 Validation of cost-effectiveness analysis

Clinical validation was sought to support with this submission, consisting of individual interviews with two clinical experts (28, 29). The number of experts involved reflect the rarity of the condition and mutation. The two clinical experts were leading medical and clinical oncologists with experience in the management of paediatric patients with glioma.

The following key aspects were discussed and validated:

- the natural history and clinical pathway for paediatric patients with *BRAF* V600E mutation-positive glioma
- description of the current SoC
- key benefits (and adverse reactions) expected from the use of D+T for the treatment of paediatric patients with glioma
- treatment duration with D+T in clinical practice
- plausibility of the survival extrapolations.

In addition to clinical validation of model inputs, the cost-effectiveness model was quality assured by a health economist not involved in the model building who reviewed the model for coding errors, inconsistencies, and plausibility of inputs. The model was also subject to stress testing of extreme scenarios to test for known modelling errors and questioning of results.

While comparison with external studies are often challenging due to some differences in population, predictions were also compared against external data (Appendix J) and shown to broadly align with published data in *BRAF* V600E mutation-positive paediatric patients with LGG (Ryall 2020 (112); Lassaletta 2017 (20)) or molecularly unselected patients with HGG (Verschuur 2004 (66); MacDonald 2013 (94); Narayana 2010 (95)).

B.3.13 Interpretation and conclusions of economic evidence

Owing to the severity of the disease, paediatric patients with glioma experience a substantial QALY shortfall, compared with the general population (Section B.3.6), and therefore, D+T in this indication meet the criteria for decision modifiers for severity of disease. The base-case analysis shows that D+T is a cost-effective option for the treatment of children and adolescents with *BRAF* V600E mutation-positive glioma. D+T was associated with higher costs but also higher QALYs than current UK clinical management, with an incremental cost per QALY gained of £25,918 in the LGG cohort, £28,624 in patients with HGG previously treated with TMZ, and £29,072 in patients with HGG not previously treated with TMZ.

Sensitivity and scenario analyses indicated that the ICER was robust to plausible changes, apart from assumptions around the duration of treatment, treatment effect, and utility values. The ICER was also sensitive to the choice of parametric extrapolation.

Strengths of the economic analysis include:

The economic analysis is underpinned by a well-designed Phase 2 RCT (TADPOLE) that is representative of the population expected to be treated with D+T in England and Wales. It is also important to note that this trial is the only trial conducted in patients with a *BRAF* V600E mutation, and also included UK patients.

- The economic analysis includes all the relevant evidence available that are likely to arise during this appraisal. Notably, data from the final data cut of TADPOLE are used in the economic analysis
- The model structure and assumptions were developed with input from two UK clinical experts specialising in the treatment of paediatric patients with glioma
- Uncertainty in the model inputs and assumptions was explored in a large number of scenario and sensitivity analyses that demonstrate the robustness of the model results to most assumptions and inputs
- An individual based approach was employed to provide flexibility in the model and reflects how D+T will be used in clinical practice
- Internal and external validation were conducted.

Limitations of the analysis include:

- Overall survival data are immature in the LGG cohort and confounded by crossover, with no deaths in the D+T arm and one death in the C+V arm of TADPOLE. This high survival rate reflects both the prognosis of patients with LGG and the potential benefits of D+T on survival. In the economic model, OS is derived from PFS based on external evidence that is associated with uncertainties. Notably, Kandels 2020 reported the rate of death following progression in patients that are molecularly unselected rather than those with a *BRAF* V600E mutation (79)
- The absence of a head-to-head trial between D+T and current clinical management meant that indirect evidence was used to estimate the efficacy in patients receiving current clinical management in the UK, thus there is uncertainty surrounding the

estimates. Likewise, there is a paucity of evidence available for the efficacy (PFS, OS) and safety (incidence of AEs) of the comparators in paediatric patients with *BRAF* V600E mutation-positive glioma, and in the absence of such evidence, data from molecularly unselected patients was utilised, leading to uncertainty in the estimates. It remains unclear if *BRAF* V600E is a prognostic factor for PFS and OS in patients that are relapsed/refractory. In the first-line setting, Rosenberg 2022, reported the 3-year PFS for known *BRAF*-mutant (n=28) vs *BRAF* wild-type patients (n=260) as 17% (95% CI: 5, 36) and 18% (95% CI: 14, 24), respectively. However, while no statistically significant difference was observed for PFS (p=0.15), the study reported the 3-year OS for known *BRAF*-mutant vs *BRAF*-wildtype patients as 57% (95% CI: 40, 75) and 30% (95% CI: 23, 36), respectively (p=0.003). The study cautioned about interpreting the data for OS, as data regarding the use of salvage regimens is lacking. The economic model used PFS as a surrogate for OS, and assumed the same PPS derived from the TADPOLE study. Therefore, any prognosis impact of *BRAF* V600E on survival is likely to be mitigated in the economic model, however, remains uncertain

- The maximum duration patients remain on treatment is highly uncertain and is a key driver for the cost-effectiveness results. In the base case, patients were assumed to be treated for a maximum of 3.5 years in the absence of progression and up to the age of 25 years to reflect clinical expert expectation. Extensive scenario analyses were conducted for transparency, and unsurprisingly, the ICERs were less favourable when the maximum treatment duration increased
- Extrapolations for PFS remain uncertain. Scenario analyses were conducted using different parametric extrapolation
- There are several evidence gaps and uncertainties often associated with rare diseases. No data exist on the management of HGG in the UK. In the absence of UK data, the type and frequency of resource use was based on the average resource use estimated by two clinical experts; this is therefore uncertain. EQ-5D was also not collected in the trial as it is not an appropriate measure in young children, therefore, data from adults were used
- Only the impact on bereavement was considered.

Concluding remarks

There is no reimbursed therapy for treating relapsed/refractory paediatric patients with HGG in England and Wales, and evidence shows that prognosis for these patients is very poor. While first-line C+V is the standard-of-care in for patients with LGG, there is a lack of NICE-recommended treatment options, and chemotherapy is associated with poorer outcomes in patients with a *BRAF* V600E mutation. Consequently, there is a high unmet need for a well-tolerated and effective therapy to reduce disease burden, delay progression, improve survival rates, and improve HRQoL. Despite gliomas being a rare condition, dabrafenib (Finley®) and trametinib (Spexotras®) were specifically developed for paediatric patients with glioma, as young children are unable to swallow tablets/capsules. The formulation of D+T may also improve tolerability amongst older children.

Due to the severity of the disease, disease severity modifiers apply. The cost-effectiveness analysis showed that D+T is a cost-effective treatment option compared with current clinical management in both LGG and HGG cohorts.

Dabrafenib with trametinib for treating *BRAF* V600E mutation-positive glioma in children and young people aged 1 to 17

The indication of this submission did not meet the criteria for an evaluation under the highly specialised technology (HST) route, due to D+T being recommended in other indications (as hard capsules). As paediatric glioma is a rare disease, this evaluation suffers from evidence constraints and challenges associated with small population numbers and the target population. As such, flexibility in decision-making should be considered by the committee. Such a situation is recognised in the NICE method guide, which states flexibility is allowed in cases where it is particularly difficult to generate enough evidence (e.g. for children or rare diseases), as per the evidence base for this submission. Without flexibility offered by the process, paediatric patients with glioma may be disadvantaged. To prevent potential inequality for paediatric patients suffering from a rare condition with significant unmet need, we urge the committee to exercise flexibility and evaluate the cost-effectiveness of D+T against the upper end of current WTP thresholds and consider further flexibility as afforded under the HST route.

Finally, treatment with dabrafenib and trametinib allows patients to be managed away from a hospital setting, and so may help alleviate NHS capacity issues in terms of IV administrations and reduce the burden of treatment-related adverse events compared with chemotherapy.

Appendices

Appendix C: Summary of product characteristics (SmPC) and UK public assessment report

Appendix D: Identification, selection and synthesis of clinical evidence

Appendix E: Subgroup analysis

Appendix F: Adverse reactions

Appendix G: Published cost-effectiveness studies

Appendix H: Health-related quality-of-life studies

Appendix I: Cost and healthcare resource identification, measurement and valuation

Appendix J: Clinical outcomes and disaggregated results from the model

Appendix K: Price details of treatments included in the submission

Appendix L: Checklist of confidential information

Appendix M: Additional methodology from TADPOLE

Appendix N: Additional efficacy and PK data from TADPOLE

Appendix O: Summary of the Phase 1/2 study NCT02124772

Appendix P: Extrapolation

Appendix Q: Scenario analyses

References

1. Cancer Research UK. What are children's brain tumours? Available at : <https://about-cancer.cancerresearchuk.org/about-cancer/childrens-cancer/brain-tumours/about> (Accessed June 2023). 2023.
2. Cancer Research UK. Children's cancer statistics. Available at: <https://www.cancerresearchuk.org/health-professional/cancer-statistics/childrens-cancers> (Accessed July 2023) 2023 [
3. Cancer Research UK. Glioma. Available at: <https://www.cancerresearchuk.org/about-cancer/brain-tumours/types/glioma-adults> (Accessed June 2023). 2023.
4. Ostrom QT, Gittleman H, Fulop J, Liu M, Blanda R, Kromer C, et al. CBTRUS Statistical Report: Primary Brain and Central Nervous System Tumors Diagnosed in the United States in 2008-2012. *Neuro Oncol.* 2015;17 Suppl 4(Suppl 4):iv1-iv62.
5. Ostrom QT, de Blank PM, Kruchko C, Petersen CM, Liao P, Finlay JL, et al. Alex's Lemonade Stand Foundation Infant and Childhood Primary Brain and Central Nervous System Tumors Diagnosed in the United States in 2007-2011. *Neuro Oncol.* 2015;16 Suppl 10(Suppl 10):x1-x36.
6. Louis DN, Ohgaki H, Wiestler OD, Cavenee WK, Burger PC, Jouvet A, et al. The 2007 WHO classification of tumours of the central nervous system. *Acta Neuropathol.* 2007;114(2):97-109.
7. Louis DN, Perry A, Reifenberger G, von Deimling A, Figarella-Branger D, Cavenee WK, et al. The 2016 World Health Organization Classification of Tumors of the Central Nervous System: a summary. *Acta Neuropathol.* 2016;131(6):803-20.
8. Louis DN, Perry A, Wesseling P, Brat DJ, Cree IA, Figarella-Branger D, et al. The 2021 WHO Classification of Tumors of the Central Nervous System: a summary. *Neuro Oncol.* 2021;23(8):1231-51.
9. Steliarova-Foucher E, Colombet M, Ries LAG, Hesselting P, Moreno F, Shin HY, et al. International Incidence of Childhood Cancer, Volume III (electronic version). Lyon, France: International Agency for Research on Cancer. Available from: <http://iicc.iarc.fr/results/> (Accessed June 2023). 2017.
10. Behling F, Schittenhelm J. Oncogenic BRAF Alterations and Their Role in Brain Tumors. *Cancers.* 2019;11(6):794.
11. Andrews LJ, Thornton ZA, Saincher SS, Yao IY, Dawson S, McGuinness LA, et al. Prevalence of BRAFV600 in glioma and use of BRAF Inhibitors in patients with BRAFV600 mutation-positive glioma: systematic review. *Neuro Oncol.* 2022;24(4):528-40.
12. Samir Saincher S, Higgins JPT, McAleenan A, Kurian KM. The Prevalence of BRAF Mutations in Patients with Glioma: A Systematic Review. *Neuro Oncol.* 2019;21(Suppl 4):iv13.
13. The Royal Marsden NHS Foundation Trust. Low-grade glioma. Available at: <https://www.royalmarsden.nhs.uk/your-care/cancer-types/paediatric-cancers/low-grade-glioma> (Accessed June 2023). 2023.
14. The Royal Marsden NHS Foundation Trust. High grade glioma. Available at: <https://www.royalmarsden.nhs.uk/your-care/cancer-types/paediatric-cancers/high-grade-glioma> (Accessed June 2023). 2023.
15. Blionas A, Giakoumettis D, Klonou A, Neromyliotis E, Karydakis P, Themistocleous MS. Paediatric gliomas: diagnosis, molecular biology and management. *Ann Transl Med.* 2018;6(12):251.
16. Brain Tumour Research. Glioma. Available at: <https://www.braintumourresearch.org/info-support/types-of-brain-tumour/glioma> (Accessed June 2023). 2023.
17. Mistry M, Zhukova N, Merico D, Rakopoulos P, Krishnatry R, Shago M, et al. BRAF mutation and CDKN2A deletion define a clinically distinct subgroup of childhood secondary high-grade glioma. *J Clin Oncol.* 2015;33(9):1015-22.

18. Bhat SR, Goodwin TL, Burwinkle TM, Lansdale MF, Dahl GV, Huhn SL, et al. Profile of daily life in children with brain tumors: an assessment of health-related quality of life. *J Clin Oncol*. 2005;23(24):5493-500.
19. Perkins N. Brain Tumour Research. The high price of brain tumours. Available at: <https://www.braintumourresearch.org/media/our-blog/blog-item/our-blog/2020/03/27/the-high-price-of-brain-tumours> (Accessed June 2023). 2020.
20. Lassaletta A, Zapotocky M, Mistry M, Ramaswamy V, Honnorat M, Krishnatry R, et al. Therapeutic and Prognostic Implications of BRAF V600E in Pediatric Low-Grade Gliomas. *J Clin Oncol*. 2017;35(25):2934-41.
21. Sadighi ZS, Curtis E, Zabrowski J, Billups C, Gajjar A, Khan R, et al. Neurologic impairments from pediatric low-grade glioma by tumor location and timing of diagnosis. *Pediatr Blood Cancer*. 2018;65(8):e27063.
22. European Medicines Agency. Meeting report on the paediatric high-grade glioma medicines expert workshop. Available at: https://www.ema.europa.eu/en/documents/report/meeting-report-paediatric-high-grade-glioma-medicines-expert-workshop_en.pdf (Accessed August 2023). 2011.
23. MHRA. Carboplatin 10 mg/ml solution for infusion. Patient information leaflet. Available at: <https://mhraproducts4853.blob.core.windows.net/docs/3c72c6a28033e9174c3e63bbf8b8b7a4e609fa0c>. 2018.
24. MHRA. VINCRISTINE SULFATE 1 MG/ML INJECTION. Summary of Product Characteristics. Available at: <https://mhraproducts4853.blob.core.windows.net/docs/db7ff847531165ba6a631d894751806fd8edfbff>.
25. Eek DK, M. Mazar, I. Horsfield, A. Pompilus, F. Friebe, R. Shields, A. Patient-reported preferences for oral versus intravenous administration for the treatment of cancer: a review of the literature. *Patient Prefer Adherence*. 10:1609-1621. 2016.
26. National Institute for Health and Care Excellence (NICE). Dabrafenib with trametinib for treating BRAF V600E mutation-positive glioma in children and young people aged 1 to 17. Final scope. Available at: <https://www.nice.org.uk/guidance/indevelopment/gid-ta11006> [Last accessed 30th August 2023]. 2023.
27. Picton S, Kilday J, Hargrave D, Bailey S, O'Hare P, Ajithkumar T, et al. Guidelines for the diagnosis and management of paediatric and adolescent Low-Grade Glioma. Children's Cancer and Leukaemia Group. 2020.
28. Novartis. Data on file. Individual clinician consultation. 10th August 2023. 2023.
29. Novartis. Data on file. Individual clinician consultation. 15th September 2023. 2023.
30. European Medicines Agency. Temozolomide. Summary of product characteristics (last updated 17 December 2008). Available at: https://www.ema.europa.eu/en/documents/product-information/temodal-epar-product-information_en.pdf (Accessed August 2023). 2008.
31. Guerra-García P, Marshall LV, Cockle JV, Ramachandran PV, Saran FH, Jones C, et al. Challenging the indiscriminate use of temozolomide in pediatric high-grade gliomas: A review of past, current, and emerging therapies. *Pediatr Blood Cancer*. 2020;67(1):e28011.
32. Perwein T, Giese B, Nussbaumer G, von Bueren AO, van Buijen M, Benesch M, et al. How I treat recurrent pediatric high-grade glioma (pHGG): a Europe-wide survey study. *J Neurooncol*. 2023;161(3):525-38.
33. Novartis. Data on file. Dabrafenib for paediatric glioma. Draft Summary of Product Characteristics. 2023.
34. Novartis. Data on file. Trametinib for paediatric glioma. Draft Summary of Product Characteristics. 2023.
35. Bowyer S, Lee R, Fusi A, Lorigan P. Dabrafenib and its use in the treatment of metastatic melanoma. *Melanoma Manag*. 2015;2(3):199-208.
36. Lugowska I, Kosela-Paterczyk H, Kozak K, Rutkowski P. Trametinib: a MEK inhibitor for management of metastatic melanoma. *Onco Targets Ther*. 2015;8:2251-9.

37. Khunger A, Khunger M, Velcheti V. Dabrafenib in combination with trametinib in the treatment of patients with BRAF V600-positive advanced or metastatic non-small cell lung cancer: clinical evidence and experience. *Therapeutic Advances in Respiratory Disease*. 2018;12:1753466618767611.
38. European Medicines Agency. Meeting highlights from the Committee for Medicinal Products for Human Use (CHMP) 11-14 September 2023. Available at: <https://www.ema.europa.eu/en/news/meeting-highlights-committee-medicinal-products-human-use-chmp-11-14-september-2023> (Accessed September 2023). 2023.
39. Novartis. Clinical study report - Final analysis - April 2023. Phase II open-label global study to evaluate the effect of dabrafenib in combination with trametinib in children and adolescent patients with BRAF V600 mutation positive Low Grade Glioma (LGG) or relapsed or refractory High Grade Glioma (HGG). 2023.
40. Novartis. Clinical study report - Primary analysis. Phase II open-label global study to evaluate the effect of dabrafenib in combination with trametinib in children and adolescent patients with BRAF V600 mutation positive Low Grade Glioma (LGG) or relapsed or refractory High Grade Glioma (HGG). 2022.
41. Chatwin HV, Cruz Cruz J, Green AL. Pediatric high-grade glioma: moving toward subtype-specific multimodal therapy. *Febs j*. 2021;288(21):6127-41.
42. Tan JY, Wijesinghe IVS, Alfarizal Kamarudin MN, Parhar I. Paediatric Gliomas: BRAF and Histone H3 as Biomarkers, Therapy and Perspective of Liquid Biopsies. *Cancers (Basel)*. 2021;13(4).
43. Lehmann R, Rayner BS, Ziegler DS. Resistance mechanisms in BRAF(V600E) paediatric high-grade glioma and current therapeutic approaches. *Front Oncol*. 2022;12:1031378.
44. Kavya SG, Reghu R. An Overview of High-grade Glioma: Current and Emerging Treatment Approaches. *Current Cancer Therapy Reviews*. 2021;17(1):35-48.
45. Green K, Panagopoulou P, D'Arco F, O'Hare P, Bowman R, Walters B, et al. A nationwide evaluation of bevacizumab-based treatments in pediatric low-grade glioma in the UK: Safety, efficacy, visual morbidity, and outcomes. *Neuro Oncol*. 2023;25(4):774-85.
46. Nobre L, Zapotocky M, Ramaswamy V, Ryall S, Bennett J, Alderete D, et al. Outcomes of BRAF V600E Pediatric Gliomas Treated With Targeted BRAF Inhibition. *JCO Precision Oncology*. 2020(4):561-71.
47. Desjardins L, Barrera M, Schulte F, Chung J, Cataudella D, Janzen L, et al. Predicting social withdrawal, anxiety and depression symptoms in pediatric brain tumor survivors. *J Psychosoc Oncol*. 2019;37(1):22-36.
48. de Blank PM, Ostrom QT, Rouse C, Wolinsky Y, Kruchko C, Salcido J, et al. Years of life lived with disease and years of potential life lost in children who die of cancer in the United States, 2009. *Cancer Med*. 2015;4(4):608-19.
49. Kristiansen I, Strinnholm M, Strömberg B, Frisk P. Clinical characteristics, long-term complications and health-related quality of life (HRQoL) in children and young adults treated for low-grade astrocytoma in the posterior fossa in childhood. *J Neurooncol*. 2019;142(1):203-10.
50. Nwachukwu CR, Youland RS, Chioreso C, Wetjen N, NageswaraRao A, Keating G, et al. Health related quality of life (HRQOL) in long-term survivors of pediatric low grade gliomas (LGGs). *J Neurooncol*. 2015;121(3):599-607.
51. de Lande RSV, Maurice-Stam H, Marchal JP, Vuurden DGV, Vandertop WP, Grootenhuis MA, et al. Adaptive behavior impaired in children with low-grade glioma. *Pediatr Blood Cancer*. 2019;66(1):e27419.
52. Boele FW, Meads D, Jansen F, Verdonck-de Leeuw IM, Heimans JJ, Reijneveld JC, et al. Healthcare utilization and productivity loss in glioma patients and family caregivers: the impact of treatable psychological symptoms. *J Neurooncol*. 2020;147(2):485-94.
53. Kumthekar P, Stell BV, Jacobs DI, Helenowski IB, Rademaker AW, Grimm SA, et al. Financial burden experienced by patients undergoing treatment for malignant gliomas. *Neurooncol Pract*. 2014;1(2):71-6.

54. National Institute for Health and Care Excellence (NICE). Brain tumours (primary) and brain metastases in over 16s. NICE guideline [NG99]. Available at: <https://www.nice.org.uk/guidance/ng99/chapter/Recommendations>. 2021.
55. NCCN. NCCN Clinical Practice Guidelines in Oncology. Central Nervous System Cancers. Version 1.2023. 2023.
56. Stupp R, Brada M, van den Bent MJ, Tonn JC, Pentheroudakis G. High-grade glioma: ESMO Clinical Practice Guidelines for diagnosis, treatment and follow-up. *Ann Oncol*. 2014;25 Suppl 3:iii93-101.
57. Gnekow AK, Kandels D, Tilburg CV, Azizi AA, Opocher E, Stokland T, et al. SIOP-E-BTG and GPOH Guidelines for Diagnosis and Treatment of Children and Adolescents with Low Grade Glioma. *Klin Padiatr*. 2019;231(3):107-35.
58. MacDonald TJ, Aguilera D, Kramm CM. Treatment of high-grade glioma in children and adolescents. *Neuro Oncol*. 2011;13(10):1049-58.
59. Douw L, Klein M, Fagel SS, van den Heuvel J, Taphoorn MJ, Aaronson NK, et al. Cognitive and radiological effects of radiotherapy in patients with low-grade glioma: long-term follow-up. *Lancet Neurol*. 2009;8(9):810-8.
60. Metselaar DS, du Chatinier A, Stuiver I, Kaspers GJL, Hulleman E. Radiosensitization in Pediatric High-Grade Glioma: Targets, Resistance and Developments. *Front Oncol*. 2021;11:662209.
61. Gale N. Brain Tumour Research. What are paediatric-type diffuse high-grade gliomas? Available at: <https://www.braintumourresearch.org/media/our-blog/blog-item/our-blog/2023/03/09/what-are-paediatric-type-diffuse-high-grade-gliomas> (Accessed June 2023). 2020.
62. Lashford LS, Thiesse P, Jouvett A, Jaspan T, Couanet D, Griffiths PD, et al. Temozolomide in malignant gliomas of childhood: a United Kingdom Children's Cancer Study Group and French Society for Pediatric Oncology Intergroup Study. *J Clin Oncol*. 2002;20(24):4684-91.
63. Le Teuff G, Castaneda-Heredia A, Dufour C, Jaspan T, Calmon R, Devos A, et al. Phase II study of temozolomide and topotecan (TOTEM) in children with relapsed or refractory extracranial and central nervous system tumors including medulloblastoma with post hoc Bayesian analysis: A European ITCC study. *Pediatr Blood Cancer*. 2020;67(1):e28032.
64. Nicholson HS, Kretschmar CS, Krailo M, Bernstein M, Kadota R, Fort D, et al. Phase 2 study of temozolomide in children and adolescents with recurrent central nervous system tumors: a report from the Children's Oncology Group. *Cancer*. 2007;110(7):1542-50.
65. Ruggiero A, Cefalo G, Garre ML, Massimino M, Colosimo C, Attina G, et al. Phase II trial of temozolomide in children with recurrent high-grade glioma. *J Neurooncol*. 2006;77(1):89-94.
66. Verschuur AC, Grill J, Lelouch-Tubiana A, Couanet D, Kalifa C, Vassal G. Temozolomide in paediatric high-grade glioma: a key for combination therapy? *Br J Cancer*. 2004;91(3):425-9.
67. Warren KE, Gururangan S, Geyer JR, McLendon RE, Poussaint TY, Wallace D, et al. A phase II study of O6-benzylguanine and temozolomide in pediatric patients with recurrent or progressive high-grade gliomas and brainstem gliomas: a Pediatric Brain Tumor Consortium study. *J Neurooncol*. 2012;106(3):643-9.
68. Gillespie TW. Advances in Oral Oncolytic Agents for Breast Cancer and Recommendations for Promoting Adherence. *J Adv Pract Oncol*. 2020;11(1):83-96.
69. Bouffet E, Geoerger B, Moertel C, Whitlock JA, Aerts I, Hargrave D, et al. Efficacy and Safety of Trametinib Monotherapy or in Combination With Dabrafenib in Pediatric BRAF V600-Mutant Low-Grade Glioma. *J Clin Oncol*. 2023;41(3):664-74.
70. Medicines and Healthcare products Regulatory Agency. Tafinlar 50 mg hard capsules. Summary of Product Characteristics. Available at: <https://mhraproducts4853.blob.core.windows.net/docs/0da618a1eb1eafb86bd94f94330b9c2b4b990bf1>. 2023.

71. Hummel TR, Wagner L, Ahern C, Fouladi M, Reid JM, McGovern RM, et al. A pediatric phase 1 trial of vorinostat and temozolomide in relapsed or refractory primary brain or spinal cord tumors: a Children's Oncology Group phase 1 consortium study. *Pediatr Blood Cancer*. 2013;60(9):1452-7.
72. Phillippo DM, Ades AE, Dias S, Palmer S, Abrams KR, Welton NJ. NICE DSU TSD 18: Methods for Population-Adjusted Indirect Comparisons in Submissions To NICE 2016 [Available from: <https://www.sheffield.ac.uk/nice-dsu/tsds/population-adjusted>.
73. Phillippo DM, Ades AE, Dias S, Palmer S, Abrams KR, Welton NJ. Methods for population-adjusted indirect comparisons in health technology appraisal. *Medical decision making*. 2018;38(2):200-11.
74. Faria R, Hernandez Alava M, Manca A, Wailoo A. NICE DSU TSD 17: The use of observational data to inform estimates of treatment effectiveness in technology appraisal: Methods for comparative individual patient data 2016 [Available from: <https://www.sheffield.ac.uk/nice-dsu/tsds/observational-data>.
75. Guyot P, Ades AE, Ouwens MJ, Welton NJ. Enhanced secondary analysis of survival data: reconstructing the data from published Kaplan-Meier survival curves. *BMC Med Res Methodol*. 2012;12:9.
76. Qaddoumi I, Sultan I, Gajjar A. Outcome and prognostic features in pediatric gliomas: a review of 6212 cases from the Surveillance, Epidemiology, and End Results database. *Cancer*. 2009;115(24):5761-70.
77. Hargrave DR, Bouffet E, Tabori U, Broniscer A, Cohen KJ, Hansford JR, et al. Efficacy and Safety of Dabrafenib in Pediatric Patients with BRAF V600 Mutation-Positive Relapsed or Refractory Low-Grade Glioma: Results from a Phase I/IIa Study. *Clin Cancer Res*. 2019;25(24):7303-11.
78. National Institute for Health and Care Excellence (NICE). NICE health technology evaluations: the manual. Available at: <https://www.nice.org.uk/process/pmg36/chapter/introduction-to-health-technology-evaluation> [Last accessed: 30th August 2023]. 2022.
79. Kandels D, Pietsch T, Bison B, Warmuth-Metz M, Thomale UW, Kortmann RD, et al. Loss of efficacy of subsequent nonsurgical therapy after primary treatment failure in pediatric low-grade glioma patients-Report from the German SIOP-LGG 2004 cohort. *Int J Cancer*. 2020;147(12):3471-89.
80. Bouffet E, Jakacki R, Goldman S, Hargrave D, Hawkins C, Shroff M, et al. Phase II study of weekly vinblastine in recurrent or refractory pediatric low-grade glioma. *J Clin Oncol*. 2012;30(12):1358-63.
81. Drewes C, Sagberg LM, Jakola AS, Solheim O. Perioperative and Postoperative Quality of Life in Patients with Glioma—A Longitudinal Cohort Study. *World Neurosurgery*. 2018;117:e465-e74.
82. Vera E, Christ A, Grajkowska E, Briceno N, Choi A, Crandon SK, et al. Relationship between RANO-PRO Working Group standardised priority constructs and disease progression among malignant glioma patients: A retrospective cohort study. *EClinicalMedicine*. 2023;55:101718.
83. Hernandez Alava M, Pudney S, Wailoo A. Estimating the Relationship Between EQ-5D-5L and EQ-5D-3L: Results from a UK Population Study. *Pharmacoeconomics*. 2023;41(2):199-207.
84. National Health Service England. National Cost Collection Data for 2021-2022. Available at: <https://www.england.nhs.uk/costing-in-the-nhs/national-cost-collection/>. 2023.
85. PSSRU. Unit Costs of Health and Social Care 2022. <https://www.pssru.ac.uk/unitcostsreport/>. 2022.
86. British National Formulary. British National Formulary (BNF). NICE. Available at: <https://bnf.nice.org.uk/>. 2023.
87. Gov.uk. Drugs and pharmaceutical electronic market information tool (eMIT). Available at: <https://www.gov.uk/government/publications/drugs-and-pharmaceutical-electronic-market-information-emit>. 2023.

88. Ater JL, Zhou T, Holmes E, Mazewski CM, Booth TN, Freyer DR, et al. Randomized study of two chemotherapy regimens for treatment of low-grade glioma in young children: a report from the Children's Oncology Group. *J Clin Oncol*. 2012;30(21):2641-7.
89. Gnekow AK, Walker DA, Kandels D, Picton S, Giorgio P, Grill J, et al. A European randomised controlled trial of the addition of etoposide to standard vincristine and carboplatin induction as part of an 18-month treatment programme for childhood (≤ 16 years) low grade glioma - A final report. *Eur J Cancer*. 2017;81:206-25.
90. Medicines and Healthcare products Regulatory Agency. Temozolomide 140 mg capsules. Summary of Product Characteristics. Available at: <https://products.mhra.gov.uk/product/?product=TEMOZOLOMIDE%20140MG%20CAPSULES>. 2020.
91. Office for National Statistics. Office for National Statistics (ONS), National life tables: UK. Available at: <https://www.ons.gov.uk/peoplepopulationandcommunity/birthsdeathsandmarriages/lifeexpectancies/datasets/nationallifetablesunitedkingdomreferencetables> [Last accessed: 19th August 2023]. 2023.
92. Jakacki RI, Cohen KJ, Buxton A, Krailo MD, Burger PC, Rosenblum MK, et al. Phase 2 study of concurrent radiotherapy and temozolomide followed by temozolomide and lomustine in the treatment of children with high-grade glioma: a report of the Children's Oncology Group ACNS0423 study. *Neuro Oncol*. 2016;18(10):1442-50.
93. Latimer N. NICE DSU Technical Support Document 14: Undertaking survival analysis for economic evaluations alongside clinical trials - extrapolation with patient-level data. Available at: <https://www.sheffield.ac.uk/sites/default/files/2022-02/TSD14-Survival-analysis.updated-March-2013.v2.pdf>. 2013.
94. MacDonald TJ, Vezina G, Stewart CF, Turner D, Pierson CR, Chen L, et al. Phase II study of cilengitide in the treatment of refractory or relapsed high-grade gliomas in children: a report from the Children's Oncology Group. *Neuro Oncol*. 2013;15(10):1438-44.
95. Narayana A, Kunnakkat S, Chacko-Mathew J, Gardner S, Karajannis M, Raza S, et al. Bevacizumab in recurrent high-grade pediatric gliomas. *Neuro Oncol*. 2010;12(9):985-90.
96. Garside R, Pitt M, Anderson R, et al. The effectiveness and cost-effectiveness of carmustine implants and temozolomide for the treatment of newly diagnosed high-grade glioma: a systematic review and economic evaluation. 2007. In: NIHR Health Technology Assessment programme: Executive Summaries. Southampton (UK): NIHR Journals Library; Available from: <https://www.ncbi.nlm.nih.gov/books/NBK56869/>.
97. National Institute for Health and Care Excellence (NICE). Carmustine implants and temozolomide for the treatment of newly diagnosed high-grade glioma. TA121. Available at: <https://www.nice.org.uk/guidance/ta121>. 2007.
98. National Institute for Health and Care Excellence (NICE). Pembrolizumab for treating relapsed or refractory classical Hodgkin lymphoma after stem cell transplant or at least 2 previous therapies. TA772. Committee Papers. Available at: <https://www.nice.org.uk/guidance/ta772/evidence>. 2022.
99. Jakola AS, Unsgard G, Myrnes KS, Kloster R, Torp SH, Lindal S, et al. Low grade gliomas in eloquent locations - implications for surgical strategy, survival and long term quality of life. *PLoS One*. 2012;7(12):e51450.
100. Buvarp D, Ryden I, Sunnerhagen KS, Olsson Bontell T, Gomez Vecchio T, Smits A, et al. Preoperative Patient-Reported Outcomes in Suspected Low-Grade Glioma: Markers of Disease Severity and Correlations with Molecular Subtypes. *J Clin Med*. 2021;10(4).
101. Janssen MF, Szende A, Cabases J, Ramos-Goni JM, Vilagut G, Konig HH. Population norms for the EQ-5D-3L: a cross-country analysis of population surveys for 20 countries. *Eur J Health Econ*. 2019;20(2):205-16.
102. National Institute for Health and Care Excellence (NICE). EGFR-TK mutation testing in adults with locally advanced or metastatic non-small-cell lung cancer. DG9. Available at: <https://www.nice.org.uk/guidance/dg9>. 2013.
103. National Institute for Health and Care Excellence (NICE). Eliglustat for treating type 1 Gaucher disease. HST5. Available at: <https://www.nice.org.uk/guidance/hst5>. 2017.

Dabrafenib with trametinib for treating *BRAF* V600E mutation-positive glioma in children and young people aged 1 to 17

104. Hadi M, Swinburn P, Nalysnyk L, Hamed A, Mehta A. A health state utility valuation study to assess the impact of treatment mode of administration in Gaucher disease. *Orphanet J Rare Dis*. 2018;13(1):159.
105. Matza LS, Cong Z, Chung K, Stopeck A, Tonkin K, Brown J, et al. Utilities associated with subcutaneous injections and intravenous infusions for treatment of patients with bone metastases. *Patient Prefer Adherence*. 2013;7:855-65.
106. National Health Service. 2021/2022 National Cost Collection Guidance. Volume 3: National Cost Collection – acute, mental health, improving access to psychological therapies and community services. Version 1, March 2022. Available at: https://www.england.nhs.uk/wp-content/uploads/2021/03/1304_NCC_vol3_v1_mar22.pdf. 2022.
107. Department of Health. National Proton Beam Therapy Service Development Programme Value for Money Addendum to Strategic Outline Case. Available at: https://assets.publishing.service.gov.uk/government/uploads/system/uploads/attachment_data/file/213045/national-proton-beam-therapy-service-development-programme-value-for-money-addendum.pdf [last accessed: 10th August 2023]. 2012.
108. National Health Service England. Clinical Commissioning Policy: Proton Beam Therapy for Children, Teenagers and Young Adults in the treatment of malignant and nonmalignant tumours. NHS England Reference: 200808P. Available at: <https://www.england.nhs.uk/wp-content/uploads/2020/10/proton-beam-therapy-clinical-commissioning-policy.pdf> [last accessed: 10th august 2023]. 2020.
109. Scottish Medicines Consortium. Temozolomide 5, 20, 100 and 250mg capsules (Temodal®). SMC ID: 244/06. Available at: <https://www.scottishmedicines.org.uk/medicines-advice/temozolomide-5-20-100-and-250mg-capsules-temodal-fullsubmission-24406/>. 2006.
110. Catt SL, Anderson JL, Chalmers AJ, Fallowfield LJ. A UK-wide survey of follow-up practices for patients with high-grade glioma treated with radical intent. *Journal of Evaluation in Clinical Practice*. 2011;17(1):1-6.
111. Georghiou T, Bardsley M. Nuffield Trust. Exploring the cost of care at the end of life. Available at: <https://www.nuffieldtrust.org.uk/sites/default/files/2017-01/end-of-life-care-web-final.pdf>. 2014.
112. Ryall S, Zapotocky M, Fukuoka K, Nobre L, Guerreiro Stucklin A, Bennett J, et al. Integrated Molecular and Clinical Analysis of 1,000 Pediatric Low-Grade Gliomas. *Cancer Cell*. 2020;37(4):569-83.e5.

Summary of Information for Patients (SIP): The pharmaceutical company perspective

What is the SIP?

The Summary of Information for Patients (SIP) is written by the company who is seeking approval from NICE for their treatment to be sold to the NHS for use in England. It's a plain English summary of their submission written for patients participating in the evaluation. It's not independently checked, although members of the public involvement team at NICE will have read it to double-check for marketing and promotional content before it's sent to you.

The Summary of Information for Patients template has been adapted for use at NICE from the [Health Technology Assessment International – Patient & Citizens Involvement Group](#) (HTAi PCIG). Information about the development is available in an open-access [IJTAHC journal article](#).

Section 1: submission summary

1a) Name of the medicine

Both generic and brand name.

Dabrafenib (Finlee®) plus trametinib (Spexotras®)

1b) Population this treatment will be used by

Please outline the main patient population that is being appraised by NICE:

Children and young people with *BRAF* V600E mutation-positive glioma:

- Low-grade glioma that requires systemic treatment
- High-grade glioma that has relapsed, progressed or failed to respond to previous systemic treatment

1c) Authorisation

Please provide marketing authorisation information, date of approval and link to the regulatory agency approval. If the marketing authorisation is pending, please state this, and reference the section of the company submission with the anticipated dates for approval.

A marketing authorisation application for dabrafenib (Finlee®) and trametinib (Spexotras®) in this indication was submitted to the EMA in September 2022; a positive opinion from the CHMP is anticipated in Q3 2023, and the anticipated date of EMA approval is Q4 2023. MHRA approval is expected in Q4 2023.

1d) Disclosures

Please be transparent about any existing collaborations (or broader conflicts of interest) between the pharmaceutical company and patient groups relevant to the medicine. Please outline the reason and purpose for the engagement/activity and any financial support provided:

Not applicable.

Section 2: current landscape

2a) The condition – clinical presentation and impact

Please provide a few sentences to describe the condition that is being assessed by NICE and the number of people who are currently living with this condition in England.

Please outline in general terms how the condition affects the quality of life of patients and their families/caregivers. Please highlight any mortality/morbidity data relating to the condition if available. If the company is making a case for the impact of the treatment on carers this should be clearly stated and explained.

Condition that the medicine treats

Gliomas are the most common type of brain cancer in paediatric patients (children and young people) (1). Paediatric gliomas can be divided into two types: low-grade (LGG) or high-grade glioma (HGG) (2). Paediatric LGGs are more common than HGGs, and overall, carry a better prognosis (3, 4). However, the presence a specific mutation in the v-raf murine sarcoma viral oncogene homolog B (BRAF) gene (*BRAF* V600E mutation) is associated with a poor prognosis (3, 5, 6) and poor outcomes, even after treatment with conventional therapies (5). *BRAF* V600E mutations are associated with an increased risk of transformation of LGG tumours to the more aggressive HGG type (7). High-grade gliomas are less frequent, however carry a greater risk of mortality, accounting for over 40% of cancer-related deaths in children (8).

In the United Kingdom (UK), there are about 150 cases of paediatric LGG, and just under 30 cases of paediatric HGG diagnosed per year (9, 10).

What is the impact of glioma on a person's quality of life?

Brain tumours pose a significant burden on the quality of life (QoL) of patients, who experience poor physical health, decreased mental health, emotional functioning, and social functioning (11). Symptoms of paediatric glioma include nausea and vomiting, lethargy, irritability, headaches, clumsiness, seizures, changes in personality and behaviour, and abnormal gait (9, 10). Additionally, children with LGG display greater anxiety and depression compared with children diagnosed with other brain cancers (12). As adults, survivors of childhood brain cancers are at an increased risk of unemployment, being unable to drive, cognitive, motor, and psychological-emotional impairments (11).

Brain tumours are associated with long-term ill health and are responsible for the greatest loss in potential life-years (calculated as the difference between age of death and the average life expectancy for a person of the same age, race, and ethnicity) in children and adolescents (13). Surgery, radiation, and chemotherapy may lead to complications and treatment-associated side-effects such as fatigue, anorexia, blood clots, gastrointestinal perforation, and bone marrow suppression. Depressive symptoms and fatigue are associated with an increase in healthcare utilisation and reduced work productivity (14).

2b) Diagnosis of the condition (in relation to the medicine being evaluated)

Please briefly explain how the condition is currently diagnosed and how this impacts patients. Are there any additional diagnostic tests required with the new treatment?

How is paediatric glioma diagnosed?

Paediatric brain tumours can remain undiagnosed for a prolonged period of time (3). Patients in these age groups are not always capable to effectively describe their symptoms, and common non-specific symptoms, such as headaches, can easily be missed. The main method for diagnosing paediatric gliomas is imaging, which mainly includes computed tomography (CT) and magnetic resonance imaging (MRI), and also newer imaging techniques such as functional MRI (fMRI) and positron emission tomography (PET) (3).

In England, patients diagnosed with gliomas are routinely tested for common mutations, including *BRAF* V600 mutations, so the new treatment does not require any additional diagnostic tests.

2c) Current treatment options:

The purpose of this section is to set the scene on how the condition is currently managed:

- What is the treatment pathway for this condition and where in this pathway the medicine is likely to be used? Please use diagrams to accompany text where possible. Please give emphasis to the specific setting and condition being considered by NICE in this review. For example, by referencing current treatment guidelines. It may be relevant to show the treatments people may have before and after the treatment under consideration in this SIP.
- Please also consider:

- if there are multiple treatment options, and data suggest that some are more commonly used than others in the setting and condition being considered in this SIP, please report these data.
- are there any drug–drug interactions and/or contraindications that commonly cause challenges for patient populations? If so, please explain what these are.

About 40% of paediatric patients with LGG can be cured with surgery alone, but the majority will require systemic treatment (e.g. chemotherapy or targeted therapy than can be administered via injection, infusion or oral medication) as part of their treatment pathway. Current guidelines from the Children’s Cancer and Leukaemia Group (CCLG) recommend radiotherapy and/or chemotherapy with vincristine and carboplatin as the first line of chemotherapy, and vinblastine as a second-line chemotherapy (3).

There are no specific guidelines for the treatment of paediatric HGG; the current standard-of-care (SoC) therapy is radiation therapy and where possible, surgical removal of the tumour (15). There is no standard chemotherapy that is universally acknowledged in the setting of HGG for children and young adults (16). Currently, temozolomide (TMZ) is the only chemotherapy approved for treating patients with relapsed (tumour recurrence after treatment) or refractory (not responding to treatment) HGG (17); however, trials evaluating TMZ in paediatric patients had poor response rates to therapy, ranging from 0–25% (18–23).

Dabrafenib in combination with trametinib is indicated for the treatment of paediatric patients aged 1 year and older with:

- LGG with a *BRAF* V600E mutation which requires systemic therapy
- HGG with a *BRAF* V600E mutation previously treated with at least one prior radiation and/or chemotherapy treatment.

2d) Patient-based evidence (PBE) about living with the condition

Context:

- **Patient-based evidence (PBE)** is when patients input into scientific research, specifically to provide experiences of their symptoms, needs, perceptions, quality of life issues or experiences of the medicine they are currently taking. PBE might also include carer burden and outputs from patient preference studies, when conducted in order to show what matters most to patients and carers and where their greatest needs are. Such research can inform the selection of patient-relevant endpoints in clinical trials.

In this section, please provide a summary of any PBE that has been collected or published to demonstrate what is understood about **patient needs and disease experiences**. Please include the methods used for collecting this evidence. Any such evidence included in the SIP should be formally referenced wherever possible and references included.

The symptoms associated with glioma have a significant impact on the quality of life of patients and their carers. However, there are limited studies to date that have investigated what is important to patients with regard to their treatment.

A study focussing on the health related quality of life (HRQoL) and the impact of treatment on HRQoL in long term survivors of paediatric LGG has been published. A measure called

the European Organization for Research and Treatment of Cancer Quality of Life Questionnaire was used to determine the quality of life of patients. The study showed that patients who received prior radiation therapy reported lower physical functioning and role functioning, with more constipation symptoms. Furthermore, it highlighted that patients who had tumour recurrence had lower role and social functioning and increased financial problems (24).

The Children's Oncology Group L991 study reported on behavioural, neuropsychological, and quality of life outcomes in patients with HGG; these were assessed via standardised tests. The study demonstrated intellectual functioning was in the low-average range, while executive functioning and verbal memory were in the low-average range. The study reported borderline ranges with visual memory, and between borderline and impaired ranges in psychomotor processing speed (25).

A retrospective (historical patient cohort) study in stable glioma patients focussing on frequency and burden of 17 symptoms on a seven-point Likert scale reported that the top five symptoms reported were fatigue, memory issues, reduced physical fitness, concentration, and drowsiness. Over 50% of patients experienced three or more symptoms simultaneously (26).

A study of 50 children who were followed up after brain tumour treatment reported that the median number of symptoms was six, and the most common symptoms were fatigue, drowsiness, poor sleep, lack of concentration, and headaches. The most distressing symptoms reported were pain, headaches, fatigue, and poor sleep (27).

Overall, these studies highlight the importance in the need of treatments to reduce symptom burden and improve QOL in the short and long term.

Section 3: the treatment

3a) How does the new treatment work? What are the important features of this treatment?

Please outline as clearly as possible important details that you consider relevant to patients relating to the mechanism of action and how the medicine interacts with the body

Where possible, please describe how you feel the medicine is innovative or novel, and how this might be important to patients and their communities.

If there are relevant documents which have been produced to support your regulatory submission such as a summary of product characteristics or patient information leaflet, please provide a link to these.

Dabrafenib and trametinib are targeted drugs that inhibit cancer growth. Dabrafenib targets the protein BRAF, with 5–10-fold greater potency for inhibiting its mutant form (BRAF V600), thereby preventing proliferation (increasing numbers) of cancer cells with a *BRAF* V600 mutation, and ultimately kills the tumour cells. Trametinib inhibits the MEK1 and MEK2 proteins, thereby preventing tumour growth. Since both BRAF and MEK act within the same biological pathway, inhibiting both proteins simultaneously rather than individually is expected to provide improved efficacy, as well as address resistance to a BRAF or MEK inhibitor alone (28, 29).

Dabrafenib and trametinib already have marketing authorisation in the UK, as monotherapies or as a combination therapy for the treatment of melanoma or non-small cell lung cancer with a *BRAF* V600 mutation.

Dabrafenib and trametinib are both given orally, and therefore can be taken at home. Both drugs represent a more convenient, less painful, and less burdensome method of administration compared with chemotherapy, which must be administered via an intravenous (IV) infusion and requires patients to attend a hospital appointment in order to receive treatment.

3b) Combinations with other medicines

Is the medicine intended to be used in combination with any other medicines?

Yes – Dabrafenib and trametinib are to be used in combination, however, are not indicated to be used with any other medicines

No

If yes, please explain why and how the medicines work together. Please outline the mechanism of action of those other medicines so it is clear to patients why they are used together.

If yes, please also provide information on the availability of the other medicine(s) as well as the main side effects.

If this submission is for a combination treatment, please ensure the sections on efficacy (3e), quality of life (3f) and safety/side effects (3g) focus on data that relate to the combination, rather than the individual treatments.

The submission focusses on the combination of dabrafenib and trametinib for the treatment of paediatric LGG and HGG.

Both dabrafenib and trametinib inhibit proteins that act within the same cell signalling pathway (MAPK signalling pathway), which is involved in controlling cell growth, proliferation, and cell survival (BRAF and MEK). Since both BRAF and MEK act within the same biological pathway, inhibiting both proteins at the same time rather than individually is expected to provide improved anti-tumour effects, as well as address resistance to a BRAF or MEK inhibitor alone (28, 29).

3c) Administration and dosing

How and where is the treatment given or taken? Please include the dose, how often the treatment should be given/taken, and how long the treatment should be given/taken for.

How will this administration method or dosing potentially affect patients and caregivers? How does this differ to existing treatments?

Dabrafenib plus trametinib (liquid formulations), are administered orally and are dosed based on weight:

- Dabrafenib paediatric oral suspension formulation (10 mg dispersible tablets for oral suspension) is administered using a dosing cup and/or graduated syringe. Patients are encouraged to take dabrafenib at approximately 12-hour intervals and at similar times each day
- Trametinib paediatric oral solution formulation (5.0 mg powder for oral solution reconstituted to 0.05 mg/mL with 90 mL water) is to be administered with a graduated syringe. Trametinib is to be taken in combination with dabrafenib once daily, preferably in the morning.

3d) Current clinical trials

Please provide a list of completed or ongoing clinical trials for the treatment. Please provide a brief top-level summary for each trial, such as title/name, location, population, patient group size, comparators, key inclusion and exclusion criteria and completion dates etc. Please provide references to further information about the trials or publications from the trials.

The clinical efficacy (how well the treatment works) and safety of dabrafenib in combination with trametinib was studied in the TADPOLE study (NCT02684058), a Phase 2, open-label, global trial conducted in paediatric patients with *BRAF* V600E mutation-positive LGG or relapsed or refractory HGG (30). The study was completed on the 28th April 2023.

The safety and efficacy of dabrafenib and trametinib in paediatric patients with relapsed/refractory *BRAF* V600E mutation-positive LGG were also investigated in a four-part, multi-centre, open label Phase 1/2 study (NCT02124772), which completed on 29th December 2020 (31, 32).

TADPOLE - LGG cohort

The LGG cohort was a multicentre, randomised, open-label part of the TADPOLE study, conducted in children and adolescents with *BRAF* V600E mutation-positive progressing LGG, whose tumour was unresectable and required treatment. In the LGG cohort, 73 patients were randomised to receive dabrafenib + trametinib (D+T) and 37 patients

received a chemotherapy comparator, carboplatin plus vincristine (C+V). To be included in the study, patients needed to have progressive disease following surgical excision, or be non-surgical candidates with necessity to begin first systemic treatment because of a risk of neurological impairment with progression. Patients previously treated with any anti-cancer systemic therapy or investigational drugs were excluded from the study.

TADPOLE - HGG cohort

The HGG cohort was a multicentre, single-arm, open-label part of the TADPOLE study, conducted in children and adolescent patients with *BRAF* V600E mutation-positive refractory or relapsed HGG tumours after receiving at least one previous therapy. In the HGG cohort, 41 patients received D+T. To be included in the study, patients needed to have relapsed, progressed, or failed to respond to frontline therapy. They also needed to have stopped any previous anti-cancer systemic therapy or investigational drugs three weeks before receiving the first dose of D+T.

Phase 1/2 study in *BRAF* mutation-positive relapsed/refractory paediatric LGG

Study NCT02124772 was a Phase 1/2, multicentre, open-label study with four parts:

- Part A enrolled patients with solid tumours (i.e. *BRAF* V600 mutation was not required)
- Part B included expansion cohorts for neuroblastoma, *BRAF*-fusion LGG, neurofibromatosis type 1-associated plexiform neurofibroma, and *BRAF* V600-mutant tumours
- In parts C and D, patients had *BRAF* V600-mutant disease; disease-specific expansion cohorts in Part D included LGG and Langerhans cell histiocytosis

In parts C and D, 36 patients with *BRAF* V600-mutant LGG received D+T. To be included in the study, patients needed to have relapsed/refractory malignancies that had exhausted any potentially curative treatments including surgery, radiation, chemotherapy, or combination thereof.

3e) Efficacy

Efficacy is the measure of how well a treatment works in treating a specific condition.

In this section, please summarise all data that demonstrate how effective the treatment is compared with current treatments at treating the condition outlined in section 2a.

- Are any of the outcomes more important to patients than others and why?
- Are there any limitations to the data which may affect how to interpret the results?

Please do not include academic or commercial in confidence information but where necessary reference the section of the company submission where this can be found.

TADPOLE

Treatment with D+T resulted in a clinically meaningful benefit in overall response rate (ORR; the percentage of patients whose cancer shrinks or disappears after treatment) in both LGG and HGG cohorts of the TADPOLE study (Section B.2.6.2).

LGG cohort

In the LGG cohort, more patients responded to treatment in the D+T arm compared with the chemotherapy arm, as assessed by independent review (review from radiographers who are independent from the study). Responses were durable. D+T reduced the risk of death or disease progression compared with those treated with chemotherapy.

HGG cohort

In the HGG cohort, D+T was associated with clinically meaningful response rate. Similarly to the LGG cohort, responses were durable. The risk of death or progression was lower compared with historical cohort.

Phase 1/2 study

In parts C and D of the Phase 1/2 study, patients treated with D+T experienced a clinically meaningful response. Responses were durable. The risk of death or progression was lower compared with historical cohort.

3f) Quality of life impact of the medicine and patient preference information

What is the clinical evidence for a potential impact of this medicine on the quality of life of patients and their families/caregivers? What quality of life instrument was used? If the EuroQol-5D (EQ-5D) was used does it sufficiently capture quality of life for this condition? Are there other disease specific quality of life measures that should also be considered as supplementary information?

Please outline in plain language any quality of life related data such as patient reported outcomes (PROs).

Please include any patient preference information (PPI) relating to the drug profile, for instance research to understand willingness to accept the risk of side effects given the added benefit of treatment. Please include all references as required.

In the TADPOLE study (LGG cohort), the Patient Reported Outcomes Measurement Information Service (PROMIS) Parent Proxy Global Health 7+2 was used to evaluate the QoL of patients between the two treatment arms. A higher score for global health indicates better overall wellbeing (i.e. physical, mental, and social health); a higher score for pain and fatigue indicates worsening pain and fatigue.

Among patients taking the PROMIS questionnaire, there was a trend in improvement in global health scores and fatigue scores for the D+T arm compared with the C+V arm. The difference in scores between the two treatment groups for global health and fatigue were also in favour of the D+T arm over the C+V arm, at all scheduled time points.

3g) Safety of the medicine and side effects

When NICE appraises a treatment, it will pay close attention to the balance of the benefits of the treatment in relation to its potential risks and any side effects. Therefore, please outline the main side effects (as opposed to a complete list) of this treatment and include details of a benefit/risk assessment where possible. This will support patient reviewers to consider the potential overall benefits and side effects that the medicine can offer.

Based on available data, please outline the most common side effects, how frequently they happen compared with standard treatment, how they could

potentially be managed and how many people had treatment adjustments or stopped treatment. Where it will add value or context for patient readers, please include references to the Summary of Product Characteristics from regulatory agencies etc.

In TADPOLE, the overall safety profile of D+T was consistent with the safety profile observed in adult patients in approved indications.

In the LGG cohort, the most common side effects related to treatment reported in patients treated with D+T were fever, vomiting, and nausea. There were considerably more serious side effects in patients treated with chemotherapies than those treated with D+T. More patients stopped treatment because of side effects from chemotherapy treatment than D+T treatment.

In the HGG cohort, the most common side effects were fever, dry skin and rash.

3h) Summary of key benefits of treatment for patients

Issues to consider in your response:

- Please outline what you feel are the key benefits of the treatment for patients, caregivers and their communities when compared with current treatments.
- Please include benefits related to the mode of action, effectiveness, safety and mode of administration

In paediatric glioma, the key benefits of treatment with D+T are:

- Clinically meaningful and durable responses in both LGG and HGG
- In patients with LGG, D+T was associated with a significantly lower risk of death or disease progression compared with standard chemotherapy
- Fewer serious side effects than treatment with standard chemotherapy
- A more convenient, less painful mode of administration, compared with IV chemotherapy, avoiding hospital visits

3i) Summary of key disadvantages of treatment for patients

Issues to consider in your response:

- Please outline what you feel are the key disadvantages of the treatment for patients, caregivers and their communities when compared with current treatments. Which disadvantages are most important to patients and carers?
- Please include disadvantages related to the mode of action, effectiveness, side effects and mode of administration
- What is the impact of any disadvantages highlighted compared with current treatments

All medicines have the potential to cause side effects. There are still some side effects that might be experienced by patients who take this new medicine.

The side effects that patients taking this new medicine may experience are described above in Section 3g and are considered manageable by clinicians. There are fewer serious side effects reported with dabrafenib plus trametinib than with standard chemotherapy.

3j) Value and economic considerations

Introduction for patients:

Health services want to get the most value from their budget and therefore need to decide whether a new treatment provides good value compared with other treatments. To do this they consider the costs of treating patients and how patients' health will improve, from feeling better and/or living longer, compared with the treatments already in use. The drug manufacturer provides this information, often presented using a health economic model.

In completing your input to the NICE appraisal process for the medicine, you may wish to reflect on:

- The extent to which you agree/disagree with the value arguments presented below (e.g., whether you feel these are the relevant health outcomes, addressing the unmet needs and issues faced by patients; were any improvements that would be important to you missed out, not tested or not proven?)
- If you feel the benefits or side effects of the medicine, including how and when it is given or taken, would have positive or negative financial implications for patients or their families (e.g., travel costs, time-off work)?
- How the condition, taking the new treatment compared with current treatments affects your quality of life.

How the model reflects the condition

Treatment of LGG and HGG were modelled to estimate the impact of treatment on the progression of the disease over the lifetime of patients, and to calculate the overall costs associated with treatment using current SoC therapy or D+T. Outcomes were measured as quality adjusted life-years (QALYs), a measure which weights longevity according to QoL and reflects the impact of treatment on both life expectancy and QoL.

Current SoC for patients with LGG is vincristine with carboplatin. Current SoC for patients with HGG is radiotherapy and temozolomide (TMZ). The model considered two groups of patients with HGG, those who had already received TMZ, and those who had not. The comparator was TMZ for patients with HGG who had not previously received this treatment. Patients with HGG previously treated with TMZ and receiving D+T were compared to patients receiving best supportive care (BSC).

The model of HGG included three states: one for the disease prior to progression; one for the disease after progression; and one for death. This structure is very commonly used to model advanced cancers. The model of LGG included nine states: one for the disease before progression; five sequential post-progression health states; two states to capture malignant transformation of the disease (a development that leads to rapid disease progression); and death. The model of LGG reflected the long-term nature of the disease

and the potential for several interventions over the lifetime of the patient if and when the cancer progresses.

The model simulated 2,000 patients with characteristics similar to those in the TADPOLE trial and estimated costs and QALYs if the patient was treated with D+T, and if the patient was treated with current SoC. Average (mean) costs and QALYs with D+T and with SoC were then compared across the simulations to estimate the additional costs of patient health care arising from treatment with D+T, and the additional QALYs. The incremental cost-effectiveness ratio (ICER) was reported as the additional costs for D+T, divided by the additional QALYs. The ICER is the basic measure of the cost-effectiveness or value for money of D+T. Separate ICERs were estimated for patients with LGG, for patients with HGG with no prior TMZ treatment, and for patients with previously treated HGG.

Modelling how treatment extends life

- D+T is more effective compared with SoC in preventing disease progression. A reduction in disease progression is likely to lead to an improvement in survival
- Data on survival following disease progression for LGG are taken from the literature and show that patients who progress early have worse outcomes compared with those who progress later
- For HGG, data on survival following disease progression were taken directly from TADPOLE and assumed to be the same irrespective of treatment received.

Modelling how much a treatment improves quality of life

- D+T leads to an improvement in patients' QoL compared with those receiving SoC. This is due to a reduction of disease progression, decrease in treatment-related side effects and patients' preference for an oral treatment
- Assessing QoL in children is challenging, and there is a lack of suitable data for glioma. Consequently, QoL data (using the EQ-5D) used in the model comes from adult patients with glioma
- Patients with HGG have a short life expectancy and NICE places a higher value on health gains for these patients. Patients with LGG experience a substantial QALY shortfall, compared with the general population. Consequently, QALYs for LGG and HGG patients were multiplied by a severity weight of 1.2 and 1.7, respectively, to reflect the severity of the disease.

Modelling how the costs of treatment differ with the new treatment

- The model shows that the total costs associated with D+T are higher compared with SoC. This is due to higher drug costs
- Resource use associated with administration, subsequent treatments, management of adverse events and the condition were lower for dabrafenib plus trametinib compared with SoC.

Uncertainty

- The key uncertainty relates to the duration of treatment assumed, estimation of progression beyond the trial, society's preference for benefits and cost to be accrued in the future and assumptions around QoL. Different assumptions are presented in the submission to reflect this uncertainty.

Cost-effectiveness results

- Cost-effectiveness results for D+T vs current clinical management can be found in Section B.3.9 of the Company Submission
- In summary, across all different analyses, D+T was associated with an improvement in survival (10.26 years for patients with LGG and between 1.9 to 4.6 years for patients with HGG depending on whether they were pre-treated with TMZ or not) and improvement in QoL
- ICERs were below currently accepted thresholds.

Additional factors

Both dabrafenib and trametinib are oral therapies, unlike chemotherapies. In addition to the discomfort of receiving regular IV treatment, oral therapies avoid the need for regular hospital attendance with the concomitant risk of SARS-CoV-2 infection. The replacement of a treatment requiring regular hospital attendance with an oral therapy also reduces pressure on currently overstretched hospital services. The benefits in QoL for carers are also substantial but are difficult to capture in the QALY calculation. These additional benefits of D+T have not been formally included in the economic analysis.

3k) Innovation

NICE considers how innovative a new treatment is when making its recommendations.

If the company considers the new treatment to be innovative please explain how it represents a 'step change' in treatment and/ or effectiveness compared with current treatments. Are there any QALY benefits that have not been captured in the economic model that also need to be considered (see section 3f)

Dabrafenib with trametinib target proteins which act upon the same cell signalling pathway; therefore, inhibiting both proteins, BRAF and MEK, simultaneously rather than individually can overcome resistance mechanisms observed when only one protein is inhibited by a treatment.

Despite gliomas being a rare condition, dabrafenib (Finley®) and trametinib (Spexotras®) were specifically developed for paediatric patients with glioma as young children are unable to swallow tablets/capsules and may improve tolerability amongst older children.

Both dabrafenib and trametinib are administered orally, compared with SoC chemotherapies, like carboplatin and vincristine, which are administered intravenously. Dabrafenib with trametinib addresses the unmet need for a more convenient therapy for paediatric patients with glioma, improving QoL.

The availability of oral treatments has a positive impact on NHS capacity, through a reduction in the number of patients requiring IV chemotherapy. Avoiding hospital visits also reduces the financial and administrative strain on NHS capacity and has a positive impact on patient and carer QoL, as both may experience decreased anxiety and stress.

3l) Equalities

Are there any potential equality issues that should be taken into account when considering this condition and this treatment? Please explain if you think any groups of people with this condition are particularly disadvantaged.

Equality legislation includes people of a particular age, disability, gender reassignment, marriage and civil partnership, pregnancy and maternity, race, religion or belief, sex, and sexual orientation or people with any other shared characteristics

More information on how NICE deals with equalities issues can be found in the NICE equality scheme

Find more general information about the Equality Act and equalities issues here

Not applicable.

SECTION 4: Further information, glossary and references

4a) Further information

Feedback suggests that patients would appreciate links to other information sources and tools that can help them easily locate relevant background information and facilitate their effective contribution to the NICE assessment process. Please provide links to any relevant online information that would be useful, for example, published clinical trial data, factual web content, educational materials etc. Where possible, please provide open access materials or provide copies that patients can access.

Further information on paediatric glioma and guidelines:

- The Royal Marsden NHS Foundation trust. Low-grade glioma
<https://www.royalmarsden.nhs.uk/your-care/cancer-types/paediatric-cancers/low-grade-glioma>
- The Royal Marsden NHS Foundation trust. High-grade glioma
<https://www.royalmarsden.nhs.uk/your-care/cancer-types/paediatric-cancers/high-grade-glioma>
- Children's Cancer and Leukaemia Group (CCLG). Guidelines for the diagnosis and management of paediatric and adolescent Low-Grade Glioma
https://www.cclg.org.uk/write/MediaUploads/Member%20area/Treatment%20guidelines/LGG_Guidelines_July_2020.pdf

Further information on NICE and the role of patients:

- Public Involvement at NICE [Public involvement | NICE and the public | NICE Communities | About | NICE](#)
- NICE's guides and templates for patient involvement in HTAs [Guides to developing our guidance | Help us develop guidance | Support for voluntary and community sector \(VCS\) organisations | Public involvement | NICE and the public | NICE Communities | About | NICE](#)
- EFPIA – Working together with patient groups:
<https://www.efpia.eu/media/288492/working-together-with-patient-groups-23102017.pdf>
- National Health Council Value Initiative:
<https://nationalhealthcouncil.org/issue/value/>
- The International Network of Agencies for Health Technology Assessment – INAHTA: <http://www.inahta.org/>

4b) Glossary of terms

Clinical trial/clinical study: A type of research study that tests how well new medical approaches work in people. These studies test new methods of screening, prevention, diagnosis, or treatment of a disease.

Disutility: Represents the decrement in utility (valued quality of life) due to a particular symptom or complication.

Duration of response (DOR): The length of time that a tumour continues to respond to treatment without the cancer growing or spreading

Incremental cost-effectiveness ratio (ICER): The ICER is the difference in the change in mean costs in the population of interest divided by the difference in the change in mean outcomes in the population of interest.

Intravenous: A medical technique that administers fluids, medications, and nutrients into a person's vein.

Mean: In statistics, the mean or average is the sum of numbers divided by the number of numbers. E.g. from adding the following seven numbers together and dividing by seven, the mean is 5.3: $1+3+3+6+7+8+9=37.7$; $37.7/7=5.3$.

Median: In statistics, the median is the value separating the higher half from the lower half of a data sample. E.g. out of the following numbers, 6 is the median: 1, 3, 3, 6, 7, 8, 9.

NICE: The National Institute for Health and Care Excellence. It is an independent organisation set up by the Government to decide which drugs and treatments are available on the NHS in England.

Overall response rate (ORR): The total number of patients whose cancer has either gone away (a complete response) or shrunk (a partial response).

Progression-free survival (PFS): The length of time from the start of treatment to the occurrence of disease progression or death.

Patient Reported Outcomes Measurement Information Service (PROMIS): A set of person-centered measures that evaluates and monitors physical, mental, and social health in adults and children.

Quality of life (QoL): A measure of the overall enjoyment and happiness of life including aspects of an individual's sense of well-being and ability to carry out activities of daily living.

Quality-adjusted life years (QALYs): QALYs are an overall measure of health outcome that weight the life expectancy of a patient with an estimate of their HRQoL (measured on a 0–1 scale).

Standard-of-care (SoC): Treatment that is accepted and widely used by medical experts and healthcare professionals for a certain type of disease.

4c) References

Please provide a list of all references in the Vancouver style, numbered and ordered strictly in accordance with their numbering in the text:

1. Ostrom QT, Gittleman H, Fulop J, Liu M, Blanda R, Kromer C, et al. CBTRUS Statistical Report: Primary Brain and Central Nervous System Tumors Diagnosed in the United States in 2008-2012. *Neuro Oncol.* 2015;17 Suppl 4(Suppl 4):iv1-iv62.
2. Louis DN, Perry A, Wesseling P, Brat DJ, Cree IA, Figarella-Branger D, et al. The 2021 WHO Classification of Tumors of the Central Nervous System: a summary. *Neuro Oncol.* 2021;23(8):1231-51.
3. Blionas A, Giakoumettis D, Klonou A, Neromyliotis E, Karydakis P, Themistocleous MS. Paediatric gliomas: diagnosis, molecular biology and management. *Ann Transl Med.* 2018;6(12):251.
4. Brain Tumour Research. Glioma. Available at: <https://www.braintumourresearch.org/info-support/types-of-brain-tumour/glioma> (Accessed June 2023). 2023.

5. Lassaletta A, Zapotocky M, Mistry M, Ramaswamy V, Honnorat M, Krishnatry R, et al. Therapeutic and Prognostic Implications of BRAF V600E in Pediatric Low-Grade Gliomas. *J Clin Oncol*. 2017;35(25):2934-41.
6. Nobre L, Zapotocky M, Ramaswamy V, Ryall S, Bennett J, Alderete D, et al. Outcomes of BRAF V600E Pediatric Gliomas Treated With Targeted BRAF Inhibition. *JCO Precision Oncology*. 2020(4):561-71.
7. Mistry M, Zhukova N, Merico D, Rakopoulos P, Krishnatry R, Shago M, et al. BRAF mutation and CDKN2A deletion define a clinically distinct subgroup of childhood secondary high-grade glioma. *J Clin Oncol*. 2015;33(9):1015-22.
8. Ostrom QT, de Blank PM, Kruchko C, Petersen CM, Liao P, Finlay JL, et al. Alex's Lemonade Stand Foundation Infant and Childhood Primary Brain and Central Nervous System Tumors Diagnosed in the United States in 2007-2011. *Neuro Oncol*. 2015;16 Suppl 10(Suppl 10):x1-x36.
9. The Royal Marsden NHS Foundation Trust. Low-grade glioma. Available at: <https://www.royalmarsden.nhs.uk/your-care/cancer-types/paediatric-cancers/low-grade-glioma> (Accessed June 2023). 2023.
10. The Royal Marsden NHS Foundation Trust. High grade glioma. Available at: <https://www.royalmarsden.nhs.uk/your-care/cancer-types/paediatric-cancers/high-grade-glioma> (Accessed June 2023). 2023.
11. Bhat SR, Goodwin TL, Burwinkle TM, Lansdale MF, Dahl GV, Huhn SL, et al. Profile of daily life in children with brain tumors: an assessment of health-related quality of life. *J Clin Oncol*. 2005;23(24):5493-500.
12. Desjardins L, Barrera M, Schulte F, Chung J, Cataudella D, Janzen L, et al. Predicting social withdrawal, anxiety and depression symptoms in pediatric brain tumor survivors. *J Psychosoc Oncol*. 2019;37(1):22-36.
13. de Blank PM, Ostrom QT, Rouse C, Wolinsky Y, Kruchko C, Salcido J, et al. Years of life lived with disease and years of potential life lost in children who die of cancer in the United States, 2009. *Cancer Med*. 2015;4(4):608-19.
14. Kristiansen I, Strinnholm M, Strömberg B, Frisk P. Clinical characteristics, long-term complications and health-related quality of life (HRQoL) in children and young adults treated for low-grade astrocytoma in the posterior fossa in childhood. *J Neurooncol*. 2019;142(1):203-10.
15. Chatwin HV, Cruz Cruz J, Green AL. Pediatric high-grade glioma: moving toward subtype-specific multimodal therapy. *Febs j*. 2021;288(21):6127-41.
16. MacDonald TJ, Aguilera D, Kramm CM. Treatment of high-grade glioma in children and adolescents. *Neuro Oncol*. 2011;13(10):1049-58.
17. European Medicines Agency. Temozolomide. Summary of product characteristics (last updated 17 December 2008). Available at: https://www.ema.europa.eu/en/documents/product-information/temodal-epar-product-information_en.pdf (Accessed August 2023). 2008.
18. Lashford LS, Thiesse P, Jouvet A, Jaspan T, Couanet D, Griffiths PD, et al. Temozolomide in malignant gliomas of childhood: a United Kingdom Children's Cancer Study Group and French Society for Pediatric Oncology Intergroup Study. *J Clin Oncol*. 2002;20(24):4684-91.

19. Le Teuff G, Castaneda-Heredia A, Dufour C, Jaspan T, Calmon R, Devos A, et al. Phase II study of temozolomide and topotecan (TOTEM) in children with relapsed or refractory extracranial and central nervous system tumors including medulloblastoma with post hoc Bayesian analysis: A European ITCC study. *Pediatr Blood Cancer*. 2020;67(1):e28032.
20. Nicholson HS, Kretschmar CS, Krailo M, Bernstein M, Kadota R, Fort D, et al. Phase 2 study of temozolomide in children and adolescents with recurrent central nervous system tumors: a report from the Children's Oncology Group. *Cancer*. 2007;110(7):1542-50.
21. Ruggiero A, Cefalo G, Garre ML, Massimino M, Colosimo C, Attina G, et al. Phase II trial of temozolomide in children with recurrent high-grade glioma. *J Neurooncol*. 2006;77(1):89-94.
22. Verschuur AC, Grill J, Lelouch-Tubiana A, Couanet D, Kalifa C, Vassal G. Temozolomide in paediatric high-grade glioma: a key for combination therapy? *Br J Cancer*. 2004;91(3):425-9.
23. Warren KE, Gururangan S, Geyer JR, McLendon RE, Poussaint TY, Wallace D, et al. A phase II study of O6-benzylguanine and temozolomide in pediatric patients with recurrent or progressive high-grade gliomas and brainstem gliomas: a Pediatric Brain Tumor Consortium study. *J Neurooncol*. 2012;106(3):643-9.
24. Nwachukwu CR, Youland RS, Chioreso C, Wetjen N, NageswaraRao A, Keating G, et al. Health related quality of life (HRQOL) in long-term survivors of pediatric low grade gliomas (LGGs). *J Neurooncol*. 2015;121(3):599-607.
25. Sands SA, Zhou T, O'Neil SH, Patel SK, Allen J, McGuire Cullen P, et al. Long-term follow-up of children treated for high-grade gliomas: children's oncology group L991 final study report. *J Clin Oncol*. 2012;30(9):943-9.
26. Röttgering JG, Belgers V, Kouwenhoven MCM, Schuur M, Postma TJ, Nijboer CM, et al. Frequency and burden of potentially treatable symptoms in glioma patients with stable disease. *Heliyon* [Internet]. 2023 2023/02//; 9(2):[e13278 p.]. Available from: <http://europepmc.org/abstract/MED/36798771>
<http://www.cell.com/article/S2405844023004851/pdf>
<https://doi.org/10.1016/j.heliyon.2023.e13278>
<https://europepmc.org/articles/PMC9925977>
<https://europepmc.org/articles/PMC9925977?pdf=render>.
27. Macartney G, VanDenKerkhof E, Harrison MB, Stacey D. Symptom experience and quality of life in pediatric brain tumor survivors: a cross-sectional study. *J Pain Symptom Manage*. 2014;48(5):957-67.
28. Bowyer S, Lee R, Fusi A, Lorigan P. Dabrafenib and its use in the treatment of metastatic melanoma. *Melanoma Manag*. 2015;2(3):199-208.
29. Lugowska I, Kosela-Paterczyk H, Kozak K, Rutkowski P. Trametinib: a MEK inhibitor for management of metastatic melanoma. *Onco Targets Ther*. 2015;8:2251-9.
30. ClinicalTrials.gov. Study of Efficacy and Safety of Dabrafenib in Combination With Trametinib in Pediatric Patients With BRAF V600 Mutation Positive LGG or Relapsed or

Refractory HGG Tumors. Available at: <https://www.clinicaltrials.gov/study/NCT02684058> (Accessed September 2023). 2023.

31. ClinicalTrials.gov. Study to Investigate Safety, Pharmacokinetic (PK), Pharmacodynamic (PD) and Clinical Activity of Trametinib in Subjects With Cancer or Plexiform Neurofibromas and Trametinib in Combination With Dabrafenib in Subjects With Cancers Harboring V600 Mutations. Available at: <https://www.clinicaltrials.gov/study/NCT02124772> (Accessed July 2023). 2023.

32. Bouffet E, Geoerger B, Moertel C, Whitlock JA, Aerts I, Hargrave D, et al. Efficacy and Safety of Trametinib Monotherapy or in Combination With Dabrafenib in Pediatric BRAF V600-Mutant Low-Grade Glioma. *J Clin Oncol*. 2023;41(3):664-74.

NATIONAL INSTITUTE FOR HEALTH AND CARE EXCELLENCE

Single Technology Appraisal

Dabrafenib with trametinib for treating BRAF V600E mutation-positive glioma in children and young people aged 1 to 17 [ID5104]

Clarification questions

November 2023

File name	Version	Contains confidential information	Date
ID5104 Clarification Questions_Response_v1.0 [Redacted].docx	1.0	Yes	17 th November 2023

Section A: Clarification on effectiveness data

Literature searching

A1. Appendix D, page 8. Please provide the search strategies for the secondary review objective (broader population criterion to 'molecularly unselected patients' irrespective of mutation) for the comparative efficacy evidence for patients with relapsed or refractory HGG if they differ from section D.1. for the primary review searches (Appendix D, pages 8-15).

Novartis confirms that a single search was conducted. For the primary and secondary objectives of the review, studies were identified according to the inclusion/exclusion criteria reported in Appendix D, D.1.2 (Table 6 and Table 7).

Systematic review methods

A2. CS Appendix D, Section D.2.1, Figure 1. Please confirm if the total number of included publications is $n=46$ as $(893-850)+4 = 47$.

Please accept our apologies for the confusion. Novartis confirms that the total number of publications in Section D.2.1 is 47, not 46 publications.

A3. CS Appendix D, Table 6, page 17. Studies with fewer than 15 participants were excluded from the review. Given that BRAF V600E mutation-positive glioma is a rare disease with fewer than 30 cases of HGG being diagnosed in the UK per year.

Please justify the rationale and limitations of this approach.

A pragmatic approach was used and a sample size restriction was introduced to keep the review (for the secondary objective, e.g. studies in molecularly unselected patients) manageable. Despite this restriction, for the primary objective (e.g. BRAF V600 patients), any studies that met the inclusion criteria for the review but had a sample size less than 15 were put aside and assessed to ensure that no relevant studies were excluded based on the sample size criteria alone. Only one study by Nobre et al, 2020 was identified in patients with a *BRAF* V600E mutation (1), and was subsequently excluded because of the sample size restriction. The study reported outcomes in 11 patients with paediatric HGG treated with a *BRAF* inhibitor (dabrafenib or vemurafenib), and vemurafenib was not considered a relevant

comparator. While a limitation, Novartis believes that this was a pragmatic approach, and no relevant useable studies were excluded.

A4. CS Appendix D, Figure 1, page 21. 29 studies were excluded due to unclear type of Glioma at the full-text screening stage and 3 temozolomide (TMZ) studies were excluded due to no reporting of baseline characteristics. Please clarify if the authors were contacted to obtain information on Glioma types and baseline characteristics data? (Appendix D, Table 12, page 34)

Novartis confirms that authors were not contacted to obtain information on glioma subtype and baseline characteristics. While a potential limitation, none of these studies would have met the primary objective of the review (e.g. *BRAF* V600 patients).

A5. CS Appendix D.2.3.1, Table 9, page 25. Please could you provide further details on why Coutant 2022 was included in the table of included studies for the primary review objective but not included in any of the analysis.

While meeting the inclusion criteria for the review (primary objective), no critical appraisal of Coutant et al, 2022 was conducted as the study only included patients with Grade 1 glioma (2), and therefore was not considered relevant (despite meeting the inclusion criteria for the review), as it represented only a subset of the population of interest. In addition, the TADPOLE study includes a direct comparison against the relevant comparator for low grade glioma (LGG).

A6. CS Appendix D.2.3.1, Table 10, page 25 and Section D.5.1, Page 34. Please could you provide further details on how the 7 studies for the indirect treatment comparison (ITC) were selected?

Temozolomide (TMZ) was identified by the clinical experts to be the key chemotherapy comparator for dabrafenib with trametinib (D+T) in patients with high-grade glioma (HGG) who were not previously treated with TMZ. The seven studies considered for the ITC were selected from the clinical SLR as they reported outcomes for patients receiving TMZ. The remaining studies evaluated other chemotherapy regimens.

A7. CS Appendix D, Section D.4, Table 11, page 31-33. Please provide a narrative summary of the critical appraisal of the included studies. In addition, under the

critical appraisal section, it is stated that “*No randomised controlled trials or comparative cohort studies were identified in the review.*” However, the TADPOLE study is a randomised controlled trial. Please clarify.

The Downs and Black checklist includes a cumulative score, which ranged from 21 in Bouffet 2023 to 25 in TADPOLE. The difference in overall score was due to more thorough reporting of probability values for main outcomes, reporting of compliance data, and reporting of confounding variables in TADPOLE compared with Bouffet 2023.

Please accept our apologies for the confusion. The EAG is correct that the statement “*No randomised controlled trials or comparative cohort studies were identified in the review*” is misleading, as TADPOLE is an RCT. In the ITC, the TADPOLE study was treated as a single-arm trial in that only the dabrafenib arm was included in the analyses. Therefore, the trial was critically appraised using the Downs and Black checklist along with the single-arm study also included in the primary objective SLR (Bouffet 2023).

A8. CS Appendix D, Section D.5. Please could you undertake the quality assessments of the studies included in the ITC analysis (Lashford 2002 and Verschuur 2004)?

As requested by the EAG, please find below a quality assessment of studies included in the ITC analysis.

The Downs and Black checklist includes a cumulative score, which ranged from 13 in Verschuur 2023 to 25 in TADPOLE. The differences between the scores were driven by incomplete reporting of methodology and outcomes in older the single-arm trials for temozolomide.

Table 1: Quality assessment of Lashford 2002 and Verschuur 2004

	Checklist item	Lashford 2002		Verschuur 2004	
		Assess	Score	Assess	Score
	Reporting	Yes = 1 / No = 0			
1	Is the objective of the study clear?	Yes	1	Yes	1
2	Are the main outcomes clearly described in the	Yes	1	No	0

	Checklist item	Lashford 2002		Verschuur 2004	
		Assess	Score	Assess	Score
	Introduction or Methods?				
3	Are characteristics of the patients included in the study clearly described?	Yes	1	Yes	1
4	Are the interventions clearly described?	Yes	1	Yes	1
5	Are the distributions of principal confounders in each group of subjects clearly described?	Yes	1	Yes	1
6	Are the main findings of the study clearly described?	Yes	1	Yes	1
7	Does the study estimate random variability in data for main outcomes?	Yes	1	No	0
8	Have all the important adverse events consequential to the intervention been reported?	Yes	1	Unable to determine	0
9	Have characteristics of patients lost to follow-up been described?	Yes	1	Yes	1
10	Have actual probability values been reported for the main outcomes except probability <0.001?	Unable to determine	0	Unable to determine	0
11	Is the source of funding clearly stated?	Yes	1	No	0
12	Were subjects who were asked to participate in the study representative of the entire population recruited?	Yes	1	Yes	1

	Checklist item	Lashford 2002		Verschuur 2004	
		Assess	Score	Assess	Score
13	Were those subjects who were prepared to participate representative of the recruited population?	Yes	1	Yes	1
14	Were staff, places, and facilities where patients were treated representative of treatment most received?	Yes	1	Yes	1
15	Was an attempt made to blind study subjects to the intervention?	No	0	No	0
16	Was an attempt made to blind those measuring the main outcomes?	No	0	No	0
17	If any of the results of the study were based on data dredging was this made clear?	Not applicable	0	Not applicable	0
18	Was the time period between intervention and outcome the same for intervention and control groups or adjusted for?	Not applicable	0	Not applicable	0
19	Were the statistical tests used to assess main outcomes appropriate?	Yes	1	Yes	1
20	Was compliance with the interventions reliable?	Yes	1	Yes	1
21	Were main outcome measures used accurate? (valid and reliable)	Yes	1	Yes	1
22	Were patients in different intervention groups recruited from the same population?	Not applicable	0	Not applicable	0

	Checklist item	Lashford 2002		Verschuur 2004	
		Assess	Score	Assess	Score
23	Were study subjects in different intervention groups recruited over the same period of time	Not applicable	0	Not applicable	0
24	Were study subjects randomized to intervention groups?	No	0	No	0
25	Was the randomized intervention assignment concealed from patients and staff until recruitment was complete?	Not applicable	0	Not applicable	0
26	Was there adequate adjustment for confounding in the analyses from which main findings were drawn?	No	0	No	0
27	Were losses of patients to follow-up taken into account?	Yes	1	Yes	1
28	Was the study sufficiently powered to detect clinically important effects where probability value for a difference due to chance is <5%?	Unable to determine	0	Unable to determine	0

A9. CS Appendix D, page 22, Table 8 shows that median age in Warren 2012 study is 14.4 but the age range is 1.6–2.3. Please clarify if this is a typo.

Please accept our apologies for the confusion. Novartis confirms that the age range should be 1.6–21.3.

Clinical evidence - The TADPOLE trial

A10. CS, Section B.2.6.2.1.2.4, page 55. In the TADPOLE trial for low-grade glioma (LGG), 1 death was reported in the carboplatin with vincristine (C+V) arm and 0

deaths were reported in the dabrafenib with trametinib (D+T) arm. Please clarify for each death, if the cause of death was treatment related or other reason.

One death, due to underlying disease, was reported in the C+V arm. As per NICE's request to unmark clinical data, version 2.0 of Document B no longer includes confidential marking in Section B.2.6.2.1.2.4 (submitted 17th October 2023).

A11. CS Section B.2.3.1.3, page 35-36. Please could you confirm if treatment was stopped for all patients (C+V and D+T) before the post treatment follow-up phase?

The post-treatment period commenced 31 days after the last dose of study medication. All patients who discontinued study treatment for reasons other than disease progression, death, lost to follow up, or withdrawal of consent moved into the post-treatment follow-up phase.

A12. Please provide further information on time to treatment discontinuation. In the SmPC it states "*Duration of treatment - Treatment with Finlee should continue until disease progression or until the development of unacceptable toxicity. There are limited data in patients older than 18 years of age with glioma, therefore continued treatment into adulthood should be based on benefits and risks to the individual patient as assessed by the physician.*" Please clarify for how long patients are expected to be on D+V treatment or will they be treated indefinitely?

In Section B.3.2.8.1 of Document B, it was highlighted that clinical experts indicated that paediatric patients with LGG would not be treated with D+T indefinitely and stopping D+T after approximately 2 years in the absence of progression would be in line with current treatment protocols for chemotherapy. This is due to the indolent nature of the condition, the reduction in hazard of progression with time and age, and the benefit-risk ratio to treat patients (cumulative toxicities for no obvious clinical benefit). Indeed, clinical experts considered that in the absence of progression, treatment with D+T would likely be stopped after 2 years, and up to a maximum of 5 years for patients with LGG, depending on patient age, preference, and clinical scenario.

In contrast, for patients with HGG, clinical experts explained that the condition is aggressive and associated with a very poor prognosis and that there is a lack of effective or alternative treatment options following progression. Clinical experts

therefore explained that for paediatric patients with relapsed/refractory HGG, they would be more reluctant to stop treatment to prevent progression, and therefore are likely to continue until progression occurs for most patients. However, clinical experts explained that they would consider stopping treatment in patients who achieve a good response and maintain response for an extended duration.

A13. CS, Section B.2.10 and Appendix F. Please provide further details on how Grade 1, 2, 3, or 4 adverse events were defined.

Adverse events were assessed and graded according to the Common Terminology Criteria for Adverse Events (CTCAE) version 4.03. Grades were used to characterise the severity of the adverse event.

Indirect treatment comparisons

A14. Priority question: Please comment on whether temozolomide (TMZ) or best supportive care (BSC) is likely to be the major comparator for the high-grade glioma (HGG) cohort within the context of this appraisal.

Both TMZ and BSC are relevant comparators for this appraisal. In Section B.3.2.8.2.2 of Document B, it was highlighted that for paediatric patients with HGG that are relapsed/refractory, options are very limited and often palliative. Clinical experts explained that paediatric patients with HGG tend to receive a combination of focal radiotherapy plus TMZ in first-line (sometimes followed by lomustine [CCNU]), and that there are no effective and accepted SoC therapies following relapse or recurrence on TMZ. Temozolomide is also the only chemotherapy with a UK marketing authorisation for children and young adults in the recurrent disease setting, and has been historically used in this setting, however currently, TMZ tends to be used upfront. Clinical experts indicated that in patients who do not receive TMZ up-front (although this is rare), TMZ is the most relevant comparator. In patients who receive TMZ upfront who relapse or become refractory, TMZ is not a relevant comparator. Clinical experts indicated that for those patients, BSC/palliative care is the most relevant comparator, as chemotherapies tend to be ineffective, and there is a reluctance to expose patients to unnecessary toxic chemotherapies that do not provide a clinical benefit to the patient.

A15. Priority question: CS Section B.2.9 “Indirect and mixed treatment comparisons” does not present or discuss the ITC of D+T vs. BSC. Please define BSC and provide an ITC analysis vs BSC.

Best supportive care (BSC), as highlighted in Section B.3.2.8.3 and B.3.5.2.4 of Document B, is defined as pain and symptom management and psychosocial support in the Company submission, and was compared against D+T in the economic analysis in patients with prior TMZ exposure. No studies were identified in the SLR as providing relevant comparator data to match this definition.

In Section B.3.2.8.2.2 of Document B, it was highlighted by clinical experts that following TMZ failure, chemotherapy tends to be ineffective, and therefore using chemotherapy studies in patients previously treated with TMZ is a reasonable proxy in the economic model to inform the prognosis of patients on BSC (although likely to be optimistic) in the absence of alternative evidence. Clinical experts further explained that the aim of BSC treatment focusses on treating the symptoms and no longer the tumour, and therefore progression-free survival (PFS) is not considered a relevant outcome for the comparison against BSC.

As highlighted in Section B.3.3.4.2 in Document B, clinical experts independently explained that the prognosis for patients who received TMZ upfront and are relapsed/refractory is very poor with patients expected to survive between 3–6 months. Two studies in patients previously treated with TMZ were identified from the SLR, reported in Appendix D and used as potential proxies for BSC (MacDonald et al, 2013 [cilengitide] (3) and Narayana et al, 2010 [bevacizumab] (4)) to support the prognosis of patients on BSC (Section B.3.3.4.2 of Document B; Figure 28). It should be noted that while MacDonald et al, 2013 was included in the SLR and reported in Appendix D, Narayana et al, 2010 was identified but subsequently excluded from the SLR due to small sample size (n=12). However, despite being excluded from the SLR, evidence from Narayana et al, 2010 was presented alongside evidence from MacDonald et al, 2013 to support the assumption for the prognosis of patients on BSC (Section B.3.3.4.2 of Document B; Figure 28). As highlighted in Section B.3.3.4.2 in Document B, the clinical experts confirmed that it was reasonable to utilise outcomes from these studies as a proxy for BSC, as chemotherapy is not considered efficacious in this setting, also noting that survival in

these studies are likely to overestimate survival on BSC, and therefore is conservative for D+T.

As requested by the EAG, an ITC is provided below that compares D+T vs the two proxy studies for BSC identified in the SLR in patients previously treated with TMZ (MacDonald et al, 2013 [cilengitide] (3) and Narayana et al, 2010 [bevacizumab] (4)). While PFS is not a relevant outcome for the economic model (as the aim of treatment is to treat symptom and not the tumour), an ITC for PFS against these two studies is also reported for transparency and completeness.

Scenario analyses are included in the economic model that uses outputs (for overall survival [OS]) from the ITC presented below for the comparison against BSC.

Results are presented below in Table 2 (and incorporate changes in clarification questions B10 and C6).

Table 2: Results for the scenario analysis using results from the ITC for BSC (PAS price; disease severity modifier included)

Technologies	Total costs (£)	Total LYG [†]	Total QALYs	Incr. costs (£)	Incr. LYG [†]	Incr. QALYs	ICER (£/QALY)
Scenario analysis using HR for OS estimated from the ITC for MacDonald et al (2013)* - investigator review							
SoC (BSC)	£14,675	0.44	0.47 [§]	–	–	–	–
D+T	████████	2.78	████████ [§]	████████	2.33	████████ [§]	<u>£28,280</u>
Scenario analysis using HR for OS estimated from the ITC for MacDonald et al (2013)* - independent review							
SoC (BSC)	£18,665	0.73	0.70 [§]	–	–	–	–
D+T	████████	4.57	████████ [§]	████████	3.83	████████ [§]	<u>£31,400</u>

Note: all results presented are discounted unless otherwise stated.

[†]undiscounted; [§]disease severity modifier of 1.7; * corrected for errors identified in B10 and C6

Abbreviations: BSC, best supportive care; C, carboplatin; D, dabrafenib; ICER, incremental cost-effectiveness ratio.

Details for the ITC are presented below. Table 3 summarises the three studies (TADPOLE and the two BSC proxy studies) included in the BSC ITC. As IPD were available for TADPOLE and aggregate data available for comparator studies, unanchored MAIC methodology was utilised for the BSC comparisons.

Table 3: Summary of studies included in the BSC ITC analyses

Study name	Sample size	Treatment	Treatment type	Study design	Endpoints	Data available
TADPOLE (5)	41	Dabrafenib + trametinib	BRAF V600 inhibitor and MEK inhibitor	Phase 2, single-arm, open-label multicentre study	OS, PFS, ORR	IPD
MacDonald et al (2013) (3)	30 (24 evaluable patients)	Cilengitide	Prototypic integrin inhibitor	Phase 2, COG ACNS0621	OS, EFS, ORR	Aggregate
Narayana et al (2010) (4)	12 (10 with supratentorial HGG and 2 with DIPG)	Bevacizumab	Monoclonal antibody, targeted therapy called an angiogenesis inhibitor	Retrospective analysis of 12 consecutive paediatric patients who were diagnosed with recurrent HGG between September, 2005 and July, 2008 at New York University Langone Medical Center	OS, PFS, radiological response	Aggregate

Abbreviations: BRAF, v-raf murine sarcoma viral oncogene homolog B; BSC, best supportive care; COG, Children's Oncology Group; DIPG, diffuse intrinsic pontine glioma; EFA, event free survival; HGG, high-grade glioma; IPD, individual patient data; ITC, indirect treatment comparison; MEK, mitogen-activated protein kinase; PFS, progression-free survival; ORR, overall response rate; OS, overall survival; TMZ, temozolomide.

Inclusion/exclusion criteria

A summary of the inclusion/exclusion criteria of the studies is provided in Table 4. Narayana et al, 2010 reported very few inclusion/exclusion criteria, however, patients in Narayana et al, 2010 had recurrent supratentorial HGG or recurrent DIPG.

MacDonald et al, 2013 specified tumour localisation within the inclusion/exclusion criteria, whereas TADPOLE did not. TADPOLE included a locally confirmed histologic diagnosis, whereas MacDonald et al, 2013 had a pathologist diagnosis. Patients recruited in both TADPOLE and MacDonald et al, 2013 were progressive and relapsed/refractory to standard therapy. TADPOLE specified a smaller upper age limit of 18 years compared with 22 years in MacDonald et al, 2013, and MacDonald et al, 2013 had no lower age limit, whereas TADPOLE specified a lower age limit. Both TADPOLE and MacDonald et al, 2013 specified that patients had to have adequate organ function. Regarding performance status (PS) score, TADPOLE specified a Lansky play scale of $\geq 50\%$ and MacDonald et al, 2013 specified a PS of 0–2. Additionally, both TADPOLE and MacDonald et al, 2013 required measurable disease. Finally, patients with pontine gliomas, gliomatosis cerebri, primary spinal cord high-grade glioma, or evidence of prior central nervous system (CNS) bleed were not eligible in MacDonald et al, 2013. Therefore, the same patients from TADPOLE were excluded during population trimming for comparisons with MacDonald et al, 2013.

Table 4: Inclusion/exclusion criteria of included studies in the BSC ITC analyses

Study name	Treatment	Tumour localisation enrolled	HGG diagnosis	Recurrent or relapsed or progressed	Age	Organ function	Performance status score	Other
TADPOLE (5)	D+T	Not specified in inclusion/exclusion criteria	Locally confirmed histologic diagnosis of <i>BRAF</i> V600 mutation-positive HGG (Grade III or IV)	Relapsed, progressed, or failed to respond to frontline therapy	≥12 months to <18 years	Adequate bone marrow function, renal function, liver function, cardiac function	Karnofsky/Lansky PS ≥50%	Locally determined and centrally confirmed measurable disease Excluded if malignancy other than <i>BRAF</i> V600-mutant HGG
MacDonald et al, 2013 (3)	Cilengitide	GBM, AA, anaplastic oligodendroglioma, high-grade astrocytoma NOS or gliosarcoma	Pathologist diagnostic	Progressive and refractory to standard therapy	< 22 years	Adequate organ function	PS of 0-2	Radiographically documented measurable disease Patients with pontine gliomas, gliomatosis cerebri, primary spinal cord high-grade glioma, or evidence of prior CNS bleed were not eligible
Narayana et al, 2010 (4)	Bevacizumab	Supratentorial HGG, DIPG	NR	Recurrent	NR	NR	NR	NR

Abbreviations: AA, anaplastic astrocytoma; BSC, best supportive care; *BRAF*, v-raf murine sarcoma viral oncogene homolog B; CNS, central nervous system; D, dabrafenib; DIPG, diffuse intrinsic pontine glioma; GBM, glioblastoma multiforme; HGG, high-grade glioma; ITC, indirect treatment comparison; NOS, not otherwise specified; NR, not reported; PS, performance score; T, trametinib.

Table 5 summarises the prior therapy in the studies included in the BSC ITC analyses. TADPOLE patients received ≥ 1 prior treatment. Patients in MacDonald et al, 2013 did not receive > 2 prior treatments (1 initial and 1 for relapse). The number of prior treatments was not reported by Narayana et al, 2010. Therefore, patients with > 2 prior treatments were excluded from TADPOLE during population trimming for comparisons with MacDonald et al, 2013.

Table 5: Prior therapy for included studies in BSC ITC analyses

Study name	Treatment	Number of prior treatments	Prior treatments
TADPOLE (5)	D+T	≥ 1	If receiving glucocorticoids, stable or weaning dose for ≥ 7 days prior to first dose of study treatment Excluded if had previous treatment with RAF inhibitor, MEK inhibitor, or ERK inhibitor
MacDonald et al, 2013 (3)	Cilengitide	$\leq 2^\dagger$	Recovered from all prior therapy Prior local irradiation and alkylator-based chemotherapy or chemotherapy alone if < 3 years of age Patients < 3 years of age initially treated with chemotherapy alone could have been treated with radiation at time of first relapse
Narayana et al, 2010 (4)	Bevacizumab	NR	All patients underwent maximal surgical resection of the tumour when feasible at the time of initial diagnosis followed by radiation therapy and chemotherapy. TMZ was the initial chemotherapy of choice and was received by 11 patients both during and following radiotherapy

\dagger Patients could not have received > 2 prior treatments (1 initial and 1 for relapse)

Abbreviations: BSC, best supportive care; CNS, central nervous system; D, dabrafenib; ERK, extracellular signal-regulated kinase; ITC, indirect treatment comparison; MEK, mitogen-activated protein kinase kinase; NR, not reported; RAF, rapidly accelerated fibrosarcoma; T, trametinib; TMZ, temozolomide.

Table 6 summarises the baseline characteristics of the studies included in the BSC ITC analyses. Median age across studies ranged from 13–14.75 years. Studies enrolled between 43.9% to 58.3% of male patients. Race was only reported by TADPOLE.

Tumour grade was varied across the studies. TADPOLE enrolled approximately ██████████ Grade III patients and ██████████ Grade IV patients. TADPOLE also enrolled one patient with a Grade II classification. TADPOLE reported a high proportion of patients with missing centrally assessed tumour grade at 26.8% (11/41 patients). Comparatively,

MacDonald et al, 2013 enrolled approximately three times the proportion of Grade IV patients (62.5%), 12.5% of Grade III patients, and 12.5% patients with tumour grade not otherwise specified. Narayana et al, 2010 enrolled more Grade III patients at 75% and similar to TADPOLE, 25% of Grade IV patients.

TADPOLE and Narayana et al, 2010 reported Karnofsky or Lansky play scale, while MacDonald et al, 2013 did not report any PS. Narayana et al, 2010 reported 50% of patients with a Karnofsky or Lansky play scale score of 70–80, and 50% of patients with a score of 90–100. TADPOLE enrolled slightly more patients with a Karnofsky or Lansky play scale score of 90–100 (68.3%), and fewer patients with a score of 70–80 (19.5%). TADPOLE also enrolled 12.2% of patients with a Karnofsky or Lansky play scale score <70.

TADPOLE and Narayana et al, 2010 enrolled a majority/all patients who experienced prior surgery, at 97.6% and 100%, respectively. MacDonald et al, 2013 did not report the prior surgery status of enrolled patients. All of the patients enrolled in Narayana et al, 2010 had prior radiotherapy, whereas around 90% in MacDonald et al, 2013 and TADPOLE had prior radiotherapy. Prior chemotherapy varied across the studies, with TADPOLE and MacDonald et al, 2013 enrolling around 80% of patients with prior chemotherapy, and Narayana et al, 2010 enrolling 100% of patients with prior chemotherapy. All the patients who received prior chemotherapy in MacDonald et al, 2013 had received prior TMZ, and 91.7% of patients who received prior chemotherapy in Narayana et al, 2010 had received prior TMZ.

Table 6: Baseline characteristics of studies included in the BSC ITC analyses

Study name	TADPOLE (IPD available)	MacDonald et al (2013)	Narayana et al (2010)
Treatment	D+T	Cilengitide	Bevacizumab
Population	HGG	Evaluable patients	HGG + DIPG
N	41	24	12
Age; median (Range)	13 (2, 17)	14.2 (1.13, 20.3)	14.75 (4, 22)
Sex; n (%)			
Male	18 (43.9)	12 (50.0)	7 (58.3)
Female	23 (56.1)	12 (50.0)	5 (41.7)
Race/Ethnicity; n (%)			
White	25 (61.0)	NR	NR
Asian	11 (26.8)	NR	NR
Black or African American	1 (2.4)	NR	NR

Study name	TADPOLE (IPD available)	MacDonald et al (2013)	Narayana et al (2010)
Other	4 (9.8)	NR	NR
WHO tumour grade (central histology); n (%)			
Grade II	██████	–	–
Grade III	██████	3 (12.5) [†]	9 (75.0)
Grade IV	██████	18 (62.5) [†]	3 (25.0)
Other	Missing: ██████	NOS: 3 (12.5) [†]	–
KPS or Lansky index score; n (%)			
<70	5 (12.2)	NR	–
70-80	8 (19.5)	NR	6 (50.0)
90–100	28 (68.3)	NR	6 (50.0)
PS; n (%)			
0	28 (68.3) [†]	NR	6 (50.0) [†]
1	8 (19.5) [†]	NR	6 (50.0) [†]
2	5 (12.2) [†]	NR	–
3	–	NR	–
Prior surgery; n (%)	40 (97.6)	NR	12 (100.0) [¶]
Prior radiation therapy; n (%)	37 (90.2)	22 (91.7)	12 (100.0)
Prior chemotherapy; n (%)	33 (80.5)	20 (83.3) [‡]	12 (100.0) [§]
Metastasis; n (%)	NR	NR	NR
Prior corticosteroids; n (%)	NR	NR	NR

†Histology by review. ‡All 20 patients received prior TMZ. ¶Gross total resection. §11 patients received prior TMZ. †Converted from KPS or Lansky index score (6).

Abbreviations: BSC, best supportive care; D, dabrafenib; DIPG, diffuse intrinsic pontine glioma; HGG, high-grade glioma; IPD, individual patient data; ITC, indirect treatment comparison; KPS, Karnofsky performance score; NOS, not otherwise specified; NR, not reported; PS, performance score; T, trametinib; TMZ, temozolomide; WHO, World Health Organization.

Table 7 summarises the availability of the time-to-event outcomes in the included studies. All comparator studies reported Kaplan-Meier (KM) for OS and PFS. Median OS and PFS were longer in TADPOLE compared with MacDonald et al, 2013 and Narayana et al, 2010.

Table 7: Time-to-event outcome availability of studies included in the BSC ITC analyses

Study name	Treatment	OS KM	OS Median (95%CI)	PFS KM	PFS median (95% CI)	Notes
TADPOLE (5)	D+T	Y	Months: 32.8 (19.2, NE)	Y	Months: 9.0 (5.3, 24.0)	IPD available

Study name	Treatment	OS KM	OS Median (95%CI)	PFS KM	PFS median (95% CI)	Notes
MacDonald et al, 2013 (3)	Cilengitide	Y	Days: 28 (11, 114)	Y	Days:172 (28, 325)	Defined as EFS
Narayana et al, 2010 (4)	Bevacizumab	Y	Months: 6.25 (1.9, 22)	Y	Months: 2.25 (1, 16)	–

Abbreviations: BSC, best supportive care; CI, confidence interval; D, dabrafenib; EFS, event free survival; IPD, individual patient data; ITC, indirect treatment comparison; KM, Kaplan-Meier; NE, not estimable; OS, overall survival; PFS, progression-free survival; T, trametinib.

Table 8 summarises the time-to-event outcome definitions used in the included studies. OS was defined as the time from the first dose of treatment to death due to any cause in TADPOLE and Narayana et al, 2010. MacDonald et al, 2010 did not define OS, however specified an event included death owing to any cause.

PFS was defined as the time from the first dose of treatment to progression or death due to any cause, as assessed separately by central independent reviewer per RANO criteria in TADPOLE. MacDonald measured event-free survival (EFS), with an event including tumour progression or recurrence, second malignant neoplasm, or death. This was considered comparable enough to the definition in TADPOLE, and therefore a treatment comparison was made using this study. However, Narayana et al, 2010 defined PFS as the time of the initial bevacizumab treatment to the date of first radiological/clinical progression. This definition was not considered sufficiently similar to that in TADPOLE, and no PFS comparison was made.

Table 8: Time-to-event outcome definitions of studies included in the BSC ITC analyses

Study name	Treatment	OS definition	PFS definition
TADPOLE	D+T	Time from first dose of study treatment to death due to any cause	Time from first dose of study treatment to progression or death due to any cause, as assessed separately by central independent reviewer per RANO criteria
MacDonald et al, 2013	Cilengitide	OS event included death owing to any cause	EFS: event included tumour progression or recurrence, second malignant neoplasm, or death
Narayana et al, 2010	Bevacizumab	OS was measured from the time of bevacizumab therapy to the time of death	Progression was defined as a 25% or greater increase in the size of a pre-existing enhancing lesion, appearance of a new lesion, or neurological deterioration that cannot be attributed to another cause. PFS was measured from the time of the initial bevacizumab treatment to the date of first radiological/clinical progression

Abbreviations: BSC, best supportive care; D, dabrafenib; EFS, event free survival; ITC, indirect treatment comparison; N/A, not applicable; OS, overall survival; PFS, progression-free survival; RANO, response assessment in neuro-oncology; T, trametinib; TMZ, temozolomide.

Table 9 summarises the availability of response outcomes in the included studies. All three studies reported overall response rate (ORR). TADPOLE and Narayana et al, 2010 defined ORR as complete response (CR) or partial response (PR), where MacDonald et al, 2013 defined ORR as CR, PR or stable disease (SD). TADPOLE used the RANO response criteria, Narayana et al, 2010 used the MacDonald criteria for a radiological response, and MacDonald et al, 2013 did not specify a response criteria. The definition in MacDonald et al, 2013 was not deemed comparable with TADPOLE due to the addition of SD in the definition of ORR. Therefore, ORR analyses were conducted comparing with Narayana et al, 2010 only.

Table 9: Response outcome availability of studies included in the BSC ITC analyses

Study name	Treatment	ORR (95% CI)	ORR definition	Notes
TADPOLE	D+T	56.1% (39.7, 71.5)	Defined as the proportion of patients with BOR of confirmed CR or PR by independent review as per RANO criteria	IPD available

Study name	Treatment	ORR (95% CI)	ORR definition	Notes
MacDonald et al, 2013	Cilengitide	1 response was observed during stage 1	Confirmed CR, PR or SD that was sustained for at least 12 weeks	ORR definition does not match with TADPOLE
Narayana et al, 2010	Bevacizumab	16.7%	CR + improvement (partial radiological response) Radiological response: MacDonald criteria, which use maximal cross-sectional T1 contrast images on MRI as well as Fluid Attenuated Inversion Recovery sequences, were used to define the radiological response	

Abbreviations: BSC, best supportive care; BOR, best overall response; CR, complete response; D, dabrafenib; IPD, individual patient data; ITC, indirect treatment comparison; MRI, magnetic reasoning imagine; ORR, overall response rate; PR, partial response; RANO, response assessment in neuro-oncology; SD, stable disease; T, trametinib.

Table 10: BSC analyses conducted

Comparator study	Endpoint	Method	Matching variables	Trimming	Notes
MacDonald et al, 2013	OS	MAIC	<ul style="list-style-type: none"> • Age • Prior radiotherapy • Prior TMZ 	<ul style="list-style-type: none"> • Excluded 4 patients from TADPOLE with DMG 	<ul style="list-style-type: none"> • TADPOLE all patients base case sample size: 37 • Limitation that MacDonald et al (2013) enrolled older patients, max age of 20.3 compared with 17 in TADPOLE
	PFS	MAIC			
Narayana et al, 2010	OS	MAIC	<ul style="list-style-type: none"> • Age • Prior TMZ 	<ul style="list-style-type: none"> • Excluded 1 patient with missing prior surgery data from TADPOLE • Exclude 8 further patients without prior chemotherapy • Excluded 4 further patients who have not had prior radiotherapy 	<ul style="list-style-type: none"> • TADPOLE all patients base case sample size: 28 • Limitation that Narayana et al (2010) enrolled older patients, max age of 22 compared to 17 in TADPOLE • Narayana et al (2010) had a small sample size of 12 patients • TADPOLE enrolled 5 patients with Karnofsky or <70, not enrolled in Narayana et al (2010)
	ORR	MAIC			

Abbreviations: DMG, diffuse midline glioma; MAIC, matching-adjusted indirect comparison; ORR, overall response rate; OS, overall survival; PFS, progression free survival; PS, performance score; TMZ, temozolomide.

MacDonald et al, 2013 MAIC comparison

Table 11 presents the TADPOLE HGG all patients cohort (unadjusted and weighted) and MacDonald et al, 2013 study baseline characteristics. Matching was based on percentage of patients aged <14.2 years (median age amongst patients in MacDonald et al, 2013), prior radiotherapy (%) and prior TMZ (%). The ESS was around one-third smaller than the original sample size.

Table 11: Comparison of baseline characteristics: MAIC D+T (TADPOLE) vs cilengitide (MacDonald et al, 2013)

Treatment (study)	N/ESS	Age < 14.2 (%)	Prior radiotherapy (%)	Prior TMZ (%)
D+T unadjusted (TADPOLE)	■	■	■	■
D+T weighted (TADPOLE)	■	■	■	■
Cilengitide (MacDonald et al, 2013)	24	50.0	91.7	83.3

Abbreviations: D, dabrafenib; ESS, effective sample size; MAIC, matching-adjusted indirect comparison; N, sample size; T, trametinib; TMZ, temozolomide.

MacDonald et al, 2013 OS results

The KM plots for OS for patients receiving D+T for the unadjusted and weighted patient data, compared with patients receiving cilengitide are shown in Figure 1. Median OS was almost five times longer for D+T patients pre- or post-weighting compared with cilengitide patients (Table 12), with patients treated with D+T experiencing significantly longer OS in both pre- and post-weighting analyses.

Figure 1: Kaplan-Meier plot for OS MAIC: D+T matched with cilengitide patient characteristics (MacDonald et al, 2013)

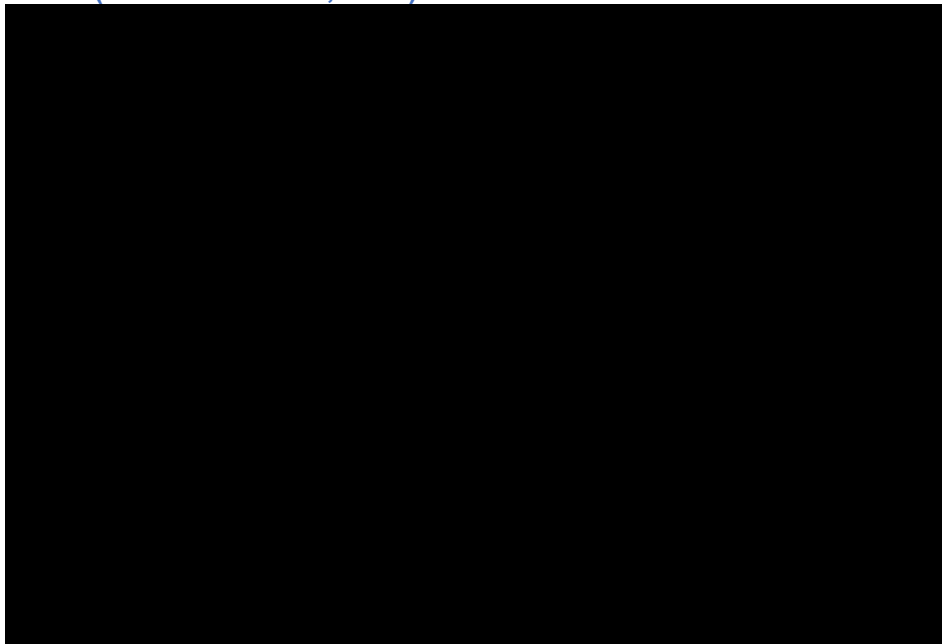

Abbreviations: D, dabrafenib; MAIC, matching-adjusted indirect comparison; OS, overall survival; T, trametinib.

Table 12: Summary of OS MAIC: D+T (TADPOLE) vs cilengitide (MacDonald et al, 2013)

Treatment (study)	N/ESS	Events	Median OS, months (95% CI)	D+T vs Cilengitide HR (95% CI)
D+T naïve comparison	■	■	██████████	██████████
D+T weighted	■	■	██████████	██████████
Cilengitide	24	23	6.05 (3.99, NE)	Comparator

Bold indicates a significant difference between treatments.

Abbreviations: CI, confidence interval; D, dabrafenib; ESS, effective sample size; HR, hazard ratio; MAIC, matching-adjusted indirect comparison; NE, not evaluable; OS, overall survival; T, trametinib.

MacDonald et al, 2013 PFS results

The KM plots for PFS for patients receiving D+T for the unadjusted and weighted patient data, compared with patients receiving cilengitide are shown in Figure 2. Median PFS was almost nine times longer for D+T patients pre- or post-weighting estimates compared with cilengitide patients (Table 13), with patients treated with D+T experiencing significantly longer PFS in both pre- and post-weighting analyses.

Figure 2: Kaplan-Meier plot for PFS MAIC: D+T matched with cilengitide patient characteristics (MacDonald et al, 2013)

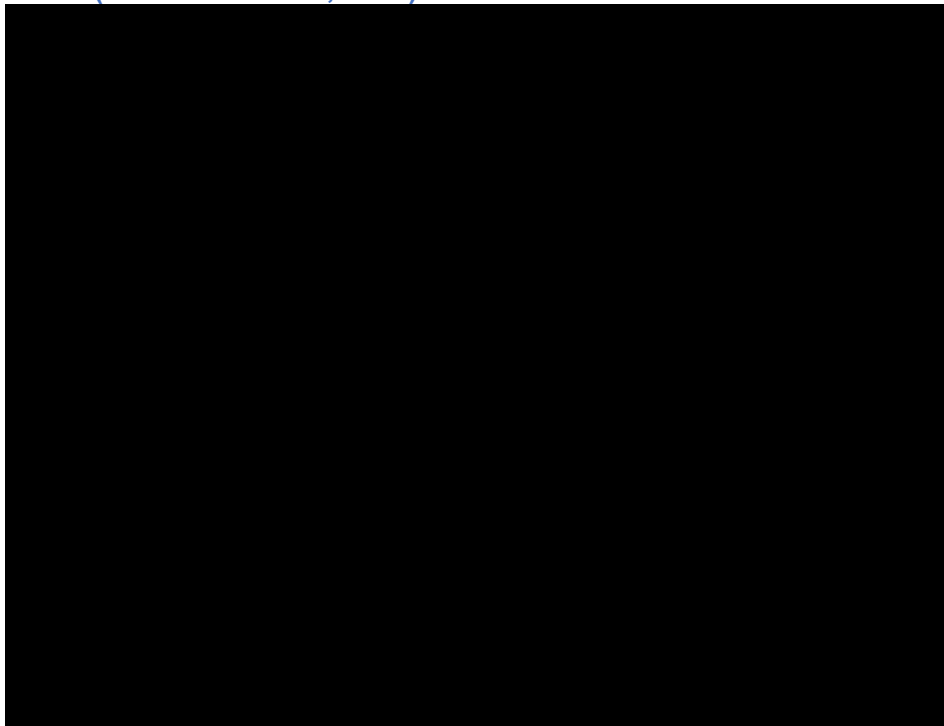

Abbreviations: D, dabrafenib; MAIC, matching-adjusted indirect comparison; PFS, progression free survival; T, trametinib.

Table 13: Summary of PFS MAIC: D+T (TADPOLE) vs cilengitide (MacDonald et al, 2013)

Treatment (study)	N/ESS	Events	Median PFS, months (95% CI)	D+T vs Cilengitide HR (95% CI)
D+T naïve comparison	■	■	██████████	██████████
D+T weighted	■	██	██████████	██████████
Cilengitide	24	23	1.00 (0.94, 1.10)	Comparator

Bold text indicates a significant difference between treatments.

Abbreviations: CI, confidence interval; D, dabrafenib; ESS, effective sample size; HR, hazard ratio; MAIC, matching-adjusted indirect comparison; NE, not evaluable; PFS, progression free survival; T, trametinib.

Narayana et al, 2010 MAIC comparison

Table 14 presents the TADPOLE HGG patient cohort (unadjusted and weighted) and Narayana et al, 2010 study baseline characteristics. Matching was based on percentage of patients aged <14.75 years (median age in Narayana et al, 2010), and prior TMZ (%). The ESS was similar to the original sample size (ESS=24.2).

Table 14: Comparison of baseline characteristics: MAIC D+T (TADPOLE) vs bevacizumab (Narayana et al, 2010)

Treatment (study)	N/ESS	Age < 14.75 (%)	Prior TMZ (%)
D+T unadjusted (TADPOLE)	■	■	■
D+T weighted (TADPOLE)	■	■	■
Cilengitide (Narayana et al (2010))	12	50	91.7

Abbreviations: D, dabrafenib; ESS, effective sample size; MAIC, matching-adjusted indirect comparison; N, sample size; T, trametinib; TMZ, temozolomide.

Narayana et al, 2010 OS results

The KM plots for OS for patients receiving D+T for the unadjusted and weighted patient data, compared with patients receiving bevacizumab are shown in Figure 3. Median OS was approximately five times longer for D+T patients pre- or post-weighting compared with bevacizumab patients (Table 15), with patients treated with D+T experiencing significantly longer OS in both pre- and post-weighting analyses.

Figure 3: Kaplan-Meier plot for OS MAIC: D+T matched with bevacizumab patient characteristics (Narayana et al, 2010)

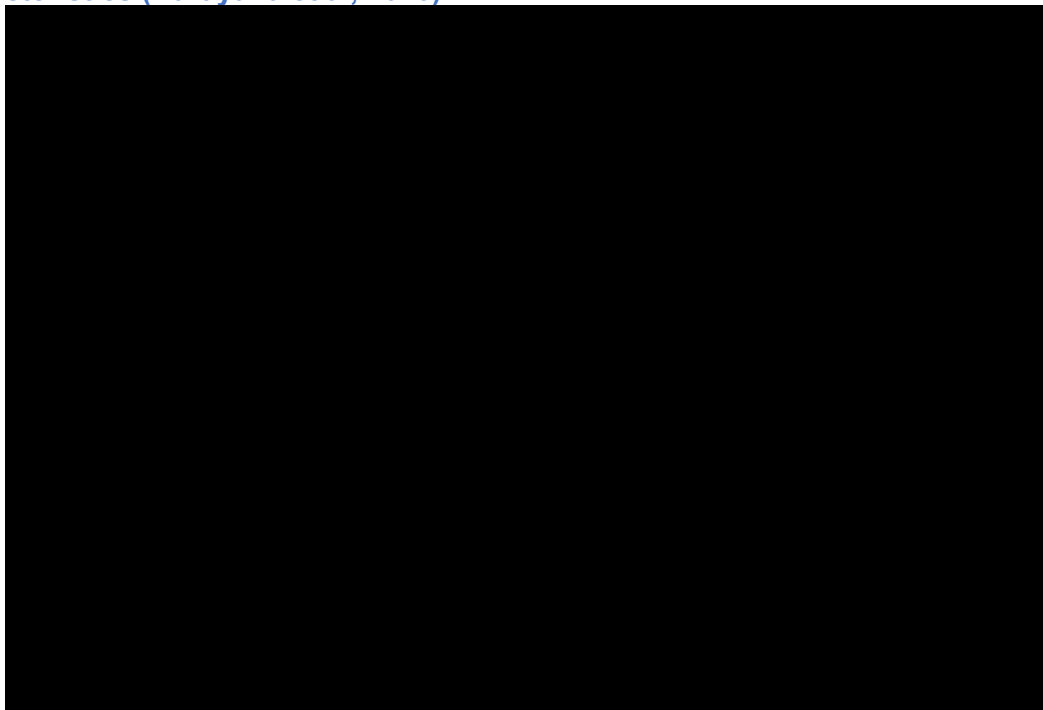

Abbreviations: D, dabrafenib; MAIC, matching-adjusted indirect comparison; OS, overall survival; T, trametinib.

Table 15: Summary of OS MAIC: D+T (TADPOLE) vs bevacizumab (Narayana et al, 2010)

Treatment (study)	N/ESS	Events	Median OS, months (95% CI)	D+T vs bevacizumab HR (95% CI)
D+T naïve comparison	■	■	■	■
D+T weighted	■	■	■	■
Bevacizumab	12	10	6.67 (4.04, 11.0)	Comparator

Bold text indicates a significant difference between treatments.

Abbreviations: CI, confidence interval; D, dabrafenib; ESS, effective sample size; HR, hazard ratio; MAIC, matching-adjusted indirect comparison; NE, not evaluable; OS, overall survival; T, trametinib.

Narayana et al, 2010 ORR results

Table 16 presents the unadjusted and weighted odds ratio (OR) for overall response outcomes, in TADPOLE and Narayana et al, 2010. The OR estimates were associated with a lot of uncertainty, although the result was significantly in favour of D+T compared with bevacizumab in the unweighted comparison.

Table 16: Odds ratio for ORR (TMZ-naïve subgroup): D+T (TADPOLE) vs bevacizumab (Narayana et al, 2010)

Outcome	Method	D+T ORR, n/N (%)	Bevacizumab ORR, n/N (%)	D+T vs Bevacizumab OR (95% CI)
ORR	Naïve comparison (unadjusted)	■	2/12 (16.7%)	■
	Weighted sandwich estimator	■		■

Bold indicates a significant difference between treatments.

Abbreviations: CI, confidence interval; D, dabrafenib; OR, odds ratio; ORR, overall response rate; T, trametinib.

A16. Priority question: Please clarify whether progression-free survival (PFS) by independent review or investigator assessment was used for the analysis of HGG patients in the ITC. If the latter, please provide a scenario analysis using PFS by independent review.

As per Table 18 in Appendix D (and replicated in Table 17), Novartis confirms that PFS was assessed by central independent review for the MAIC comparisons.

Table 17 (Table 18, Appendix D of CS): Time-to-event outcome definitions

Study name	Treatment	OS definition	PFS definition
TADPOLE (5)	D+T	Time from first dose of study treatment to death due to any cause	Time from first dose of study treatment to progression or death due to any cause, as assessed separately by central independent reviewer per RANO criteria
Lashford 2002 (7)	TMZ	OS	N/A
Verschuur 2004 (8)	TMZ	OS determined from the start of TMZ treatment for each patient	Interval between first day of first cycle of TMZ and occurrence of tumour progression

Abbreviations: CS, Company Submission; D, dabrafenib; N/A, not applicable; OS, overall survival; PFS, progression-free survival; RANO, response assessment in neuro-oncology; T, trametinib; TMZ, temozolomide.

A17. CS page 67 states that “Verschuur 2004 excluded patients with brainstem glioma. Therefore, patients from TADPOLE with brainstem glioma were excluded during population trimming for comparisons with Verschuur 2004.”:

- a) Please update the column “Additional trimming for TMZ-naive population analyses” in CS Table 23 to describe the additional trimming performed on the population aside from trimming based on prior TMZ treatment for the TADPOLE trial. For example, please include the number of patients excluded due to brainstem glioma diagnosis.
- b) In the same column please provide numbers of patients who were excluded due to previous treatment with TMZ.
- c) In the column “Notes”, please provide the sample size of the resulting TADPOLE study (post trimming) used within the ITC.

As requested by the EAG, please find below the updated Table 23 of Document B.

Table 18 (Table 23, Document B of CS): ITC analyses conducted

Comparator study	Endpoint	Method	Matching variables	Trimming for all patients analyses	Trimming for TMZ-naïve population analyses	Notes
Main analyses (TADPOLE TMZ-naïve patients)						
Verschuur 2004 (8)	OS	MAIC	<ul style="list-style-type: none"> Age Prior radiotherapy Prior chemotherapy Tumour grade (sensitivity analysis only) 	<ul style="list-style-type: none"> Excluded █ patients from TADPOLE with DMG Excluded █ further patient with missing prior surgery data from TADPOLE Excluded █ further patient with missing prior chemotherapy data from TADPOLE Excluded █ further patients from TADPOLE with missing centrally assessed tumour grade data (tumour grade analysis only, base case includes these patients) 	<ul style="list-style-type: none"> Excluded █ patients with prior TMZ from TADPOLE Excluded █ further patients from TADPOLE with DMG Patient with missing prior surgery data already excluded Excluded █ further patient with missing prior chemotherapy data from TADPOLE Excluded █ further patients from TADPOLE with missing centrally assessed tumour grade data (tumour grade analysis only, base case includes these patients) 	<ul style="list-style-type: none"> TADPOLE all patients base case sample size: █ TADPOLE all patients tumour grade analysis sample size: █ TADPOLE TMZ naïve patients base case sample size: █ TADPOLE TMZ naïve patients tumour grade analysis sample size: █ Limitation was that Verschuur 2004 could enrol slightly older patients; 4 patients enrolled were older than 18 years old, the limit in TADPOLE In Verschuur 2004, 1 patient was Grade II and had longer PFS (34+ months compared with the next highest at 14 months), therefore this patient is likely to have longer OS compared with the other patients enrolled Verschuur 2004 had a small sample size of 20 patients (15 treated after radiotherapy and 5 treated prior to radiotherapy)
	PFS	IPTW		<ul style="list-style-type: none"> Excluded 4 patients from Verschuur 2004 who are older than 18 years olds Excluded 5 further patients from Verschuur 2004 who had no prior surgery Excluded █ patients from TADPOLE with DMG 	<ul style="list-style-type: none"> Excluded 4 patients from Verschuur 2004 who are older than 18 years olds Excluded 5 further patients from Verschuur 2004 who had no prior surgery Excluded █ patients with prior TMZ from TADPOLE Excluded █ further patients from TADPOLE with DMG 	<ul style="list-style-type: none"> TADPOLE all patients base case sample size: █ TADPOLE all patients tumour grade analysis sample size: █ TADPOLE TMZ naïve patients base case sample size: █ TADPOLE TMZ naïve patients tumour grade analysis sample size: █
	ORR					

Comparator study	Endpoint	Method	Matching variables	Trimming for all patients analyses	Trimming for TMZ-naïve population analyses	Notes
				<ul style="list-style-type: none"> Excluded █ further patient with missing prior surgery data from TADPOLE Excluded █ further patient with missing prior chemotherapy data from TADPOLE Excluded █ further patients from TADPOLE with missing centrally assessed tumour grade data (tumour grade analysis only, base case includes these patients) 	<ul style="list-style-type: none"> Patient with missing prior surgery data already excluded Excluded █ further patient with missing prior chemotherapy data from TADPOLE Excluded █ patients from TADPOLE with missing centrally assessed tumour grade data (tumour grade analysis only, base case includes these patients) 	<ul style="list-style-type: none"> Limitation that excluding patients from Verschuur 2004 dataset leads to a small comparator set of just 11 patients (8 treated after radiotherapy and 3 treated prior to radiotherapy)
Lashford 2002 (7)	ORR	MAIC	<ul style="list-style-type: none"> Age Prior chemotherapy 	<ul style="list-style-type: none"> Excluded █ patients from TADPOLE with DMG Excluded █ further patients who have not had prior radiotherapy (2 patients are also <3 years old) Excluded █ further patient with missing prior chemotherapy data from TADPOLE 	<ul style="list-style-type: none"> Excluded █ patients with prior TMZ from TADPOLE Excluded █ further patients from TADPOLE with DMG Excluded █ further patients who have not had prior radiotherapy (2 patients are also <3 years old) Excluded █ further patient with missing prior chemotherapy data from TADPOLE 	<ul style="list-style-type: none"> TADPOLE all patients base case sample size: █ TADPOLE TMZ naïve patients base case sample size: █ Lashford 2002 had a small sample size of 25 patients

Abbreviations: DMG, diffuse midline glioma; IPTW, inverse probability of treatment weighting; MAIC, matching-adjusted indirect comparison; ORR, overall response rate; OS, overall survival; PFS, progression free survival; PS, performance score; TMZ, temozolomide.

A18. CS page 67 states that Verschuur 2004 enrolled one patient with a WHO grade II glioma and that this patient was excluded from the ITC analyses. Please clarify the rationale behind this exclusion and comment on the impact of the ITC results if this patient is included within the analysis.

In TADPOLE, all patients except one (97.6%) had prior surgery. Therefore, to compare similar populations, patients without prior surgery were excluded from TADPOLE and Verschuur 2004 for the IPTW PFS and ORR analyses. The Grade II patient did not have prior surgery, and was therefore also excluded from the analysis.

A19. The study used as the main source for the comparator arm for the HGG cohort, Verschuur 2004, is nearly 20 years old. Please comment on the potential impact of using such an old study for the comparator arm to inform the ITC.

The Company acknowledges that standard of care may have varied between the Verschuur et al, 2004 and TADPOLE studies, however, the MAIC and the economic model uses PFS, with the same post-progression survival assumed in the economic model. OS is more likely to be subject to bias due to change in practice or better management of patient. In contrast, PFS is less subject to bias and influenced by salvage treatment given post-progression. Furthermore, the SLR (Appendix D, Table 8) identified seven studies that evaluated TMZ, of which three reported consistent data on; Warren et al, 2012 (median PFS: 1.7 month); Ruggiero et al, 2006 (median PFS: 3 months) and Verschuur et al, 2004 (median PFS: 2 months).

A20. CS Appendix D.5.5 lists potential prognostic factors for patients with HGG by a UK clinical expert. Please clarify whether any treatment effect modifiers were also identified.

Novartis confirms that the UK clinical experts identified potential prognostic factors for patients with HGG only. In addition, it was not possible to identify treatment effect modifiers from TADPOLE or published literature included due to the single-arm design of the trials in paediatric HGG.

A21. CS Table 25. Please explain why the width of the confidence interval (CI) for the hazard ratio (HR) for the D+T weighted analysis is narrower when a bootstrap approach is used compared to the standard approach.

The HR estimate is unstable due to the small ESS. The bootstrap reduces uncertainty for this dataset, however, it is considered the more robust estimate for the variance compared with the standard variance estimate, since the weights are estimates and not known quantities, as described in the NICE DSU TSD 18 (9).

A21. CS Table 27. Please explain why the width of the CI is identical when using robust SE, compared to the CI for the naive comparison.

Table 27 is replicated below with the HRs (and 95% CIs) displayed to three decimal places (Table 19). Therefore, to a higher degree of accuracy, the CIs are not identical. However, they are very similar, as the weighting had little impact on the comparison. This is observed in the unchanged median PFS estimates presented. The very small sample size in both treatment arms may also have impacted the findings of the analysis.

Table 19: Summary of PFS IPTW (TMZ-naïve subgroup): D+T (TADPOLE) vs TMZ (Verschuur 2004)

Treatment (study)	N	Events	Median PFS, months (95% CI)	D+T vs TMZ HR (95% CI)
D+T naïve comparison	█	█	█	█
TMZ unweighted	11	11	2.0 (1.5, NE)	Comparator
D+T weighted	█	█	█	█
TMZ weighted	11.0	11.0	2.0 (1.5, NE)	Comparator

Bold indicates a significant difference between treatments.

Abbreviations: CI, confidence interval; D, dabrafenib; HR, hazard ratio; IPTW, inverse probability of treatment weighting; NE, not evaluable; PFS, progression-free survival; SE, standard error; T, trametinib; TMZ, temozolomide.

A22. A previous study showed that overall survival (OS) varied significantly by race/ethnicity among childhood gliomas (Jiang, W., et al. (2020). "Racial/Ethnic Disparities and Survival in Pediatrics with Gliomas Based on the Surveillance, Epidemiology, and End Results Database in the United States." World Neurosurgery 141: e524-e529). CS Table 8 in document B shows that there were racial differences

between D+T and V+C treatment groups. Please clarify if the effect of race/ethnicity was considered in OS outcome.

In the TADPOLE trial, for LGG, one death was reported in the comparator arm, and no deaths were reported in the D+T arm. Therefore, no HR could be estimated.

For the MAIC analysis for the HGG cohort, as highlighted in Table 22 in document B, Verschuur et al, 2004 and Lashford et al, 2002 did not report race/ethnicity.

Therefore, it was not possible to adjust for this baseline characteristics in the ITC analyses.

Section B: Clarification on cost-effectiveness data

Implementation of sampling time to event in the VBA code of the submitted model

B1. Priority question: Please clarify, for all functions in the Generate_TTE module, what sources have you used to determine the mathematical formulae applied and what validation of these VBA functions were conducted.

The survival parameters were estimated in R using the “flexsurvreg” R package. As requested by the EAG, a validation sheet (see sheet “validation”) is now included in the economic model (using PFS as assessed by the independent reviewer for the LGG cohort as an example) that compares for all distributions (7 standards, hazard, odd and normal spline models up to 4 knots) the (1) direct fit in R, (2) the direct fit in Excel, and (3) the curves predicted from the simulation (when sampling).

Figure 4 presents the validation for the exponential and log-normal distributions for PFS using independent review for the LGG cohort (key distributions used in the economic analysis); results for other distribution are available in the Microsoft® Excel economic model.

Figure 4: Validation for the exponential and lognormal distribution

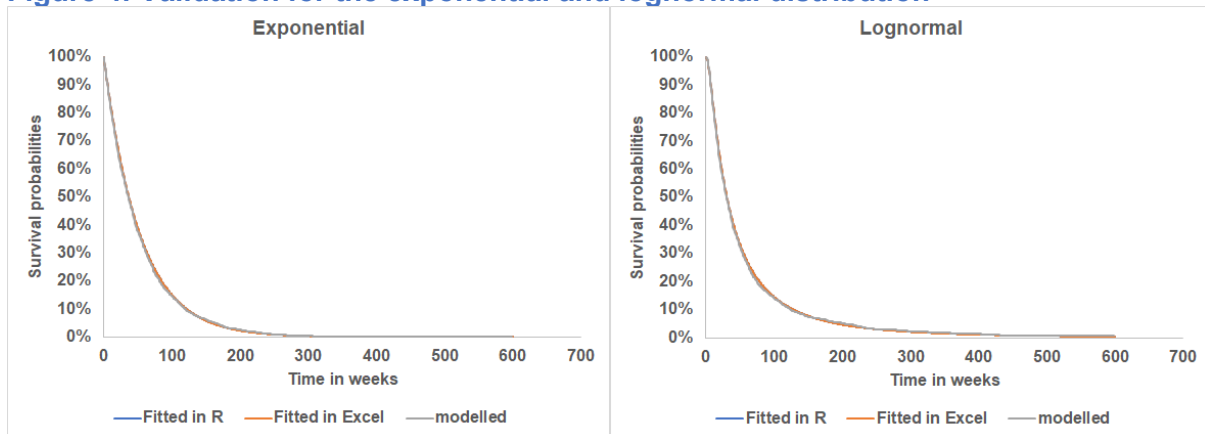

As the sampled curves predicted from the simulation are identical to those fitted in R (see “validation” sheet), this confirms the correct implementation within the economic model in Excel for all parametric distributions.

Survival analyses used in the cost-effectiveness model

B2. Priority question: Please provide scenario analysis for extrapolating the outcomes (a-c) listed below, using the standard parametric distributions (exponential, Weibull, Gompertz, gamma, log-normal, log-logistic and generalised gamma). In the case where the standard parametric models do not fit the data and/or do not provide plausible long-term extrapolation, please also explore the use of more flexible models (spline odds model, spline normal model, spline hazard model) with one, two and three knots. Please also provide the Akaike Information Criterion (AIC) and Bayesian Information Criterion (BIC) accordingly.

- a) LGG cohort: PFS by independent review
- b) HGG cohort: Using IPTW adjusted data from the HGG cohort for the D+T arm for PFS by independent review
- c) HGG cohort: Using IPTW adjusted data from the HGG cohort for the TMZ arm for PFS

As requested by the EAG, the model now includes the functionality to explore the use of gamma distribution and more flexible models (hazard, normal and odds spline models with up to four knots) for all time-to-event endpoints.

Novartis further confirms that the option for using PFS by independent review assessment for the LGG cohort is already included in the model, with results reported in Appendix Q. Updated results for this scenario following correction of errors identified by the EAG in B10 and C6 are reported in Table 20.

Table 20: Results for the scenario analysis using PFS as assessed by the independent review for the LGG cohort (PAS price; disease severity modifier included)

Technologies	Total costs (£)	Total LYG [†]	Total QALYs	Incr. costs (£)	Incr. LYG [†]	Incr. QALYs	ICER (£/QALY)
Scenario using PFS assessed per independent review*							
SoC (C+V)	£88,566	27.20	8.09 [‡]	–	–	–	–
D+T	████████	43.04	████████ [‡]	████████	15.84	████████ [‡]	£14,483

Note: all results presented are discounted unless otherwise stated.

[†]undiscounted; [‡]disease severity modifier of 1.2; * error in B10 and C6 corrected

Abbreviations: C, carboplatin; D, dabrafenib; ICER, incremental cost-effectiveness ratio; incr., incremental; LYG, life-year gained; PAS: patient access scheme; QALY, quality-adjusted life year; T, trametinib; V, vincristine.

Novartis wishes to highlight that a small error in the estimation of the KM and survival parameters for PFS (using investigator review only) for the LGG cohort was identified and rectified during review of the model at clarification question stage, leading to a small change in the ICER (Table 21) for the LGG cohort (£25,918 vs £25,572), prior to correction of errors highlighted by the EAG in B10 and C6 (Table 21).

Table 21: Results for the LGG cohort following correction of errors identified by the company and EAG (PAS price; disease severity modifier included)

Technologies	Total costs (£)	Total LYG [†]	Total QALYs	Incr. costs (£)	Incr. LYG [†]	Incr. QALYs	ICER (£/QALY)
Company base case in CS							
SoC (C+V)	£88,450	47.52	13.67 [‡]	–	–	–	–
D+T	████████	57.79	████████ [‡]	████████	10.27	████████ [‡]	£25,918
Company base case after correction of the error identified at CQ by the company							
SoC (C+V)	£88,454	47.52	13.67 [‡]	–	–	–	–
D+T	████████	57.85	████████ [‡]	████████	10.33	████████ [‡]	£25,572

Technologies	Total costs (£)	Total LYG [†]	Total QALYs	Incr. costs (£)	Incr. LYG [†]	Incr. QALYs	ICER (£/QALY)
Company base case after correction of the error identified at CQ by the company and those highlighted by the EAG in Q B10 and C6*							
SoC (C+V)	£88,416	47.52	13.67 [‡]	–	–	–	–
D+T	████████	57.85	████████ [‡]	████████	10.33	████████ [‡]	£25,776

Note: all results presented are discounted unless otherwise stated.

[†]undiscounted; [‡]disease severity modifier of 1.2

Abbreviations: C, carboplatin; D, dabrafenib; ICER, incremental cost-effectiveness ratio; incr., incremental; LYG, life-year gained; PAS: patient access scheme; QALY, quality-adjusted life year; T, trametinib; V, vincristine.

Finally, as requested by the EAG, an option has been added in the economic model to use the IPTW adjusted data for D+T and TMZ for the HGG comparison in patients not previously treated with TMZ. The option can be found in the “OPTIONS” sheet, under the label “HGG TMZ analysis - PFS use HR or IPTW” in Row 62.

Results for this scenario requested by the EAG (using IPTW adjusted data – independent review only) after correction of errors identified by the EAG in B10 and C6 are presented in Table 22.

Table 22: Results for the scenario using the IPTW adjusted data for D+T and TMZ for the HGG cohort not previously treated with TMZ (PAS price; disease severity modifier included)

Technologies	Total costs (£)	Total LYG [†]	Total QALYs	Incr. costs (£)	Incr. LYG [†]	Incr. QALYs	ICER (£/QALY)
Company base case (using PFS as per investigator review)*							
Scenario using IPTW adjusted data*							
SoC (TMZ)	£50,308	2.97	1.57 [§]	–	–	–	–
D+T	████████ ^x	4.00	████████ [§]	████████	1.03	████████ [§]	£29,992

Note: all results presented are discounted unless otherwise stated.

[†]undiscounted; [§]disease severity modifier of 1.7; * error in B10 and C6 corrected

Abbreviations: D, dabrafenib; ICER, incremental cost-effectiveness ratio; incr., incremental; LYG, life-year gained; PAS: patient access scheme; QALY, quality-adjusted life year; T, trametinib; TMZ, temozolomide.

B3. Priority question: Please provide plots showing the empirical/unsmoothed and smooth hazard functions for the time-to-event endpoints used in survival extrapolation in the submission, including the scenario analysis requested in question B2.

As requested by the EAG, plots showing the empirical/unsmoothed and smooth hazard function for the time to event endpoints are provided in the updated Appendix P, submitted as part of this response to clarification questions.

The empirical (unsmoothed) hazard functions were estimated using the “muhaz” package in R while the smoothed hazard function was estimated using the “bshazard” package in R.

Unfortunately, these functions do not allow the application of weights, which is necessary for plotting the hazard for the IPTW data. Therefore, for IPTW data, the unweighted hazard plots are presented. While imperfect, the weighted and unweighted KM were very similar and therefore can be helpful in interpreting the hazard functions.

B4. Priority question: For time-to-event endpoints used in the economic model within the submission, please also provide extrapolation using a gamma distribution. In cases where the standard parametric models do not fit the data and/or do not provide plausible long-term extrapolations, please also provide the extrapolation using more flexible models including the spline odds model (one/two/three knots), spline normal model (one/two/three knots) and spline hazard model (two/three knots). Please also provide AIC and BIC accordingly.

As requested by the EAG, the model now includes the functionality to explore the use of the gamma distribution and more flexible models (hazard, normal and odds spline models with up to four knots) for all time-to-event endpoints. The AIC/BICs are provided in the updated Appendix P, alongside the visual fit of the distributions.

B5. Priority question: In cases where parametric extrapolation is used following the Kaplan-Meier (KM) curve, please provide additional scenario analyses exploring the use of the entire fitted distribution in the economic model, including those requested in B2 and B4. Please also provide an updated economic model reflecting the additional scenario analyses.

Novartis confirms that the option for using parametric extrapolation for the entire period is already included in the model.

Key results including for the additional scenarios requested by the EAG are provided in Table 23. Please note, results are presented following correction of the errors identified by the EAG in B10 and C6, and the error identified by the Company reported in B2.

- **Scenario 1:** LGG – using PFS as per investigator review (CS)
- **Scenario 2:** LGG – using PFS as per independent review (EAG requested scenario B2)
- **Scenario 3:** HGG – no prior TMZ – using PFS as per investigator review (CS)
- **Scenario 4:** HGG – no prior TMZ – using PFS as per independent review (company scenario)
- **Scenario 5:** HGG – no prior TMZ – using IPTW adjusted data – independent review (EAG requested scenario B2)
- **Scenario 6:** HGG –prior TMZ – using PFS as per investigator review (CS)
- **Scenario 7:** HGG – prior TMZ – using PFS as per independent review (company scenario)
- **Scenario 8:** HGG –prior TMZ – using PFS as per investigator review and HR from the MAIC vs BSC in response to Q A15
- **Scenario 9 :** HGG –prior TMZ – using PFS as per independent review and HR from the MAIC vs BSC in response to Q A15.

Table 23: Results for the scenario using parametric extrapolation for the entire period (PAS price; disease severity modifier included)

Technologies	Total costs (£)	Total LYG [†]	Total QALYs	Incr. costs (£)	Incr. LYG [†]	Incr. QALYs	ICER (£/QALY)
Scenario 1: LGG – using PFS as per investigator review (CS) *							
SoC (C+V)	£88,846	45.79	13.42 [‡]	–	–	–	–
D+T	████████	55.50	████████ [‡]	████████	9.72	████████ [‡]	<u>£19,912</u>
Scenario 2: LGG – using PFS as per independent review (EAG requested scenario B2) *							
SoC (C+V)	£89,464	27.15	8.02 [‡]	–	–	–	–
D+T	████████	36.03	████████ [‡]	████████	8.89	████████ [‡]	<u>£15,471</u>
Scenario 3: HGG – no prior TMZ – using PFS as per investigator review (CS) *							
SoC (TMZ)	£27,773	1.38	1.37 [§]	–	–	–	–
D+T	████████	5.80	████████ [§]	████████	4.42	████████ [§]	<u>£29,529</u>
Scenario 4: HGG – no prior TMZ – using PFS as per independent review (company scenario) *							
SoC (TMZ)	£50,265	2.96	1.57 [§]	–	–	–	–
D+T	████████	4.30	████████ [§]	████████	1.34	████████ [§]	<u>£29,698</u>

Technologies	Total costs (£)	Total LYG [†]	Total QALYs	Incr. costs (£)	Incr. LYG [†]	Incr. QALYs	ICER (£/QALY)
Scenario 5: HGG – no prior TMZ – using IPTW adjusted data – independent review (EAG requested scenario B2) *							
SoC (TMZ)	£49,770	2.83	1.40 [§]	–	–	–	–
D+T	██████	4.27	██████ [§]	██████	1.44	██████ [§]	<u>£27,279</u>
Scenario 6: HGG –prior TMZ – using PFS as per investigator review (CS) *							
SoC (BSC)	£20,873	0.90	0.76 [§]	–	–	–	–
D+T	██████	3.02	██████ [§]	██████	2.12	██████ [§]	<u>£29,320</u>
Scenario 7: HGG – prior TMZ – using PFS as per independent review (company scenario) *							
SoC (TMZ)	£44,865	2.80	1.36 [§]	–	–	–	–
D+T	██████	4.89	██████ [§]	██████	2.09	██████ [§]	<u>£29,059</u>
Scenario 8: HGG –prior TMZ – using PFS as per investigator review and HR from the MAIC vs BSC in response to A15*							
SoC (TMZ)	£15,225	0.48	0.51 [§]	–	–	–	–
D+T	██████	3.02	██████ [§]	██████	2.53	██████ [§]	<u>£28,687</u>
Scenario 9 : HGG –prior TMZ – using PFS as per independent review and HR from the MAIC vs BSC in response to A15*							
SoC (BSC)	£19,378	0.78	0.74 [§]	–	–	–	–
D+T	██████	4.89	██████ [§]	██████	4.10	██████ [§]	<u>£31,407</u>

Note: all results presented are discounted unless otherwise stated.

[†]undiscounted; [‡]disease severity modifier of 1.2; [§]disease severity modifier of 1.7; * after correction of errors in B2, B10 and C6

Abbreviations: BSC: best supportive care; C, carboplatin; D, dabrafenib; ICER, incremental cost-effectiveness ratio; incr., incremental; LYG, life-year gained; PAS: patient access scheme; QALY, quality-adjusted life year; T, trametinib; V, vincristine. TMZ: temozolomide

B6. In CS Appendix P, please clarify the data source used to inform each extrapolation.

As requested by the EAG, Appendix P was updated to include the data source for all figures.

B7. Please clarify why the KM curve displayed in CS Figure 23 for the D+T TMZ-naive group is different from the KM curve displayed in CS Figure 17 for the D+T unweighted arm.

Please accept our apologies for the confusion. The data included in the ITC (Figure 17) used to calculate the relative treatment effect of D+T vs TMZ uses PFS per independent review based on RANO criteria from TADPOLE, while the economic model uses PFS per investigator assessment. The ITC uses PFS per independent review to provide a conservative estimate of the relative treatment effect, as it is unclear from Verschuur et al, 2004 which PFS definition was used. In contrast, the

economic model uses PFS assessed by the investigator review to reflect clinical practice as highlighted in Section B.3.3.2.

B8. CS page 104, it is stated that for the extrapolation of PFS that “*The fit of each parametric function relative to the KM curve is presented in Appendix P. With the exception of the exponential, and the generalised gamma distributions (that did not converge)*”. In Appendix P, the AIC and BIC statistics are however reported for the exponential distribution fit. Please clarify whether the exponential distribution suffered from non-convergence.

Please accept our apologies for the confusion. The sentence should have read as “*The fit of each parametric function relative to the KM curve is presented in Appendix P. With the exception of the exponential (which did not have a good fit to the data), and the generalised gamma distributions (that did not converge)...*”

B9. Please clarify why no uncertainty in the KM curves was included in the probabilistic sensitivity analysis (PSA) and comment on the effect of including uncertainty in the KM curves within the PSA.

The uncertainty around the KM was not included to prevent slowing down the economic model and increase the file size of the economic model. However, as requested by the EAG, the uncertainty around the KM is now included using bootstrapping approach.

The PSA (for the Company base case) was re-run, with probabilistic results presented in Table 24.

Table 24: Updated PSA results – CS assumptions (PAS price; disease severity modifier included)

Technologies	Total costs (£)	Total QALYs	Incr. costs (£)	Incr. QALYs	ICER (£/QALY)	Probability of cost-effectiveness [†]
LGG cohort*						
SoC (C+V)	£86,825	13.13 [‡]	-	-	-	-
D+T	████████	████████ [‡]	████████	████████ [‡]	£26,606	70.70%
HGG cohort - No prior TMZ*						
SoC (TMZ)	£28,011	1.4 [§]	-	-	-	-
D+T	████████	████████ [§]	████████	████████ [§]	£28,226	69.30%

Technologies	Total costs (£)	Total QALYs	Incr. costs (£)	Incr. QALYs	ICER (£/QALY)	Probability of cost-effectiveness [†]
HGG cohort - Prior TMZ*						
SoC (BSC)	£21,386	0.77 [§]	-	-	-	-
D+T	██████	██████ [§]	██████	██████ [§]	£28,734	72.20%

Note: all results presented are discounted unless otherwise stated.

[†]The probability of D+T being cost-effective vs clinical management in the UK at a WTP threshold of £30,000/QALY; [‡]disease severity modifier of 1.2; [§]disease severity modifier of 1.7; * errors in B2, B10 and C6 corrected

Abbreviations: BSC, best supportive care; C: carboplatin; D, dabrafenib; HGG, high-grade glioma; ICER, incremental cost-effectiveness ratio; incr., incremental; LGG, low-grade glioma; PAS: patient access scheme; QALY, quality-adjusted life year; SoC, standard of care; T, trametinib; TMZ, temozolomide; UK, United Kingdom; V, vincristine; WTP, willingness-to-pay.

In summary, including the uncertainty in the KM did not result in a material change in the PSA results compared with those presented in Section B.3.10 in Document B (Table 24 and Figure 5).

Figure 5: PSA cost-effectiveness plane and CEAC (PAS price; disease severity applied)

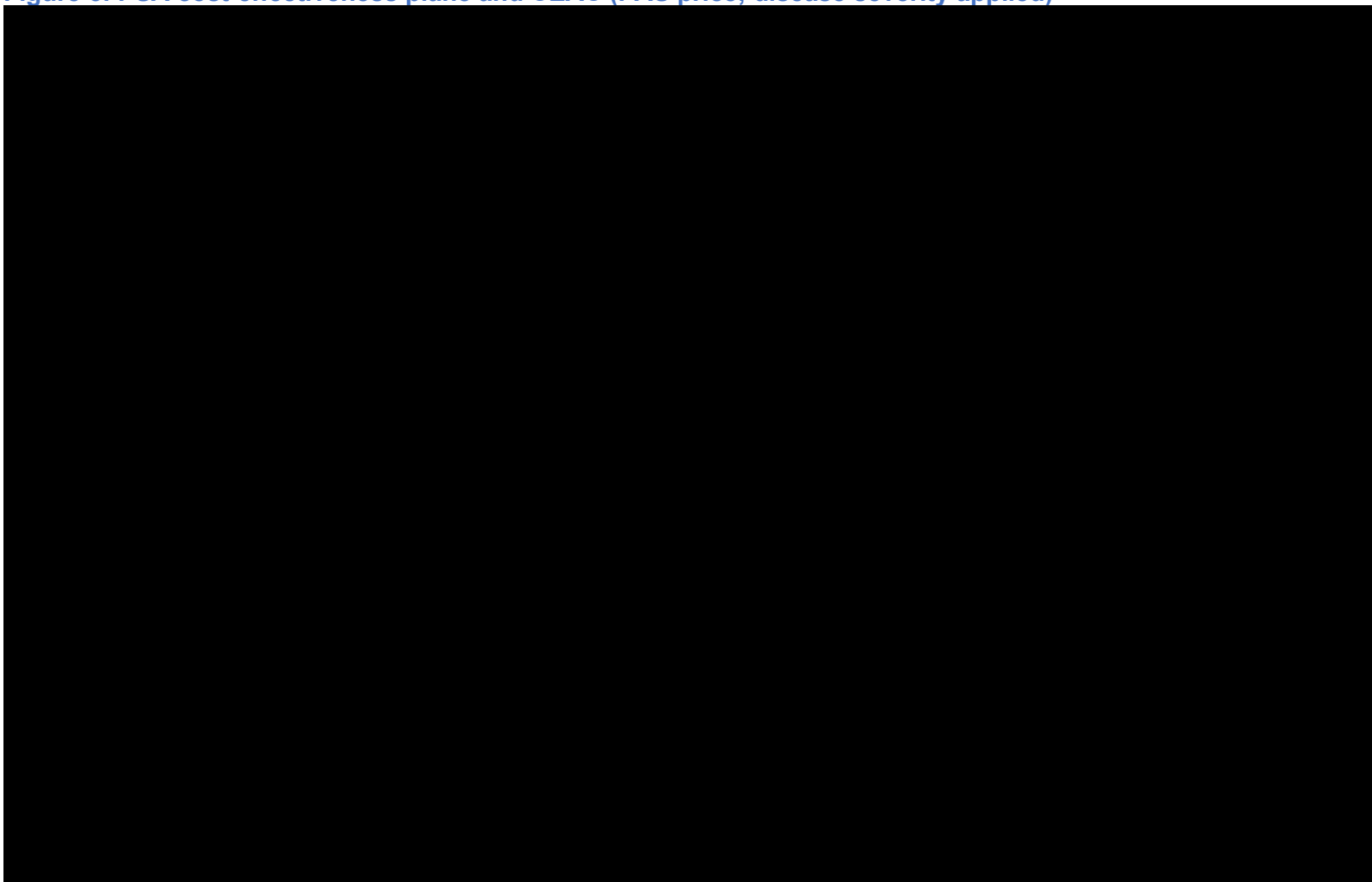

Note: all results presented are discounted unless otherwise stated. Disease severity modifier of 1.2 for LGG; disease severity modifier of 1.7 for HGG.
Abbreviations: BSC, best supportive care; CE, cost-effectiveness; CEAC, cost-effectiveness acceptability curve; D, dabrafenib; HGG, high-grade glioma; ICER, incremental cost-effectiveness ratio; LGG, low-grade glioma; PSA, probabilistic sensitivity analysis; QALY, quality-adjusted life year; T, trametinib; TMZ, temozolomide; WTP, willingness-to-pay threshold.

Cost queries

B10. Please clarify, the weighted average of currency codes PK72A – PK72C (paediatric metabolic disorders) using the total HRGs is £3,275.35 when calculated from the NHS reference costs FY21-22 v3. The value used for this in the model is £740.15. Which value should be used in your analysis?

Thank you for highlighting this error. The analysis should use the cost of £3,275.35 for paediatric metabolic disorders. The model has been revised to apply the correct cost, with results presented in this document correcting for this error (Table 2, Table 20, Table 21, Table 22, Table 23, and Table 24).

B11. Please clarify, the costs in CS for proton beam therapy quoted a price of £39,450. In the reference provided this reflects 100% utilisation, but the report had a different cost of £53,687 to reflect NHS usage (73%). Why was the cost reflecting 100% utilisation used in your analysis?

The cost of proton beam therapy is uncertain. A cost of £39,450 was used to provide a conservative estimate of the cost of proton beam therapy.

B12. Please clarify, why were the phlebotomy costs excluded from blood test and coagulation test costs?

Venepuncture was assumed to occur during the clinical examination in which blood tests were performed. A unit cost of £316.49 was applied to clinical examinations, and it was considered sufficient to include the time required to take blood samples. A separate cost for phlebotomy was not applied to avoid double counting the cost.

B13. Please clarify what was assumed in the submitted model about drug wastage? If it has been included, please clarify how this is factored into the economic analyses. If it has not been included in your estimates, please clarify why this hasn't been included and what data there is on drug wastage (if any) in the LGG and HGG populations from TADPOLE.

Drug wastage was not included in the economic model, as data were not available for the LGG and HGG populations from TADPOLE to inform these assumptions.

Utility parameters

B14. Please clarify, which paper and what methods (if any) were used to calculate the age-gender population norms for the UK in your submission. The quoted paper “Hernandez Alava M, Pudney S, Wailoo A. Estimating the Relationship Between EQ-5D-5L and EQ-5D-3L: Results from a UK Population Study. *Pharmacoeconomics*. 2023;41(2):199-207” does not contain the values contained in Sheet HRQoL, Cells J35:K161 of the economic model or an equation that can produce these values. The figures instead appear to match the following reference. “M Hernández Alava, S Pudney, A Wailoo (2022) [Estimating EQ-5D by Age and Sex for the UK \(PDF, 428KB\)](#). NICE DSU report”.

Please accept our apologies for the confusion. The EAG is correct and the reference should read as “M Hernández Alava, S Pudney, A Wailoo (2022) [Estimating EQ-5D by Age and Sex for the UK \(PDF, 428KB\)](#). NICE DSU report”.

B15. Please clarify if “M Hernández Alava, S Pudney, A Wailoo (2022) [Estimating EQ-5D by Age and Sex for the UK \(PDF, 428KB\)](#). NICE DSU report” was used, why have you implemented the age gender utilities as fixed values, when regression coefficients and a covariance matrix are provided on the NICE DSU webpage for this report (<https://www.sheffield.ac.uk/nice-dsu/methods-development/estimating-eq-5d>). This means it is possible to put these parameters into the PSA conducted in your model using a multivariate normal distribution.

In the absence of a clear example on how to implement the regression model, fixed values reported by the authors were used. Attempts have been made to replicate the published age and gender-based utilities using the published regression coefficients and covariance matrices. While we were able to replicate the published values for men relatively well, predictions for females were less accurate. However, the PSA led to an implausible sample, indicating errors in our implementation. While it was not used to generate results, our attempt at implementing the DSU regression model is included in the economic model in the sheet named “Utility_age_Regression”.

It should be noted that the overall impact of including this uncertainty is likely to be small, and to have negligible impact on the mean incremental QALYs estimated from

the probabilistic analysis as the DSU regression model was estimated in a large sample size (n=7,085).

B16. Table 45 in the CS (CS, page 123-124) states that the 95% CIs were not applicable for the almost all of the utility parameters in your model. Please clarify, why was uncertainty not considered in the utility values used?

Please accept our apologies for the confusion. The footnote of the table should have read as 'not available' rather than 'not applicable'. Data on the utility loss associated with LGG and HGG at model entry was estimated from two or more separate sources (utility values with and without the condition), and therefore the CI was not available, as the values were calculated from multiple sources rather than reported in a single paper. Similarly, the weekly reduction in HRQoL and QALY loss associated with IV administration were calculated based on a set of assumptions, and therefore the CI was not available. Uncertainty in these utility estimates was however captured in the probabilistic analysis under an assumption that the standard error for the parameters was 10% of the mean value.

B17. Please clarify why reference 101 (Janssen *et al.* 2019) was used to determine the baseline utility in the general population when calculating the utility decrement for LGG, when the general population utility in your model likely uses a different source for general population utilities (see Question B14).

Janssen *et al.*, 2019 was used when calculating the decrement in utility for patients with HGG to align with the country (EQ-5D tariff) from which utility values for HGG were estimated (the US). Using data from the UK to calculate the decrement would potentially lead to inconsistency due to differences in EQ-5D tariffs.

B18. Please clarify why utility decrements were used in your submission and not utility multipliers. The NICE methods guide (<https://www.nice.org.uk/process/pmg36>) states in point 4.3.7 (page 73) that a "multiplicative method is generally preferred" for adjusting utility values from general population norms.

Economic models typically use a starting utility value for a given health state, obtained from the trial or external source, with the utility value reducing with age to avoid situations where the utility value for the health state is greater than that observed in the general population.

The NICE method guide states: *“If baseline utility values are extrapolated over long time horizons, they should be adjusted to reflect decreases in health-related quality of life seen in the general population and to make sure that they do not exceed general population values at a given age. Adjustment should be based on a recent and robust source of population health-related quality of life. If this is not considered appropriate for a particular model, the supporting rationale should be provided. A multiplicative approach is generally preferred.”*

There are no EQ-5D data for paediatric patients with glioma. Therefore, we estimated the decrement for patients with versus those without the condition from adults. This decrement is then applied to the baseline quality of life (QoL) in patients without the condition, which reflect the utility values from the general population at a given age and is therefore in line with the NICE method guide.

Patients with LGG can also experience multiple disease progressions over the course of their disease. Using decrements (relative to model entry) ensures the application of a consistent absolute disutility at each disease progression, rather than assuming different impact between the first and subsequent progression. It should be noted that this approach (baseline QoL and decrement for events) is commonly used in economic models that consider several events, including as cardiovascular disease (CVD) or diabetes.

B19. Please clarify where any Health Related Quality of Life instruments collected from children and/or their parents/guardians in TADPOLE study that might be useful to inform utility estimates? If they weren't collected, why were they not collected? If they were, why were they not used to help inform the appropriateness of the utility scores in the economic model?

The Patient Reported Outcomes Measurement Information Service (PROMIS) Parent Proxy Global Health 7+2 was used to evaluate the HRQoL of patients in the LGG cohort. However, as there is no available mapping algorithm to the EQ-5D, it was not possible to use the PROMIS Parent proxy to help inform the appropriateness of the utility scores in the economic model.

Section C: Textual clarification and additional points

C1. Please clarify, which NHS reference cost currency codes did you intend to use in Table 52. The model generally uses weighted averages of all currency codes across the end letters, the table only specifies one specific currency code (for example, the cost of a reduced Neutrophil count is quoted as being currency code PG71A and has a cost of £3062. However £3062 is the weighted average by count of the currency codes PG71A, PG71B and PG71C).

Please accept our apologies for the confusion. The currency codes in Table 52 are incomplete. Novartis confirms that the unit costs for each adverse event listed in Table 52 were calculated as a weighted average of all the currency codes across the end letters. An exception to this was the unit cost for hypertension, which was derived from the single currency code EB04Z (hypertension).

Table 25 presents the correct description of the currency code.

Table 25: Updated Table 52, Document B

AEs	Unit cost	Source
Neutrophil count decreased	£3,062	NHS Reference cost 2021/2022 (10): Paediatric, Hepatobiliary or Pancreatic Disorders (PG71A-C)
White blood cell count decreased	£3,062	
Alanine aminotransferase increased	£3,062	
Lymphocyte count decreased	£3,062	
Platelet count decreased	£3,062	
Blood creatine phosphokinase increased	£3,062	
Gamma-	£3,062	
Hypomagnesaemia	£3,062	
Aspartate	£3,062	
Ejection fraction	£3,062	
Amylase increased	£3,062	
Lipase increased	£3,062	
Hypersensitivity	£1,476	
Abdominal infection	£1,476	
Device related infection	£1,476	
Infusion related reaction	£1,476	
Viral infection	£1,476	
Rash	£704	

AEs	Unit cost	Source
Urticaria	£704	NHS Reference cost 2021/2022 (10): Paediatric, Rash or Other Non-Specific Skin Eruption (PJ66A-C)
Flushing	£704	
Hypertension	£770	NHS Reference cost 2021/2022 (10): Hypertension (EB04Z)
Hypotension	£770	
Headache	£1,116	NHS Reference cost 2021/2022 (10): Paediatric, Headaches or Migraines (PR04A-C)
Dizziness	£1,116	
Gastrointestinal	£1,542	NHS Reference cost 2021/2022 (10): Paediatric Other Gastrointestinal Disorders (PF26A-C)
Diarrhoea	£1,542	
Agitation	£2,200	NHS Reference cost 2021/2022 (10): Paediatric Behavioural Disorders (PT52A-B)
Confusional state	£2,200	
Peripheral motor	£861	NHS Reference cost 2021/2022 (10): Paediatric Abdominal Pain (PX29A-C)
Peripheral sensory	£861	
Uterine haemorrhage	£861	
Anaemia	£1,519	NHS Reference cost 2021/2022 (10): Haemolytic Anaemia (SA03G)
Neutropenia	£10,303	NHS Reference cost 2021/2022 (10): Paediatric Febrile Neutropenia with Malignancy (PM45A)
Thrombocytopenia	£993	NHS Reference cost 2021/2022 (10): Thrombocytopenia (SA12G-H)
Pyrexia	£1,116	NHS Reference cost 2021/2022 (10): Paediatric, Headaches or Migraines (PR04A-C)
Weight increased	£740	NHS Reference cost 2021/2022 (10): Paediatric Metabolic Disorders (PK72A-C)
Uveitis	£1,375	NHS Reference cost 2021/2022 (10): Paediatric Non-Surgical Ophthalmology (PP64A-B)
Vomiting	£1,480	NHS Reference cost 2021/2022 (10): Paediatric, Feeding Difficulties or Vomiting (PF28A-E)
Pancreatitis	£3,062	NHS Reference cost 2021/2022 (10): Paediatric, Hepatobiliary or Pancreatic Disorders (PG71A-C)
Influenza like illness	£1,431	NHS Reference cost 2021/2022 (10): Paediatric Fever of Unknown Origin (PW20A-C)
Brain oedema	£978	NHS Reference cost 2021/2022 (10): Paediatric, Head, Neck or Ear Disorders (PC63A-D)

C2. It appears that some section references appear in the CS incorrectly, please update the section references that appear in the text as references to sections B.4 (and subsequent subsections).

Section cross-references were updated and corrected in version 2.0 of Document B, submitted to NICE on 17th October 2023.

C3. In CS Figure 3, the clinical pathway diagram, please clarify whether the Chemotherapy 1st line treatment for the LGG cohort should be, vinblastine &

carboplatin, or, vincristine & carboplatin which is referred to as the main comparator for the LGG cohort.

Thank you for highlighting this error. We confirm that the first-line chemotherapy for LGG is vincristine & carboplatin, as outlined in the Children's Cancer and Leukaemia group (CCLG) 2020 guidelines for the diagnosis and management of paediatric and adolescent Low-Grade Glioma (11).

C4. Where possible, please provide the questions asked during the three consultation calls with clinical experts which are summarised and included within the reference pack.

The slide deck, including pre-planned questions to inform the discussion with clinicians are provided as part of this response.

C5. It appears that both BRAF V600 mutations and BRAF V600E mutations are referred to throughout the CS. Please clarify the usage of BRAF V600 versus BRAF V600E mutations throughout the CS. For example, in CS B.2.9.2.1 it is stated that "TADPOLE enrolled patients with BRAF V600 mutation; neither Lashford 2002, nor Verschuur 2004 measured BRAF V600 status".

Please accept our apologies for the confusion. Novartis confirms that the TADPOLE study enrolled *BRAF* V600E mutation-positive patients only.

Other reference to *BRAF* V600 (rather than V600E) in the company submission refers to:

- **Prognosis/epidemiology.** References used to describe the prognosis and epidemiology comes from a mix of studies reporting either on data in patients with a *BRAF* V600 or *BRAF* V600E. It should be noted that Andrew et al, 2022 (12) reported that the most common oncogenic driver mutation in *BRAF* is V600E (≈90%)
- **Testing.** In England, patients diagnosed with glioma are routinely tested for common driver mutations, including *BRAF* V600 mutations and *BRAF* V600E, via next generation sequencing (NGS) panel testing.

- **Indications for trametinib and dabrafenib in adults for lung and melanoma.** The indications for lung and melanoma are wider in patients with a *BRAF* V600 mutation.
- **Inclusion criteria for the SLR (primary objective).** *BRAF* V600 was used to be more inclusive.

C6. Several of the treatments in Table 46 of the CS have outdated eMIT prices. Please update the model with the latest eMIT prices for these treatments.

Thank you for highlighting this update. The model has been revised to apply the updated eMIT prices with results presented in this document reflecting this change (Table 2, Table 20, Table 21, Table 22, Table 23 and Table 24). The impact on the cost-effectiveness are minimal.

References

1. Nobre L, Zapotocky M, Ramaswamy V, Ryall S, Bennett J, Alderete D, et al. Outcomes of BRAF V600E Pediatric Gliomas Treated With Targeted BRAF Inhibition. *JCO Precision Oncology*. 2020(4):561-71.
2. Coutant M, Lhermitte B, Guerin E, Chammas A, Reita D, Sebastia C, et al. Retrospective and integrative analyses of molecular characteristics and their specific imaging parameters in pediatric grade 1 gliomas. *Pediatr Blood Cancer*. 2022;69(8):e29575.
3. MacDonald TJ, Vezina G, Stewart CF, Turner D, Pierson CR, Chen L, et al. Phase II study of cilengitide in the treatment of refractory or relapsed high-grade gliomas in children: a report from the Children's Oncology Group. *Neuro Oncol*. 2013;15(10):1438-44.
4. Narayana A, Kunnakkat S, Chacko-Mathew J, Gardner S, Karajannis M, Raza S, et al. Bevacizumab in recurrent high-grade pediatric gliomas. *Neuro Oncol*. 2010;12(9):985-90.
5. Novartis. Clinical study report - Final analysis - April 2023. Phase II open-label global study to evaluate the effect of dabrafenib in combination with trametinib in children and adolescent patients with BRAF V600 mutation positive Low Grade Glioma (LGG) or relapsed or refractory High Grade Glioma (HGG). 2023.
6. Le Teuff G, Castaneda-Heredia A, Dufour C, Jaspan T, Calmon R, Devos A, et al. Phase II study of temozolomide and topotecan (TOTEM) in children with relapsed or refractory extracranial and central nervous system tumors including medulloblastoma with post hoc Bayesian analysis: A European ITCC study. *Pediatr Blood Cancer*. 2020;67(1):e28032.
7. Lashford LS, Thiesse P, Jouvet A, Jaspan T, Couanet D, Griffiths PD, et al. Temozolomide in malignant gliomas of childhood: a United Kingdom Children's Cancer Study Group and French Society for Pediatric Oncology Intergroup Study. *J Clin Oncol*. 2002;20(24):4684-91.
8. Verschuur AC, Grill J, Lelouch-Tubiana A, Couanet D, Kalifa C, Vassal G. Temozolomide in paediatric high-grade glioma: a key for combination therapy? *Br J Cancer*. 2004;91(3):425-9.
9. Phillippo DM, Ades AE, Dias S, Palmer S, Abrams KR, Welton NJ. NICE DSU TSD 18: Methods for Population-Adjusted Indirect Comparisons in Submissions To NICE 2016 [Available from: <https://www.sheffield.ac.uk/nice-dsu/tsds/population-adjusted>].
10. National Health Service England. National Cost Collection Data for 2021-2022. Available at: <https://www.england.nhs.uk/costing-in-the-nhs/national-cost-collection/>. 2023.
11. Picton S, Kilday J, Hargrave D, Bailey S, O'Hare P, Ajithkumar T, et al. Guidelines for the diagnosis and management of paediatric and adolescent Low-Grade Glioma. Children's Cancer and Leukaemia Group. 2020.
12. Andrews LJ, Thornton ZA, Saincher SS, Yao IY, Dawson S, McGuinness LA, et al. Prevalence of BRAFV600 in glioma and use of BRAF Inhibitors in patients with BRAFV600 mutation-positive glioma: systematic review. *Neuro Oncol*. 2022;24(4):528-40.

Appendix P: Extrapolation

P1 LGG: PFS C+V (investigator review)

Figure 1: Fit to the KM

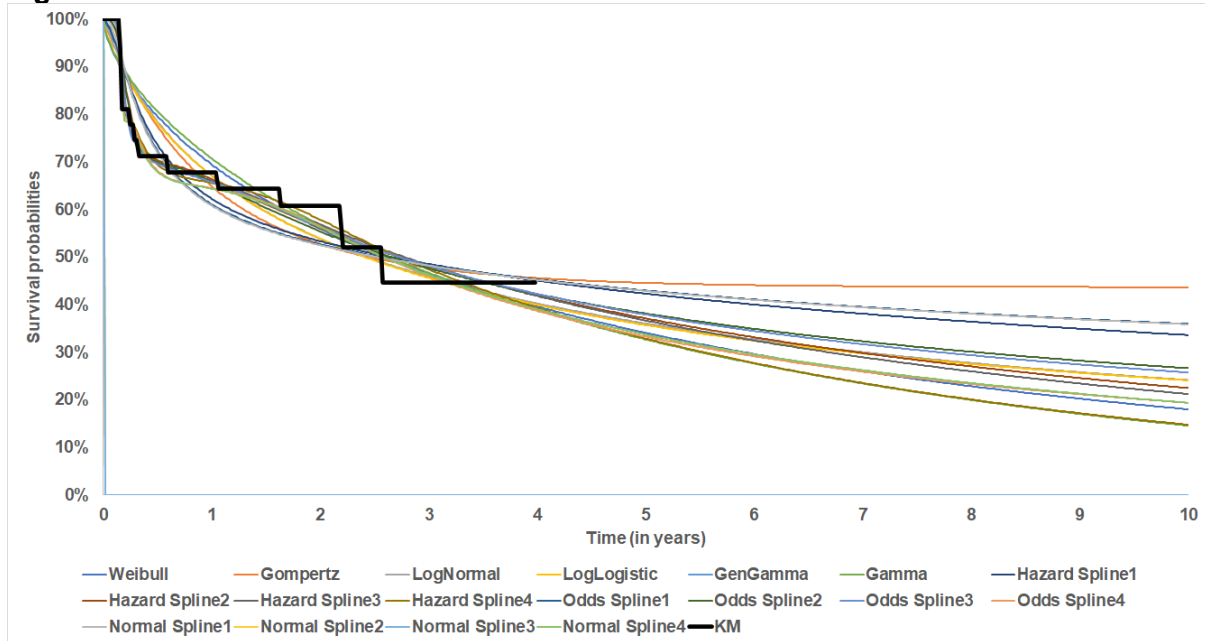

Source: Analysis of the TADPOLE trial (1).

Abbreviations: exp, exponential; gomp, Gompertz; genGamma, generalised gamma; KM, Kaplan-Meier; llog, log-logistic; lnorm, log-normal; Spline1: spline with 1 knot; Spline2: spline with 2 knots; Spline3: spline with 3 knots; Spline4: spline with 4 knots; weib, Weibull.

Table 1: Statistical fit

	AIC	BIC	Rank AIC	Rank BIC
Exponential	188.3	189.8	16.0	15.0
Weibull	186.6	189.6	14.0	14.0
Gompertz	185.0	188.0	12.0	12.0
LogNormal	183.8	186.7	11.0	9.0
LogLogistic	185.4	188.4	13.0	13.0
GenGamma	NA	NA	#VALUE!	#VALUE!
Gamma	187.2	190.2	15.0	16.0
Hazard Spline1	183.0	187.5	10.0	11.0
Hazard Spline2	174.9	180.9	7.0	7.0
Hazard Spline3	172.9	180.3	5.0	5.0
Hazard Spline4	168.4	177.4	2.0	2.0
Odds Spline1	182.6	187.1	9.0	10.0
Odds Spline2	174.5	180.4	6.0	6.0
Odds Spline3	172.6	180.1	4.0	4.0
Odds Spline4	168.8	177.8	3.0	3.0
Normal Spline1	181.2	185.7	8.0	8.0
Normal Spline2	NA	NA	#VALUE!	#VALUE!
Normal Spline3	NA	NA	#VALUE!	#VALUE!
Normal Spline4	167.1	176.1	1.0	1.0

Source: Analysis of the TADPOLE trial (1).

Abbreviations: AIC, Akaike Information Criterion; BIC, Bayesian Information Criterion; GenGamma, generalised gamma; N/A, not applicable, Spline1: spline with 1 knot; Spline2: spline with 2 knots; Spline3: spline with 3 knots; Spline4: spline with 4 knots.

Figure 2: Smoothed and unsmoothed hazard function

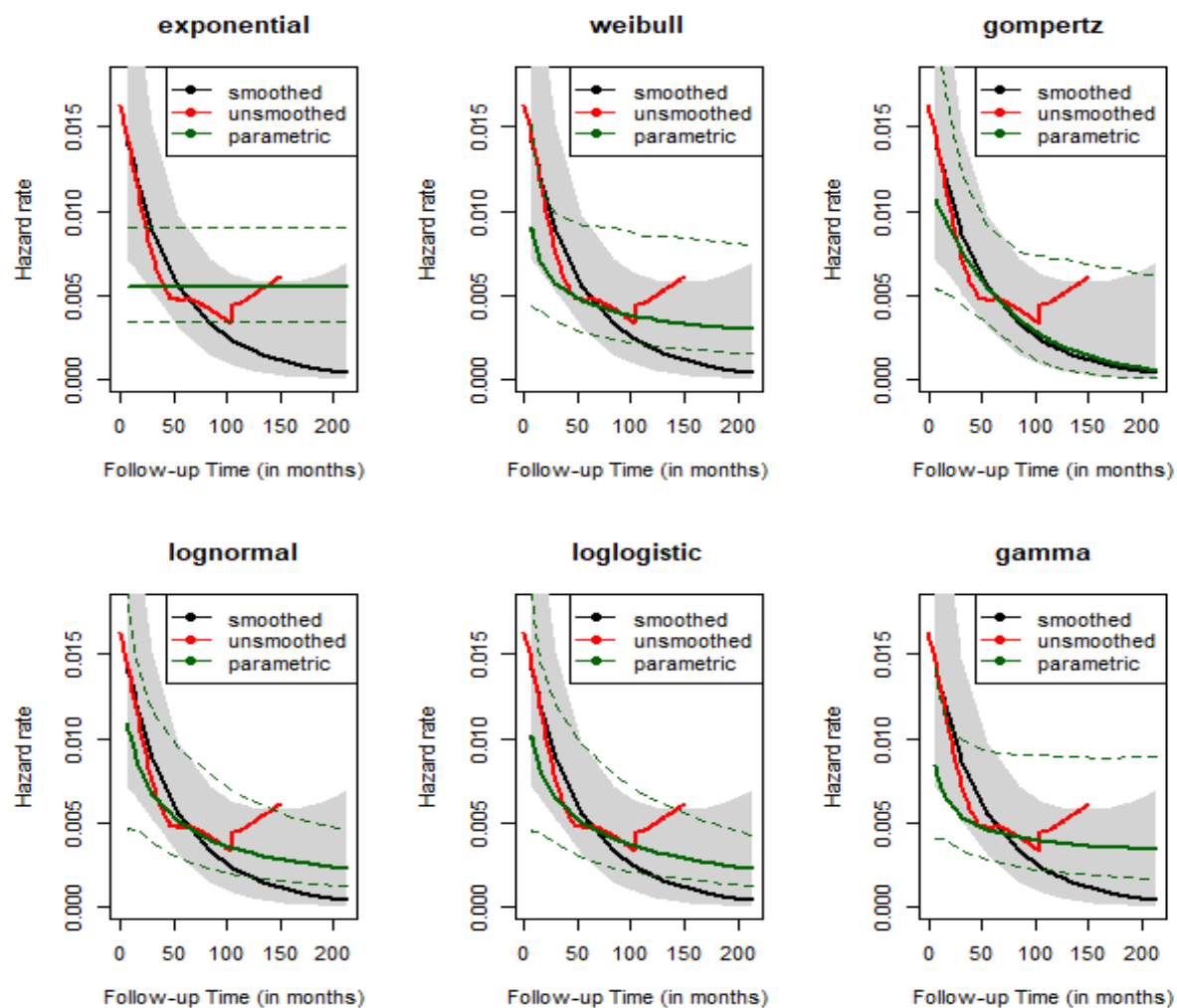

Source: Analysis of the TADPOLE trial (1).

Company evidence submission template for dabrafenib with trametinib for treating BRAF V600E mutation-positive glioma in children and young people aged 1 to 17 [ID5104]

© Novartis (2023). All rights reserved

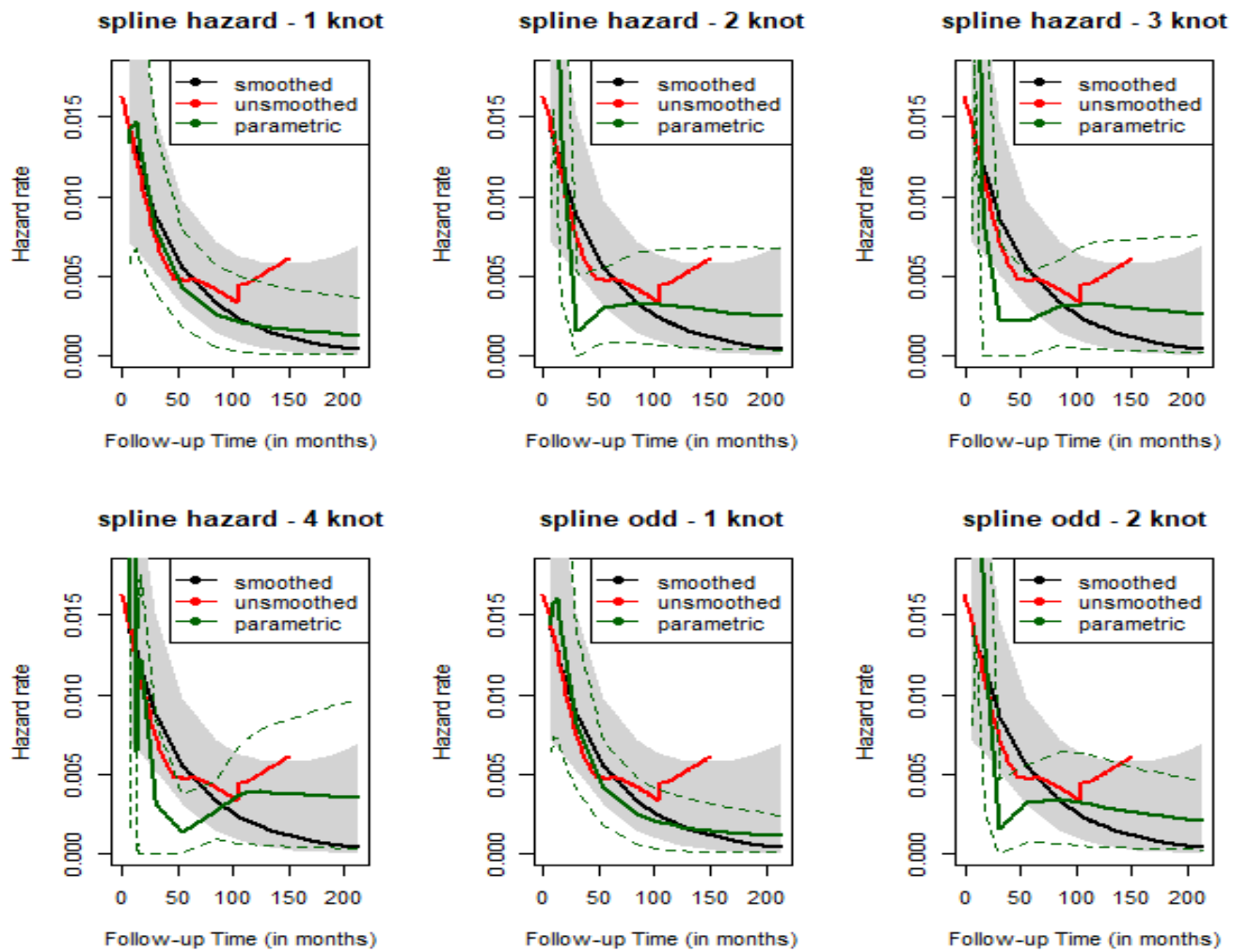

Source: Analysis of the TADPOLE trial (1).

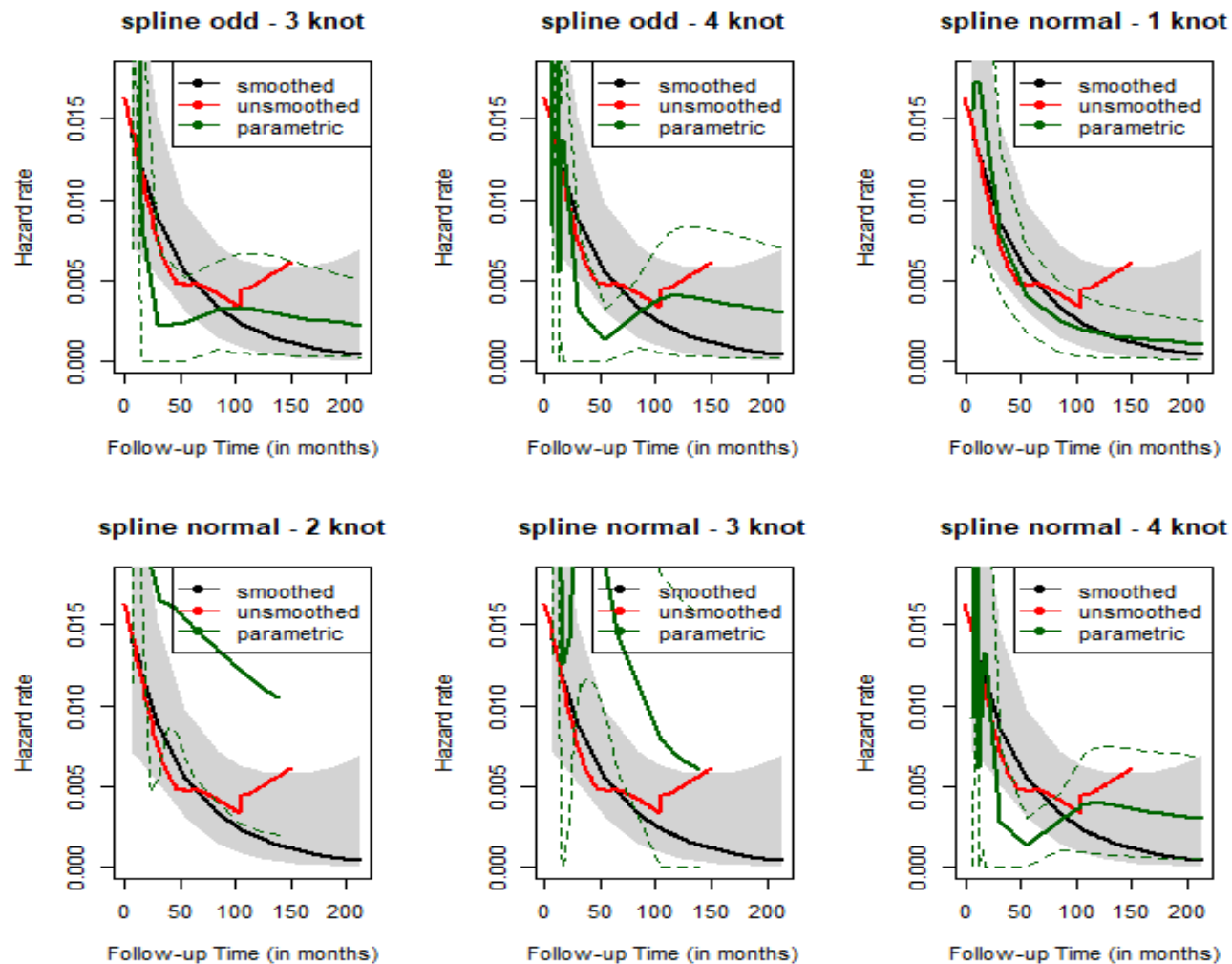

Source: Analysis of the TADPOLE trial (1).

P2 LGG: PFS C+V (independent review)

Figure 3: Fit to the KM

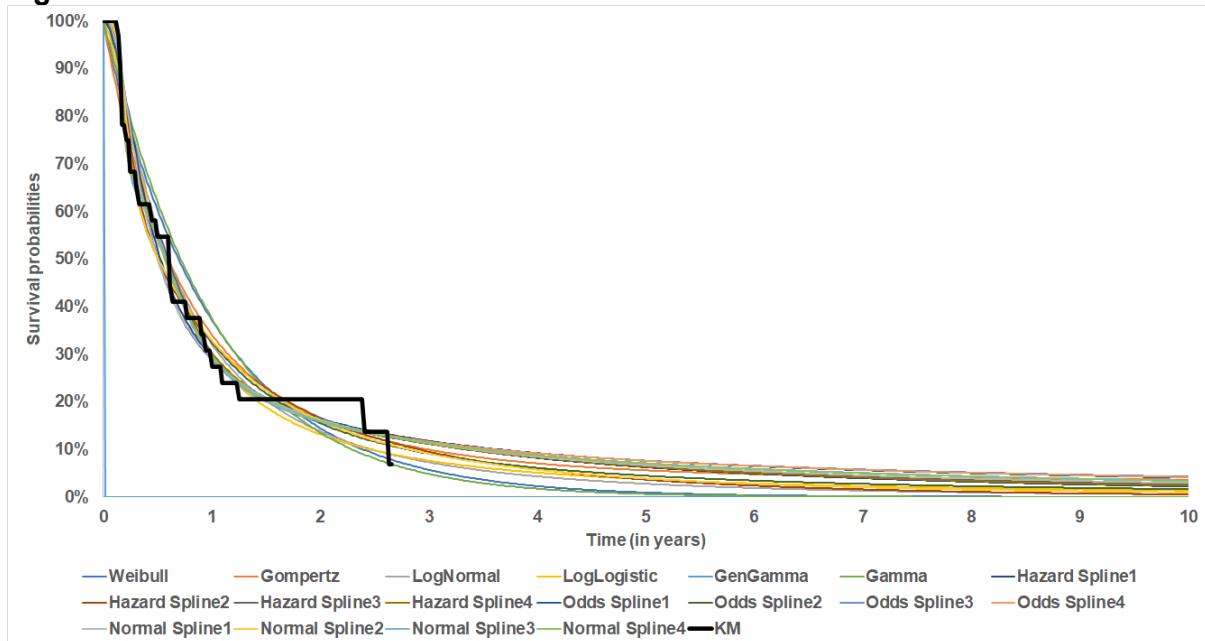

Source: Analysis of the TADPOLE trial (1).

Abbreviations: exp, exponential; gomp, Gompertz; genGamma, generalised gamma; KM, Kaplan-Meier; llog, log-logistic; lnorm, log-normal; Spline1: spline with 1 knot; Spline2: spline with 2 knots; Spline3: spline with 3 knots; Spline4: spline with 4 knots; weib, Weibull.

Table 2: Statistical fit

	AIC	BIC	Rank AIC	Rank BIC
Exponential	260.3	261.8	15.0	13.0
Weibull	262.3	265.3	17.0	17.0
Gompertz	260.8	263.8	16.0	16.0
LogNormal	255.9	258.9	10.0	3.0
LogLogistic	257.3	260.3	13.0	7.0
GenGamma	NA	NA	#VALUE!	#VALUE!
Gamma	262.3	265.3	18.0	18.0
Hazard Spline1	257.7	262.2	14.0	14.0
Hazard Spline2	256.7	262.7	11.0	15.0
Hazard Spline3	252.0	259.4	4.0	4.0
Hazard Spline4	252.4	261.4	6.0	10.0
Odds Spline1	257.2	261.7	12.0	12.0
Odds Spline2	255.7	261.7	9.0	11.0
Odds Spline3	251.4	258.9	3.0	2.0
Odds Spline4	252.1	261.1	5.0	9.0
Normal Spline1	255.4	259.9	8.0	5.0
Normal Spline2	254.5	260.5	7.0	8.0
Normal Spline3	250.3	257.7	1.0	1.0
Normal Spline4	251.1	260.1	2.0	6.0

Source: Analysis of the TADPOLE trial (1).

Abbreviations: AIC, Akaike Information Criterion; BIC, Bayesian Information Criterion; GenGamma, generalised gamma; N/A, not applicable, Spline1: spline with 1 knot; Spline2: spline with 2 knots; Spline3: spline with 3 knots; Spline4: spline with 4 knots.

Figure 4: Smoothed and unsmoothed hazard function

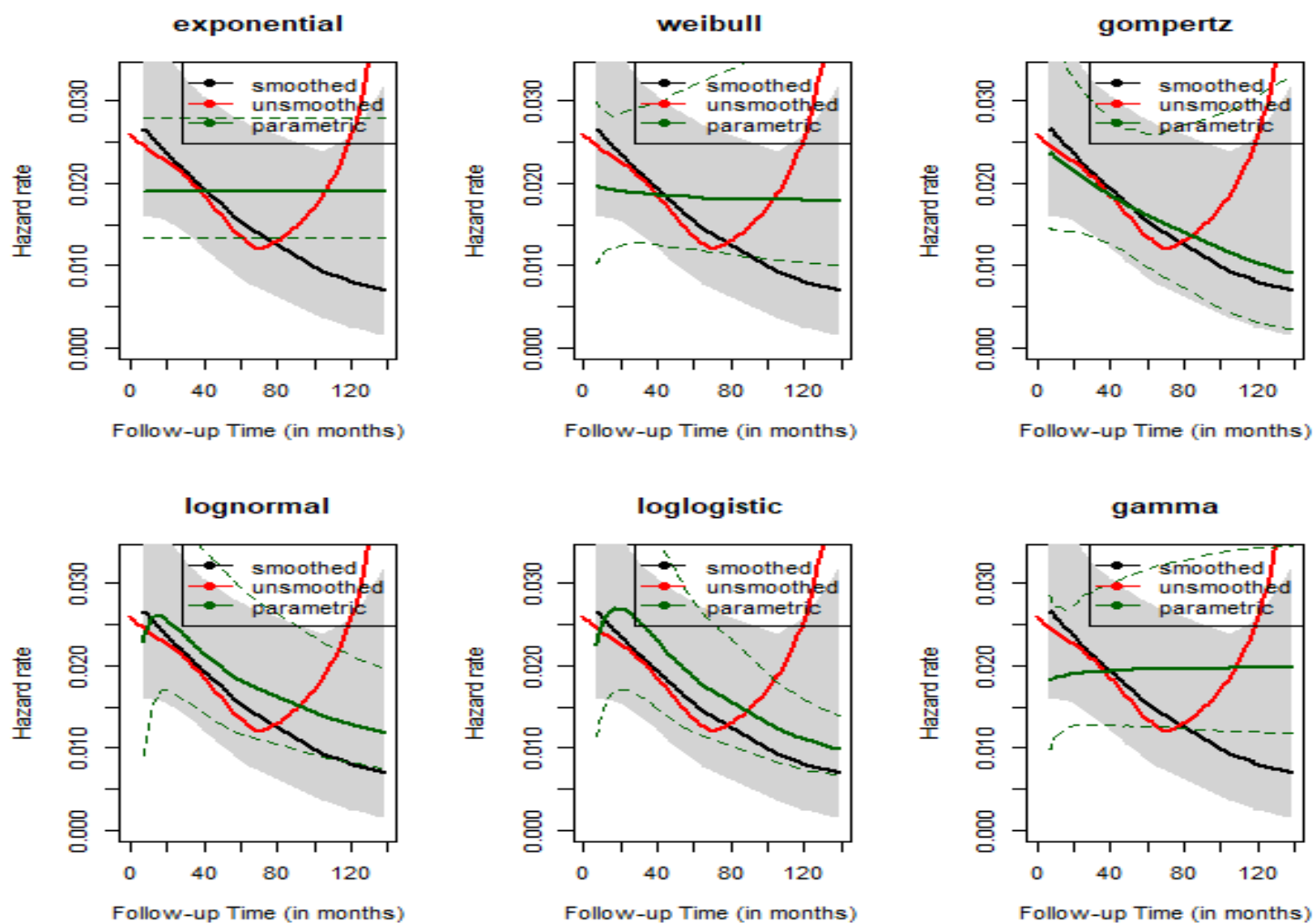

Source: Analysis of the TADPOLE trial (1).

Company evidence submission template for dabrafenib with trametinib for treating BRAF V600E mutation-positive glioma in children and young people aged 1 to 17 [ID5104]

© Novartis (2023). All rights reserved

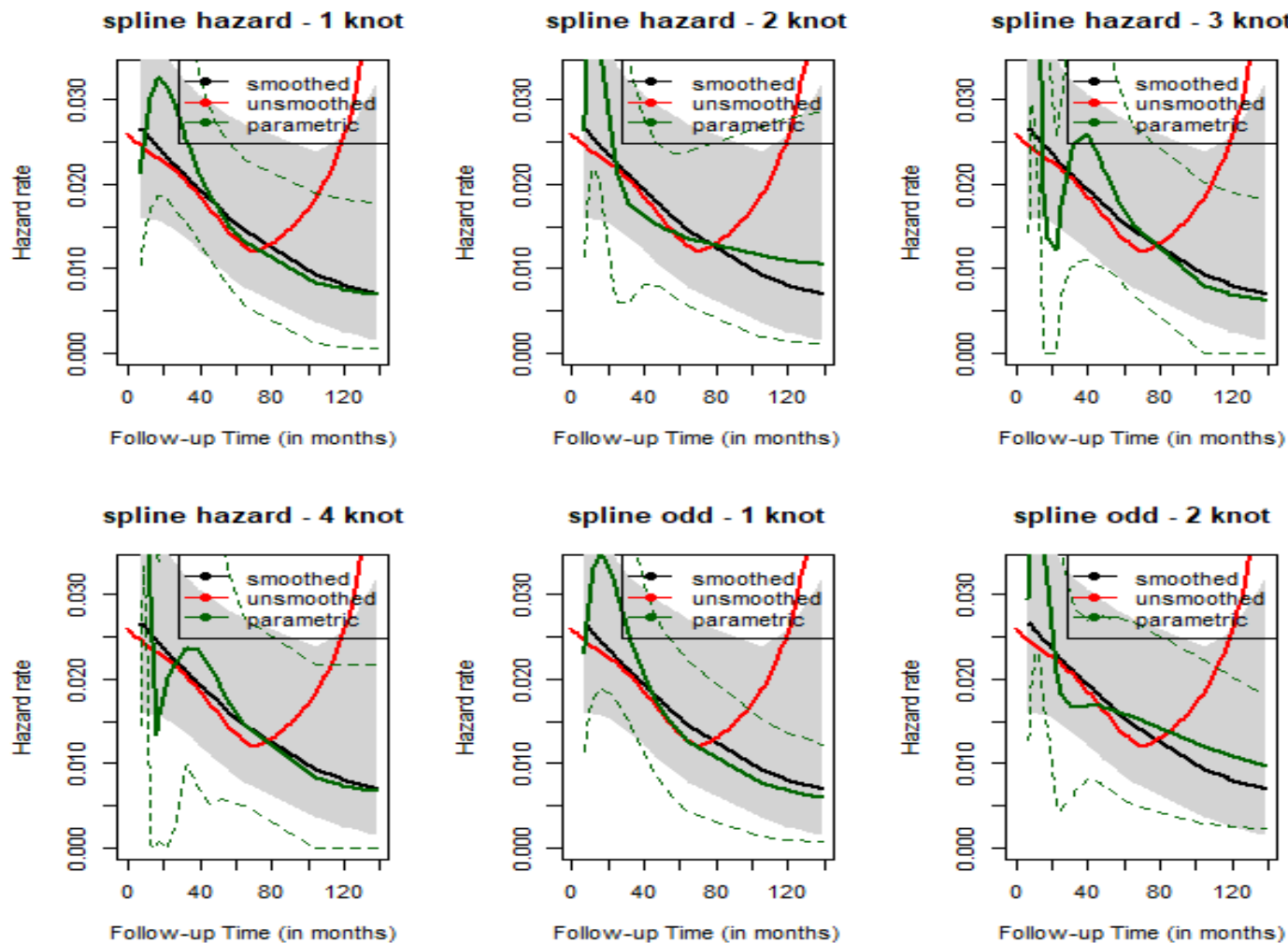

Source: Analysis of the TADPOLE trial (1).

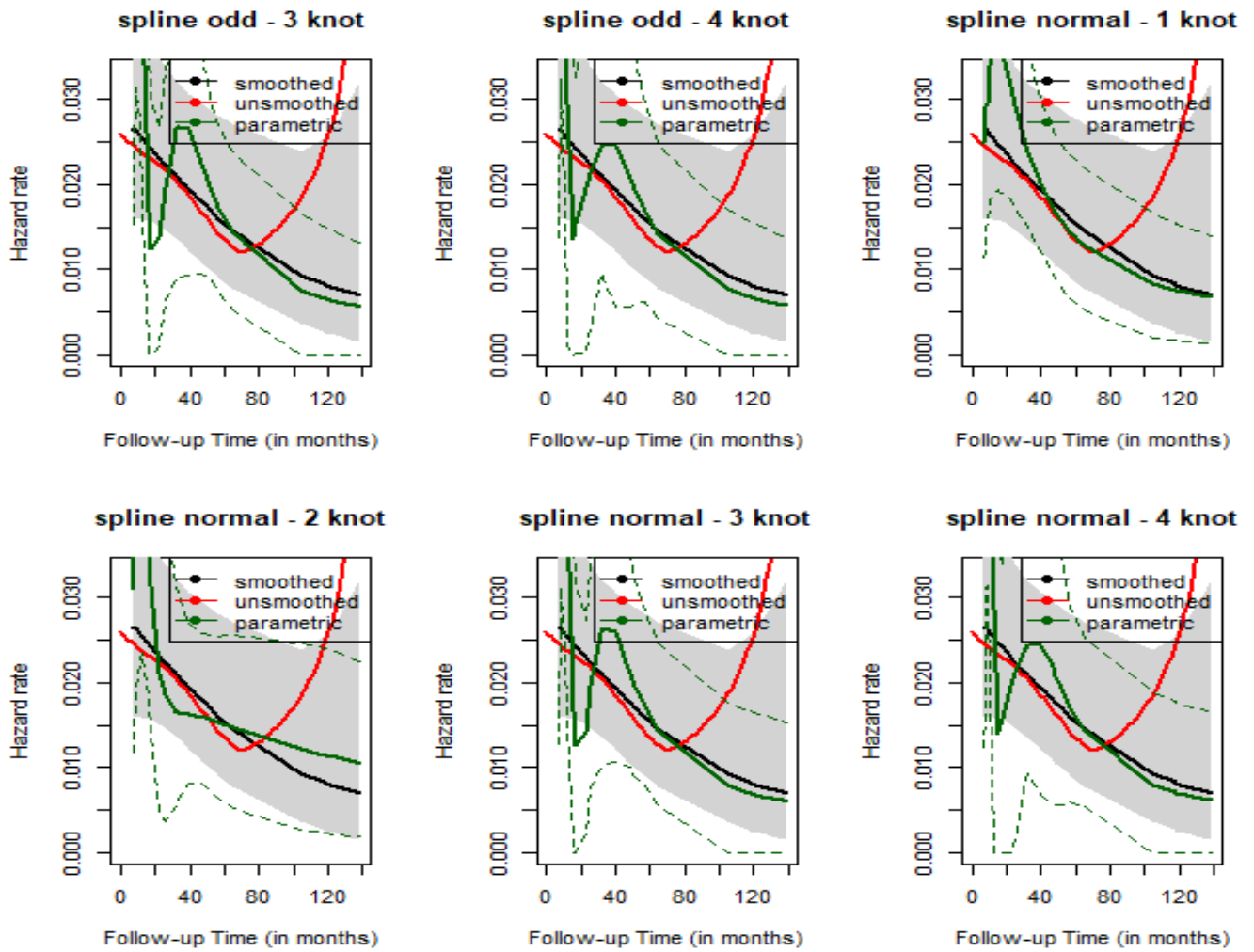

Source: Analysis of the TADPOLE trial (1).

P3 LGG: PFS D+T (independent review) - Additional (requested by EAG)

Figure 5: Fit to the KM

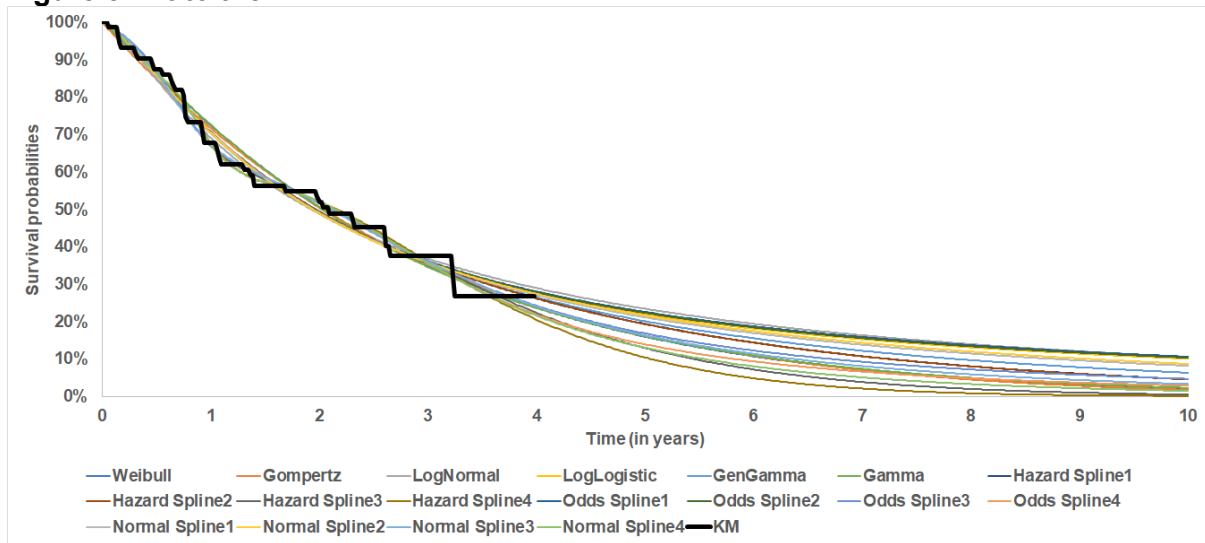

Source: Analysis of the TADPOLE trial (1).

Abbreviations: exp, exponential; gomp, Gompertz; genGamma, generalised gamma; KM, Kaplan-Meier; llog, log-logistic; lnorm, log-normal; Spline1: spline with 1 knot; Spline2: spline with 2 knots; Spline3: spline with 3 knots; Spline4: spline with 4 knots; weib, Weibull.

Table 3: Statistical fit

	AIC	BIC	Rank AIC	Rank BIC
Exponential	531.7	534.0	1.0	1.0
Weibull	533.4	538.0	5.0	5.0
Gompertz	533.7	538.2	6.0	6.0
LogNormal	533.1	537.7	3.0	3.0
LogLogistic	533.1	537.6	2.0	2.0
GenGamma	534.1	541.4	7.0	8.0
Gamma	533.2	537.8	4.0	4.0
Hazard Spline1	534.4	541.2	8.0	7.0
Hazard Spline2	536.4	545.6	17.0	11.0
Hazard Spline3	534.5	546.0	9.0	13.0
Hazard Spline4	535.2	549.0	14.0	19.0
Odds Spline1	535.0	541.9	12.0	10.0
Odds Spline2	537.0	546.2	19.0	14.0
Odds Spline3	535.3	546.8	15.0	15.0
Odds Spline4	535.2	548.9	13.0	18.0
Normal Spline1	534.7	541.5	10.0	9.0
Normal Spline2	536.6	545.8	18.0	12.0
Normal Spline3	535.5	547.0	16.0	16.0
Normal Spline4	534.7	548.4	11.0	17.0

Source: Analysis of the TADPOLE trial (1).

Abbreviations: AIC, Akaike Information Criterion; BIC, Bayesian Information Criterion; GenGamma, generalised gamma; N/A, not applicable, Spline1: spline with 1 knot; Spline2: spline with 2 knots; Spline3: spline with 3 knots; Spline4: spline with 4 knots.

Figure 6: Smoothed and unsmoothed hazard function

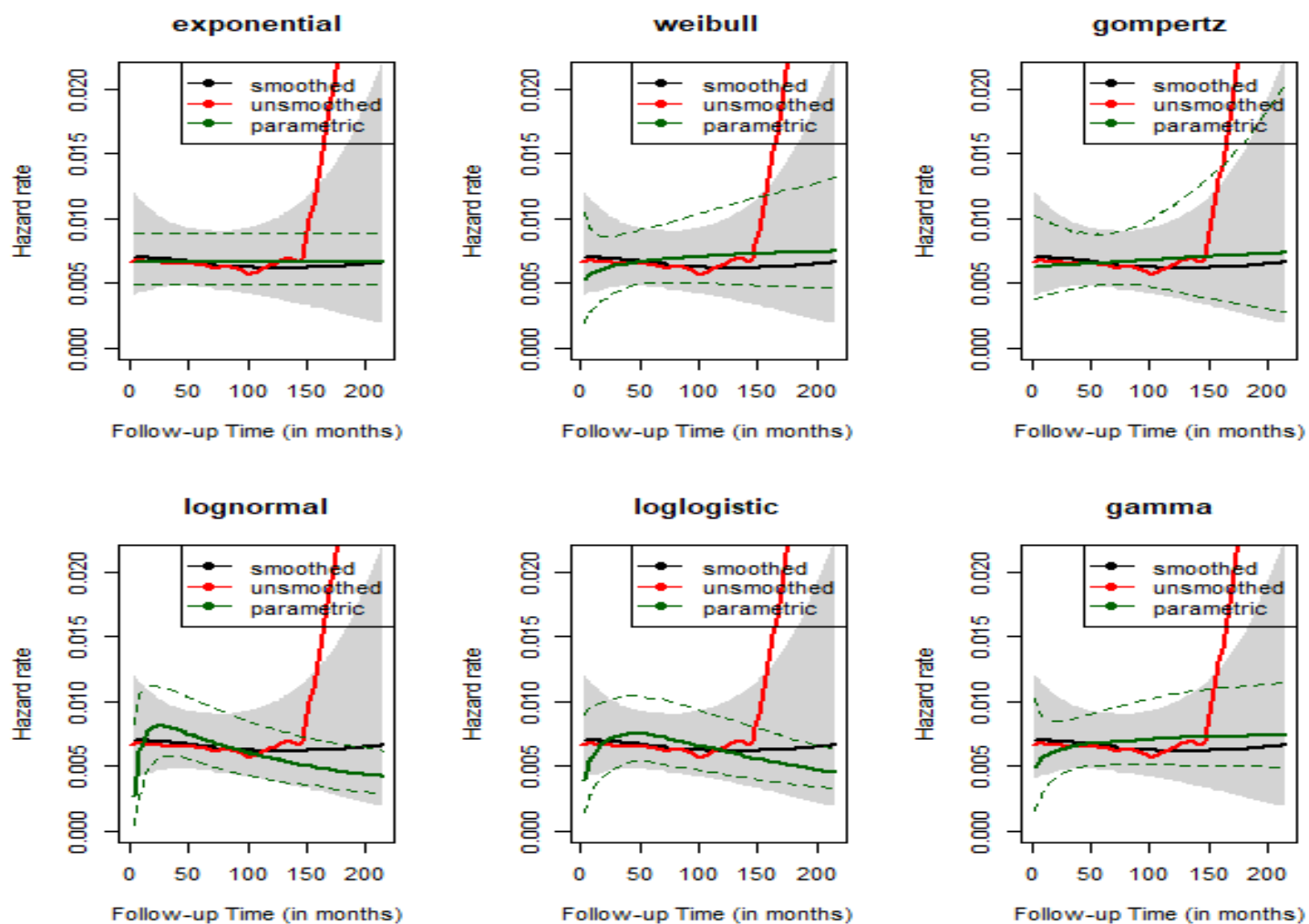

Source: Analysis of the TADPOLE trial (1).

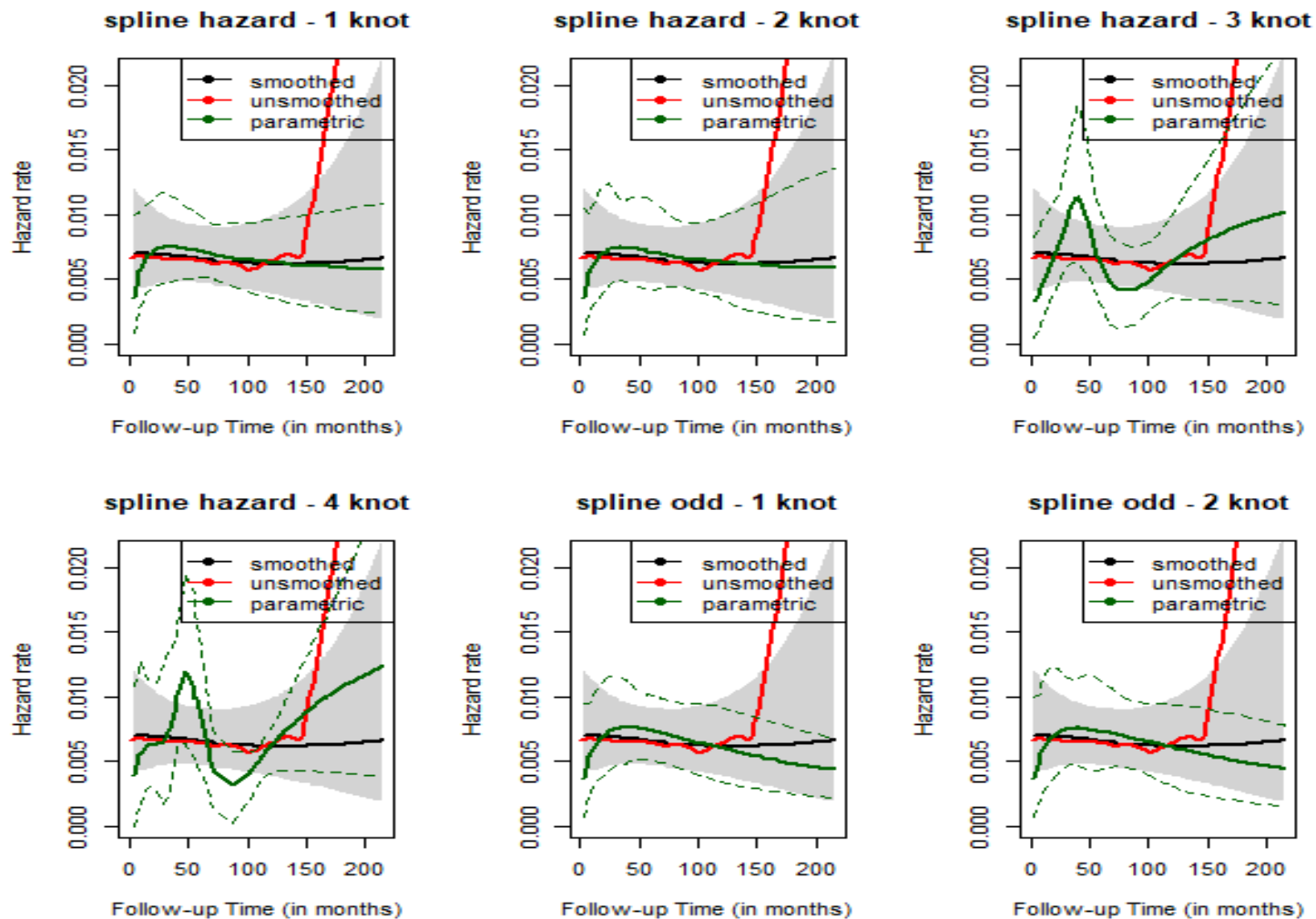

Source: Analysis of the TADPOLE trial (1).

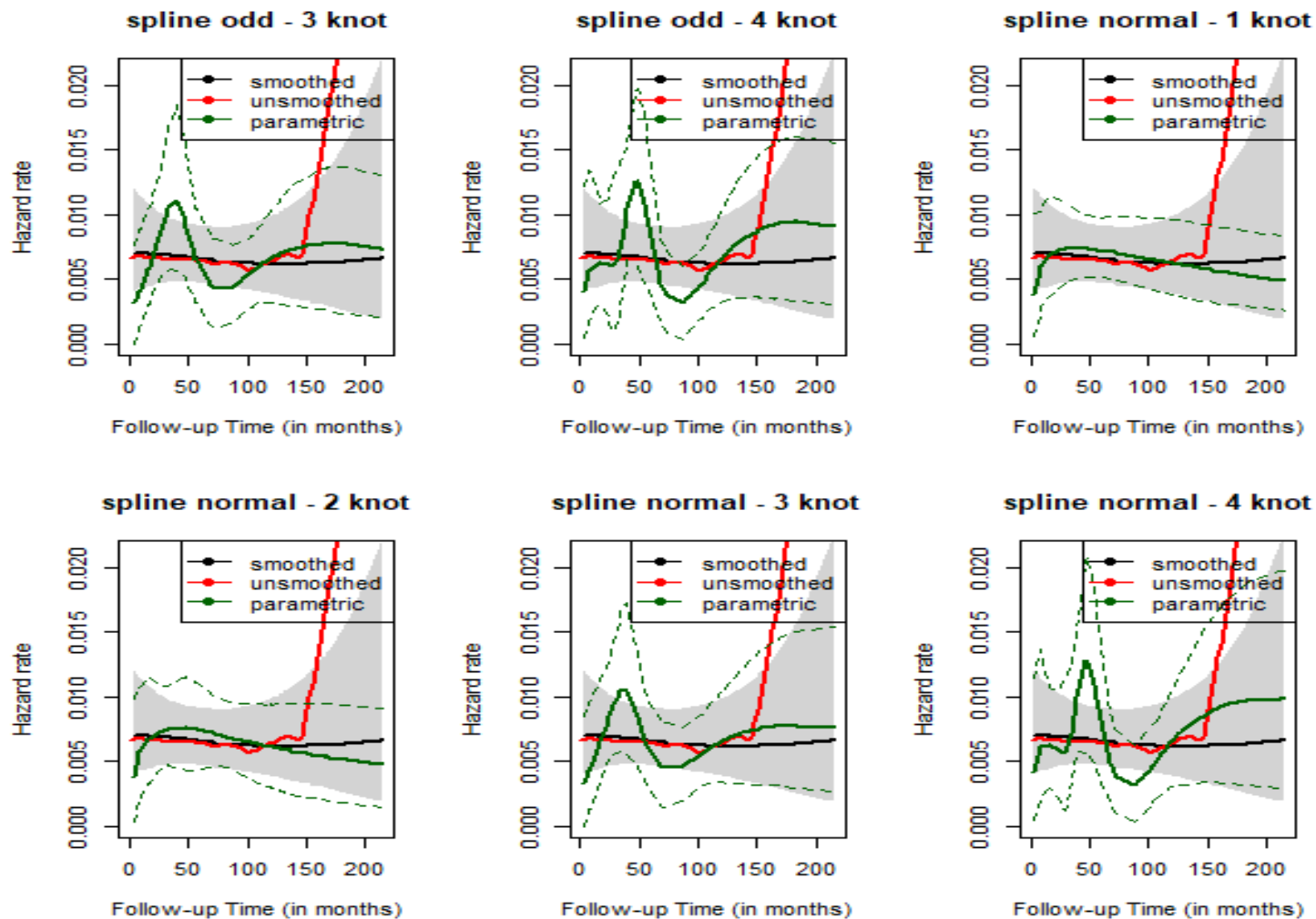

Source: Analysis of the TADPOLE trial (1).

Company evidence submission template for dabrafenib with trametinib for treating BRAF V600E mutation-positive glioma in children and young people aged 1 to 17 [ID5104]

© Novartis (2023). All rights reserved

P4 HGG: PFS D+T – no prior TMZ (investigator review)

Figure 7: Fit to the KM

Source: Analysis of the TADPOLE trial (1).

Abbreviations: exp, exponential; gomp, Gompertz; genGamma, generalised gamma; KM, Kaplan-Meier; llog, log-logistic; lnorm, log-normal; Spline1: spline with 1 knot; Spline2: spline with 2 knots; Spline3: spline with 3 knots; Spline4: spline with 4 knots; weib, Weibull.

Table 4: Statistical fit

	AIC	BIC	Rank AIC	Rank BIC
Exponential	107.0	107.9	1.0	1.0
Weibull	108.6	110.5	5.0	5.0
Gompertz	108.3	110.2	3.0	3.0
LogNormal	107.8	109.7	2.0	2.0
LogLogistic	108.3	110.2	4.0	4.0
GenGamma	NA	NA	#VALUE!	#VALUE!
Gamma	108.7	110.6	6.0	6.0
Hazard Spline1	109.7	112.6	9.0	8.0
Hazard Spline2	111.6	115.4	12.0	11.0
Hazard Spline3	113.5	118.2	15.0	14.0
Hazard Spline4	113.7	119.4	17.0	16.0
Odds Spline1	109.7	112.6	10.0	9.0
Odds Spline2	111.6	115.4	13.0	12.0
Odds Spline3	113.5	118.2	16.0	15.0
Odds Spline4	114.0	119.7	18.0	17.0
Normal Spline1	109.5	112.4	8.0	7.0
Normal Spline2	111.5	115.2	11.0	10.0
Normal Spline3	113.4	118.1	14.0	13.0
Normal Spline4	NA	NA	#VALUE!	#VALUE!

Source: Analysis of the TADPOLE trial (1).

Abbreviations: AIC, Akaike Information Criterion; BIC, Bayesian Information Criterion; GenGamma, generalised gamma; N/A, not applicable, Spline1: spline with 1 knot; Spline2: spline with 2 knots; Spline3: spline with 3 knots; Spline4: spline with 4 knots.

Figure 8: Smoothed and unsmoothed hazard function

█
Source: Analysis of the TADPOLE trial (1).

█
Source: Analysis of the TADPOLE trial (1).

█
Source: Analysis of the TADPOLE trial (1).

P5 HGG: PFS D+T – no prior TMZ (independent review)

Figure 9: Fit to the KM



Source: Analysis of the TADPOLE trial (1).

Abbreviations: exp, exponential; gomp, Gompertz; genGamma, generalised gamma; KM, Kaplan-Meier; llog, log-logistic; lnorm, log-normal; Spline1: spline with 1 knot; Spline2: spline with 2 knots; Spline3: spline with 3 knots; Spline4: spline with 4 knots; weib, Weibull

Table 5: Statistical fit

	AIC	BIC	Rank AIC	Rank BIC
Exponential	154.3	155.2	10.0	9.0
Weibull	155.7	157.6	15.0	12.0
Gompertz	153.6	155.5	9.0	10.0
LogNormal	152.8	154.7	7.0	7.0
LogLogistic	153.2	155.1	8.0	8.0
GenGamma	NA	NA	#VALUE!	#VALUE!
Gamma	156.1	158.0	18.0	15.0
Hazard Spline1	155.1	157.9	13.0	14.0
Hazard Spline2	155.7	159.5	16.0	17.0
Hazard Spline3	149.6	154.3	6.0	6.0
Hazard Spline4	128.1	133.7	3.0	3.0
Odds Spline1	154.9	157.7	12.0	13.0
Odds Spline2	155.7	159.5	17.0	18.0
Odds Spline3	146.9	151.6	5.0	5.0
Odds Spline4	126.4	132.1	1.0	1.0
Normal Spline1	154.5	157.3	11.0	11.0
Normal Spline2	155.3	159.0	14.0	16.0
Normal Spline3	145.7	150.4	4.0	4.0
Normal Spline4	126.4	132.1	2.0	2.0

Source: Analysis of the TADPOLE trial (1).

Abbreviations: AIC, Akaike Information Criterion; BIC, Bayesian Information Criterion; GenGamma, generalised gamma; N/A, not applicable, Spline1: spline with 1 knot; Spline2: spline with 2 knots; Spline3: spline with 3 knots; Spline4: spline with 4 knots.

Figure 10: Smoothed and unsmoothed hazard function

Source: Analysis of the TADPOLE trial (1).

█
Source: Analysis of the TADPOLE trial (1).

■
Source: Analysis of the TADPOLE trial (1).

***P6 HGG: PFS D+T – no prior TMZ (independent review) – IPTW
adjusted (MAIC)***

Figure 11: Fit to the KM



Source: Analysis of the TADPOLE trial (1).

Abbreviations: exp, exponential; gomp, Gompertz; genGamma, generalised gamma; KM, Kaplan-Meier; llog, log-logistic; lnorm, log-normal; Spline1: spline with 1 knot; Spline2: spline with 2 knots; Spline3: spline with 3 knots; Spline4: spline with 4 knots; weib, Weibull.

Table 6: Statistical fit

	AIC	BIC	Rank AIC	Rank BIC
Exponential	99.1	99.9	6.0	6.0
Weibull	101.1	102.6	11.0	10.0
Gompertz	100.3	101.9	9.0	9.0
LogNormal	99.5	101.0	7.0	7.0
LogLogistic	99.9	101.5	8.0	8.0
GenGamma	100.8	103.1	10.0	12.0
Gamma	101.1	102.7	12.0	11.0
Hazard Spline1	101.7	104.0	15.0	15.0
Hazard Spline2	103.2	106.3	17.0	17.0
Hazard Spline3	83.5	87.3	5.0	5.0
Hazard Spline4	67.9	72.5	3.0	3.0
Odds Spline1	101.6	103.9	14.0	14.0
Odds Spline2	103.4	106.5	18.0	18.0
Odds Spline3	82.4	86.3	4.0	4.0
Odds Spline4	66.6	71.2	2.0	2.0
Normal Spline1	101.3	103.6	13.0	13.0
Normal Spline2	103.1	106.2	16.0	16.0
Normal Spline3	NA	NA	#VALUE!	#VALUE!
Normal Spline4	65.7	70.4	1.0	1.0

Source: Analysis of the TADPOLE trial (1).

Abbreviations: AIC, Akaike Information Criterion; BIC, Bayesian Information Criterion; GenGamma, generalised gamma; N/A, not applicable, Spline1: spline with 1 knot; Spline2: spline with 2 knots; Spline3: spline with 3 knots; Spline4: spline with 4 knots.

Figure 12: Smoothed and unsmoothed hazard function

Source: Analysis of the TADPOLE trial (1).

█

Source: Analysis of the TADPOLE trial (1).

█

Source: Analysis of the TADPOLE trial (1).

***P7 HGG: PFS TMZ – no prior TMZ (independent review) – IPTW
adjusted (MAIC)***

Figure 13: Fit to the KM



Source: Analysis of the TADPOLE trial (1).

Abbreviations: exp, exponential; gomp, Gompertz; genGamma, generalised gamma; KM, Kaplan-Meier; llog, log-logistic; lnorm, log-normal; Spline1: spline with 1 knot; Spline2: spline with 2 knots; Spline3: spline with 3 knots; Spline4: spline with 4 knots; weib, Weibull.

Table 7: Statistical fit

	AIC	BIC	Rank AIC	Rank BIC
Exponential	76.3	76.7	6.0	5.0
Weibull	75.6	76.4	4.0	4.0
Gompertz	77.1	77.9	9.0	9.0
LogNormal	74.0	74.7	1.0	1.0
LogLogistic	74.6	75.4	2.0	2.0
GenGamma	NA	NA	#VALUE!	#VALUE!
Gamma	74.9	75.7	3.0	3.0
Hazard Spline1	76.4	77.6	7.0	7.0
Hazard Spline2	78.4	79.9	11.0	11.0
Hazard Spline3	80.1	82.1	14.0	14.0
Hazard Spline4	NA	NA	#VALUE!	#VALUE!
Odds Spline1	76.6	77.8	8.0	8.0
Odds Spline2	78.6	80.2	12.0	12.0
Odds Spline3	80.2	82.2	15.0	15.0
Odds Spline4	NA	NA	#VALUE!	#VALUE!
Normal Spline1	75.9	77.1	5.0	6.0
Normal Spline2	77.9	79.5	10.0	10.0
Normal Spline3	79.6	81.6	13.0	13.0
Normal Spline4	NA	NA	#VALUE!	#VALUE!

Source: Analysis of the TADPOLE trial (1).

Abbreviations: AIC, Akaike Information Criterion; BIC, Bayesian Information Criterion; GenGamma, generalised gamma; N/A, not applicable, Spline1: spline with 1 knot; Spline2: spline with 2 knots; Spline3: spline with 3 knots; Spline4: spline with 4 knots.

Figure 14: Smoothed and unsmoothed hazard function

Source: Analysis of the TADPOLE trial (1).

■
Source: Analysis of the TADPOLE trial (1).

■
Source: Analysis of the TADPOLE trial (1).

P8 HGG: PFS D+T – prior TMZ (investigator review)

Figure 15: Fit to the KM



Source: Analysis of the TADPOLE trial (1).

Abbreviations: exp, exponential; gomp, Gompertz; genGamma, generalised gamma; KM, Kaplan-Meier; llog, log-logistic; lnorm, log-normal; Spline1: spline with 1 knot; Spline2: spline with 2 knots; Spline3: spline with 3 knots; Spline4: spline with 4 knots; weib, Weibull.

Table 8: Statistical fit

	AIC	BIC	Rank AIC	Rank BIC
Exponential	185.3	186.4	12.0	6.0
Weibull	183.3	185.5	5.0	4.0
Gompertz	182.9	185.1	3.0	3.0
LogNormal	181.5	183.7	1.0	1.0
LogLogistic	182.3	184.5	2.0	2.0
GenGamma	NA	186.4	#VALUE!	7.0
Gamma	183.9	186.1	8.0	5.0
Hazard Spline1	183.6	186.8	6.0	9.0
Hazard Spline2	184.1	188.5	10.0	12.0
Hazard Spline3	186.4	191.8	15.0	16.0
Hazard Spline4	186.7	193.2	16.0	17.0
Odds Spline1	183.7	187.0	7.0	10.0
Odds Spline2	184.1	188.4	9.0	11.0
Odds Spline3	185.9	191.4	14.0	15.0
Odds Spline4	187.0	193.6	17.0	18.0
Normal Spline1	183.2	186.5	4.0	8.0
Normal Spline2	184.1	188.5	11.0	13.0
Normal Spline3	185.8	191.2	13.0	14.0
Normal Spline4	187.1	193.6	18.0	19.0

Source: Analysis of the TADPOLE trial (1).

Abbreviations: AIC, Akaike Information Criterion; BIC, Bayesian Information Criterion; GenGamma, generalised gamma; N/A, not applicable, Spline1: spline with 1 knot; Spline2: spline with 2 knots; Spline3: spline with 3 knots; Spline4: spline with 4 knots.

Figure 16: Smoothed and unsmoothed hazard function

Source: Analysis of the TADPOLE trial (1).

■
Source: Analysis of the TADPOLE trial (1).

■
Source: Analysis of the TADPOLE trial (1).

P9 HGG: PFS D+T – prior TMZ (independent review)

Figure 17: Fit to the KM

Source: Analysis of the TADPOLE trial (1).

Abbreviations: exp, exponential; gomp, Gompertz; genGamma, generalised gamma; KM, Kaplan-Meier; llog, log-logistic; lnorm, log-normal; Spline1: spline with 1 knot; Spline2: spline with 2 knots; Spline3: spline with 3 knots; Spline4: spline with 4 knots; weib, Weibull.

Table 9: Statistical fit

	AIC	BIC	Rank AIC	Rank BIC
Exponential	151.5	152.5	18.0	14.0
Weibull	149.9	152.0	16.0	13.0
Gompertz	144.4	146.6	1.0	1.0
LogNormal	146.7	148.9	9.0	2.0
LogLogistic	147.4	149.6	12.0	5.0
GenGamma	147.3	150.6	11.0	10.0
Gamma	150.9	153.0	17.0	15.0
Hazard Spline1	145.8	149.0	2.0	3.0
Hazard Spline2	146.2	150.5	6.0	9.0
Hazard Spline3	146.6	152.0	7.0	11.0
Hazard Spline4	148.2	154.8	13.0	16.0
Odds Spline1	146.1	149.4	5.0	4.0
Odds Spline2	146.0	150.3	4.0	7.0
Odds Spline3	146.6	152.0	8.0	12.0
Odds Spline4	148.5	155.1	14.0	17.0
Normal Spline1	147.2	150.4	10.0	8.0
Normal Spline2	145.8	150.2	3.0	6.0
Normal Spline3	NA	NA	#VALUE!	#VALUE!
Normal Spline4	148.9	155.5	15.0	18.0

Source: Analysis of the TADPOLE trial (1).

Abbreviations: AIC, Akaike Information Criterion; BIC, Bayesian Information Criterion; GenGamma, generalised gamma; N/A, not applicable, Spline1: spline with 1 knot; Spline2: spline with 2 knots; Spline3: spline with 3 knots; Spline4: spline with 4 knots.

Figure 18: Smoothed and unsmoothed hazard function

Source: Analysis of the TADPOLE trial (1).

■
Source: Analysis of the TADPOLE trial (1).

■
Source: Analysis of the TADPOLE trial (1).

P10 TTD D+T – LGG

Figure 19: Fit to the KM

Source: Analysis of the TADPOLE trial (1).

Abbreviations: exp, exponential; gomp, Gompertz; genGamma, generalised gamma; KM, Kaplan-Meier; llog, log-logistic; lnorm, log-normal; Spline1: spline with 1 knot; Spline2: spline with 2 knots; Spline3: spline with 3 knots; Spline4: spline with 4 knots; weib, Weibull.

Table 10: Statistical fit

	AIC	BIC	Rank AIC	Rank BIC
Exponential	21	22	1	1
Weibull	NA	NA	#VALUE!	#VALUE!
Gompertz	21	24	2	2
LogNormal	22	25	3	3
LogLogistic	22	25	4	4
GenGamma	NA	NA	#VALUE!	#VALUE!
Gamma	22	26	5	5
Hazard Spline1	NA	NA	#VALUE!	#VALUE!
Hazard Spline2	NA	NA	#VALUE!	#VALUE!
Hazard Spline3	NA	NA	#VALUE!	#VALUE!
Hazard Spline4	NA	NA	#VALUE!	#VALUE!
Odds Spline1	NA	NA	#VALUE!	#VALUE!
Odds Spline2	NA	NA	#VALUE!	#VALUE!
Odds Spline3	NA	NA	#VALUE!	#VALUE!
Odds Spline4	NA	NA	#VALUE!	#VALUE!
Normal Spline1	NA	NA	#VALUE!	#VALUE!
Normal Spline2	NA	NA	#VALUE!	#VALUE!
Normal Spline3	NA	NA	#VALUE!	#VALUE!
Normal Spline4	NA	NA	#VALUE!	#VALUE!

Source: Analysis of the TADPOLE trial (1).

Abbreviations: AIC, Akaike Information Criterion; BIC, Bayesian Information Criterion; GenGamma, generalised gamma; N/A, not applicable, Spline1: spline with 1 knot; Spline2: spline with 2 knots; Spline3: spline with 3 knots; Spline4: spline with 4 knots.

Figure 20: Smoothed and unsmoothed hazard function

Source: Analysis of the TADPOLE trial (1).

■
Source: Analysis of the TADPOLE trial (1).

■
Source: Analysis of the TADPOLE trial (1).

P11 TTD D+T – HGG

Figure 21: Fit to the KM



Source: Analysis of the TADPOLE trial (1).

Abbreviations: exp, exponential; gomp, Gompertz; genGamma, generalised gamma; KM, Kaplan-Meier; llog, log-logistic; lnorm, log-normal; Spline1: spline with 1 knot; Spline2: spline with 2 knots; Spline3: spline with 3 knots; Spline4: spline with 4 knots; weib, Weibull.

Table 11: Statistical fit

	AIC	BIC	Rank AIC	Rank BIC
Exponential	20.7	22.4	1.0	1.0
Weibull	NA	NA	#VALUE!	#VALUE!
Gompertz	20.7	24.2	2.0	2.0
LogNormal	21.9	25.3	3.0	3.0
LogLogistic	22.1	25.5	4.0	4.0
GenGamma	NA	NA	#VALUE!	#VALUE!
Gamma	22.1	25.5	5.0	5.0
Hazard Spline1	NA	NA	#VALUE!	#VALUE!
Hazard Spline2	NA	NA	#VALUE!	#VALUE!
Hazard Spline3	NA	NA	#VALUE!	#VALUE!
Hazard Spline4	NA	NA	#VALUE!	#VALUE!
Odds Spline1	NA	NA	#VALUE!	#VALUE!
Odds Spline2	NA	NA	#VALUE!	#VALUE!
Odds Spline3	NA	NA	#VALUE!	#VALUE!
Odds Spline4	NA	NA	#VALUE!	#VALUE!
Normal Spline1	NA	NA	#VALUE!	#VALUE!
Normal Spline2	NA	NA	#VALUE!	#VALUE!
Normal Spline3	NA	NA	#VALUE!	#VALUE!
Normal Spline4	NA	NA	#VALUE!	#VALUE!

Source: Analysis of the TADPOLE trial (1).

Abbreviations: AIC, Akaike Information Criterion; BIC, Bayesian Information Criterion; GenGamma, generalised gamma; N/A, not applicable, Spline1: spline with 1 knot; Spline2: spline with 2 knots; Spline3: spline with 3 knots; Spline4: spline with 4 knots.

Figure 22: Smoothed and unsmoothed hazard function

Source: Analysis of the TADPOLE trial (1).

■
Source: Analysis of the TADPOLE trial (1).

■
Source: Analysis of the TADPOLE trial (1).

P12 PPS D+T – HGG (investigator review)

Figure 23: Fit to the KM

Source: Analysis of the TADPOLE trial (1).

Abbreviations: exp, exponential; gomp, Gompertz; genGamma, generalised gamma; KM, Kaplan-Meier; llog, log-logistic; lnorm, log-normal; Spline1: spline with 1 knot; Spline2: spline with 2 knots; Spline3: spline with 3 knots; Spline4: spline with 4 knots; weib, Weibull.

Table 12: Statistical fit

	AIC	BIC	Rank AIC	Rank BIC
Exponential	156.0	157.2	1.0	1.0
Weibull	157.7	160.1	6.0	5.0
Gompertz	158.0	160.5	7.0	6.0
LogNormal	156.3	158.8	2.0	2.0
LogLogistic	157.0	159.4	3.0	3.0
GenGamma	158.3	162.0	8.0	7.0
Gamma	157.5	159.9	5.0	4.0
Hazard Spline1	158.7	162.4	12.0	10.0
Hazard Spline2	158.4	163.3	11.0	13.0
Hazard Spline3	159.9	166.0	16.0	15.0
Hazard Spline4	160.1	167.5	17.0	18.0
Odds Spline1	158.9	162.6	13.0	11.0
Odds Spline2	157.4	162.2	4.0	9.0
Odds Spline3	159.6	165.7	14.0	14.0
Odds Spline4	159.7	167.0	15.0	17.0
Normal Spline1	158.3	162.0	9.0	8.0
Normal Spline2	158.4	163.2	10.0	12.0
Normal Spline3	160.5	166.6	18.0	16.0
Normal Spline4	NA	NA	#VALUE!	#VALUE!

Source: Analysis of the TADPOLE trial (1).

Abbreviations: AIC, Akaike Information Criterion; BIC, Bayesian Information Criterion; GenGamma, generalised gamma; N/A, not applicable, Spline1: spline with 1 knot; Spline2: spline with 2 knots; Spline3: spline with 3 knots; Spline4: spline with 4 knots.

Figure 24: Smoothed and unsmoothed hazard function

Source: Analysis of the TADPOLE trial (1).

█
Source: Analysis of the TADPOLE trial (1).

■
Source: Analysis of the TADPOLE trial (1).

P13 PPS D+T – HGG (independent review)

Figure 25: Fit to the KM



Source: Analysis of the TADPOLE trial (1).

Abbreviations: exp, exponential; gomp, Gompertz; genGamma, generalised gamma; KM, Kaplan-Meier; llog, log-logistic; lnorm, log-normal; Spline1: spline with 1 knot; Spline2: spline with 2 knots; Spline3: spline with 3 knots; Spline4: spline with 4 knots; weib, Weibull.

Table 13: Statistical fit

	AIC	BIC	Rank AIC	Rank BIC
Exponential	168.8	170.1	7.0	2.0
Weibull	170.3	172.9	12.0	8.0
Gompertz	168.0	170.6	5.0	3.0
LogNormal	167.3	169.9	2.0	1.0
LogLogistic	168.5	171.1	6.0	5.0
GenGamma	NA	NA	#VALUE!	#VALUE!
Gamma	170.6	173.2	17.0	9.0
Hazard Spline1	167.6	171.5	4.0	7.0
Hazard Spline2	169.3	174.5	10.0	12.0
Hazard Spline3	170.4	176.9	15.0	14.0
Hazard Spline4	170.9	178.7	18.0	18.0
Odds Spline1	167.4	171.2	3.0	6.0
Odds Spline2	169.2	174.4	9.0	11.0
Odds Spline3	170.5	176.9	16.0	15.0
Odds Spline4	170.4	178.1	14.0	17.0
Normal Spline1	167.0	170.8	1.0	4.0
Normal Spline2	168.9	174.1	8.0	10.0
Normal Spline3	170.3	176.8	13.0	13.0
Normal Spline4	170.2	178.0	11.0	16.0

Source: Analysis of the TADPOLE trial (1).

Abbreviations: AIC, Akaike Information Criterion; BIC, Bayesian Information Criterion; GenGamma, generalised gamma; N/A, not applicable, Spline1: spline with 1 knot; Spline2: spline with 2 knots; Spline3: spline with 3 knots; Spline4: spline with 4 knots.

Figure 26: Smoothed and unsmoothed hazard function

Source: Analysis of the TADPOLE trial (1).

■
Source: Analysis of the TADPOLE trial (1).

■
Source: Analysis of the TADPOLE trial (1).

P14 PFS sHGG – LGG analysis

Figure 27: Fit to the KM

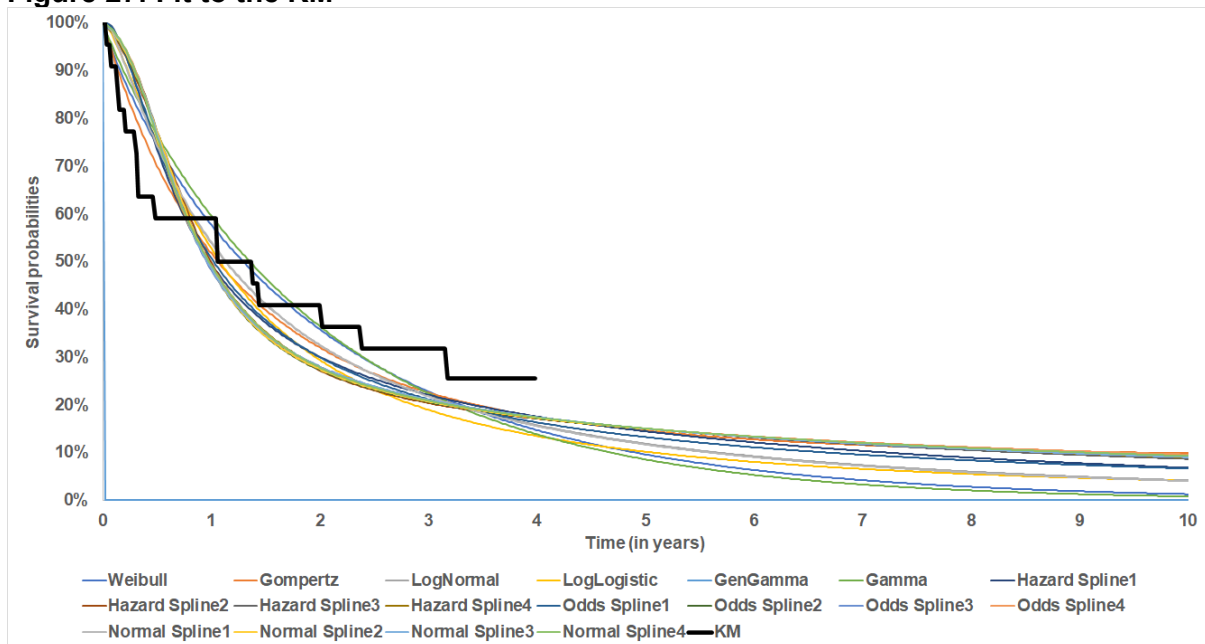

Source: derived from Jakacki 2016 (2).

Abbreviations: exp, exponential; gomp, Gompertz; genGamma, generalised gamma; KM, Kaplan-Meier; llog, log-logistic; lnorm, log-normal; Spline1: spline with 1 knot; Spline2: spline with 2 knots; Spline3: spline with 3 knots; Spline4: spline with 4 knots; weib, Weibull.

Table 14: Statistical fit

	AIC	BIC	Rank AIC	Rank BIC
Exponential	1,005.1	1,007.8	17.0	17.0
Weibull	1,005.4	1,010.8	18.0	18.0
Gompertz	993.9	999.3	16.0	11.0
LogNormal	991.5	996.9	13.0	8.0
LogLogistic	986.9	992.3	12.0	1.0
GenGamma	993.5	1,001.5	14.0	14.0
Gamma	1,006.9	1,012.2	19.0	19.0
Hazard Spline1	986.6	994.6	11.0	6.0
Hazard Spline2	983.6	994.3	4.0	5.0
Hazard Spline3	984.1	997.6	6.0	10.0
Hazard Spline4	985.6	1,001.7	9.0	16.0
Odds Spline1	985.6	993.7	10.0	4.0
Odds Spline2	982.4	993.2	2.0	3.0
Odds Spline3	983.7	997.2	5.0	9.0
Odds Spline4	985.3	1,001.4	7.0	12.0
Normal Spline1	993.5	1,001.5	15.0	15.0
Normal Spline2	981.9	992.7	1.0	2.0
Normal Spline3	983.5	996.9	3.0	7.0

Source: derived from Jakacki 2016 (2).

Abbreviations: AIC, Akaike Information Criterion; BIC, Bayesian Information Criterion; GenGamma, generalised gamma; N/A, not applicable, Spline1: spline with 1 knot; Spline2: spline with 2 knots; Spline3: spline with 3 knots; Spline4: spline with 4 knots.

Figure 28: Smoothed and unsmoothed hazard function

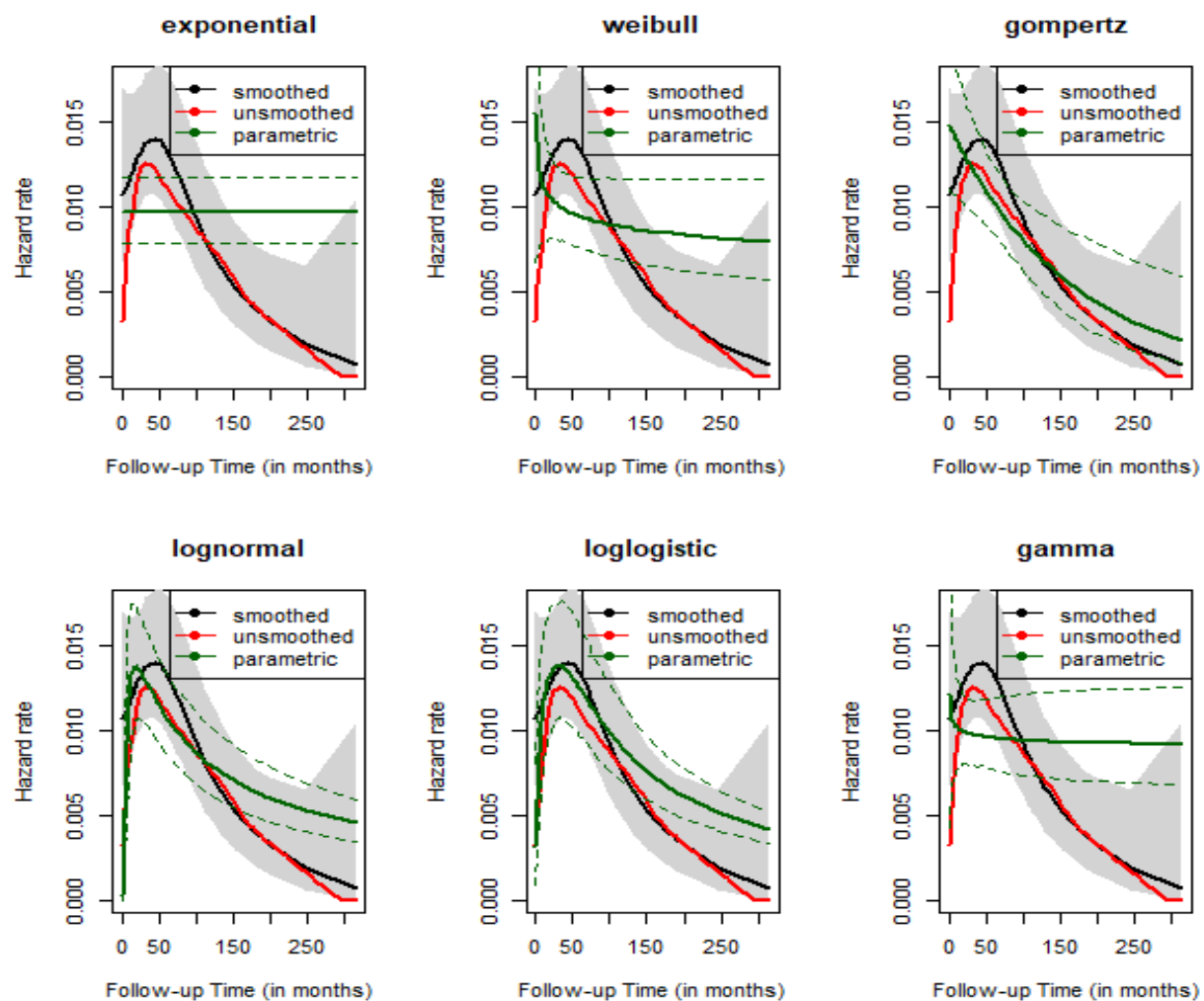

Source: derived from Jakacki 2016 (2).

Company evidence submission template for dabrafenib with trametinib for treating BRAF V600E mutation-positive glioma in children and young people aged 1 to 17 [ID5104]

© Novartis (2023). All rights reserved

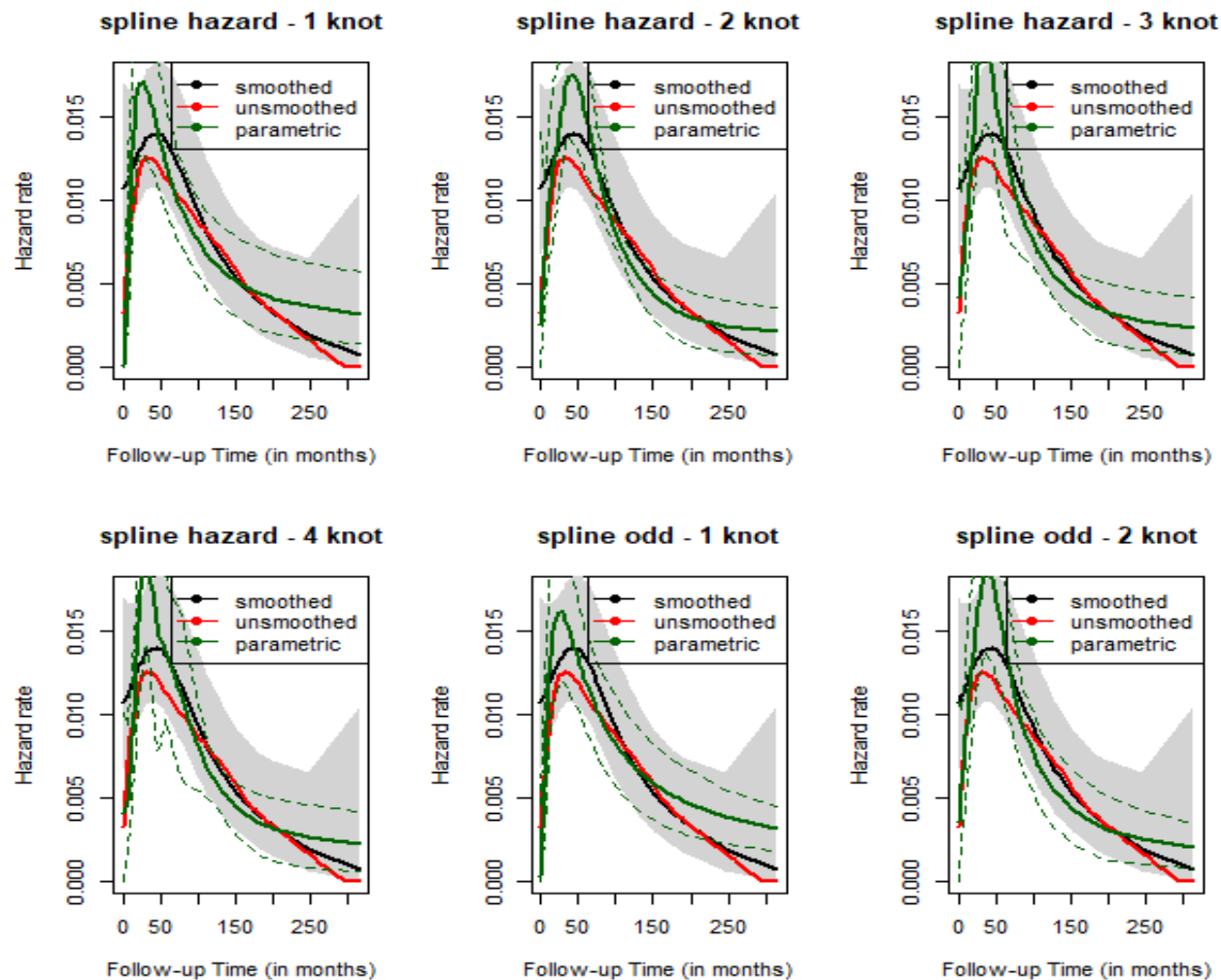

Source: derived from Jakacki 2016 (2).

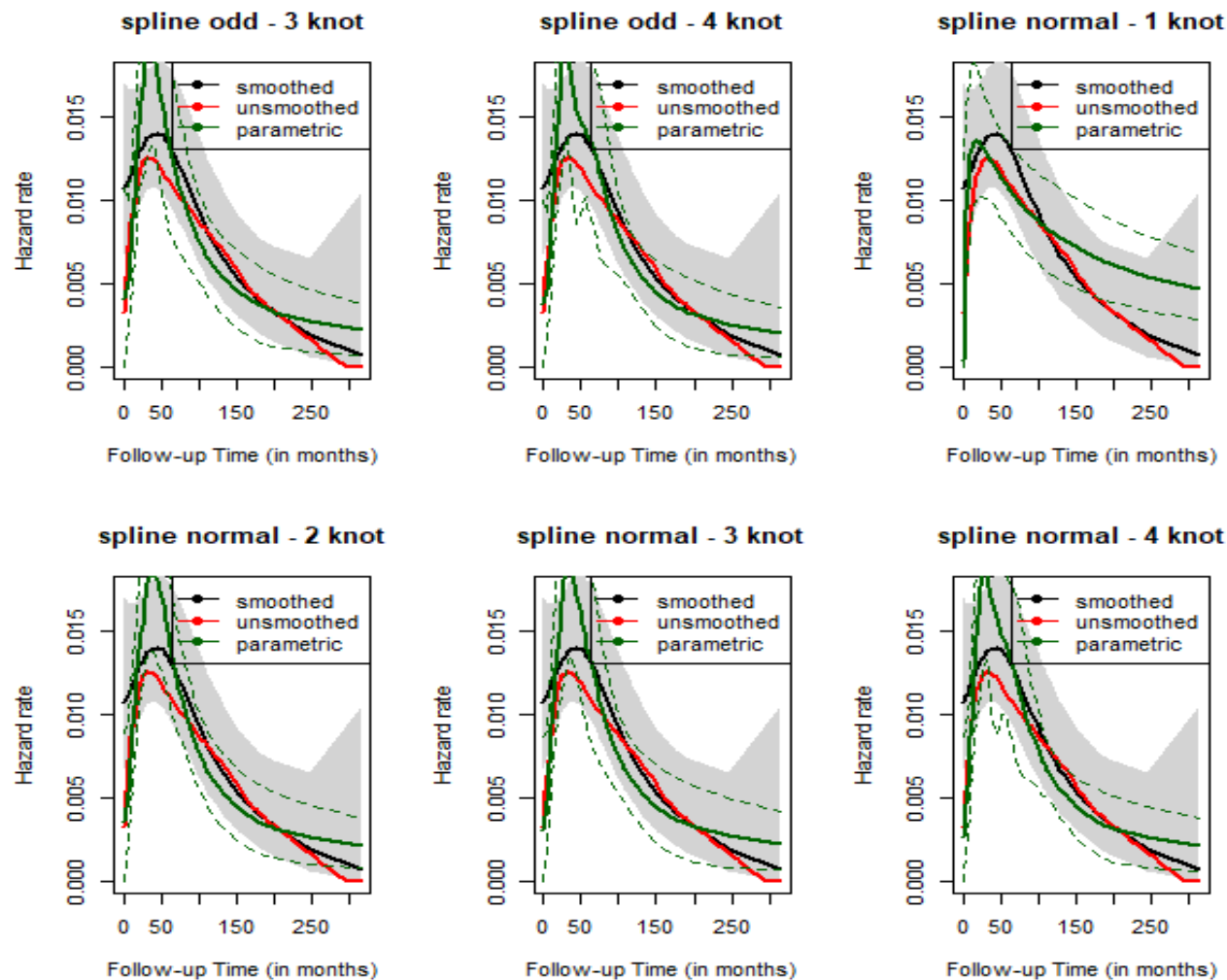

Source: derived from Jakacki 2016 (2).

References

1. Novartis. Clinical study report - Final analysis - April 2023. Phase II open-label global study to evaluate the effect of dabrafenib in combination with trametinib in children and adolescent patients with BRAF V600 mutation positive Low Grade Glioma (LGG) or relapsed or refractory High Grade Glioma (HGG). 2023.
2. Jakacki RI, Cohen KJ, Buxton A, Krailo MD, Burger PC, Rosenblum MK, et al. Phase 2 study of concurrent radiotherapy and temozolomide followed by temozolomide and lomustine in the treatment of children with high-grade glioma: a report of the Children's Oncology Group ACNS0423 study. *Neuro Oncol.* 2016;18(10):1442-50.

Single Technology Appraisal

Dabrafenib with trametinib for treating BRAF V600E mutation-positive glioma in children and young people aged 1 to 17 [ID5104]

Patient Organisation Submission

Thank you for agreeing to give us your organisation's views on this technology and its possible use in the NHS.

You can provide a unique perspective on conditions and their treatment that is not typically available from other sources.

To help you give your views, please use this questionnaire with our guide for patient submissions.

You do not have to answer every question – they are prompts to guide you. The text boxes will expand as you type. [Please note that declarations of interests relevant to this topic are compulsory].

Information on completing this submission

- Please do not embed documents (such as a PDF) in a submission because this may lead to the information being mislaid or make the submission unreadable
- We are committed to meeting the requirements of copyright legislation. If you intend to include **journal articles** in your submission you must have copyright clearance for these articles. We can accept journal articles in NICE Docs.
- Your response should not be longer than 10 pages.

About you

1. Your name	[REDACTED]
2. Name of organisation	The Brain Tumour Charity
3. Job title or position	[REDACTED]
4a. Brief description of the organisation (including who funds it). How many members does it have?	<p>The Brain Tumour Charity is the world’s leading brain tumour charity and the largest dedicated funder of research into brain tumours globally.</p> <p>Committed to saving and improving lives, we’re moving further, faster to help every single person affected by a brain tumour. We’re set on finding new treatments, offering the highest level of support and driving urgent change. And we’re doing it right now. Because we understand that when you, or someone you love, is diagnosed with a brain tumour – a cure really can’t wait.</p> <p>80p in every £1 raised is invested in our charitable objectives – funding research, providing information and support and raising awareness.</p> <p>Our funding comes through a diverse portfolio of income streams, with no reliance on any one stream. This provides greater security in funding multi-year research commitments.</p>
4b. Has the organisation received any funding from the company bringing the treatment to NICE for evaluation or any of the comparator treatment companies in the last 12 months? [Relevant companies are listed in the appraisal stakeholder list.]	<p>We have received no funding from either the funding company or any of the comparator companies in the last 12 months.</p> <p>We have had a consultancy agreement with Advanced Accelerator Applications (AAA), who are now a Novartis company for the following services:</p> <p><i>Provide ongoing consulting on the GLIOBLASTOMA patient perspective as it relates to the development of patient education and support programs and materials.</i></p>

<p>If so, please state the name of the company, amount, and purpose of funding.</p>	<p><i>Provide ongoing consulting on the GLIOBLASTOMA patient perspective as it relates to clinical development activities such as but not limited to: informed consent, patient consent, patient materials for trials, and other issues which may arise which would benefit from a patient's perspective.</i></p> <p>Please note that the consultancy was not provided last year and therefore not invoiced for or paid. We are likely to have a similar agreement in place for the coming year too.</p>
<p>4c. Do you have any direct or indirect links with, or funding from, the tobacco industry?</p>	<p>We do not have any direct or indirect links to the tobacco industry.</p>
<p>5. How did you gather information about the experiences of patients and carers to include in your submission?</p>	<p>The Improving Brain Tumour Care surveys have been designed for patients and their families to identify excellence and gaps in their experience. In 2023, 5 dedicated paediatric surveys were designed and promoted by The Brain Tumour Charity with support from healthcare professionals and those with lived experience. The surveys have been designed to ask different questions dependent on where the patient is on the treatment pathway (diagnosis, surgery, radiotherapy/chemotherapy, living with and palliative care) and is linked to the patients treating hospital so we can track difference in care across the UK.</p> <p>The online surveys were live from June 2023 until August 2023 and promotion took place via social media, email communications and by participating children hospitals across the UK. We received 251 responses from parents whose child was diagnosed or treatment within the past two years, which is what we considered to be a reasonable timeframe to give an up to date portrayal of the current patient experience.</p> <p>For the questions in relation to the advantages and disadvantages of the technology, we engaged with a parent who has a son who is currently receiving the treatment and she posted asking for feedback in two facebook groups for:</p> <ul style="list-style-type: none"> • BRAF driven brain tumour patients (adults and children) but answers have only been put forward from parents of children who are the patients. • Brain tumour patients who are taking "inhibitors" but answers have only been submitted by parents of children who are currently taking Dabrafenib inhibitors per the application. <p>The comments in this section are drawn from those responses to them.</p>

Living with the condition

<p>6. What is it like to live with the condition? What do carers experience when caring for someone with the condition?</p>	<p>Receiving a childhood brain tumour diagnosis is incredibly traumatic for everyone involved from the patient, their parents and siblings. Going through active treatment also impacts on all aspects of a child's life from delays to education, restricted socialising and lasting emotional impact. 59% of respondents reported that they needed more help coping emotionally and 41% needed more help accessing the right treatment and support for their child. On top of this, our community report a poor route to diagnosis with 74% having to visit their GP 3 or more times before receiving a diagnosis.</p> <p>“ [REDACTED] ”</p> <p>When receiving medical treatment, many parents report that the practical and financial burden of travelling to hospital caused strain for the whole family.⁶</p> <p>“ [REDACTED] ”</p> <p>“ [REDACTED] ”</p> <p>Although our often community report great medical treatment for their child's brain tumour, 74% reported that they did not always understand what was happening with their child's treatment and care. In addition, following treatment and discharge they report that they are left alone to deal with the emotional impact and side effects of their child's tumour.</p> <p>“ [REDACTED] ”</p> <p>“ [REDACTED] ”</p> <p>“ [REDACTED] ”</p> <p>“ [REDACTED] ”</p>
--	---

Current treatment of the condition in the NHS

<p>7. What do patients or carers think of current treatments and care available on the NHS?</p>	<p>35% reported that they needed more help exploring other options for their treatment which was outside the standard of NHS care. In addition, 11% have used alternative treatments alongside or instead of the standard of care prescribed by clinicians.</p> <p>“ [REDACTED] ”</p> <p>“ [REDACTED] ”</p>
<p>8. Is there an unmet need for patients with this condition?</p>	<p>We believe that there is a clear unmet need for this patient population.</p> <p>More broadly, in an interview with the American Journal of Managed Care in May 2023 there was an interview with the CEO of Day One Biopharmaceuticals, Jeremy Bender, PhD MBA where he states:</p> <p>“ [REDACTED] ”</p>

Advantages of the technology

9. What do patients or carers think are the advantages of the technology?	Quality of life is returned through this treatment including access to education, with no side effects. A return of confidence for the patient, including being able to spend more time playing with their siblings. Able to participate in lots of recreational activities. Easy to take and fits in well with family life, feels like they are not on treatment.
--	---

Disadvantages of the technology

10. What do patients or carers think are the disadvantages of the technology?	It is not available as a first line treatment, and it should be offered ahead of radiotherapy. One commented that there were no disadvantages at all.
--	--

Patient population

11. Are there any groups of patients who might benefit more or less from the technology than others? If so, please describe them and explain why.	We have no further comment.
--	-----------------------------

Equality

12. Are there any potential equality issues that should be taken into account when considering this condition and the technology?	We have no further comment.
--	-----------------------------

Other issues

13. Are there any other issues that you would like the committee to consider?	<p>Time is another thing to consider as even though both the comparator chemotherapies are given over a relatively short period of time the patient can still be in hospital for most of the day by the time they are admitted, reviewed by a doctor, the chemotherapy is made and delivered from aseptic unit.</p> <p>Getting the IV antiemetics prescribed and given could take over half an hour.</p> <p>You then have patient travel time to their unit and if they are from far away may have to stay. You've then got the time it can take to get their IV access to work.</p> <p>Another consideration more for young children is whether dabrafenib, trametinib can be administered via NG tube or dissolved as getting small children to take tablets is a challenge and crushing chemotherapy/cytotoxic tablets is not ideal for either nursing staff or parents/carers at home.</p>
--	--

Key messages

14. In up to 5 bullet points, please summarise the key messages of your submission.	<ul style="list-style-type: none">• Receiving a brain tumour diagnosis is devastating for the whole family.• There is a clear unmet need for this condition.• 35% reported that they needed more help exploring other options for their treatment which was outside the standard of NHS care.• 11% have used alternative treatments alongside or instead of the standard of care prescribed by clinicians• The convenience of the treatment is significant.
--	---

Thank you for your time.

Please log in to your NICE Docs account to upload your completed submission.

Your privacy

The information that you provide on this form will be used to contact you about the topic above.

Please select YES if you would like to receive information about other NICE topics – YES

For more information about how we process your personal data please see our [privacy notice](#).

Single Technology Appraisal

Dabrafenib with trametinib for treating BRAF V600E mutation-positive glioma in children and young people aged 1 to 17 [ID5104]

Clinical expert statement

Information on completing this form

In [part 1](#) we are asking for your views on this technology. The text boxes will expand as you type.

In [part 2](#) we are asking you to provide 5 summary sentences on the main points contained in this document.

Please do not embed documents (such as a PDF) in a submission because this may lead to the information being mislaid or make the submission unreadable. Please type information directly into the form.

Do not include medical information about yourself or another person that could identify you or the other person.

We are committed to meeting the requirements of copyright legislation. If you want to include **journal articles** in your submission you must have copyright clearance for these articles. We can accept journal articles in NICE Docs. For copyright reasons, we will have to return forms that have attachments without reading them. You can resubmit your form without attachments, but it must be sent by the deadline.

Combine all comments from your organisation (if applicable) into 1 response. We cannot accept more than 1 set of comments from each organisation.

Clinical expert statement

Dabrafenib with trametinib for treating BRAF V600E mutation-positive glioma in children and young people aged 1 to 17 [ID5104]

Please underline all confidential information, and separately highlight information that is submitted as 'confidential [CON]' in turquoise, and all information submitted as 'depersonalised data [DPD]' in pink. If confidential information is submitted, please also send a second version of your comments with that information redacted. See [Health technology evaluations: interim methods and process guide for the proportionate approach to technology appraisals](#) (section 3.2) for more information.

The deadline for your response is **5pm on 20 February 2024**. Please log in to your NICE Docs account to upload your completed form, as a Word document (not a PDF).

Thank you for your time.

We reserve the right to summarise and edit comments received, or not to publish them at all, if we consider the comments are too long, or publication would be unlawful or otherwise inappropriate.

Comments received are published in the interests of openness and transparency, and to promote understanding of how recommendations are developed. The comments are published as a record of the comments we received, and are not endorsed by NICE, its officers or advisory committees.

Clinical expert statement

Dabrafenib with trametinib for treating BRAF V600E mutation-positive glioma in children and young people aged 1 to 17 [ID5104]

Part 1: Treating BRAF V600E mutation-positive glioma in children and young people aged 1 to 17 and current treatment options

Table 1 About you, aim of treatment, place and use of technology, sources of evidence and equality

1. Your name	Professor John-Paul Kilday
2. Name of organisation	Children's Cancer & Leukaemia Group (CCLG)
3. Job title or position	Paediatric Neuro-oncology Consultant and Honorary MAHSC (Manchester Academic Health Science Centre) Chair in Paediatric Oncology Chair of the CCLG's Neuro-oncology Specialist Interest Group
4. Are you (please tick all that apply)	<input checked="" type="checkbox"/> An employee or representative of a healthcare professional organisation that represents clinicians? <input checked="" type="checkbox"/> A specialist in the treatment of children and young people with glioma? <input checked="" type="checkbox"/> A specialist in the clinical evidence base for glioma or dabrafenib and trametinib? <input type="checkbox"/> Other (please specify):
5. Do you wish to agree with your nominating organisation's submission? (We would encourage you to complete this form even if you agree with your nominating organisation's submission)	<input checked="" type="checkbox"/> Yes, I agree with it <input type="checkbox"/> No, I disagree with it <input type="checkbox"/> I agree with some of it, but disagree with some of it <input type="checkbox"/> Other (they did not submit one, I do not know if they submitted one etc.)
6. If you wrote the organisation submission and/or do not have anything to add, tick here. (If you tick this box, the rest of this form will be deleted after submission)	<input type="checkbox"/> Yes

Clinical expert statement

Dabrafenib with trametinib for treating BRAF V600E mutation-positive glioma in children and young people aged 1 to 17 [ID5104]

<p>7. Please disclose any past or current, direct or indirect links to, or funding from, the tobacco industry.</p>	<p>Nothing to disclose</p>
<p>8. What is the main aim of treatment for BRAF V600E mutation-positive glioma in children and young people aged 1 to 17? (For example, to stop progression, to improve mobility, to cure the condition, or prevent progression or disability)</p>	<p>For patients with new or progressive <i>BRAF V600E</i> mutation-positive low-grade glioma (LGG) who require systemic therapy (within this age bracket), the aims of treatment are multiple:</p> <ul style="list-style-type: none"> a) to stop subsequent tumour progression (including to abrogate malignant transformation of the lesion). b) to achieve tumour response (reduction in lesion size) to therapy including curative intent that is sustained. c) to enable sustained clinical benefit from usage with an improved quality of life and avoidance of new or worsening disability for impacted patients. d) to represent an improvement in efficacy from current standard of care therapy without compromising safety for this patient cohort. <p>Similarly, for patients with <i>BRAF V600E</i> mutation-positive high-grade glioma (HGG) (within this age bracket), the aims of treatment are again multiple:</p> <ul style="list-style-type: none"> a) to stop subsequent tumour progression. b) to achieve tumour response (reduction in lesion size) to therapy including possible curative intent that is sustained. c) to enable sustained clinical benefit from usage with an improved quality of life and avoidance of new or worsening disability for impacted patients. d) to represent an improvement in efficacy from current standard of care therapy without compromising safety for this patient cohort.
<p>9. What do you consider a clinically significant treatment response? (For example, a reduction in tumour size by x cm, or a reduction in disease activity by a certain amount)</p>	<p>Tumour response can be evaluated in different ways depending on the site and disability induced by the lesion:</p> <ol style="list-style-type: none"> 1. Radiologically: Overall tumour response (radiologically as defined by 2017 RANO criteria (Response Assessment in Neuro-oncology Clinical Trials) which is defined as the best overall complete (disappearance of target

Clinical expert statement

Dabrafenib with trametinib for treating BRAF V600E mutation-positive glioma in children and young people aged 1 to 17 [ID5104]

	<p>lesion) or partial response (greater than or equal to a 50% reduction in the product of the longest perpendicular tumour diameters) compared to baseline imaging.</p> <ol style="list-style-type: none"> 2. A response as defined radiologically as per (1) but that needs to be sustained for a minimum of greater than or equal to 6 months from initiation of therapy. 3. Overall, the patient should be clinically stable or have improved on physical examination and functional, neurological and quality of life assessments. <p>References:</p> <ul style="list-style-type: none"> • Response Assessment in Neuro-Oncology Clinical Trials. Wen PY, Chang SM, Van den Bent MJ, Vogelbaum MA, Macdonald DR, Lee EQ. J Clin Oncol. 2017 Jul 20;35(21):2439-2449. doi: 10.1200/JCO.2017.72.7511. Epub 2017 Jun 22.
<p>10. In your view, is there an unmet need for patients and healthcare professionals in BRAF V600E mutation-positive glioma in children and young people aged 1 to 17?</p>	<p>There is an unmet need for patients with <i>BRAF V600E</i> low-grade and high-grade glioma.</p> <p><i>Patients with BRAF V600E mutation-positive low-grade glioma:</i> Published evidence (Lassaletta et al, 2017, Ryall et al, 2020, Bouffet et al, 2023) shows that such patients have sub-optimal responses to conventional chemotherapeutic and radiotherapeutic approaches, with a consequent inferior progression-free and overall survival, often multiple disease relapse episodes and a cumulative toxicity burden when compared with most other low-grade glioma patient groups. Such repeated admissions and attendances to hospital have physical and emotional health & wellbeing implications for the patient and their family, alongside the social and financial burdens that ensue. This is mirrored by the significant, repeated resource allocation for health care professionals (bed occupancy, chemotherapy use, supportive care implications, staffing resource etc).</p> <p><i>Patients with BRAF V600E mutation-positive high-grade glioma:</i> Despite decades of attempting to improve therapeutic options for paediatric high-grade glioma patients, overall response rates (as defined by RANO criteria above)</p>

Clinical expert statement

Dabrafenib with trametinib for treating BRAF V600E mutation-positive glioma in children and young people aged 1 to 17 [ID5104]

	<p>are less than 20%, with less than one fifth of children alive at 2 years. At relapse, the response rates are less than or equal to 12% or below from limited studies. There is no recognised standard of care for paediatric, relapsed high-grade glioma (Hargrave et al, 2023).</p> <p>For both groups, this unmet need also pertains to infants with <i>BRAF V600E</i> mutated lesions aged below 1 year (albeit rarely), and to young adults aged above 17 years that would be excluded – this warrants consideration.</p> <p>References:</p> <ul style="list-style-type: none"> • Therapeutic and Prognostic Implications of BRAF V600E in Pediatric Low-Grade Gliomas. Lassaletta A et al. J Clin Oncol. 2017 Sep 1;35(25):2934-2941. doi: 10.1200/JCO.2016.71.8726. • Integrated Molecular and Clinical Analysis of 1,000 Pediatric Low-Grade Gliomas. Ryall S et al. Cancer Cell. 2020 Apr 13;37(4):569-583.e5. doi: 10.1016/j.ccell.2020.03.011. • Dabrafenib plus Trametinib in Pediatric Glioma with BRAF V600 Mutations. Bouffet E et al. N Engl J Med. 2023 Sep 21;389(12):1108-1120. doi: 10.1056/NEJMoa2303815. • Phase II Trial of Dabrafenib Plus Trametinib in Relapsed/Refractory BRAF V600-Mutant Pediatric High-Grade Glioma. Hargrave DR et al. J Clin Oncol. 2023 Nov 20;41(33):5174-5183. doi: 10.1200/JCO.23.00558.
<p>11. How is BRAF V600E mutation-positive glioma in children and young people aged 1 to 17 currently treated in the NHS?</p> <ul style="list-style-type: none"> • Are any clinical guidelines used in the treatment of the condition, and if so, which? • Is the pathway of care well defined? Does it vary or are there differences of opinion between professionals across the NHS? (Please state if your experience is from outside England.) 	<p>Currently, children and young adults with newly diagnosed and progressive LGG and HGG (incorporating <i>BRAF V600E</i> mutated gliomas) are treated according to national guidance documents, issued by the CCLG, to enable standardised pathways of care. They are as below:</p> <ul style="list-style-type: none"> • <i>Guidelines for the diagnosis and management of paediatric and adolescent Low-Grade Glioma (Picton et al, 2020)</i>. This includes a first to fourth-line order for conventional therapy of unresectable, progressive paediatric low-grade glioma. • <i>CCLG Brain Tumour Group High-Grade Glioma Guidelines (Wilkins et al, 2007)</i>

Clinical expert statement

Dabrafenib with trametinib for treating BRAF V600E mutation-positive glioma in children and young people aged 1 to 17 [ID5104]

<ul style="list-style-type: none"> • What impact would the technology have on the current pathway of care? 	<p>However, given the recent changing national landscape for acquisition of biological targeted therapy in paediatric LGG and HGG, the CCLG subsequently created a National MAPK glioma group that created a UK priority list for MAPK inhibitors (Kilday / Hargrave et al, 2023), including a bespoke segment for patients with <i>BRAF V600E</i> mutation positive gliomas. It accounts for the impact of dabrafenib and trametinib on the current pathway of care, and states the following:</p> <ul style="list-style-type: none"> • For newly diagnosed <i>BRAF V600E</i> mutated LGGs - follow standard of care as per CCLG LGG guidelines or clinical trial (if available). • Dabrafenib and trametinib can be administered as 3rd line or later therapy for progressive/recurrent <i>BRAF V600E</i> mutated LGG, following discussion with the national MAPK glioma group. Only to be considered for progression after 2nd line of systemic chemotherapy as per UK CCLG low-grade glioma guidance and patient must have risk of severe/significant neurological decline/death. Estimated 10 extra patients per year eligible for such 3rd line therapy (will be reviewed if 10 reached in a year) • For newly diagnosed <i>BRAF V600E</i> mutated HGGs - follow standard of care as per CCLG HGG guidelines or clinical trial (if available). • Dabrafenib and trametinib can be administered as 2nd line or later therapy for progressive/recurrent <i>BRAF V600E</i> mutated HGG, following discussion with the national MAPK glioma group. Only to be considered for progression after 1st line standard of care systemic therapy and patient must have risk of severe/significant neurological decline/death. Estimated 4 - 8 extra patients per year eligible for 2nd line therapy (will be reviewed if 8 reached in a year) <p>References:</p> <ul style="list-style-type: none"> • Guidelines for the diagnosis and management of paediatric and adolescent Low Grade Glioma Picton et al. Version 1, January 2020, Available on CCLG website to members. • CCLG Brain Tumour Group High Grade Glioma Guidelines Wilkins et al. Version 2.0 22nd November 2007, Available on CCLG website to members.
---	---

Clinical expert statement

Dabrafenib with trametinib for treating *BRAF V600E* mutation-positive glioma in children and young people aged 1 to 17 [ID5104]

<p>12. Will the technology be used (or is it already used) in the same way as current care in NHS clinical practice?</p> <ul style="list-style-type: none"> • How does healthcare resource use differ between the technology and current care? • In what clinical setting should the technology be used? (for example, primary or secondary care, specialist clinic) • What investment is needed to introduce the technology? (for example, for facilities, equipment, or training) 	<p>This answer is dependent on the clinical context and if the patient has a <i>BRAF V600E</i> mutation-positive, unresectable LGG or <i>BRAF V600E</i> mutation-positive HGG.</p> <p>Patients receiving dabrafenib and trametinib for a <i>BRAF V600E</i> mutated glioma should be treated and monitored in the outpatient setting of a Tertiary Specialist (CCLG accredited) Principal Treatment Centre for Paediatric Haematology / Oncology. This too remains the case for current <i>BRAF V600E</i> mutation-positive LGG or HGG patients treated upfront with conventional chemotherapy (and to a lesser extent radiotherapy as this is often administered in co-located institutions, and may require inpatient admission to deliver depending on context). At HGG relapse, no recognised standard of care therapy exists.</p> <p>The frequency of attendance to such outpatient clinics is likely to reduce over time if the patient receiving the inhibitor combination remains clinically and radiologically stable, which will reduce healthcare resource burden compared to current care packages (reductions in inpatient stays from treatment administration and adverse or supportive care events, reduced need for pharmacy aseptic team involvement to generate chemotherapy, reductions in supportive care adjunct medication such as anti-emetic medication, antibiotic prophylaxis, reduction in nutritional support interventions etc).</p> <p>There should not be a requirement for significant investment to introduce the technology when compared against the current investment of manufacturing, delivering, and managing the sequelae of conventional therapeutics. Patients will require regular clinical, blood and imaging evaluations across both therapeutic strategies (current practice versus proposed technology) and modifications to surveillance and supportive care (e.g. cardiac (ECHO, ECG, blood pressure), dermatological management and ophthalmic surveillance) would be offset against savings from the aforementioned reduction in healthcare resource burden.</p>
---	---

Clinical expert statement

Dabrafenib with trametinib for treating *BRAF V600E* mutation-positive glioma in children and young people aged 1 to 17 [ID5104]

<p>13. Do you expect the technology to provide clinically meaningful benefits compared with current care?</p> <ul style="list-style-type: none"> • Do you expect the technology to increase length of life more than current care? • Do you expect the technology to increase health-related quality of life more than current care? 	<p>Yes, I expect dabrafenib & trametinib to provide clinically meaningful benefits compared with current care for children and young adults with <i>BRAF V600E</i> mutation-positive gliomas.</p> <p>A dose-finding and cohort expansion Phase I/II study to Investigate Safety, Pharmacokinetic (PK), Pharmacodynamic (PD) and Clinical Activity of Trametinib in Subjects With Cancer or Plexiform Neurofibromas and Trametinib in Combination With Dabrafenib in Subjects With Cancers Harbouring V600 Mutations (ClinicalTrials.gov ID NCT02124772), reported improved overall response rates with the combination compared to trametinib monotherapy (25% versus 15%), while adverse events resulting in discontinuation of therapy were more common with trametinib monotherapy compared with the combination (Bouffet et al 2023, JCO).</p> <p>For <i>BRAF V600E</i> mutation-positive LGG patients, a recent randomised, open-label Phase II trial (ClinicalTrials.gov ID NCT02684058) comparing the technology at diagnosis against the globally accepted standard first-line therapy (vincristine / carboplatin (VC)) reported an overall response rate of 47% for the technology versus 11% for VC. Protracted clinical benefit was higher (86% versus 46%), median progression-free survival was longer (20.1 months versus 7.4 months) and significant organ toxicity was lower (47% versus 94%) for dabrafenib with trametinib compared to conventional chemotherapy. Patient reported outcome measures across all domains other than pain (equivocal) also favoured the inhibitor combination (Bouffet et al, 2023).</p> <p>For <i>BRAF V600E</i> mutation-positive relapsed / refractory HGG patients, the same Phase II trial (ClinicalTrials.gov ID NCT02684058) encapsulated 41 paediatric patients treated with dabrafenib with trametinib and revealed that at 25 months median follow-up, over half of the cohort remained on therapy. Overall response rates were 56% with a median duration of response of 22 months and a median</p>
---	---

Clinical expert statement

Dabrafenib with trametinib for treating *BRAF V600E* mutation-positive glioma in children and young people aged 1 to 17 [ID5104]

overall survival of 33 months (Hargrave et al, 2023). This is in comparison to conventional therapy for relapsed / refractory HGG from meta-analysis where response rates are below 12% and median survival of 5.6 months (Kline et al, 2018).

It is noted that the U.S. FDA have already approved these agents in 2 paediatric indications:

- *BRAF V600E* Mutation-Positive Low-Grade Glioma dabrafenib is indicated, in combination with trametinib, for the treatment of paediatric patients 1 year of age and older with low-grade glioma (LGG) with a *BRAF V600E* mutation who require systemic therapy 16 March 2023
- Accelerated approval to dabrafenib in combination with trametinib for the treatment of adult and paediatric patients ≥ 6 years of age with unresectable or metastatic solid tumours with *BRAF V600E* mutation who have progressed following prior treatment and have no satisfactory alternative treatment options. June 22, 2022.

References:

- Efficacy and Safety of Trametinib Monotherapy or in Combination With Dabrafenib in Pediatric BRAF V600-Mutant Low-Grade Glioma
Bouffet et al. J Clin Oncol. 2023 Jan 20;41(3):664-674. doi: 10.1200/JCO.22.01000.
- Dabrafenib plus Trametinib in Pediatric Glioma with BRAF V600 Mutations.
Bouffet E et al. N Engl J Med. 2023 Sep 21;389(12):1108-1120. doi: 10.1056/NEJMoa2303815.
- Phase II Trial of Dabrafenib Plus Trametinib in Relapsed/Refractory BRAF V600-Mutant Pediatric High-Grade Glioma.
Hargrave DR et al. J Clin Oncol. 2023 Nov 20;41(33):5174-5183. doi: 10.1200/JCO.23.00558.
- Survival outcomes in pediatric recurrent high-grade glioma: Results of a 20-year systematic review and meta-analysis.
Kline C et al. J Neurooncol 137:103-110, 2018

Clinical expert statement

Dabrafenib with trametinib for treating BRAF V600E mutation-positive glioma in children and young people aged 1 to 17 [ID5104]

<p>14. Are there any groups of people for whom the technology would be more or less effective (or appropriate) than the general population?</p>	<p>Clearly dabrafenib and trametinib would only be considered for patients with tissue-proven <i>BRAF V600E</i> mutation-positive gliomas as opposed to the general population, including glioma patients that do not demonstrate this MAPK molecular alteration. Of note, there are other paediatric <i>BRAF V600E</i> mutation-positive indications such as Langerhans Cell Histiocytosis (LCH) and other solid tumours that the FDA has reviewed for perceived benefit.</p> <p>There is no suggestion that certain members of the general population with <i>BRAF V600E</i> mutated gliomas would fare better or worse on the inhibitor combination compared to others, except patients that met the exclusion criteria for the Phase II trial(s) pertaining to the technology, for instance (not exhaustive):</p> <ul style="list-style-type: none"> a) Patients with alternative <i>BRAF</i> mutations or <i>RAS</i> mutations in the lesion. b) Patients still within the washout periods of preceding treatments. c) Patients with active cardiac disease that could pose a safety risk. d) Patients with unresolved toxicities from previous therapy. e) Patients with history of allergy to compounds similar to the technology or their excipients. f) Patients with factors that may interfere with administration and monitoring compliance. g) Patients with active gastrointestinal disease that could pose a safety risk. h) Women of child-bearing potential (unless using highly effective means of contraception for duration of technology therapy and for 16 weeks following discontinuation of such therapy). i) Sexually active males (unless using highly effective means of contraception for duration of technology therapy and for 16 weeks following discontinuation of such therapy). j) Patients with a history of Hepatitis B or C infection. k) Patients on additional concomitant medication that could interfere with drug efficacy, such as other anti-cancer therapies, anti-retroviral medication, herbal remedies (e.g. St. John's wort), warfarin, and drugs that strongly induce or inhibit cytochrome enzyme (CYP2C8, and CYP3A) activity. l) Breastfeeding females m) Patients with a history of retinal vein occlusion or serous retinopathy
<p>15. Will the technology be easier or more difficult to use for patients or healthcare professionals than</p>	<p>It is anticipated that dabrafenib and trametinib in combination would be generally more acceptable to patients, families and healthcare professionals than current therapeutic modalities.</p>

Clinical expert statement

Dabrafenib with trametinib for treating *BRAF V600E* mutation-positive glioma in children and young people aged 1 to 17 [ID5104]

<p>current care? Are there any practical implications for its use?</p> <p>(For example, any concomitant treatments needed, additional clinical requirements, factors affecting patient acceptability or ease of use or additional tests or monitoring needed)</p>	<p>The inhibitor combination is administered orally, rather than conventional first-line chemotherapy for paediatric LGGs which involves intravenous administration and the need for central venous access insertion and access (which can be a source of pain and anxiety for the patient). The risk of significant myelosuppression and sepsis with the novel technology is lower compared with standard of care chemotherapy for LGGs. The technology can be administered by the patient or parent at home, abrogating the need for and frequency of hospital admission (both outpatient and inpatient following complications). Supportive care focus is different between treatment strategies, with fewer patients requiring anti-emetic medication and nutritional support interventions on the inhibitor combination compared with systemic chemotherapy; the focus being more on prevention of dermatological complications with topical preparations, monitoring weight gain and vital signs, monitoring for hepatic, renal and cardiac impairment, and prevention of diarrhoea. Many of the investigations and monitoring that would be undertaken when using dabrafenib with trametinib are already used with current therapy for <i>BRAF V600E</i> mutated LGG and HGG (e.g. clinical evaluation with vital sign analysis, neuro-imaging, bloodwork evaluation of bone marrow, hepatic and renal function). Additional monitoring that would not occur with current conventional therapy includes:</p> <ul style="list-style-type: none"> • Dermatological assessments for adverse effects relating to the technology • Regular cardiac investigative surveillance (echocardiography and ECG monitoring) • Bloodwork assessment of long-term glucose control and creatine kinase enzyme release (in addition to those performed with current conventional therapies) • Regular ophthalmological surveillance for ocular toxicity from inhibitor therapy (occurs currently if patient has LGG of optic pathway) • X-rays of left wrist and tibia if growth plates not closed. <p>The above can be embedded into outpatient clinic visits or can be added to tests performed as standard of care and are not considered significant interventions</p>
--	---

Clinical expert statement

Dabrafenib with trametinib for treating BRAF V600E mutation-positive glioma in children and young people aged 1 to 17 [ID5104]

	<p>that would cause undue distress to the patient. The uplift in cardiac investigative time is noted.</p> <p>There may be value to reviewing paediatric dabrafenib formulations to allow easier administration in patients either too young to reliably swallow tablets or unable due to neurological disability. Dabrafenib is currently available in dispersible tablets. Trametinib is available as a paediatric suspension. In addition, a review of pharmacological stability if administered by nasogastric or gastrostomy tube would be of benefit if not known already.</p> <p>The time required to remain on the technology to realise optimum efficacy has not been realised, such that protracted clinic visits and monitoring investigations may be required spanning several years and perhaps indefinitely. In addition, late effects of such inhibitor combination therapy remain elusive such that further monitoring may be introduced with time if a late adverse event is identified in future analyses.</p>
<p>16. Will any rules (informal or formal) be used to start or stop treatment with the technology? Do these include any additional testing?</p>	<p>Patient inclusion and exclusion criteria for the initiation of the technology should mirror those set in the Phase II trial(s) for paediatric and young adult patients with <i>BRAF V600E</i> mutation-positive LGG and HGGs (Bouffet et al, 2023NEJM, Hargrave et al, 2023, Bouffet et al, JCO). These would not include additional testing to that already performed as standard of care.</p> <p>Stopping rules in the face of toxicity for the technology should also mirror those set in the Phase II trial(s) for paediatric and young adult patients with <i>BRAF V600E</i> mutation-positive LGG and HGGs (Bouffet et al, 20203, Hargrave et al, 2023). These would not include additional testing to that already performed as routine monitoring whilst on the inhibitor combination.</p> <p>References:</p> <ul style="list-style-type: none"> • Dabrafenib plus Trametinib in Pediatric Glioma with BRAF V600 Mutations. Bouffet E at I. N Engl J Med. 2023 Sep 21;389(12):1108-1120. doi:

Clinical expert statement

Dabrafenib with trametinib for treating BRAF V600E mutation-positive glioma in children and young people aged 1 to 17 [ID5104]

	<p>10.1056/NEJMoa2303815.</p> <ul style="list-style-type: none"> Phase II Trial of Dabrafenib Plus Trametinib in Relapsed/Refractory BRAF V600-Mutant Pediatric High-Grade Glioma. Hargrave DR et al. J Clin Oncol. 2023 Nov 20;41(33):5174-5183. doi: 10.1200/JCO.23.00558 Efficacy and Safety of Trametinib Monotherapy or in Combination With Dabrafenib in Pediatric BRAF V600-Mutant Low-Grade Glioma Bouffet et al. J Clin Oncol. 2023 Jan 20;41(3):664-674. doi: 10.1200/JCO.22.01000.
<p>17. Do you consider that the use of the technology will result in any substantial health-related benefits that are unlikely to be included in the quality-adjusted life year (QALY) calculation?</p> <ul style="list-style-type: none"> Do the instruments that measure quality of life fully capture all the benefits of the technology or have some been missed? For example, the treatment regimen may be more easily administered (such as an oral tablet or home treatment) than current standard of care 	<p>As stated above, dabrafenib and trametinib are oral preparations that can be dispensed to the patient for home administration. This, together with the modified side-effect profile of the inhibitor combination compared to conventional therapy for <i>BRAF V600E</i> mutated LGGs (primary or progressive) and relapsed / refractory <i>BRAF V600E</i> HGGs, means that frequency of attendance to hospital is likely to reduce over time if the patient receiving the inhibitor combination remains clinically and radiologically stable. This will preserve patient emotional health and wellbeing due to care being performed at home with some degree of autonomy as children often find hospital visits anxiety-inducing, particularly if associated with repetitive intravenous access. It also has the likelihood of reducing inpatient bed occupancy given the reduction in associated supportive care needs (e.g. febrile neutropenia, significant nausea and vomiting, need for interventional nutritional support) that can be seen with standard of care therapies in place currently. The financial toxicity burden for parents from repeated and protracted hospital visits for their children would also be reduced.</p> <p>There is further work to determine whether the inhibitor combination could also preserve or improve functional outcomes such as visual acuity for patients with <i>BRAF V600E</i> mutated gliomas of the optic pathway.</p>
<p>18. Do you consider the technology to be innovative in its potential to make a significant and substantial impact on health-related benefits and how might it improve the way that current need is met?</p>	<p>The Phase II trial(s) of dabrafenib and trametinib do indeed represent a step-change in the management of children and young adults with <i>BRAF V600E</i> mutated gliomas, providing significant health benefits compared to current therapies available, and therein meeting the unmet needs highlighted in the answer to question 10 as summarised again below:</p>

Clinical expert statement

Dabrafenib with trametinib for treating BRAF V600E mutation-positive glioma in children and young people aged 1 to 17 [ID5104]

- Is the technology a 'step-change' in the management of the condition?
- Does the use of the technology address any particular unmet need of the patient population?

Patients with BRAF V600E mutation-positive low-grade glioma:

As stated, these patients have sub-optimal responses to conventional chemotherapeutic and radiotherapeutic approaches, with a consequent inferior progression-free and overall survival, often multiple disease relapse episodes and a cumulative toxicity burden when compared with most other low-grade glioma patients. Such repeated admissions and attendances to hospital have physical and emotional health / wellbeing implications for the patient and their family, alongside the social and financial burdens that ensue. This is mirrored by the significant, repeated resource allocation for health care professionals (bed occupancy, chemotherapy use, supportive care implications, staffing resource etc).

The Phase II randomised, open-label trial of dabrafenib with trametinib as first-line therapy in *BRAF V600E* mutated low-grade gliomas (ClinicalTrials.gov ID NCT02684058), reported an overall response rate of 47% for the technology versus 11% for standard first-line chemotherapy. Protracted clinical benefit was higher (86% versus 46%), median progression-free survival was longer (20.1 months versus 7.4 months) and significant organ toxicity was lower (47% versus 94%) with dabrafenib/trametinib when compared to conventional chemotherapy (Bouffet et al, 2023). This, together with further evidence from the Phase I/II study assessing trametinib in combination with dabrafenib in children with lesions harbouring *BRAF V600E* mutations (ClinicalTrials.gov ID NCT02124772) (Bouffet et al, 2023 JCO), indicates that dabrafenib with trametinib should be considered for both newly diagnosed and progressive, relapsed paediatric *BRAF V600E* mutated low-grade glioma at any stage of disease, and at any point in a treatment decision pathway.

Patients with BRAF V600E mutation-positive high-grade glioma:

Current overall response rates for these patients with current upfront therapies are less than 20%, with less than one fifth of children alive at 2 years. At relapse, the response rates are less than or equal to 12% or below with a median survival of

Clinical expert statement

Dabrafenib with trametinib for treating BRAF V600E mutation-positive glioma in children and young people aged 1 to 17 [ID5104]

	<p>5.6 months (Kline et al, 2018). There is no recognised standard of care for paediatric, relapsed high-grade glioma.</p> <p>The Phase II trial of dabrafenib with trametinib for <i>BRAF V600E</i> mutation-positive glioma ((ClinicalTrials.gov ID NCT02684058) incorporated 41 high-grade glioma patients and demonstrated that at 25 months median follow-up, over half of the cohort remained on therapy. Overall response rates were 56% with a median duration of response of 22 months and a median overall survival of 33 months (Hargrave et al, 2023).</p> <p>References:</p> <ul style="list-style-type: none"> • Dabrafenib plus Trametinib in Pediatric Glioma with BRAF V600 Mutations. Bouffet E et al. N Engl J Med. 2023 Sep 21;389(12):1108-1120. doi: 10.1056/NEJMoa2303815. • Phase II Trial of Dabrafenib Plus Trametinib in Relapsed/Refractory BRAF V600-Mutant Pediatric High-Grade Glioma. Hargrave DR et al. J Clin Oncol. 2023 Nov 20;41(33):5174-5183. doi: 10.1200/JCO.23.00558. • Efficacy and Safety of Trametinib Monotherapy or in Combination With Dabrafenib in Pediatric BRAF V600-Mutant Low-Grade Glioma. Bouffet et al. J Clin Oncol. 2023 Jan 20;41(3):664-674. doi: 10.1200/JCO.22.01000. • Survival outcomes in pediatric recurrent high-grade glioma: Results of a 20-year systematic review and meta-analysis. Kline C et al. J Neurooncol 137:103-110, 2018
<p>19. How do any side effects or adverse effects of the technology affect the management of the condition and the patient's quality of life?</p>	<p>The impact of adverse effects of dabrafenib with trametinib on the patient's management and quality of life is very individualised: it will depend on the type and grade of the adverse event and the individual's clinical status, particularly as protracted use may need consideration. It is noted that the Phase II trial in paediatric / young adult <i>BRAF V600E</i> mutation-positive LGGs, found much lower rates of high-grade toxicity (Grade 3 or higher) than conventional chemotherapy (47% versus 94%) (Bouffet et al, 2023 NEJM), while the Phase I/II study assessing trametinib in combination with dabrafenib in children with lesions harbouring BRAF V600E mutations (ClinicalTrials.gov ID NCT02124772) (Bouffet et al, 2023 JCO) found an improved safety profile for the combination versus trametinib alone.</p>

Clinical expert statement

Dabrafenib with trametinib for treating BRAF V600E mutation-positive glioma in children and young people aged 1 to 17 [ID5104]

	<p>The most common, lower-grade toxicities reported in the trial(s) (such as pyrexia, headache, musculoskeletal pain, nausea, vomiting, fatigue, dry skin, paronychia, epistaxis) are typically managed at home without hospital admission, sometimes with accompanying supportive care medication (Bouffet et al, 2023 NEJM, Bouffet et al, 2023 JCO, Hargrave et al, 2023)</p> <p>Dermatological side effects, even when low grade, can have a negative impact on a patient's quality of life, for instance due to the cosmetic appearances of acneiform rashes in older children and young adults.</p> <p>Less frequent, but moderately higher-grade toxicities may impact on the ability to manage the sequelae at home and may result in hospital admission (outpatient or rarely inpatient), or technology interruption followed by dose reduction, alongside concomitant supportive care measures. For example, infected paronychia may require drug interruption, topical antiseptic preparations (bleach baths), topical steroid creams, systemic antibiotic therapy etc.</p> <p>Very rare, high-grade toxicities would typically result in therapeutic interruption and, in certain circumstances drug cessation, if felt to be a significant risk to patient health or function or if irreversible in mechanistic action of toxicity. Such stopping rules and modifications are defined in the Phase II Trial documentation (ClinicalTrials.gov ID NCT02684058) in relation to all Grade 3-4 organ toxicities and specifically pyrexia syndrome, renal insufficiency, ocular toxicities, cardiac toxicity, pneumonitis, suspected skin malignancies, glucose control, dermatological toxicity, hypertension and clotting derangements (Bouffet et al, 2023, Hargrave et al, 2023).</p> <p>References:</p> <ul style="list-style-type: none">• Dabrafenib plus Trametinib in Pediatric Glioma with BRAF V600 Mutations. Bouffet E et al. N Engl J Med. 2023 Sep 21;389(12):1108-1120. doi: 10.1056/NEJMoa2303815.
--	--

Clinical expert statement

Dabrafenib with trametinib for treating BRAF V600E mutation-positive glioma in children and young people aged 1 to 17 [ID5104]

	<ul style="list-style-type: none"> Phase II Trial of Dabrafenib Plus Trametinib in Relapsed/Refractory BRAF V600-Mutant Pediatric High-Grade Glioma. Hargrave DR et al. J Clin Oncol. 2023 Nov 20;41(33):5174-5183. doi: 10.1200/JCO.23.00558 Efficacy and Safety of Trametinib Monotherapy or in Combination With Dabrafenib in Pediatric BRAF V600-Mutant Low-Grade Glioma Bouffet et al. J Clin Oncol 2023 Jan 20;41(3):664-674. doi: 10.1200/JCO.22.01000
<p>20. Do the clinical trials on the technology reflect current UK clinical practice?</p> <ul style="list-style-type: none"> If not, how could the results be extrapolated to the UK setting? What, in your view, are the most important outcomes, and were they measured in the trials? If surrogate outcome measures were used, do they adequately predict long-term clinical outcomes? Are there any adverse effects that were not apparent in clinical trials but have come to light subsequently? 	<p>If this question relates to whether the eligibility, administration and monitoring of patients in the trial(s) of dabrafenib and trametinib for <i>BRAF V600E</i> mutation-positive LGG and HGG (Bouffet et al, 2023 NEJM, Bouffet et al, 2023 JCO, Hargrave et al, 2023) mirror that of current clinical practice in the UK when this therapy is administered off trial, then I would suggest this is the case. This is with the caveat that the inhibitor combination is administered currently in accordance with the CCLG priority indication list for MAPK inhibitors as defined in question 11. No adverse effects not apparent in the clinical trials have currently come to light.</p> <p>The trials reflected several of the key outcome measures that a clinical expert would want to assess in such clinical scenarios such as overall response rates, progression-free and overall survival rates, toxicity graded reporting, duration of clinical benefit and patient reported outcome measures.</p> <p>However, the trials have not yet been able to answer the optimal minimal duration of drug administration (two years, five years, lifelong). A single-centre Canadian analysis of <i>BRAF V600E</i> mutated LGGs treated with single agent dabrafenib, found that after discontinuation of BRAF inhibition, over 75% of patients experienced rapid progression within a median of 8-10 weeks, although response once seen in 90% of patients with rechallenge (Nobre et al, 2020).</p> <p>In addition, optimal scheduling of drug administration (daily, alternative days, daily for alternate weeks etc), and late effects of such inhibitor combination therapy remain elusive. It is hoped that the rollover trial NCT03975829 will help to address</p>

Clinical expert statement

Dabrafenib with trametinib for treating BRAF V600E mutation-positive glioma in children and young people aged 1 to 17 [ID5104]

	<p>these, particularly as, for example, new naevi and skin cancers have been attributed to both MEK and BRAF inhibitors.</p> <p>Finally, a randomised comparison of BRAF inhibitor (BRAFi) monotherapy versus combination BRAF and MEK inhibitor therapy has never been evaluated in paediatric <i>BRAF V600E</i> mutated gliomas to indicate superiority. In adult <i>BRAF V600E</i> mutated solid malignancies (particularly melanoma), phase III sizeable trials have suggested combination therapy is favoured over BRAFi monotherapy, with cross-trial comparison in adult <i>BRAF V600E</i> gliomas also favouring the combination over BRAFi monotherapy. This may reflect better protection against tumour growth escape mechanisms but this remains hypothetical. A Phase I/II study of trametinib monotherapy versus dabrafenib / trametinib combination in <i>BRAF V600E</i> mutated LGGs suggested the combination therapy offered improved objective response rates and lower adverse effect (Bouffet et al, 2023 JCO).</p> <p>References:</p> <p>Dabrafenib plus Trametinib in Pediatric Glioma with BRAF V600 Mutations. Bouffet E et al. N Engl J Med. 2023 Sep 21;389(12):1108-1120. doi: 10.1056/NEJMoa2303815.</p> <ul style="list-style-type: none"> Phase II Trial of Dabrafenib Plus Trametinib in Relapsed/Refractory BRAF V600-Mutant Pediatric High-Grade Glioma. Hargrave DR et al. J Clin Oncol. 2023 Nov 20;41(33):5174-5183. doi: 10.1200/JCO.23.00558. Outcomes of BRAF V600E Pediatric Gliomas Treated With Targeted BRAF Inhibition Nobre L et al. JCO Precis Oncol. 2020; 4: PO.19.00298. doi: 10.1200/PO.19.00298 Efficacy and Safety of Trametinib Monotherapy or in Combination With Dabrafenib in Pediatric BRAF V600-Mutant Low-Grade Glioma Bouffet et al. J Clin Oncol. 2023 Jan 20;41(3):664-674. doi: 10.1200/JCO.22.01000.
<p>21. Are you aware of any relevant evidence that might not be found by a systematic review of the trial evidence?</p>	<p>No</p>

Clinical expert statement

Dabrafenib with trametinib for treating BRAF V600E mutation-positive glioma in children and young people aged 1 to 17 [ID5104]

<p>22. Are you aware of any new evidence for the comparator treatment(s) since the publication of NICE technology appraisal guidance [TA121]?</p>	<p>This document refers to the use of Carmustine implants and temozolomide for the treatment of newly diagnosed high-grade glioma, published in 2007, the former being used exclusively in adult patients, not in the paediatric forum.</p> <p>As stated above, there is no accepted standard of care for relapsed / refractory paediatric high-grade glioma. Also, as stated above, the current UK standard of care for non-trial primary paediatric high-grade glioma is the Stupp regimen (concomitant temozolomide with radiotherapy followed by continuation temozolomide therapy, Stupp et al, 2005). This forms the basis of the current CCLG national guidelines for paediatric high-grade glioma management, 2007 (Wilkins et al, 2007).</p> <p>In 2011, the Children’s Oncology Group (COG) published the results of their ACNS0126 trial (Cohen et al, 2011), where 107 diagnosed with a paediatric high-grade glioma were enrolled into a study to evaluate the efficacy of temozolomide given alongside and following radiotherapy. The 3-year event-free survival (EFS) and overall survival (OS) rates were 11+/- 3% and 22+/- 5%, respectively and the conclusion was that temozolomide alone did not improve outcome in children with high-grade astrocytoma compared with preceding trials (e.g. CCG-945).</p> <p>In 2016, Jakacki et al produced the results of the COG ACNS0423 study which was designed to determine whether the addition of lomustine and temozolomide post-radiotherapy (along with temozolomide used concurrently with radiotherapy (akin to ACNS0126) improved progression-free survival for children with high-grade glioma. The 3-year EFS was 22%, improved compared with ACNS0126 (Jakacki et al, 2016).</p> <p>There is a strong feeling academically that dabrafenib + trametinib may be a more effective adjuvant treatment than Temozolomide when added to radiation post-surgery as most tumours will demonstrate hypomethylation of MGMT. However,</p>
--	---

Clinical expert statement

Dabrafenib with trametinib for treating BRAF V600E mutation-positive glioma in children and young people aged 1 to 17 [ID5104]

in the Phase II trial of dabrafenib and trametinib by Hargrave et al (2023), only relapsed / refractory patients were evaluated, not primary disease cases.

For paediatric low-grade gliomas (incorporating *BRAF V600E* mutant tumours) over the same timeframe of 17 years, several significant trials supporting the two first-line chemotherapy protocols that are currently employed in the UK for progressive, unresectable paediatric low-grade gliomas have been published.

In 2012 COG published its randomised phase III trial of vincristine / carboplatin (VC) versus TPCV (thioguanine, procarbazine, lomustine and vincristine). 274 children met eligibility criteria; 137 received VC and 137 received TPCV. The 5-year EFS rates were 39% for VC and 52% for TPCV (not statistically significant). However, this figure of 39% for VC dropped to 10% for *BRAF V600E* mutated LGG patients (Ater et al, 2012).

The International Society of Paediatric Oncology (SIOP) published its LGG 2004 study, which was a European randomised controlled trial of the addition of etoposide to standard vincristine and carboplatin induction as part of an 18-month treatment programme for childhood (≤ 16 years) low-grade glioma (Gnekow et al, 2017). 497 newly diagnosed patients were evaluated, 249 receiving vincristine and carboplatin (VC), while 248 received additional etoposide at induction with the other two chemotherapeutic agents (VCE). No differences between the two arms were found in term of survival and radiological response. Five-year progression-free survival (PFS) and overall survival (OS) rates for VC and VCE were 46% versus 45% and 89% versus 89% respectively. Non-progression rates of 93% for VC at 24 weeks into therapy gave support to its continuation as the European standard first line therapy.

In 2016, the Canadian Pediatric Brain Tumor Consortium Study published its Phase II trial of weekly vinblastine monotherapy for chemotherapy-naïve children

Clinical expert statement

Dabrafenib with trametinib for treating *BRAF V600E* mutation-positive glioma in children and young people aged 1 to 17 [ID5104]

with progressive low-grade glioma (Lassaletta et al, 2016). 54 children were enrolled with overall response rates of 25.9%, a 5-year PFS of 53.2% and OS of 94.4%, which was comparable with that of the SIOP LGG 2004 study.

With respect to radiotherapy for this low-grade glioma patient group, a 2014 retrospective series of 32 paediatric patients treated for progressive low-grade glioma was reported by the Massachusetts General Hospital group (Greenberger et al, 2014). An eight-year PFS and OS of 82.8% and 100% respectively was reported. However, significant neuro-cognitive decline in treated children aged below 7 years were observed, as were endocrinopathies for lesions involving the hypothalamic-pituitary axis.

References:

- Radiotherapy plus concomitant and adjuvant temozolomide for glioblastoma. Stupp R et al. N Engl J Med. 2005 Mar 10;352(10):987-96. doi: 10.1056/NEJMoa043330.
- CCLG Brain Tumour Group High Grade Glioma Guidelines Wilkins et al. Version 2.0 22nd November 2007, Available on CCLG website to members.
- Temozolomide in the treatment of high-grade gliomas in children: a report from the Children's Oncology Group. Cohen KJ et al. Neuro Oncol. 2011 Mar;13(3):317-23. doi: 10.1093/neuonc/noq191.
- Phase 2 study of concurrent radiotherapy and temozolomide followed by temozolomide and lomustine in the treatment of children with high-grade glioma: a report of the Children's Oncology Group ACNS0423 study. Jakacki RI et al. Neuro Oncol. 2016 Oct;18(10):1442-50. doi: 10.1093/neuonc/nov038.
- Phase II Trial of Dabrafenib Plus Trametinib in Relapsed/Refractory BRAF V600-Mutant Pediatric High-Grade Glioma. Hargrave DR et al. J Clin Oncol. 2023 Nov 20;41(33):5174-5183. doi: 10.1200/JCO.23.00558.
- Randomized study of two chemotherapy regimens for treatment of low-grade glioma in young children: a report from the Children's Oncology Group. Ater et al. J Clin Oncol. 2012 Jul 20;30(21):2641-7. doi: 10.1200/JCO.2011.36.6054.
- A European randomised controlled trial of the addition of etoposide to standard vincristine and carboplatin induction as part of an 18-month treatment programme for childhood (≤ 16 years) low grade glioma – A final report. Gnekow et al. Eur J Cancer. 2017 Aug; 81: 206–225. doi: 10.1016/j.ejca.2017.04.019

Clinical expert statement

Dabrafenib with trametinib for treating BRAF V600E mutation-positive glioma in children and young people aged 1 to 17 [ID5104]

	<ul style="list-style-type: none"> Phase II Weekly Vinblastine for Chemotherapy-Naïve Children With Progressive Low-Grade Glioma: A Canadian Pediatric Brain Tumor Consortium Study Lassaletta et al. J Clin Oncol. 2016 Oct 10;34(29):3537-3543. doi: 10.1200/JCO.2016.68.1585. Clinical outcomes and late endocrine, neurocognitive, and visual profiles of proton radiation for pediatric low-grade gliomas. Greenberger et al. Int J Radiat Oncol Biol Phys. 2014 Aug 1;89(5):1060-1068. doi: 10.1016/j.ijrobp.2014.04.053.
<p>23. How do data on real-world experience compare with the trial data?</p>	<p>Real-world experience data is not immediately forthcoming as compassionate / managed access scheme data from novel / molecular modification agents are often not captured routinely for retrospective cohort publication. However, the impression in the paediatric neuro-oncology community is that real-world experiences of the drug combination dabrafenib and trametinib does seem to mutually complementary to the paediatric low-grade and high-grade glioma trial findings</p>
<p>24. NICE considers whether there are any equalities issues at each stage of an evaluation. Are there any potential equality issues that should be taken into account when considering this condition and this treatment? Please explain if you think any groups of people with this condition are particularly disadvantaged.</p> <p>Equality legislation includes people of a particular age, disability, gender reassignment, marriage and civil partnership, pregnancy and maternity, race, religion or belief, sex, and sexual orientation or people with any other shared characteristics.</p> <p>Please state if you think this evaluation could</p> <ul style="list-style-type: none"> exclude any people for which this treatment is or will be licensed but who are protected by the equality legislation 	<p>This evaluation would not:</p> <ol style="list-style-type: none"> exclude any people protected by the equality legislation defined lead to recommendations that have a different impact on people protected by such equality legislation compared to the wider population lead to recommendations that have an adverse impact on people with disability. <p>Cautions and prohibitions of drug use are as defined above (section 14) but this is based on medical safety data, not borne from issues of equality.</p>

Clinical expert statement

Dabrafenib with trametinib for treating BRAF V600E mutation-positive glioma in children and young people aged 1 to 17 [ID5104]

- lead to recommendations that have a different impact on people protected by the equality legislation than on the wider population
- lead to recommendations that have an adverse impact on disabled people.

Please consider whether these issues are different from issues with current care and why.

More information on how NICE deals with equalities issues can be found in the [NICE equality scheme](#).

[Find more general information about the Equality Act and equalities issues here.](#)

Clinical expert statement

Dabrafenib with trametinib for treating BRAF V600E mutation-positive glioma in children and young people aged 1 to 17 [ID5104]

Part 2: Key messages

In up to 5 sentences, please summarise the key messages of your statement:.

1. There is currently an unmet clinical need for patients and healthcare professionals in *BRAF V600E* mutation-positive glioma affecting children and young adults; *BRAF V600E* mutated low-grade glioma patient subgroups demonstrate sub-optimal responses to current therapy, inferior survival rates, multiple relapse episodes and a cumulative toxicity burden, while high-grade glioma patients have a dismal prognosis with no recognised standard of care at relapse.
2. Dabrafenib with trametinib for patients aged 1 to 17 years with *BRAF V600E* mutation-positive glioma represents an innovative step-change in the management of primary, relapsed or refractory disease for this molecularly defined glioma subgroup, with the potential to make a significant and substantial impact on health-related benefits beyond those accounted for in quality adjusted life year calculations.
3. A published Phase II randomised, open-label trial of dabrafenib with trametinib as first-line therapy in children and young adults with *BRAF V600E* mutated low-grade glioma (ClinicalTrials.gov ID NCT02684058) reported significantly higher response rates, improved patient clinical benefit, longer progression-free survival and a safer adverse event profile compared with conventional first-line chemotherapy, therein improving the unmet clinical need.
4. Published analysis of a cohort of children and young adults with relapsed, progressive or refractory *BRAF V600E* mutated high-grade glioma, encapsulated within the Phase II trial of dabrafenib with trametinib for *BRAF V600E* mutation-positive glioma (ClinicalTrials.gov ID NCT02684058), demonstrated protracted responses and favourable survival outcomes when compared against historical paediatric high-grade glioma controls, therein improving the unmet clinical need.
5. The U.S. Food and Drug Administration have already approved dabrafenib and trametinib for 2 corresponding paediatric indications: the treatment of paediatric patients 1 year of age and older with low-grade glioma (LGG) with a *BRAF V600E* mutation who require systemic therapy (16 March 2023) and paediatric patients ≥ 6 years of age with unresectable or metastatic solid tumours with *BRAF V600E* mutation who have progressed following prior treatment and have no satisfactory alternative treatment options (June 22, 2022).

Thank you for your time.

Clinical expert statement

Dabrafenib with trametinib for treating *BRAF V600E* mutation-positive glioma in children and young people aged 1 to 17 [ID5104]

Your privacy

The information that you provide on this form will be used to contact you about the topic above.

Please tick this box if you would like to receive information about other NICE topics.

For more information about how we process your personal data please see our [privacy notice](#).

Clinical expert statement

Dabrafenib with trametinib for treating BRAF V600E mutation-positive glioma in children and young people aged 1 to 17 [ID5104]

Single Technology Appraisal

Dabrafenib with trametinib for treating BRAF V600E mutation-positive glioma in children and young people aged 1 to 17 [ID5104]

Clinical expert statement

Information on completing this form

In [part 1](#) we are asking for your views on this technology. The text boxes will expand as you type.

In [part 2](#) we are asking you to provide 5 summary sentences on the main points contained in this document.

Please do not embed documents (such as a PDF) in a submission because this may lead to the information being mislaid or make the submission unreadable. Please type information directly into the form.

Do not include medical information about yourself or another person that could identify you or the other person.

We are committed to meeting the requirements of copyright legislation. If you want to include **journal articles** in your submission you must have copyright clearance for these articles. We can accept journal articles in NICE Docs. For copyright reasons, we will have to return forms that have attachments without reading them. You can resubmit your form without attachments, but it must be sent by the deadline.

Combine all comments from your organisation (if applicable) into 1 response. We cannot accept more than 1 set of comments from each organisation.

Clinical expert statement

Dabrafenib with trametinib for treating BRAF V600E mutation-positive glioma in children and young people aged 1 to 17 [ID5104]

Please underline all confidential information, and separately highlight information that is submitted as 'confidential [CON]' in turquoise, and all information submitted as 'depersonalised data [DPD]' in pink. If confidential information is submitted, please also send a second version of your comments with that information redacted. See [Health technology evaluations: interim methods and process guide for the proportionate approach to technology appraisals](#) (section 3.2) for more information.

The deadline for your response is **5pm on 20 February 2024**. Please log in to your NICE Docs account to upload your completed form, as a Word document (not a PDF).

Thank you for your time.

We reserve the right to summarise and edit comments received, or not to publish them at all, if we consider the comments are too long, or publication would be unlawful or otherwise inappropriate.

Comments received are published in the interests of openness and transparency, and to promote understanding of how recommendations are developed. The comments are published as a record of the comments we received, and are not endorsed by NICE, its officers or advisory committees.

Clinical expert statement

Dabrafenib with trametinib for treating BRAF V600E mutation-positive glioma in children and young people aged 1 to 17 [ID5104]

Part 1: Treating BRAF V600E mutation-positive glioma in children and young people aged 1 to 17 and current treatment options

Table 1 About you, aim of treatment, place and use of technology, sources of evidence and equality

1. Your name	Dr Lynley Marshall
2. Name of organisation	The Royal Marsden NHS Foundation Trust and the Institute of Cancer Research
3. Job title or position	Consultant in Paediatric and Adolescent Oncology Drug Development; Clinical Research Lead
4. Are you (please tick all that apply)	<input type="checkbox"/> An employee or representative of a healthcare professional organisation that represents clinicians? <input checked="" type="checkbox"/> A specialist in the treatment of children and young people with glioma? <input checked="" type="checkbox"/> A specialist in the clinical evidence base for glioma or dabrafenib and trametinib? <input type="checkbox"/> Other (please specify):
5. Do you wish to agree with your nominating organisation's submission? (We would encourage you to complete this form even if you agree with your nominating organisation's submission)	<input type="checkbox"/> Yes, I agree with it <input type="checkbox"/> No, I disagree with it <input type="checkbox"/> I agree with some of it, but disagree with some of it <input checked="" type="checkbox"/> Other (they did not submit one, I do not know if they submitted one etc.) I have not yet seen nominating organisation's submission.
6. If you wrote the organisation submission and/or do not have anything to add, tick here. (If you tick this box, the rest of this form will be deleted after submission)	<input type="checkbox"/> Yes

Clinical expert statement

Dabrafenib with trametinib for treating BRAF V600E mutation-positive glioma in children and young people aged 1 to 17 [ID5104]

<p>7. Please disclose any past or current, direct or indirect links to, or funding from, the tobacco industry.</p>	<p>None</p>
<p>8. What is the main aim of treatment for BRAF V600E mutation-positive glioma in children and young people aged 1 to 17? (For example, to stop progression, to improve mobility, to cure the condition, or prevent progression or disability)</p>	<p>BRAFv600E mutant high-grade glioma: -To shrink tumour and improve neurological function if possible; to stabilise tumour and stop or at least delay disease progression in children and young people; to add life years and improve quality of life.</p> <p>BRAFv600E mutant low-grade glioma: - To shrink tumour and improve neurological function if possible; to stabilise tumour and stop or at least delay disease progression; to avoid or at least delay the need for radiotherapy (and potentially also cytotoxic chemotherapy) in children and young people; to add life years and improve quality of life.</p>
<p>9. What do you consider a clinically significant treatment response? (For example, a reduction in tumour size by x cm, or a reduction in disease activity by a certain amount)</p>	<p>The value of prolonged disease stabilisation, even in the absence of tumour shrinkage, should not be underestimated for these BRAFv600E mutant gliomas, both high grade and low grade. The absence of disease progression, clinically and radiologically, is clinically significant.</p>
<p>10. In your view, is there an unmet need for patients and healthcare professionals in BRAF V600E mutation-positive glioma in children and young people aged 1 to 17?</p>	<p>Yes</p>
<p>11. How is BRAF V600E mutation-positive glioma in children and young people aged 1 to 17 currently treated in the NHS?</p> <ul style="list-style-type: none"> • Are any clinical guidelines used in the treatment of the condition, and if so, which? • Is the pathway of care well defined? Does it vary or are there differences of opinion between professionals across the NHS? (Please state if your experience is from outside England.) 	<p>BRAFv600E mutant high-grade glioma in patients \geq 4 years of age: - Maximal safe neurosurgical resection followed by chemoradiotherapy (radiotherapy, usually 54Gy in 30 fractions over 6 weeks) with daily concomitant oral temozolomide, followed by 12 cycles of adjuvant oral temozolomide (given on days 1-5 of every 28 day cycle). -At first relapse: treatment with Dabrafenib + Trametinib if clinical trial/managed access supply available; otherwise with second line chemotherapy with either PCV chemotherapy (procarbazine, CCNU, vincristine) or single agent CCNU</p>

Clinical expert statement

Dabrafenib with trametinib for treating BRAF V600E mutation-positive glioma in children and young people aged 1 to 17 [ID5104]

<ul style="list-style-type: none"> • What impact would the technology have on the current pathway of care? 	<p>-At second relapse and beyond: treatment with Dabrafenib + Trametinib if clinical trial/managed access supply available and not previously received; otherwise with PCV or single agent CCNU if not yet received; other relevant open phase I/II trials if available, or palliative oral etoposide.</p> <p>BRAFv600E mutant high-grade glioma in patients < 4 years of age:</p> <p>- Maximal safe neurosurgical resection followed by ‘Baby Brain’ type multi-agent chemotherapy protocols (e.g. Baby SIOP or Baby SFOP) for around 18 months; to avoid/delay irradiation of young brains.</p> <p>-At first relapse: treatment with Dabrafenib + Trametinib if clinical trial/managed access supply available; otherwise with second line chemotherapy with either PCV chemotherapy (procarbazine, CCNU, vincristine) or single agent CCNU</p> <p>-At second relapse and beyond: treatment with Dabrafenib + Trametinib if clinical trial/managed access supply available and not previously received; otherwise with PCV or single agent CCNU if not yet received; other relevant open phase I/II trials if available, or palliative oral etoposide.</p> <p>BRAFv600E mutant low-grade glioma in patients ≥ 8 years of age:</p> <p>-Maximal safe neurosurgical resection and if not fully resected, consideration of adjuvant therapy with either systemic anti-cancer therapy (vincristine and carboplatin for 18 months (usually first choice; weekly vinblastine for 12 months is also an option) or radiotherapy.</p> <p>-At first relapse/progression: vinblastine or vincristine + carboplatin (whichever not given before).</p> <p>-At second relapse/progression: treatment with Dabrafenib + Trametinib if clinical trial/managed access supply available; otherwise consider bevacizumab + irinotecan; or radiotherapy .</p> <p>- At third relapse/progression and beyond: consider relevant early phase clinical trials if available, or whichever of above therapies not yet given, or can</p>
---	---

Clinical expert statement

Dabrafenib with trametinib for treating BRAF V600E mutation-positive glioma in children and young people aged 1 to 17 [ID5104]

	<p>rechallenge with vincristine/carboplatin or vinblastine (unless toxicities preclude e.g. platinum-induced nephrotoxicity or hearing loss).</p> <p>BRAFv600E mutant low-grade glioma in patients < 8 years of age: - as for patients > 8 years but aim to avoid or delay radiotherapy, so may change the order depending on age of child.</p> <p>NOTE: With the rollout of the upfront LOGGIC-FIREFLY Phase 3 clinical trial for Low grade glioma there is a randomisation between an arm of systemic chemotherapy with vincristine and carboplatin or vinblastine (investigator choice) vs the pan-RAF inhibitor Tovorafenib and can include patients across the age spectrum 1-17 years.</p>
<p>12. Will the technology be used (or is it already used) in the same way as current care in NHS clinical practice?</p> <ul style="list-style-type: none"> • How does healthcare resource use differ between the technology and current care? • In what clinical setting should the technology be used? (for example, primary or secondary care, specialist clinic) • What investment is needed to introduce the technology? (for example, for facilities, equipment, or training) 	<p>To date, access to Dabrafenib and Trametinib for UK NHS patients aged 1-17 years with BRAFv600E mutant glioma has been limited to those who have received it within clinical trials or via managed access programmes run by Novartis (with limitations on numbers). If available they would be used more readily in earlier lines of treatment to spare toxicity.</p> <p>Dabrafenib and Trametinib are outpatient-based therapies, as are most of the other regimens in use in paediatric glioma (some Baby Brain courses require inpatient admission); the key difference is that there are far fewer inpatient admissions needed for supportive care (e.g. febrile neutropenia episodes etc) related to Dabrafenib and Trametinib which are usually very well tolerated, with adequate outpatient supportive care management of toxicities (e.g. dermatological side effects). They do require monitoring of cardiac function and ophthalmological assessments, but the overall number of outpatient appointments, medical/nursing/hospital time is reduced for patients stable on therapy (which they may be for many years).</p>

Clinical expert statement

Dabrafenib with trametinib for treating BRAF V600E mutation-positive glioma in children and young people aged 1 to 17 [ID5104]

	<p>The drugs should be administered with oversight from specialist tertiary paediatric/TYA oncologists.</p> <p>If rolled out more widely this should not change, but more clinicians would need to be trained on their use, and resource would be needed to ensure adequate safety monitoring (cardiac echo, ophthalmology review etc) – likely to be offset by fewer hospital admissions, need for infusional systemic chemotherapy, radiotherapy etc.</p>
<p>13. Do you expect the technology to provide clinically meaningful benefits compared with current care?</p> <ul style="list-style-type: none"> Do you expect the technology to increase length of life more than current care? Do you expect the technology to increase health-related quality of life more than current care? 	<p>I believe that the introduction of Dabrafenib and Trametinib for BRAFv600E mutant glioma will improve length of life (especially for BRAFv600E-mutant HGG, where prognosis is currently poor) and particularly health-related quality of life compared to current care; in a paediatric and adolescent population that is expected to have significant impact for future society in terms of being productive/economically active members of society; fewer chronic late effects due to toxicity; reduced hospitalisation costs etc.</p>
<p>14. Are there any groups of people for whom the technology would be more or less effective (or appropriate) than the general population?</p>	<p>Relevant to all paediatric patients with BRAFv600E mutant glioma.</p>
<p>15. Will the technology be easier or more difficult to use for patients or healthcare professionals than current care? Are there any practical implications for its use?</p> <p>(For example, any concomitant treatments needed, additional clinical requirements, factors affecting patient acceptability or ease of use or additional tests or monitoring needed)</p>	<p>Even with additional monitoring (cardiac, ophthalmological), Dabrafenib and Trametinib would be easier for patients and healthcare professionals; reduction in toxicity and in number and frequency of outpatient/daycare and inpatient hospital admissions.</p>

Clinical expert statement

Dabrafenib with trametinib for treating BRAF V600E mutation-positive glioma in children and young people aged 1 to 17 [ID5104]

<p>16. Will any rules (informal or formal) be used to start or stop treatment with the technology? Do these include any additional testing?</p>	<p>Standard relevant safety monitoring for the Dabrafenib and Trametinib: prior to treatment, at defined time points through treatment (with options to dose reduce or hold/stop if toxicity develops) ; discontinuation for progressive disease on treatment.</p>
<p>17. Do you consider that the use of the technology will result in any substantial health-related benefits that are unlikely to be included in the quality-adjusted life year (QALY) calculation?</p> <ul style="list-style-type: none"> Do the instruments that measure quality of life fully capture all the benefits of the technology or have some been missed? For example, the treatment regimen may be more easily administered (such as an oral tablet or home treatment) than current standard of care 	<p>Dabrafenib and Trametinib are oral drugs taken at home whereas some of the alternatives are intravenous and require significantly more hospital time – including daycare time, pharmacy time and inpatient for supportive care for toxicities e.g. febrile neutropenia.</p>
<p>18. Do you consider the technology to be innovative in its potential to make a significant and substantial impact on health-related benefits and how might it improve the way that current need is met?</p> <ul style="list-style-type: none"> Is the technology a ‘step-change’ in the management of the condition? Does the use of the technology address any particular unmet need of the patient population? 	<p>Dabrafenib and Trametinib represent a step-change in the management of BRAFv600E glioma; they have truly revolutionised the order in which we consider treatment options for these diseases.</p>
<p>19. How do any side effects or adverse effects of the technology affect the management of the condition and the patient’s quality of life?</p>	<p>Whilst there are potential side effects of Dabrafenib and Trametinib, the most notable being skin toxicities (and rarely skin cancers although much rarer in children than in adults, who have had longer lifetimes of sun exposure), risk of cardiotoxicity and risk of ophthalmic side effects, the risk of infection and need for blood product administration is much lower than with systemic chemotherapy, and the risk of endocrine side effects and impact on neurocognition is much lower than with radiotherapy – so delaying the need for these other therapies, or avoiding some of them completely is in the patient best interests even at the expense of manageable side effects.</p>

Clinical expert statement

Dabrafenib with trametinib for treating BRAF V600E mutation-positive glioma in children and young people aged 1 to 17 [ID5104]

<p>20. Do the clinical trials on the technology reflect current UK clinical practice?</p> <ul style="list-style-type: none"> • If not, how could the results be extrapolated to the UK setting? • What, in your view, are the most important outcomes, and were they measured in the trials? • If surrogate outcome measures were used, do they adequately predict long-term clinical outcomes? • Are there any adverse effects that were not apparent in clinical trials but have come to light subsequently? 	<p>Yes, they reflect current UK practice. Meaningful increase in progression-free survival and overall survival, with manageable toxicities in an outpatient setting.</p>
<p>21. Are you aware of any relevant evidence that might not be found by a systematic review of the trial evidence?</p>	<p>No</p>
<p>22. Are you aware of any new evidence for the comparator treatment(s) since the publication of NICE technology appraisal guidance [TA121]?</p>	<p>No</p>
<p>23. How do data on real-world experience compare with the trial data?</p>	<p>Real world experience demonstrates that Dabrafenib and Trametinib can have benefit and are tolerable in patients with BRAFv600E mutant glioma who may not be as fit as standard clinical trial participants (who have to meet higher performance status/organ toxicity inclusion criteria and none of the exclusion criteria).</p>
<p>24. NICE considers whether there are any equalities issues at each stage of an evaluation. Are there any potential equality issues that should be taken into account when considering this condition and this treatment? Please explain if you think any groups of people with this condition are particularly disadvantaged.</p>	<p>None that I am aware of.</p> <p>PART 2: KEY MESSAGES: (I am entering these here as the section below headed 'Part 2: Key messages' does not allow me to type/enter any text at all).</p> <ol style="list-style-type: none"> 1. Dabrafenib and Trametinib are safe, well-tolerated, outpatient-deliverable oral drugs for the paediatric and adolescent population

Clinical expert statement

Dabrafenib with trametinib for treating BRAF V600E mutation-positive glioma in children and young people aged 1 to 17 [ID5104]

Equality legislation includes people of a particular age, disability, gender reassignment, marriage and civil partnership, pregnancy and maternity, race, religion or belief, sex, and sexual orientation or people with any other shared characteristics.

Please state if you think this evaluation could

- exclude any people for which this treatment is or will be licensed but who are protected by the equality legislation
- lead to recommendations that have a different impact on people protected by the equality legislation than on the wider population
- lead to recommendations that have an adverse impact on disabled people.

Please consider whether these issues are different from issues with current care and why.

More information on how NICE deals with equalities issues can be found in the [NICE equality scheme](#).

[Find more general information about the Equality Act and issues here.](#)

with BRAFv600E mutant glioma (including high grade glioma and low grade glioma).

- 2. They are efficacious in a significant proportion of patients with respect to disease response and stopping/delaying disease progression/relapse, sometimes for many years. The value of stable disease/absence of disease progression should not be underestimated in these populations.**
- 3. They reduce hospital visits and time overall (clinic, daycare, inpatient including for supportive care management of toxicities), improve health-related quality of life for patients and parents/carers and are overall expected to represent cost saving to the NHS when the long term toxicities of current alternative treatments (systemic chemotherapy; radiotherapy) are considered.**
- 4. The existence of paediatric-friendly oral formulations even for very young patients is extremely important.**

Clinical expert statement

Dabrafenib with trametinib for treating BRAF V600E mutation-positive glioma in children and young people aged 1 to 17 [ID5104]

Part 2: Key messages

In up to 5 sentences, please summarise the key messages of your statement:

Click or tap here to enter text.

Click or tap here to enter text.

Click or tap here to enter text.

Click or tap here to enter text.

Click or tap here to enter text.

Thank you for your time.

Your privacy

The information that you provide on this form will be used to contact you about the topic above.

Please tick this box if you would like to receive information about other NICE topics.

For more information about how we process your personal data please see our [privacy notice](#).

Clinical expert statement

Dabrafenib with trametinib for treating BRAF V600E mutation-positive glioma in children and young people aged 1 to 17 [ID5104]

Single Technology Appraisal

Dabrafenib with trametinib for treating BRAF V600E mutation-positive glioma in children and young people aged 1 to 17 [ID5104]

Patient expert statement

Thank you for agreeing to give us your views on this treatment and its possible use in the NHS.

Your comments are really valued. You can provide a unique perspective on conditions and their treatment that is not typically available from other sources

Information on completing this form

In [part 1](#) we are asking you about living with BRAF V600E mutation-positive glioma or caring for a patient with BRAF V600E mutation-positive glioma. The text boxes will expand as you type.

In [part 2](#) we are asking you to provide 5 summary sentences on the main points contained in this document.

Help with completing this form

If you have any questions or need help with completing this form please email the public involvement (PIP) team at pip@nice.org.uk (please include the ID number of your appraisal in any correspondence to the PIP team).

Patient expert statement

Dabrafenib with trametinib for treating BRAF V600E mutation-positive glioma in children and young people aged 1 to 17 [ID5104]

Please use this questionnaire with our [hints and tips for patient experts](#). You can also refer to the [Patient Organisation submission guide](#). **You do not have to answer every question** – they are prompts to guide you. There is also an opportunity to raise issues that are important to patients that you think have been missed and want to bring to the attention of the committee.

Please do not embed documents (such as a PDF) in a submission because this may lead to the information being mislaid or make the submission unreadable. Please type information directly into the form.

We are committed to meeting the requirements of copyright legislation. If you want to include **journal articles** in your submission you must have copyright clearance for these articles. We can accept journal articles in NICE Docs. For copyright reasons, we will have to return forms that have attachments without reading them. You can resubmit your form without attachments, but it must be sent by the deadline.

Your response should not be longer than 15 pages.

The deadline for your response is **5pm on 20 February 2024**. Please log in to your NICE Docs account to upload your completed form, as a Word document (not a PDF).

Thank you for your time.

We reserve the right to summarise and edit comments, or not to publish them at all, if we consider the comments are too long, or publication would be unlawful or otherwise inappropriate.

Comments received are published in the interests of openness and transparency, and to promote understanding of how recommendations are developed. The comments are published as a record of the comments we received, and are not endorsed by NICE, its officers or advisory committees.

Patient expert statement

Dabrafenib with trametinib for treating BRAF V600E mutation-positive glioma in children and young people aged 1 to 17 [ID5104]

Part 1: Living with this condition or caring for a patient with BRAF V600E mutation-positive glioma

Table 1 About you, BRAF V600E mutation-positive glioma, current treatments and equality

1. Your name	Sukhdip Sandhu
2. Are you (please tick all that apply)	<input type="checkbox"/> A patient with BRAF V600E mutation-positive glioma? <input type="checkbox"/> A patient with experience of the treatment being evaluated? <input type="checkbox"/> A carer of a patient with BRAF V600E mutation-positive glioma? <input type="checkbox"/> A patient organisation employee or volunteer? <input checked="" type="checkbox"/> Other (please specify): Parent of son who has passed away from high grade Glioma
3. Name of your nominating organisation	The Brain Tumour Charity
4. Has your nominating organisation provided a submission? (please tick all options that apply)	<input type="checkbox"/> No (please review all the questions and provide answers when possible) <input checked="" type="checkbox"/> Yes, my nominating organisation has provided a submission <input checked="" type="checkbox"/> I agree with it and do not wish to complete a patient expert statement <input checked="" type="checkbox"/> Yes, I authored / was a contributor to my nominating organisations submission <input type="checkbox"/> I agree with it and do not wish to complete this statement <input type="checkbox"/> I agree with it and will be completing
5. How did you gather the information included in your statement? (please tick all that apply)	<input type="checkbox"/> I am drawing from personal experience

Patient expert statement

Dabrafenib with trametinib for treating BRAF V600E mutation-positive glioma in children and young people aged 1 to 17 [ID5104]

	<input type="checkbox"/> I have other relevant knowledge or experience (for example, I am drawing on others' experiences). Please specify what other experience: <input type="checkbox"/> I have completed part 2 of the statement after attending the expert engagement teleconference <input type="checkbox"/> I have completed part 2 of the statement but was not able to attend the expert engagement teleconference <input type="checkbox"/> I have not completed part 2 of the statement
<p>6. What is your experience of living with BRAF V600E mutation-positive glioma? If you are a carer (for someone with BRAF V600E mutation-positive glioma) please share your experience of caring for them</p>	
<p>7a. What do you think of the current treatments and care available for BRAF V600E mutation-positive glioma on the NHS? 7b. How do your views on these current treatments compare to those of other people that you may be aware of?</p>	
<p>8. If there are disadvantages for patients of current NHS treatments for BRAF V600E mutation-positive glioma (for example, how they are given or taken, side effects of treatment, and any others) please describe these</p>	
<p>9a. If there are advantages of dabrafenib with trametinib over current treatments on the NHS please describe these. For example, the effect on your quality of life, your ability to continue work, education, self-care, and care for others?</p>	

Patient expert statement

Dabrafenib with trametinib for treating BRAF V600E mutation-positive glioma in children and young people aged 1 to 17 [ID5104]

<p>9b. If you have stated more than one advantage, which one(s) do you consider to be the most important, and why?</p> <p>9c. Does dabrafenib with trametinib help to overcome or address any of the listed disadvantages of current treatment that you have described in question 8? If so, please describe these</p>	
<p>10. If there are disadvantages of dabrafenib with trametinib over current treatments on the NHS please describe these.</p> <p>For example, are there any risks with dabrafenib with trametinib? If you are concerned about any potential side effects you have heard about, please describe them and explain why</p>	
<p>11. Are there any groups of patients who might benefit more from dabrafenib with trametinib or any who may benefit less? If so, please describe them and explain why</p> <p>Consider, for example, if patients also have other health conditions (for example difficulties with mobility, dexterity or cognitive impairments) that affect the suitability of different treatments</p>	
<p>12. Are there any potential equality issues that should be taken into account when considering BRAF V600E mutation-positive glioma and dabrafenib with trametinib? Please explain if you think any groups of people with this condition are particularly disadvantage</p>	

Patient expert statement

Dabrafenib with trametinib for treating BRAF V600E mutation-positive glioma in children and young people aged 1 to 17 [ID5104]

<p>Equality legislation includes people of a particular age, disability, gender reassignment, marriage and civil partnership, pregnancy and maternity, race, religion or belief, sex, and sexual orientation or people with any other shared characteristics</p> <p>More information on how NICE deals with equalities issues can be found in the NICE equality scheme Find more general information about the Equality Act and equalities issues here.</p>	
<p>13. Are there any other issues that you would like the committee to consider?</p>	

Patient expert statement

Dabrafenib with trametinib for treating BRAF V600E mutation-positive glioma in children and young people aged 1 to 17 [ID5104]

Part 2: Key messages

In up to 5 sentences, please summarise the key messages of your statement:

- Click or tap here to enter text.
- Click or tap here to enter text.
- Click or tap here to enter text.
- Click or tap here to enter text.
- Click or tap here to enter text.

Thank you for your time.

Your privacy

The information that you provide on this form will be used to contact you about the topic above.

Please tick this box if you would like to receive information about other NICE topics.

For more information about how we process your personal data please see [NICE's privacy notice](#).

Patient expert statement

Dabrafenib with trametinib for treating BRAF V600E mutation-positive glioma in children and young people aged 1 to 17 [ID5104]

Single Technology Appraisal

Dabrafenib with trametinib for treating BRAF V600E mutation-positive glioma in children and young people aged 1 to 17 [ID5104]

Patient expert statement

Thank you for agreeing to give us your views on this treatment and its possible use in the NHS.

Your comments are really valued. You can provide a unique perspective on conditions and their treatment that is not typically available from other sources

Information on completing this form

In [part 1](#) we are asking you about living with BRAF V600E mutation-positive glioma or caring for a patient with BRAF V600E mutation-positive glioma. The text boxes will expand as you type.

In [part 2](#) we are asking you to provide 5 summary sentences on the main points contained in this document.

Help with completing this form

If you have any questions or need help with completing this form please email the public involvement (PIP) team at pip@nice.org.uk (please include the ID number of your appraisal in any correspondence to the PIP team).

Patient expert statement

Dabrafenib with trametinib for treating BRAF V600E mutation-positive glioma in children and young people aged 1 to 17 [ID5104]

Please use this questionnaire with our [hints and tips for patient experts](#). You can also refer to the [Patient Organisation submission guide](#). **You do not have to answer every question** – they are prompts to guide you. There is also an opportunity to raise issues that are important to patients that you think have been missed and want to bring to the attention of the committee.

Please do not embed documents (such as a PDF) in a submission because this may lead to the information being mislaid or make the submission unreadable. Please type information directly into the form.

We are committed to meeting the requirements of copyright legislation. If you want to include **journal articles** in your submission you must have copyright clearance for these articles. We can accept journal articles in NICE Docs. For copyright reasons, we will have to return forms that have attachments without reading them. You can resubmit your form without attachments, but it must be sent by the deadline.

Your response should not be longer than 15 pages.

The deadline for your response is **5pm on 20 February 2024**. Please log in to your NICE Docs account to upload your completed form, as a Word document (not a PDF).

Thank you for your time.

We reserve the right to summarise and edit comments, or not to publish them at all, if we consider the comments are too long, or publication would be unlawful or otherwise inappropriate.

Comments received are published in the interests of openness and transparency, and to promote understanding of how recommendations are developed. The comments are published as a record of the comments we received, and are not endorsed by NICE, its officers or advisory committees.

Patient expert statement

Dabrafenib with trametinib for treating BRAF V600E mutation-positive glioma in children and young people aged 1 to 17 [ID5104]

Part 1: Living with this condition or caring for a patient with BRAF V600E mutation-positive glioma

Table 1 About you, BRAF V600E mutation-positive glioma, current treatments and equality

1. Your name	Clare Jackson
2. Are you (please tick all that apply)	<input type="checkbox"/> A patient with BRAF V600E mutation-positive glioma? <input type="checkbox"/> A patient with experience of the treatment being evaluated? <input type="checkbox"/> A carer of a patient with BRAF V600E mutation-positive glioma? <input checked="" type="checkbox"/> A patient organisation employee or volunteer? <input type="checkbox"/> Other (please specify):
3. Name of your nominating organisation	The Brain Tumour Charity
4. Has your nominating organisation provided a submission? (please tick all options that apply)	<input type="checkbox"/> No (please review all the questions and provide answers when possible) <input checked="" type="checkbox"/> Yes, my nominating organisation has provided a submission <input checked="" type="checkbox"/> I agree with it and do not wish to complete a patient expert statement <input type="checkbox"/> Yes, I authored / was a contributor to my nominating organisations submission <input type="checkbox"/> I agree with it and do not wish to complete this statement <input type="checkbox"/> I agree with it and will be completing
5. How did you gather the information included in your statement? (please tick all that apply)	<input type="checkbox"/> I am drawing from personal experience <input type="checkbox"/> I have other relevant knowledge or experience (for example, I am drawing on others' experiences). Please specify what other experience:

Patient expert statement

Dabrafenib with trametinib for treating BRAF V600E mutation-positive glioma in children and young people aged 1 to 17 [ID5104]

	<input type="checkbox"/> I have completed part 2 of the statement after attending the expert engagement teleconference <input type="checkbox"/> I have completed part 2 of the statement but was not able to attend the expert engagement teleconference <input checked="" type="checkbox"/> I have not completed part 2 of the statement
<p>6. What is your experience of living with BRAF V600E mutation-positive glioma? If you are a carer (for someone with BRAF V600E mutation-positive glioma) please share your experience of caring for them</p>	
<p>7a. What do you think of the current treatments and care available for BRAF V600E mutation-positive glioma on the NHS? 7b. How do your views on these current treatments compare to those of other people that you may be aware of?</p>	
<p>8. If there are disadvantages for patients of current NHS treatments for BRAF V600E mutation-positive glioma (for example, how they are given or taken, side effects of treatment, and any others) please describe these</p>	
<p>9a. If there are advantages of dabrafenib with trametinib over current treatments on the NHS please describe these. For example, the effect on your quality of life, your ability to continue work, education, self-care, and care for others?</p>	

Patient expert statement

Dabrafenib with trametinib for treating BRAF V600E mutation-positive glioma in children and young people aged 1 to 17 [ID5104]

<p>9b. If you have stated more than one advantage, which one(s) do you consider to be the most important, and why?</p> <p>9c. Does dabrafenib with trametinib help to overcome or address any of the listed disadvantages of current treatment that you have described in question 8? If so, please describe these</p>	
<p>10. If there are disadvantages of dabrafenib with trametinib over current treatments on the NHS please describe these.</p> <p>For example, are there any risks with dabrafenib with trametinib? If you are concerned about any potential side effects you have heard about, please describe them and explain why</p>	
<p>11. Are there any groups of patients who might benefit more from dabrafenib with trametinib or any who may benefit less? If so, please describe them and explain why</p> <p>Consider, for example, if patients also have other health conditions (for example difficulties with mobility, dexterity or cognitive impairments) that affect the suitability of different treatments</p>	
<p>12. Are there any potential equality issues that should be taken into account when considering BRAF V600E mutation-positive glioma and dabrafenib with trametinib? Please explain if you think any groups of people with this condition are particularly disadvantaged</p>	

Patient expert statement

Dabrafenib with trametinib for treating BRAF V600E mutation-positive glioma in children and young people aged 1 to 17 [ID5104]

<p>Equality legislation includes people of a particular age, disability, gender reassignment, marriage and civil partnership, pregnancy and maternity, race, religion or belief, sex, and sexual orientation or people with any other shared characteristics</p> <p>More information on how NICE deals with equalities issues can be found in the NICE equality scheme Find more general information about the Equality Act and equalities issues here.</p>	
<p>13. Are there any other issues that you would like the committee to consider?</p>	

Patient expert statement

Dabrafenib with trametinib for treating BRAF V600E mutation-positive glioma in children and young people aged 1 to 17 [ID5104]

Part 2: Key messages

In up to 5 sentences, please summarise the key messages of your statement:

- Click or tap here to enter text.
- Click or tap here to enter text.
- Click or tap here to enter text.
- Click or tap here to enter text.
- Click or tap here to enter text.

Thank you for your time.

Your privacy

The information that you provide on this form will be used to contact you about the topic above.

Please tick this box if you would like to receive information about other NICE topics.

For more information about how we process your personal data please see [NICE's privacy notice](#).

Patient expert statement

Dabrafenib with trametinib for treating BRAF V600E mutation-positive glioma in children and young people aged 1 to 17 [ID5104]



Dabrafenib with trametinib for treating BRAF V600E mutation-positive glioma in children and young people aged 1 to 17: A Single Technology Appraisal

Produced by Sheffield Centre of Health and Related Research (SCHARR), School of Medicine and Population Health, University of Sheffield

Authors Dan Pollard, Lecturer, SCHARR, School of Medicine and Population Health, University of Sheffield, Sheffield, UK

Munira Essat, Senior Research Fellow, SCHARR, School of Medicine and Population Health, University of Sheffield, Sheffield, UK

Kate (Shijie) Ren, Senior Research Fellow, SCHARR, School of Medicine and Population Health, University of Sheffield, Sheffield, UK

Andrew Rawdin, Research Assistant, SCHARR, School of Medicine and Population Health, University of Sheffield, Sheffield, UK

Gamze Nalbant, Research Associate, SCHARR, School of Medicine and Population Health, University of Sheffield, Sheffield, UK

Jessica Forsyth, Research Associate, SCHARR, School of Medicine and Population Health, University of Sheffield, Sheffield, UK

Ruth Wong, Information Specialist, SCHARR, School of Medicine and Population Health, University of Sheffield, Sheffield, UK

Colin Watts, Institute of Cancer and Genomic Sciences, University of Birmingham, Birmingham, UK

Simon Bailey, Great North Children's Hospital, Newcastle Hospitals NHS foundation trust, Newcastle, UK

Confidential until published

Correspondence Dan Pollard, Lecturer, SCHARR, Division of Population Health, University of
Author Sheffield, Sheffield, UK

Date completed (20/12/2023)

Source of funding: This report was commissioned by the NIHR Evidence Synthesis Programme as project number NIHR136143.

Declared competing interests of the authors

Kate (Shijie) Ren has conducted work for Pfizer in an unrelated condition and unrelated treatment (Tofacitinib for Moderate-to-Severe Ulcerative Colitis). None of the other authors has any conflicts of interest to declare.

Acknowledgements

We would also like to thank Matt Stevenson, SCHARR, for providing comments on the draft report and Gill Rooney, Programme Manager, SCHARR, for providing administrative support and in preparing and formatting the report.

Rider on responsibility for report

The views expressed in this report are those of the authors and not necessarily those of the NIHR Evidence Synthesis Programme. Any errors are the responsibility of the authors.

This report should be referenced as follows:

Dabrafenib with trametinib for treating BRAF V600E mutation-positive glioma in children and young people aged 1 to 17: A Single Technology Appraisal. Sheffield Centre for Health and Related Research (SCHARR), 2023.

Contributions of authors

Dan Pollard and Andrew Rawdin critiqued the health economic analysis submitted by the company. Munira Essat and Gamze Nalbant summarised and critiqued the clinical effectiveness data reported within the company's submission. Kate (Shijie) Ren and Jessica Forsyth critiqued the statistical aspects of the submission. Ruth Wong critiqued the company's search strategy. Colin Watts and Simon Bailey provided clinical advice on all aspects of this project to the methodological specialists. All authors were involved in drafting and commenting on the final report.

Copyright belongs to University of Sheffield

Confidential until published

Copyright is retained by Novartis for Tables 5,6,7,8,9,10,11,12,13,14,15,16,17,18,19,20,21,22,23,24,25,26,28,33,34,36,38,42,43,54,56,58,59 and figures 4, 5, 6, 7, 8, 9,10,11,12,13,14,22,23,24,25,26,27,28,29,30, 31, 32, 33,34.

CONTENTS

	ABBREVIATIONS	1
1	EXECUTIVE SUMMARY	3
1.1	Overview of the EAG’s key issues	4
1.2	Overview of key model outcomes	5
1.3	The decision problem: summary of the EAG’s key issues	6
1.4	The clinical effectiveness evidence: summary of the EAG’s key issues	8
1.5	The cost-effectiveness evidence: summary of the EAG’s key issues	10
1.6	Other key issues: summary of the EAG’s view	11
1.7	Summary of EAG’s preferred assumptions and resulting ICER	12
2	BACKGROUND	15
2.1	Critique of company’s description of underlying health problem	15
2.2	Critique of company’s overview of current service provision	16
2.3	Critique of company’s definition of the decision problem	19
3	CLINICAL EFFECTIVENESS	22
3.1	Critique of the methods of review(s)	22
3.2	Critique of trials of the technology of interest, its analysis and interpretation	25
3.3	Meta-analysis	64
3.4	Critique of trials identified and included in the indirect comparison: HGG	64
3.5	Description and critique of the indirect comparison: HGG	81
3.6	Additional work on clinical effectiveness undertaken by the EAG	84
3.7	Conclusions of the clinical effectiveness section	84
4	COST EFFECTIVENESS	86
4.1	EAG’s comment on company’s review of cost-effectiveness evidence	86
4.2	Summary of the company’s submitted economic evaluation	91
4.3	Critique of company’s submitted economic evaluation by the EAG	146
4.4	Exploratory analyses undertaken by the EAG: LGG	153
4.5	Exploratory analyses undertaken by the EAG: HGG	161
5	IMPACT ON THE ICER OF ADDITIONAL CLINICAL AND ECONOMIC ANALYSES UNDERTAKEN BY THE EAG	168
5.1	LGG	168
5.2	HGG	172
6	OVERALL CONCLUSIONS	179
7	REFERENCES	181
8	APPENDICES	185
	Appendix 1: How to change the company’s model to implement the EAG scenario analyses	185

LIST OF TABLES

Table 1: Overview of the EAG’s key issues	4
Table 2: The summary of the EAG’s preferred assumptions and resulting ICER in the LGG population	12
Table 3: The summary of the EAG’s preferred assumptions and resulting ICER in the HGG population who have previously received temozolomide treatment as a first line systemic therapy ...	13
Table 4: The summary of the EAG’s preferred assumptions and resulting ICER in the HGG population who did not receive temozolomide as a first line systemic therapy.....	14
Table 5: Clinical effectiveness evidence (reproduced from CS ² , page 32, Table 3).....	26
Table 6: Ongoing studies of dabrafenib with trametinib in paediatric gliomas (reproduced from CS ² , page 85, Table 37).....	32
Table 7: Quality assessment of LGG studies (CS ² , Appendix D, Table 11).....	34
Table 8: Demographics and baseline disease characteristics, FAS-LGG (reproduced from CS ² , page 44, Table 8).....	38
Table 9: Efficacy results for the TADPOLE LGG cohort using RANO criteria ^{26, 27} on full analysis set (reproduced from CS ² , Table 10, Table 11, Table 12, Table 13 and CS ² , Appendix N).....	44
Table 10: PROMIS Parent Proxy Global Health ³⁰ – Repeated measures analysis, FAS-LGG (reproduced from CS ² , Table 14).....	48
Table 11: Overview of AEs in LGG cohort (reproduced from CS ² , Document B, Table 28)	53
Table 12: Demographics and baseline disease characteristics, FAS-HGG (reproduced from CS ² , page 47, Table 9).....	56
Table 13: Efficacy results for the TADPOLE HGG cohort using RANO criteria ^{26, 27} on full analysis set (reproduced from CS ² , Table 15, Table 16, Table 17, Table 18 and Table 19).....	60
Table 14: Overview of AEs in HGG cohort (Reproduced from the CS ² , Document B, Table 33).....	63
Table 15: Summary of study design and characteristic of included in the ITC analyses (reproduced from CS ² , Appendix D, Table 13, Table 14, Table 15, Table 18 amended and Table 19)	67
Table 16: Baseline characteristics of studies included in ITCs (reproduced from CS ² , Appendix D, Table 16)	69
Table 17: Quality assessment of ITC studies (reproduced from Clarification response A8 ¹⁶)	72
Table 18: Summary of study design and characteristic of included in the MAIC analyses (reproduced from Clarification response A15 ¹⁶ , Table 3, Table 4, Table 5, Table 8 and Table 9 amended)	78
Table 19: Baseline characteristics of studies included in the BSC ITC analyses (Clarification response A15 ¹⁶ , Table 6).....	80
Table 20: Summary of OS and PFS ITC (no prior TMZ subgroup): D+T (TADPOLE) vs TMZ (Verschuur <i>et al.</i>) (adapted from CS Table 25 and Table 27).....	82
Table 21: Summary of OS and PFS MAIC: D+T (prior TMZ subgroup) (TADPOLE) vs cilengitide (MacDonald <i>et al.</i>) (adapted from clarification response ¹⁶ Table 12 and Table 13).....	83

Table 22:	Summary of OS MAIC: D+T (prior TMZ subgroup) (TADPOLE) vs bevacizumab (Narayana <i>et al.</i>) (adapted from clarification response ¹⁶ Table 15).....	83
Table 23:	The inclusion and exclusion criteria for the cost-effectiveness review (replicated from CS ² , Appendix G, Table 6)	88
Table 24:	The inclusion and exclusion criteria for the health related quality of life review (replicated from CS ² , Appendix H, Table 5).....	89
Table 25:	The inclusion and exclusion criteria for the cost and health care resource use review (replicated from CS ² , Appendix I, Table 6).....	90
Table 26:	The means and standard deviations used to sample patient characteristics (adapted from CS ² , Table 41).....	95
Table 27:	A summary of utility values used in the LGG population	104
Table 28:	LGG adverse effect incidence rates associated with treatment (modified from Table 44 in CS ²)	107
Table 29:	The regression formulae used to predict the dose of intervention (in mg) treatments in the company's economic model for low grade glioma patients receiving Dabrafenib and Trametinib ...	110
Table 30:	Dosage for the comparator treatments	111
Table 31:	List and NHS prices for the intervention and comparator drugs.....	112
Table 32:	Costs associated with the administration of investigated chemotherapy treatments...	112
Table 33:	The frequency and unit costs for monitoring visits and test costs, whilst on treatment up until 84 weeks post-treatment commencement (adapted from CS ² , Table 48 and 49, pages 130-131)	114
Table 34:	Treatments used at each LGG progression and their associated costs (replicated from CS ² , Table 50, page 132)	115
Table 35:	Costs associated with adverse events (modified from CS ² , Table 52, pages 134-135)	116
Table 36:	The means and standard deviations of the patient characteristics in the high grade glioma economic model (adapted from CS ² , Table 41, page 101).....	117
Table 37:	A summary of utility values used in the HGG population.....	122
Table 38:	HGG adverse effect incidence rates associated with treatment (modified from Table 44 in the CS ²)	124
Table 39:	The regression formulae used to predict the dose of intervention (in mg) treatments in the company's economic model for high grade glioma patients receiving Dabrafenib and Trametinib	125
Table 40:	Dosage for the comparator treatments	126
Table 41:	List and NHS prices for the comparator treatments.....	126
Table 42:	Breakdown of the four weekly palliative care cost for paediatric HGG patients modified from Table 51 in the CS ²)	126

Table 43:	Costs associated with adverse events (modified from CS ² , Table 52).....	127
Table 44:	The company’s discounted base case model results in the LGG cohort.....	132
Table 45:	The company’s discounted base case model results in the HGG cohort, TMZ naïve subgroup	135
Table 46:	The company’s discounted base case model results in the HGG cohort, TMZ experienced subgroup	138
Table 47:	Fit statistics of PFS extrapolation for PFS assessed by independent review in the LGG cohort (adapted from clarification response Appendix P)	154
Table 48:	PFS predictions using the candidate parametric models for C+V using independent review in the LGG cohort.	155
Table 49:	PFS predictions using the candidate parametric models for D+T using independent review in the LGG cohort.	156
Table 50:	Fit statistics of EFS extrapolation from Jakacki 2016 (adapted from clarification response Appendix P)	157
Table 51:	EFS predictions using the candidate parametric models extrapolated using the Jakacki 2016 data	158
Table 52:	Fit statistics of PPS extrapolation for D+T using independent review of the TMZ-pooled HGG cohort (adapted from clarification response Appendix P).....	159
Table 53:	PPS predictions using the candidate parametric models for D+T using independent review in the TMZ-pooled HGG cohort.	160
Table 54:	Fit statistics of PFS extrapolation for D+T using independent review, IPTW adjusted for the no prior TMZ subgroup (adapted from clarification response Appendix P).....	162
Table 55:	PFS predictions using the candidate parametric models for PFS D+T using independent review IPTW adjusted for the no prior TMZ subgroup	163
Table 56:	Fit statistics of PFS extrapolation for TMZ using independent review of the no prior TMZ, IPTW adjusted, subgroup in the HGG cohort. Adapted from Clarification Response Appendix P.	164
Table 57:	PFS predictions using the candidate parametric models for TMZ using independent review of the no prior TMZ, IPTW adjusted subgroup in the HGG cohort.....	164
Table 58:	Fit statistics of PFS extrapolation for D+T using independent review for the prior TMZ subgroup (adapted from clarification response Appendix P).....	166
Table 59:	PFS predictions using the candidate parametric models for D+T using independent review for the prior TMZ subgroup	167
Table 60:	The results of the EAG exploratory analyses that form part of the EAG’s base case, applying a 1.2 weight to accrued QALYs.....	169
Table 61:	The full results of the EAG’s discounted base case model results in the LGG cohort	170

Table 62:	Results of changing the distribution for post-progression survival after developing a progressed malignantly transformed tumour in the LGG population	170
Table 63:	Scenario analysis of adding in a proportion of wastage of the bottles of trametinib	171
Table 64:	Results enforcing the stopping of D+T treatment at 100 years.....	171
Table 65:	Results of changing the distributions for PFS back to the company's preferred assumptions	172
Table 66:	The results of the EAG exploratory analyses that form part of the EAG's base case in the HGG population who are TMZ experienced, applying a 1.7 weight to accrued QALYs.....	173
Table 67:	The EAG's discounted base case model results in the HGG cohort who are TMZ experienced	173
Table 68:	Results of changing the distribution for post-progression survival after developing a progressed malignantly transformed tumour in the HGG population who have previously had TMZ	174
Table 69:	Scenario analysis of adding in a proportion of wastage of the bottles of trametinib in the HGG population who have previously received TMZ.....	174
Table 70:	Results of the scenario analyses where the post progression survival is changed in the control arm compared to D+T.....	175
Table 71:	The results of the scenario where D+T can be given for up to 100 years.....	175
Table 72:	The results of the scenarios modelling PFS	176
Table 73:	The results of the EAG exploratory analyses that form part of the EAG's base case, applying a 1.7 weight to accrued QALYs.....	176
Table 74:	The detailed results of the EAG's preferred base case ICER in the HGG population who are TMZ naïve.....	177
Table 75:	Results of changing the distribution for post-progression survival after developing a progressed malignantly transformed tumour in the HGG population who have not previously had TMZ	177
Table 76:	Scenario analysis of adding in a proportion of wastage of the bottles of trametinib in the HGG population who have not previously received TMZ.....	178
Table 77:	Results of the scenario analyses where the post progression survival is changed in the control arm compared to D+T (HGG TMZ naïve).....	178
Table 78:	The results of the scenario where D+T can be given for up to 100 years.....	179
Table 79:	The results of the scenario analysis in which the company's preferred assumptions on PFS are run through the EAG's base case model	179

LIST OF FIGURES

Figure 1: The treatment pathway for paediatric patients with low grade glioma who are found to have a BRAF V600E mutation via genetic testing.....	17
Figure 2: The treatment pathway for paediatric patients with high grade glioma who are found to have a BRAF V600E mutation via genetic testing	19
Figure 3: Schematic of the model for LGG patients.....	93
Figure 4: Schematic of the model for HGG patients (adapted from CS, Figure 18, page 92).....	95
Figure 5: Distribution of age for patients with low grade glioma	95
Figure 6: Survival extrapolation included in company’s base case analysis, PFS LGG for the D+T and C+V arm (reproduced from CS ² Figure 22).....	97
Figure 7: Survival extrapolation included in company’s base case analysis, EFS following malignant transformation, Jakacki 2016 (reproduced from CS ² Figure 33)	99
Figure 8: Time to death from all causes used in the company’s model (replicated from CS ² , Figure 32)	100
Figure 9: Survival probabilities for early (<18 month) and late progressors (\geq 18 months) used in the economic analysis, LGG (CS, Figure 25, page 109).....	100
Figure 10: Survival extrapolation included in company’s base case analysis, time to Glioma specific death (post-progression after malignant transformation), HGG, investigator assessed (reproduced from CS ² Figure 27)	101
Figure 11: Survival extrapolation, TTD LGG for D+T (reproduced from CS ² Appendix P)	103
Figure 12: The distribution of age for patients in the high-grade glioma economic model	118
Figure 13: Survival extrapolation included in company’s base case analysis, PFS HGG for D+T for the prior TMZ and no prior TMZ subgroups, as per investigator assessment (reproduced from CS Figure 24)	119
Figure 14: Survival extrapolation, TTD HGG for D+T (reproduced from CS Appendix P)	121
Figure 15: Comparison of the time to event functions for progression free survival in low grade glioma patients receiving dabrafenib and trametinib to survivor functions, with both the time to event functions and the survivor functions using a piecewise Kaplan-Meier function followed by a log normal parametric extrapolation.	130
Figure 16: The cost-effectiveness acceptability curve in the LGG population, after applying a disease severity modifier of 1.2	133
Figure 17: The cost-effectiveness acceptability curve in the LGG population, after applying a disease severity modifier of 1.2	133
Figure 18: The cost-effectiveness plane in the HGG population who are TMZ naïve, after applying a disease severity modifier of 1.7.....	136

Figure 19:	The cost-effectiveness acceptability curve in the HGG population who are TMZ naïve, after applying a disease severity modifier of 1.7	136
Figure 20:	The cost-effectiveness plane in the HGG population who are TMZ experienced, after applying a disease severity modifier of 1.7.....	139
Figure 21:	The cost-effectiveness acceptability curve in the HGG population who are TMZ experienced, after applying a disease severity modifier of 1.7	139
Figure 22:	The tornado plot showing how sensitive the company’s model is to the changes in some key parameters using a disease severity modifier of 1.2 (replicated from CS, Figure 38, page 152).	140
Figure 23:	The scenarios selected by the company to present in a tornado plot (replicated from CS, Figure 38, page 152).	141
Figure 24:	The tornado plot showing how sensitive the company’s model is to the changes in some key parameters using a disease severity modifier of 1.2 (replicated from CS ² , Figure 38, page 152)	142
Figure 25:	The scenarios selected by the company to present in a tornado plot (replicated from CS, Figure 39, page 153).	143
Figure 26:	The tornado plot showing how sensitive the company’s model is to the changes in some key parameters using a disease severity modifier of 1.2 (replicated from CS ² , Figure 38, page 152)	144
Figure 27:	The scenarios selected by the company in their analyses in the HGG population who are TMZ experienced presented in a tornado plot (replicated from CS ² , Figure 39, page 153).	145
Figure 28:	Independently fitted candidate parametric models for PFS for C+V using independent review in the LGG cohort (adapted from clarification response Appendix P)	155
Figure 29:	Independently fitted candidate parametric models for PFS for D+T using independent review in the LGG cohort (adapted from clarification response Appendix P).	156
Figure 30	Independently fitted candidate parametric models for EFS data from Jakacki <i>et al.</i> 2016. Adapted from Clarification Response Appendix P.....	158
Figure 31	Independently fitted candidate parametric models for PPS for TMZ-pooled HGG cohort, according to independent review. Adapted from Clarification Response Appendix P.....	160
Figure 32	Independently fitted candidate parametric models for PFS D+T using independent review of the no prior TMZ, IPTW (MAIC) adjusted subgroup in the HGG cohort. Adapted from Clarification Response Appendix P.	162
Figure 33	Independently fitted candidate parametric models for PFS for TMZ using independent review, IPTW adjusted for the no prior TMZ subgroup (adapted from clarification response Appendix P)	164
Figure 34	Independently fitted candidate parametric models for PFS for D+T using independent review for the prior TMZ subgroup (adapted from clarification response Appendix P)	166

Confidential until published

LIST OF BOXES

Box 1: Summary of the main issues identified within the company's health economic model 152

ABBREVIATIONS

Adverse events	AEs
AF	Acceleration Factor
AFT	Accelerated Failure Time
AIC	Akaike Information Criterion
ASCO	American Society of Clinical Oncology
ASCO GI	The American Society of Clinical Oncology Gastrointestinal Cancers Symposium
AWMSG	All Wales Medicines Strategy Group
BIC	Bayesian Information Criterion
BSA	Body Surface Area
BSC	Best Supportive Care
CEAC	Cost-Effectiveness Acceptability Curve
CS	Company Submission
CT	Computed Tomography
DSU	Decision Support Unit
eMIT	electronic Market Information Tool
EORTC QLQ-C30	European Organisation for Research and Treatment of Cancer Quality-of-Life Questionnaire Core 30
EQ-5D-3L	EuroQol 5 dimensions 3 level
EAG	Evidence Review Group
ESMO	European Society of Medical Oncology
GEE	Generalised Estimating Equation
GEJ	Gastro-Oesophageal Junction Cancer
HAS	Haute Autorité de Santé
HER2	Human Epidermal Growth Factor Receptor 2
HERC	Health Economics Research Centre
HR	Hazard Ratio
HRQoL	Health-Related Quality of Life
HTAD	Health Technology Assessment Database
ICER	Incremental Cost Effectiveness Ratio
ISPOR	International Society for Pharmacoeconomics and Outcomes Research
KM	Kaplan-Meier
mGC	metastatic Gastric Cancer
MRU	Medical Resource Use
NHS EED	National Health Service Economic Evaluation Database

NICE	National Institute for Health and Care Excellence
NR	Not Reported
ORR	Overall Response Rate
OS	Overall Survival
PAS	Patient Access Scheme
PD	Progressed Disease
PF	Progression-Free
PFS	Progression-Free Survival
PH	Proportional Hazards
PSM	Partitioned Survival Model
PSSRU	Personal Social Services Research Unit
QALY	Quality-Adjusted Life Year
QIC	Quasi-likelihood under Independence Model Criterion
RCT	Randomised Controlled Trial
ROW	Rest Of World
SACT	Systematic Anti-Cancer Treatment
SLR	Systematic Literature Review
SLV	Statens Legemiddelverk
SMC	Scottish Medicines Consortium
STA	Single Technology Appraisal
TSD	Technical Support Document
TTD	Time To Treatment Discontinuation

1 EXECUTIVE SUMMARY

This summary provides a brief overview of the key issues identified by the evidence review group (EAG) as being potentially important for decision making. It also includes the EAG's preferred assumptions and the resulting incremental cost-effectiveness ratios (ICERs).

Section 1.1 provides an overview of the key issues. Section 1.2 provides an overview of key model outcomes and the modelling assumptions that have the greatest effect on the ICER. Sections 1.3 to 1.6 explain the key issues in more detail. Background information on the condition, technology and evidence and information on non-key issues are in the main EAG report.

All issues identified represent the EAG's view, not the opinion of NICE.

1.1 Overview of the EAG's key issues

Table 1: Overview of the EAG's key issues

ID5104	Summary of issue	Report sections
Decision Problem		
Population	The EAG considers that LGG and HGG are distinct populations, as the expected outcomes and treatments for these two groups are very different.	2.3.1
Comparators	In the LGG population, there is at least one missing comparator in vinblastine alone as chemotherapy. Chemotherapy regimens other than the carboplatin and vincristine were explicitly required in the scope.	2.3.3.1
Position of D+T in LGG	The scope has D+T positioned as a systemic therapy for LGG. The clinical evidence only relates to D+T as a first line therapy.	2.3.2
Clinical		
Study sample size	The two studies (RCT in the LGG population, and a prospective cohort study in the HGG population) were small in sample size. This means that some caution should be taken in interpreting the results.	3.7.2
Issues in the indirect comparisons	The comparator studies used in the indirect treatment comparisons in the HGG population were old and of poor quality. A particular concern was that the comparator studies used molecularly unselected patients (i.e., patients with all types of HGG tumours, not just patients with BRAF V600E mutations). This means that there may be some populations differences between the studies used in the indirect comparisons. The EAG expects that patients with BRAF V600E mutations would have worse outcomes than patients without BRAF V600E mutations. So, this may lead to an underestimation of the relative treatment effect of D+T.	3.7.3
Duration of treatment	The median duration of treatment with dabrafenib or trametinib is limited to at most 140 weeks in the clinical study.	3.7.2
Cost-effectiveness		
Assumptions around progression	The model used for the LGG population is particularly sensitive to the source of progression-free survival (PFS) data (investigator assessment vs. independent review). Due to the inflexibility of the company's model, either investigator assessed PFS is used to inform both efficacy and treatment discontinuation (company's base case) or independent review assessed PFS is used (EAG's base case).	4.3.2.1, 4.3.3.1
Utility estimation	The company has sourced all utility values from studies in adults with glioma.	4.3.1.3
Duration of treatment	The company's model implements stopping rules at 3.71 years in the LGG population and 12.5 years in the HGG population. These stopping rules based on treatment duration are not in the draft SmPC	4.3.1.2

EAG, evidence assessment group; LGG, low grade glioma; HGG, high grade glioma; BRAF V600E; RCT, randomised controlled trial; ICER, incremental cost-effectiveness ratio; SmPC, summary of product characteristics

The key differences between the company's preferred assumptions and the EAG's preferred assumptions are around the modelling of progression-free survival.

1.2 Overview of key model outcomes

NICE technology appraisals compare how much a new technology improves length (overall survival) and quality of life in a quality-adjusted life year (QALY). An ICER is the ratio of the extra cost for every QALY gained.

Overall, the technology is modelled to affect QALYs by:

- Increasing progression-free survival
- Marginally changing utility at the start of the model in the two arms, due to the expected differences in adverse events

Overall, the technology is modelled to affect costs by:

- Increasing costs of treatment itself
- Decreasing costs associated with drug administration and hospital acquisition costs
- Different monitoring costs for patients treated
- Marginally changing costs associated with adverse events.

1.2.1 LGG

The modelling assumptions that have the greatest effect on the ICER are:

- The choice of how to model progression-free survival, including the definition of progression and selection of parametric statistical models fitted to the data
- The time spent by patients on D+T treatment

1.2.2 HGG

1.2.2.1 Prior TMZ subgroup

The modelling assumptions that have the greatest effect on the ICER are:

- The choice of how to model progression-free survival, including the definition of progression and selection of parametric statistical models fitted to the data
- Increasing the time spent by patients on BSC in the post-progression survival health state
- The time spent by patients on D+T treatment

1.2.2.2 *No prior TMZ subgroup*

The modelling assumptions that have the greatest effect on the ICER are:

- Increasing the time spent by patients on BSC in the post-progression survival health state
- The time spent by patients on D+T treatment

1.3 The decision problem: summary of the EAG’s key issues

Issue 1: The populations included in the appraisal

Report section	Section 2.3.1
Description of issue and why the EAG has identified it as important	The EAG believes that there are two distinct populations in this appraisal (LGG and HGG), not one population with two subgroups as specified in the scope.
What alternative approach has the EAG suggested?	The EAG believes that the committee should consider the two populations separately in their deliberations. This does mean that the same evidence or assumptions may be viewed favourably in one population but not the other.
What is the expected effect on the cost-effectiveness estimates?	Minimal effect. There will only be impact on the ICERs if the committee have different preferred assumptions in the two populations.
What additional evidence or analyses might help to resolve this key issue?	No additional evidence is required.

EAG, evidence assessment group; LGG, low grade glioma; HGG, high grade glioma; ICERs, incremental cost-effectiveness ratios

Issue 2: Missing comparator in the LGG population

Report section	Section 2.3.3.1
Description of issue and why the EAG has identified it as important	The EAG believes there is a missing comparator in the LGG population. Our clinical advisors stated that vinblastine alone would be considered as a chemotherapy for 1 st line systemic therapy in the LGG population, as this is used interchangeably with carboplatin and vincristine in their clinical practice. The use of carboplatin and vincristine alone in the company submission is against the final scope that specifically requests that chemotherapies other than carboplatin plus vincristine are considered.
What alternative approach has the EAG suggested?	None
What is the expected effect on the cost-effectiveness estimates?	Unknown, but as the regimens are both used, they are likely to have similar effectiveness at a similar cost. Therefore, it is likely that any changes to ICERs would be small, but this cannot be guaranteed.
What additional evidence or analyses might help to resolve this key issue?	As far as the EAG is aware, there is no randomised controlled trial of carboplatin+vincristine versus vinblastine. If this is the case, the only alternative approach would be to elicit this relative effectiveness on progression-free survival and other key outcomes.

EAG, evidence assessment group; LGG, low grade glioma

Issue 3: In the LGG population, the evidence for dabrafenib and trametinib is limited to use as a first line systemic therapy

Report section	Section 2.3.1
Description of issue and why the EAG has identified it as important	The final scope specified that dabrafenib and trametinib is being considered as a systemic therapy in the LGG population, however the key inclusion criteria in TADPOLE for the LGG population was that they were eligible to receive their first systemic therapy. Therefore, no evidence has been presented on the use of dabrafenib and trametinib as a 2 nd or later line systemic therapy.
What alternative approach has the EAG suggested?	None, the EAG does not believe an alternative approach is possible with the current evidence base.
What is the expected effect on the cost-effectiveness estimates?	Unknown, it will all depend on how effective dabrafenib and trametinib is in later chemotherapy lines.
What additional evidence or analyses might help to resolve this key issue?	Estimates of the effectiveness of dabrafenib and trametinib in later therapy lines should be provided to allow assessment of effectiveness and cost-effectiveness when used within the full scope (which is just as a systemic therapy).

EAG, evidence assessment group; LGG, low grade glioma

1.4 The clinical effectiveness evidence: summary of the EAG’s key issues

Issue 4: Small population size

Report section	Section 3.7
Description of issue and why the EAG has identified it as important	Small population size in the TADPOLE study.
What alternative approach has the EAG suggested?	No alternative approach to analyse the available evidence was possible. It is expected there would be small population sizes, as BRAF V600E mutation-positive Glioma is a rare cancer in children.
What is the expected effect on the cost-effectiveness estimates?	Unknown. It is unknown in what direction further data collection would move the cost-effectiveness (if at all), but it should make the estimates more certain. Further evidence would make the effect sizes in the RCT more certain and potentially reduce uncertainty in the indirect comparison making it more robust.
What additional evidence or analyses might help to resolve this key issue?	Further follow up data as well as additional studies, if ethical.

EAG, evidence assessment group; RCT, randomised controlled trial

Issue 5: Use of a prospective cohort study and indirect treatment comparison methods to estimate effects in the HGG population

Report section	Section 3.7
Description of issue and why the EAG has identified it as important	Use of a prospective cohort study in the HGG population and the consequent use of indirect comparison methods in the HGG population to obtain relative treatment effects for dabrafenib+trametinib. There may be generalisability issues with the chosen comparator studies, as they are over 20 years old. There were also a limited number of covariates used in the adjustment.
What alternative approach has the EAG suggested?	No alternative approach is suggested by the EAG with the current evidence base. The existing studies for the comparators are old and have limited covariates available to conduct a more robust analysis. Furthermore, observation analyses, no matter how well statistically controlled, have the risk that unobservable bias has influenced the results.
What is the expected effect on the cost-effectiveness estimates?	Unknown. As a prospective cohort study was conducted in the HGG population, this means an indirect comparison was used to estimate the relative treatment effect. Even with the best indirect comparisons there is still the potential for bias in the estimates of effect. This can be in favour of or against the intervention treatment.
What additional evidence or analyses might help to resolve this key issue?	Robust modern cohort studies of current treatments in HGG patients would help resolve some of the EAG's concerns with the quality of the indirect comparisons. This would reduce the risk of bias in the estimates of the relative effectiveness of dabrafenib+trametinib in the HGG population.

HGG, high grade glioma; RCT, randomised controlled trial; EAG, Evidence Assessment Group

1.5 The cost-effectiveness evidence: summary of the EAG’s key issues

Issue 6: Choice of data assumptions for progression in the company submission

Report section	Section 4.2.5 and 4.3
Description of issue and why the EAG has identified it as important	<p>The company chose to use investigator assessed PFS to inform both efficacy and treatment discontinuation due to progression. To extrapolate PFS data a piecewise hybrid approach using Kaplan-Meier data followed by a parametric model at a fixed time point was adopted by the company. In the LGG population, the same rate of progression was assumed for both arms after the period in which the KM data were used. In the HGG population, a constant hazard ratio was applied.</p> <p>The EAG notes that (i) investigator assessed PFS is not used routinely in practice to determine progression; (ii) the hybrid extrapolation approach is highly arbitrary; (iii) the assumption of same rate of progression in the LGG population and a constant hazard ratio for lifetime in the HGG population have not been justified by the company.</p>
What alternative approach has the EAG suggested?	<p>The EAG prefers to use independent review assessed PFS for efficacy and investigator assessed PFS for treatment discontinuation due to progression. However, due to the inflexibility of the company’s model, the same PFS has to be used for efficacy and treatment discontinuation. The EAG’s base case used independent review assessed PFS. The EAG also prefers to use independently fitted parametric models for the entire time horizon of the economic model. For the HGG population who had not received temozolomide before the EAG prefers to use the IPTW adjusted data.</p>
What is the expected effect on the cost-effectiveness estimates?	<p>Moving from the company’s preferred set of assumptions to the EAG’s preferred set of assumptions only had a large effect on the ICER in the LGG population. The ICERs were similar to the company’s in the HGG populations. In the LGG population, the EAG’s ICER was lower than the company’s ICER.</p>
What additional evidence or analyses might help to resolve this key issue?	

EAG, evidence assessment group; LGG, low grade glioma; HGG, high grade glioma; ICERs, incremental cost-effectiveness ratios

Issue 7: Use of adult utilities in children

Report section	Section 4.2.5 and 4.3
Description of issue and why the EAG has identified it as important	All studies used by the company to obtain utility estimates were conducted in an adult population. These utility changes were then applied in a population who are all children.
What alternative approach has the EAG suggested?	The EAG did attempt to obtain utility reductions from our clinical experts. Based on their responses, the EAG believed that our clinicians had been anchored on the examples given and so a scenario analysis was not conducted using the EAG clinician values.
What is the expected effect on the cost-effectiveness estimates?	Unknown, if the current utility values are invalid for children, then sensitivity analyses using current utility values are of minimal use in informing how sensitive the ICER will be.
What additional evidence or analyses might help to resolve this key issue?	Additional evidence on the utilities in children using other techniques such as vignettes, could be considered.

EAG, evidence assessment group; LGG, low grade glioma; HGG, high grade glioma; ICERs, incremental cost-effectiveness ratios

Issue 8: Treatment duration

Report section	4.3.1.2
Description of issue and why the EAG has identified it as important	The treatment duration of dabrafenib and trametinib is unspecified in the draft SmPC that was available to the EAG at the time of writing this report. The company assume in their base case analyses that patients would stop treatment at 3.71 years in the LGG population and 12.5 years in the HGG population. Furthermore, patients in the D+T arm of the TADPOLE study spent at most, 140 weeks on treatment.
What alternative approach has the EAG suggested?	Modelling time on treatment reliably is difficult without more data or information from the final SmPC. The EAG has done what we believe to be an extreme scenario where patients in the model can only stop treatment due to progression or discontinuation for other reasons.
What is the expected effect on the cost-effectiveness estimates?	If the stopping rules implemented by the company are completely removed, the ICERs increase. The EAG believes that the increase is potentially significant.
What additional evidence or analyses might help to resolve this key issue?	The final SmPC would be useful if it specified anything about treatment discontinuation after a certain time on treatment. Long term follow-up and monitoring of discontinuation whilst on dabrafenib and trametinib of the patients recruited into the TADPOLE study would be useful if the final SmPC matches the draft SmPC.

D+T, dabrafenib + trametinib; EAG, evidence assessment group; LGG, low grade glioma; HGG, high grade glioma; SmPC, summary of product characteristics

1.6 Other key issues: summary of the EAG's view

No other key issues were identified by the EAG.

1.7 Summary of EAG's preferred assumptions and resulting ICER

1.7.1 LGG

Table 2: The summary of the EAG's preferred assumptions and resulting ICER in the LGG population

Scenario	Incremental QALYs	Incremental cost	ICER (change from company base case)
Company's base case	████	████	£25,776
Scenario 1: Change PFS to EAG's base case: independent assessment of disease progression; independent curve fitting; extrapolation for whole time period; Gompertz distribution for D+T, log normal of C+V	████	████	£13,111
Scenario 2: Change distribution for time to progressed malignant transformation to a two-knot odds spline model	████	████	£25,773
Scenario 3: Change distribution for time to death after developing a progressed malignant transformation to log-logistic	████	████	£25,769
Scenario 4: Change the progressed malignant transformation utility decrement to 0.5% per week	████	████	£25,760
Scenario 5: Use Hernandez <i>et al.</i> ¹ to calculate the utility decrement for having LGG	████	████	£26,734
Scenario 6: Implement Wastage for comparator treatments	████	████	£25,557
EAG preferred base case: 1+2+3+4+5+6	████	████	£13,604

QALYs, quality adjusted life years; ICER, incremental cost-effectiveness ratio; PFS, progression free survival; D+T, dabrafenib and trametinib; C+V, carboplatin and vincristine; LGG, low grade glioma; EAG, evidence assessment group

1.7.2 HGG

1.7.2.1 Prior TMZ subgroup

Table 3: The summary of the EAG’s preferred assumptions and resulting ICER in the HGG population who have previously received temozolomide treatment as a first line systemic therapy

	Incremental QALYs	Incremental costs	ICER
Company’s base case	████	██████	£29,214
Scenario 1: PFS, independent review, log normal parametric model, extrapolation the entire period	████	██████	£21,568
Scenario 2: Change distribution for time to death after developing a progressed malignant transformation to log normal	████	██████	£29,044
Scenario 3: Change the progressed HGG utility decrement to 0.5% per week	████	██████	£29,422
EAG base case: 1+2+3	████	██████	£21,512

QALYs, quality adjusted life years; ICER, incremental cost-effectiveness ratio; HGG, high grade glioma; EAG, evidence assessment group

1.7.2.2 No prior TMZ subgroup

Table 4: The summary of the EAG’s preferred assumptions and resulting ICER in the HGG population who did not receive temozolomide as a first line systemic therapy

	Incremental QALYs	Incremental costs	ICER
Company’s base case	████	██████	£28,785
Scenario 1: PFS, independent review, IPTW adjusted, extrapolation for the entire period, D+T uses log normal distribution, C+V uses log logistic distribution	████	██████	£27,419
Scenario 2: Change distribution for time to death after developing a progressed malignant transformation to log-logistic	████	██████	£28,665
Scenario 3: Change the progressed HGG utility decrement to 0.5% per week	████	██████	£28,945
EAG base case: 1+2+3	████	██████	£27,500

QALYs, quality adjusted life years; ICER, incremental cost-effectiveness ratio; PFS, progression free survival; IPTW, inverse of probability of treatment weighting; D+T, dabrafenib and trametinib; C+V, carboplatin and vincristine; HGG, high grade glioma; EAG, evidence assessment group

2 BACKGROUND

The report provides a review of the evidence submitted by the company (Novartis) in support of the use of dabrafenib and trametinib (D+T) in patients aged 1-17 with glioma. This covers two related, but different conditions Low Grade Glioma (LGG) and High Grade Glioma (HGG), with the prognosis and treatment lines being different in the two conditions. D+T was positioned as the first systemic treatment for patients with LGG, but was positioned as the second systemic treatment (after relapse or progression post first systemic treatment) for patients with HGG. It considers both parts of the company submission (CS) which consists of their documents and executable model received by the Evidence Assessment Group (EAG) on the 13th October 2023, a revised set of company submission documents received by the EAG on the 1st November 2023, it's clarification responses which were received by the EAG on the 20th November 2023 and it's response to an additional clarification question by the EAG, including a revised executable model on the 30th November 2023.

2.1 Critique of company's description of underlying health problem

The EAG considered the company's description of the underlying health problem to be adequate.² The company's description of the underlying health problem is briefly described in this section.

In brief, gliomas originate in the glial cells, which are the supporting cells in the brain and spinal cord.³ An analysis of US registry data from 2008 to 2012 found that gliomas accounted for 47% of all brain and central nervous system (CNS) tumours in children and adolescents aged 0-19.⁴ Brain and CNS tumours are the leading cause of cancer deaths in children in the UK.⁵ Paediatric gliomas are classified by the World Health Organization (WHO) to be either LGG (Grade 1 or 2) or HGG (Grade 3 or 4). LGG is more common than HGG, with 150 children developing LGG per year in the UK and fewer than 30 children per year developing HGG per year in the UK.^{6, 7}

BRAF mutations can lead to failures in the in the signalling pathway to cells, which lead to cell proliferation and tumorigenesis. BRAF V600E mutations are the most common mutation in paediatric gliomas. A systematic review of the prevalence of BRAF V600E mutations, of which BRAF V600E is the most common mutation type, BRAF V600 mutations occur in 7% (95% Confidence Interval (CI), 4% to 10%) of all paediatric gliomas.⁸

Patients with HGG have 5-year overall survival rates of under 10%, if they have a Grade 4 glioma.^{9, 10} The company states there are no data on how the expected 5-year overall survival rate differs between paediatric patients with and without BRAF V600E mutation who have failed their first systemic treatment. Patients with LGG have better outcomes, with 5-year survival rates of 95% for patients with Grade 1 LGG. Patients with LGG and BRAF V600E mutations have been found to have poorer

outcomes after treatment with therapies that do not target this mutation, and an increased risk of transformation to HGG.^{9, 10}

2.2 Critique of company's overview of current service provision

The EAG considered the company's description of current service provision to be adequate.² The current service provision differs substantially by LGG and HGG, so these are dealt with separately here. Guidelines are not specific to paediatric tumours or to people with BRAF V600E mutations.

2.2.1 *Low Grade Glioma*

The EAG's understanding of the treatment pathway is given in Figure 1. All patients get surgery, at the very least a sample is taken so that their glioma can be graded and genetically tested (including tests for BRAF V600E mutations), even if the tumour cannot be resected. If a complete resection is viable then most patients enter an observation period post-resection and if the complete resection is successful they are considered to no longer have glioma and exit the treatment pathways. If a tumour recurs in these patients, then it is treated as a new tumour. If a complete resection is not viable, then most patients enter a period of observation prior with systemic therapy being considered after the patient has a disease progression. However, for some patients it will be decided by the multidisciplinary team (MDT) to move them straight to systemic therapy rather than waiting for a progression to occur. Once patients who did not get a complete resection with their surgery experience a first disease progression, 1st line systemic therapy is considered for use, which consists of chemotherapy (particularly carboplatin + vincristine (C+V) or vincristine alone) and/or radiotherapy.

D+T is positioned against first line systemic in the TADPOLE LGG RCT (see Section 3.2.2), however the scope is slightly broader than this and has D+T positioned against systemic therapies without specifying the therapy line.^{11, 12} If the patient has another disease progression(s), a variety of treatments are considered, with radiotherapy, surgery and chemotherapy (with different regimens at each therapy line) all considered for use. Other V600E and Pan-RAF inhibitors, have some use in patients with LGG under compassionate use criteria. If a patient's LGG tumour malignantly transforms to a HGG tumour, then the patient will enter the HGG treatment pathways.

Figure 1: The treatment pathway for paediatric patients with low grade glioma who are found to have a BRAF V600E mutation via genetic testing

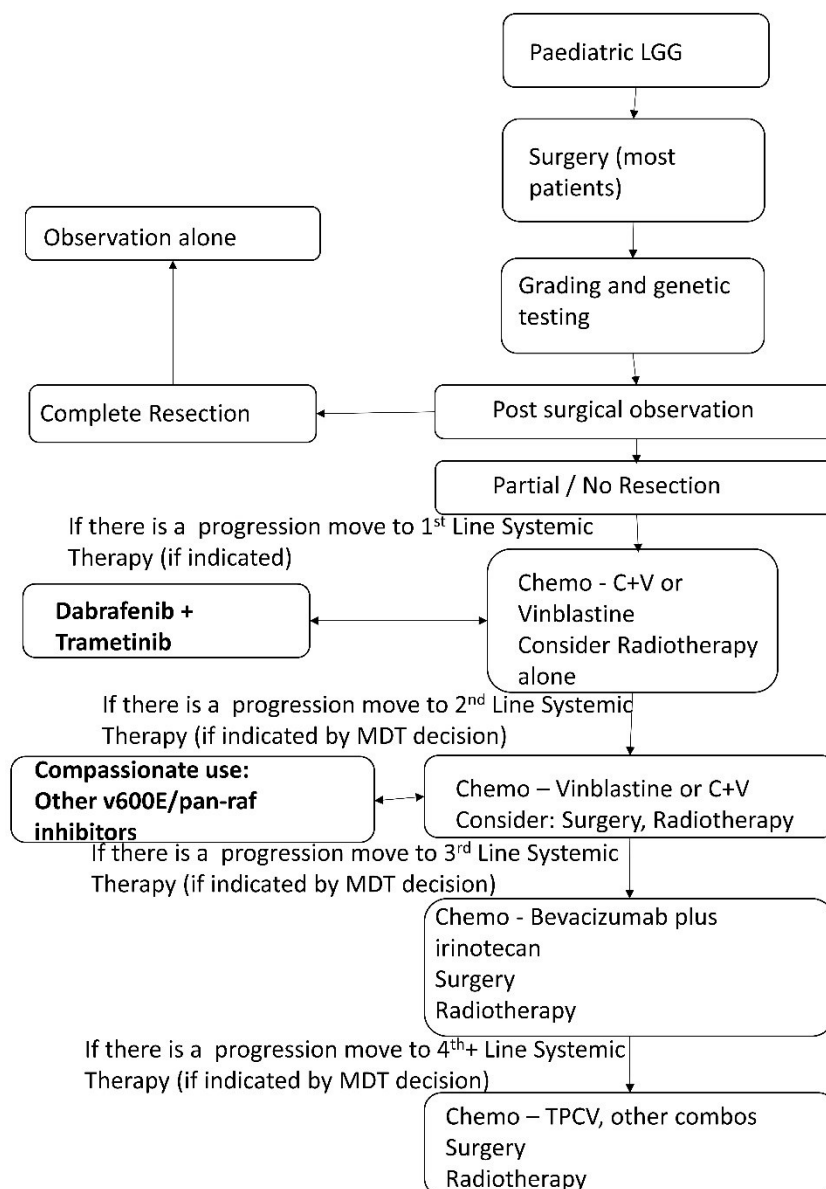

Abbreviations: LGG, low grade glioma; MDT, multidisciplinary team; C+V, carboplatin + vincristine; TPCV, tioguanine + procarbazine + lomustine + vincristine

2.2.2 High Grade Glioma

The pathway for HGG is given in Figure 2. The initial diagnosis, grading and surgery phases are the same for patients with HGG as it is for patients with LGG. However, the key difference is that patients with HGG typically receive adjuvant chemotherapy, which is usually temozolomide and lomustine (TMZ+CCNU), immediately after their surgeries rather than waiting for a progression of their glioma. When patients with HGG have a progression, their treatment options are limited with most patients receiving best supportive care (BSC). However, re-irradiation and chemotherapy are also considered in this therapy line as well.

It is in this therapy line that D+T is positioned to give these patients a further treatment option. The EAG's clinical experts noted that the current options for first line treatment are very limited, and they believed that D+T may be used as a 1st line therapy in HGG patients. The EAG notes that this would likely be an off label use of D+T, as it is outside of the final scope¹² and that there is no evidence from the key clinical studies to support this use. It should be noted that final licence from the Medicines and Healthcare products Regulatory Agency (MHRA) was not available to the EAG at the time of writing this report. The draft summary of product characteristics (SmPC) would preclude this use of the therapy as a 1st line treatment for HGG patients at this time, as the draft SmPC explicitly states that for HGG patients "*Finlee in combination with trametinib is indicated for the treatment of paediatric patients aged 1 year and older with high-grade glioma (HGG) with a BRAF V600E mutation who have received at least one prior radiation and/or chemotherapy treatment*".¹³ It should be noted that Finlee is the brand name for Dabrafenib.

One study is currently recruiting patients in this population (see Table 6 in Section 3.2), so this may change in subsequent appraisals.

Figure 2: The treatment pathway for paediatric patients with high grade glioma who are found to have a BRAF V600E mutation via genetic testing

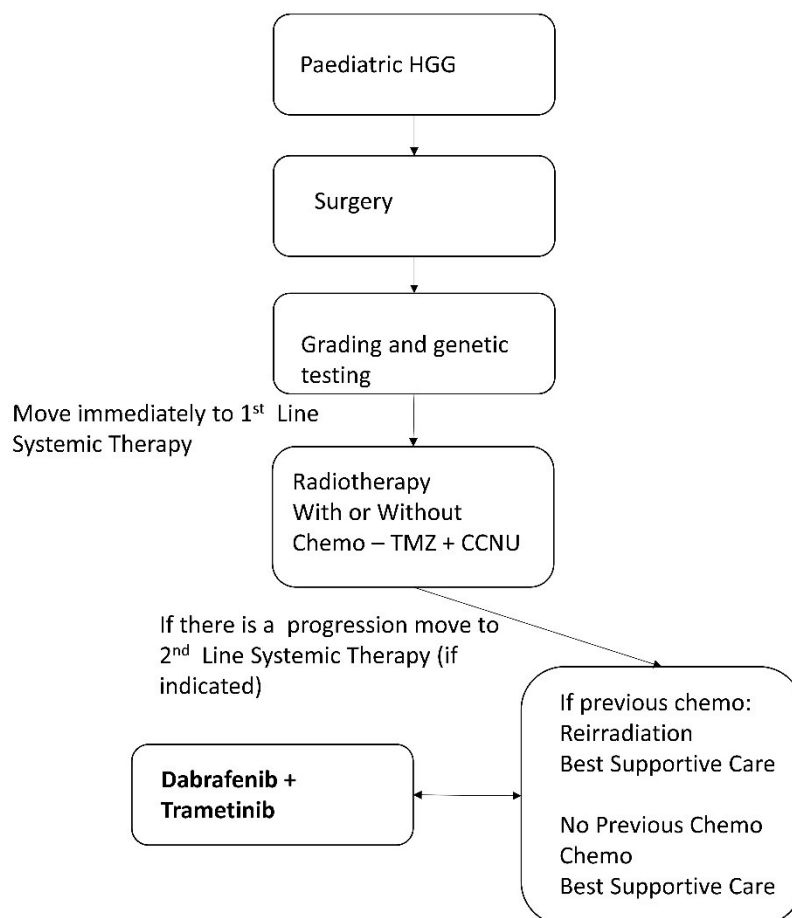

Abbreviations: HGG, high grade glioma, TMZ+CCNU, temozolomide and lomustine; chemo, chemotherapy

2.3 Critique of company’s definition of the decision problem

2.3.1 Population

The population referred to in the final scope is “*Children and young people with BRAF V600E mutation-positive glioma*” with subgroups of “*Low-grade glioma that requires systemic treatment*” and “*high-grade glioma that has relapsed, progressed or failed to respond to previous systemic treatment*”.¹²

The EAG believes that the CS had two separate populations rather than one population with subgroup analyses, these are:

- 1) Children and young people (aged 1-17) with BRAF V600E mutation-positive glioma who have LGG that requires first line systemic treatment (LGG population)

And

- 2) Children and young people (aged 1-17) with BRAF V600E mutation-positive glioma HGG that has relapsed, progressed or failed to respond to previous systemic treatment (HGG population)

This is for two key reasons. Firstly, the TADPOLE study consists of two separate parts, that are only unified by a participant recruitment strategy, ethical approval and funding source. The first part is a randomised controlled trial in the LGG population (TADPOLE LGG RCT). The second part is a prospective cohort study in the HGG population (TADPOLE HGG prospective cohort study). Secondly, as mentioned in the background (see Section 2.2), the treatments and disease course are very different in the LGG and HGG populations which results in a very different structure of the economic models submitted by the company. Thirdly, the position of D+T in the treatment pathways was different and this matched the populations recruited into the two parts of the TADPOLE study. The TADPOLE LGG RCT was only in patients who required first line systemic therapy, whereas the TADPOLE HGG prospective cohort study was only in patients who were relapsed or refractory to first line systemic therapy.¹⁴

Whilst this is different to the scope as written, as having two distinct populations is different to having one population with two subgroups, NICE believes that this is compliant with the final scope due to the differences in comparator treatments described in the final scope.

Another important thing to consider is that the population submitted to this appraisal is narrower than the scope. This is because, the TADPOLE LGG RCT had an inclusion criteria that limited the use of D+T to patients with LGG who had a “*necessity to begin first systemic treatment*”.¹⁴ The scope is less precise, as it does not specify which therapy line D+T is positioned in.¹²

2.3.2 Intervention

The intervention referred to in the final scope is “*Dabrafenib with trametinib*”.¹² The EAG believes that the CS is in line with the scope.

2.3.3 Comparators

2.3.3.1 LGG

The comparator used in the company’s model is the chemotherapy regimen of carboplatin plus vincristine (C+V).

The EAG believes that the company’s choice of LGG comparator is a deviation from the NICE scope, as other chemotherapy regimens have not been considered as potential first line options for systemic therapy in the paediatric LGG population.¹² This is explicitly required in the final scope.¹² Our clinical advisors believe C+V or vincristine alone would normally be the first systemic therapy given to paediatric LGG patients. No comparison to vincristine alone as the first line chemotherapy is made in the CS for the LGG population.²

2.3.3.2 HGG

In the CS, there are two comparators in the HGG population:

- 1) If the patients have received prior TMZ (prior TMZ subgroup), the comparator is best supportive care (BSC).
- 2) If patient did not receive prior TMZ (no prior TMZ subgroup), the comparator is TMZ.

Best supportive care was “*assumed to encompass pain and symptoms management and psychosocial support*” (CS², page 99). As implemented in the economic model, the company assumed this consisted of one outpatient visit, one non-medical specialist palliative care visit and two specialist nurse visits every four weeks (see Section 4.2.5.2.7.4). No treatments were assumed to be given to patients on best supportive care.

The EAG believes that the comparators in the HGG population, are in line with the scope.¹²

2.3.4 Outcomes

The final scope specifies that the outcomes of interest are:

- overall survival
- progression-free
- survival
- response rates
- duration of response
- adverse effects of treatment
- health-related quality of life (of patients and carers)

The EAG considers that the outcomes reported in the CS is in line with the final scope.¹²

2.3.5 Other relevant factors

The final scope explicitly specifies that “*The use of dabrafenib with trametinib is conditional on the presence of BRAF V600E mutation. The economic modelling should include the costs associated with diagnostic testing for BRAF V600E in people with glioma who would not otherwise have been tested. A sensitivity analysis should be provided without the cost of the diagnostic test.*”¹²

The CS does not include test costs because the company believes that all paediatric patients with glioma would already receive this test.² The EAG’s clinical advisors agree with this position, as testing for mutations when grading glioma is now standard practice and the test for BRAF V600E mutations is on the National Cancer Test Directory.¹⁵

3 CLINICAL EFFECTIVENESS

This chapter presents a summary and critical appraisal of the methods and results of the clinical effectiveness review and evidence synthesis presented within the CS.²

3.1 Critique of the methods of review(s)

The company undertook a systematic literature review (SLR) to identify all clinical evidence regarding the efficacy and safety of D+T and comparator treatments in a paediatric patient population (children and adolescents) with BRAF V600E mutation-positive glioma who have LGG that requires systemic treatment or have HGG that has relapsed, progressed, or failed to respond to previous systemic treatment. Due to the rare nature of the condition and mutation, a secondary objective of the SLR was to include a broader range of studies, irrespective of mutation (molecularly unselected patients). The methods for the company's SLR of clinical evidence are detailed in CS², Appendix D.

3.1.1 Searches

In the EAG clarification letter,¹⁶ the EAG referred to CS² Appendix D identification, selection and synthesis of clinical evidence (page 8), and asked the company to provide the search strategies for the secondary review objective (broader population criterion to 'molecularly unselected patients' irrespective of mutation) for the comparative efficacy evidence for patients with relapsed or refractory HGG if they differ from Section D.1. for the primary review searches (CS², Appendix D, pages 8-15). In the clarification response letter A1,¹⁶ the company confirmed that a single search was carried out for the primary and secondary objectives of the review.

In summary, the EAG has identified limitations in the company search strategy relating to sources searched and limits applied. The company searched several electronic bibliographic databases from inception until May 2023 (Appendix D.1 Identification and selection of relevant studies): MEDLINE (via PubMed), MEDLINE in Process (via PubMed), EMBASE (via Embase.com), Cochrane Database of Systematic Reviews (via Wiley), and Cochrane Central Register of Controlled Trials (CENTRAL, via Wiley). The company hand searched the bibliographies of relevant systematic reviews and meta-analysis to identify other new studies for inclusion.

The company did not search any clinical trials registries such as the clinicaltrials.gov registry/WHO International Clinical Trials Registry Platform (ICTRP) and the EU Clinical Trials Register (EUCTR) for ongoing or completed or unpublished trials. Whilst the company did search CENTRAL which indexes all the trials from ICTRP and ClinicalTrials.gov, there will be small delays of eight weeks and it is recommended that these sources are searched to ensure maximum coverage.

The company searched several key conference abstract websites in the last two years (2022 until present): American Society of Clinical Oncology (ASCO); European Society of Medical Oncology (ESMO); and American Society for Radiation Oncology (ASTRO).

The company have combined terms for glioma with a comprehensive list of intervention and comparators (286 terms) and a highly sensitive paediatric and RCT search filter in Embase (CS² Appendix D.1.1.2. Table 1, pages 9-11). Whilst the terms applied and numbers retrieved in the search were fully reported, the search was limited to English-language publications. According to the Cochrane Handbook of systematic reviews and Campbell Collaboration, applying this limit can introduce language bias.¹⁷

Overall, the EAG considers that the company search strategy was comprehensive and that there were no observable and/or consequential errors. Following communication with the clinical advisors, the EAG is only aware of one study and that there are unlikely to be any studies that have been missed from the company search.

3.1.2 Inclusion criteria

The inclusion criteria for the company's SLR are described in CS² Appendix D.1.2, page 17, Table 7 for the paediatric patient population with LGG and in CS², Appendix D.1.2, page 15, Table 6 for the paediatric patient population with HGG. The specified inclusion and exclusion criteria were mostly appropriate and generally reflect the information given in the decision problem; however, the company's inclusion criteria was broader than the scope in the CS.² The decision problem and the marketing authorisation indicates D+T for the treatment of children and young people with BRAF V600E mutation-positive glioma.

Although the company defined the included population as patients with BRAF V600E mutation as per the NICE scope¹² (primary review objective) it also added a broader secondary review objective which included paediatric patients with glioma, irrespective of mutations (molecularly unselected patients) due to the paucity of data available for paediatric patients with BRAF V600E mutation-positive glioma. Whilst the inclusion criteria differ from the decision problem as set out in the final NICE scope,¹² the EAG agrees with the company's rationale and does not consider it to be problematic, as it would broaden rather than narrow the scope of the review, meaning that the relevant studies would still have been identified.

The final NICE scope¹² listed Health-related quality of life (HRQoL) (of patients and carers) as an outcome of interest whereas the company's SLR inclusion and exclusion criteria does not specify this. However, the company has reported data relating to HRQoL outcomes in the results section. It was

unclear to the EAG why the company excluded studies with fewer than 15 participants from the company's SLR, given that less than 30 children a year develop HGG in the UK.^{6,7}

In response to the EAG's clarification request (question A3)¹⁶ the company provided the following statement "*A pragmatic approach was used and a sample size restriction was introduced to keep the review (for the secondary objective, e.g. studies in molecularly unselected patients) manageable. Despite this restriction, for the primary objective (e.g. BRAF V600 patients), any studies that met the inclusion criteria for the review but had a sample size less than 15 were put aside and assessed to ensure that no relevant studies were excluded based on the sample size criteria alone. Only one study by Nobre et al, 2020 was identified in patients with a BRAF V600E mutation (1), and was subsequently excluded because of the sample size restriction. The study reported outcomes in 11 patients with paediatric HGG treated with a BRAF inhibitor (dabrafenib or vemurafenib), and vemurafenib was not considered a relevant comparator. While a limitation, Novartis believes that this was a pragmatic approach, and no relevant useable studies were excluded.*" In addition, eligibility was restricted to English language publications, which introduces the risk that relevant data not published in the English language may have been missed; however, the EAG does not anticipate that key studies would have been missed due to the above restrictions.

The comparators listed for LGG cohort in CS SLR (CS², Appendix D, page 17, Table 7) was limited to vincristine alone or in combination, whilst the final NICE scope¹² listed chemotherapy, including but not limited to vincristine with carboplatin. The company's rationale for this restricted focus is not entirely clear despite suggesting in CS², page 14, Table 1 that *carboplatin with vincristine is the recommended first-line chemotherapy for LGG as per the UK CCLG guideline¹⁸ and confirmed by clinical experts.^{19, 20}*

3.1.3 Critique of data extraction

CS² Appendix D states that data from the included studies were extracted into a pre-defined data extraction grid in Microsoft® Excel, to ensure that data were extracted uniformly and comparable across the included studies. However, no detail was reported in the CS², Appendix D about the process of data extraction, and thus it is not entirely clear how many reviewers undertook this process, if extracted data was double checked and how any disagreements were resolved, or actions taken to minimise error.

3.1.4 Quality assessment

The quality assessment of the included studies in the CS² for both SLR and the indirect treatment comparison (ITC) were assessed using the Downs and Black checklist²¹ which is designed to evaluate the methodological quality of both randomised and non-randomised comparative studies. The EAG considers this be an appropriate quality assessment tool for the included studies. However, the CS² did

not provide further details on the version of the checklist used, that is the original version with a total maximum score of 31²¹ or the modified version with a total maximum score of 28.^{22, 23}

The company considered the TADPOLE RCT study in LGG cohort as a single arm study. Following clarification question A7¹⁶ the company provided the following justification, “*Please accept our apologies for the confusion. The EAG is correct that the statement “No randomised controlled trials or comparative cohort studies were identified in the review” is misleading, as TADPOLE is an RCT. In the ITC, the TADPOLE study was treated as a single-arm trial in that only the dabrafenib arm was included in the analyses. Therefore, the trial was critically appraised using the Downs and Black checklist along with the single-arm study also included in the primary objective SLR (Bouffet 2023).*” Moreover, it was not clear in the CS² whether quality assessment was conducted by one or more reviewers and how disagreement was resolved; hence, the EAG is unable to comment on the robustness of the quality assessment process.

3.2 Critique of trials of the technology of interest, its analysis and interpretation

3.2.1 Studies included/excluded from the submission

The company presented a SLR of the clinical effectiveness and safety of D+T for the treatment of paediatric patient population (children and adolescents) with LGG or relapsed or refractory HGG with BRAF V600E mutation-positive glioma. Despite minor discrepancies (clarification question A2),¹⁶ the company’s PRISMA (Preferred Reporting Items for Systematic Reviews and Meta-Analyses) flow diagram (see CS², Appendix D, page 21, Figure 1) represents the identification and selection of relevant therapies for the treatment of LGG and HGG in paediatric population and appears to be an adequate record of the literature searching and screening process.

The main primary clinical evidence included in the CS², Section B.2.2 was from the TADPOLE (NCT02684058)¹⁴ study that examined the efficacy and safety of D+T in both the LGG cohort and the HGG cohort. One further study was also included in the CS² to support the clinical evidence base for the LGG cohort; a Phase 1/2 study (NCT02124772),²⁴ which reported the efficacy and safety of trametinib monotherapy or in combination with dabrafenib in a subset of patients with paediatric relapsed/refractory BRAF V600E mutation-positive LGG. As noted in the CS² this study was not used to inform the economic evidence base of the CS² as it was a dose-finding single arm study.

The company also identified another study, Coutant *et al.*,²⁵ in the LGG cohort but no explicit details were provided in the CS² for its exclusion from the analysis. In response to the clarification question A5,¹⁶ the company explained that the study was excluded as it only included patients with Grade I gliomas and therefore represented only a subset of the population of interest. The clinical advisor to the EAG noted that this was not a valid justification for exclusion as the study included paediatric LGG

patients with BRAF V600E mutated tumours. In addition, the paper²⁵ stated that “*As expected, in the global cohort, PLGG with BRAF p.V600E and/or CDKN2A loss exhibited poor outcomes*” and the study authors concluded that “*additionally to the presence of BRAF p.V600E or CDKN2A deletion in grade 1 PLGGs, the absence on diagnostic MRI of cystic parts and/or cystic conversion at 6-month chemotherapy were significantly linked to a worst prognosis and response to treatment.*”²⁵

The study characteristics of the included studies are presented in Table 5.

Table 5: Clinical effectiveness evidence (reproduced from CS², page 32, Table 3)

Study	TADPOLE (NCT02684058) ¹⁴	CTMT212X2101 (NCT02124772) ²⁴
Study design	Phase 2, open-label, multicentre study	Four-part, Phase 1/2 study
Population	Children and young people aged 1 to 17 years with <i>BRAF</i> V600E mutation-positive glioma: <ul style="list-style-type: none"> • LGG • Relapsed or refractory HGG 	Patients with relapsed/refractory malignancies (exhausting any potentially curative treatments including surgery, radiation, chemotherapy, or combination thereof) <ul style="list-style-type: none"> • Part A enrolled patients with solid tumours (i.e. <i>BRAF</i> V600E mutation was not required) • Part B included expansion cohorts for neuroblastoma, <i>BRAF</i>-fusion LGG, NF-1-associated plexiform neurofibroma, and <i>BRAF</i> V600E-mutant tumours • In Parts C and D, patients had <i>BRAF</i> V600E-mutant disease; disease-specific expansion cohorts in Part D included LGG and Langerhans cell histiocytosis
Intervention(s)	Dabrafenib twice daily plus trametinib once daily, dosed based on weight, given orally	Trametinib monotherapy or dabrafenib plus trametinib
Comparator(s)	<i>LGG cohort only</i> : Carboplatin 175 mg/m ² and vincristine 1.5 mg/m ² IV given as one induction course (10 weeks of chemotherapy with 2 weeks of rest), followed by 8 cycles of maintenance chemotherapy (6 weeks)	N/A
Indicate if study supports application for marketing authorisation	Yes	Yes
Indicate if study used in the economic model	Yes	No
Rationale if study not used in model	N/A	The study was a single-arm study, and there were limitations associated with design (dose-finding study)

Study	TADPOLE (NCT02684058) ¹⁴	CTMT212X2101 (NCT02124772) ²⁴
Study design	Phase 2, open-label, multicentre study	Four-part, Phase 1/2 study
Reported outcomes specified in the decision problem	<p><u>Primary outcomes:</u></p> <ul style="list-style-type: none"> • ORR defined as the percentage of patients with confirmed PR or CR according to RANO criteria^{26, 27} using independent review assessment <p><u>Secondary outcome:</u></p> <ul style="list-style-type: none"> • ORR using investigator assessment • Overall survival • Progression-free survival 	<ul style="list-style-type: none"> • Adverse events • ORR • PFS • OS
All other reported outcomes	<ul style="list-style-type: none"> • Treatment effect for PFS • Time to death following progression • Time to treatment discontinuation 	<ul style="list-style-type: none"> • BOR • DOR • CBR • RP2D • Average Steady State Plasma Concentration

Abbreviations: BOR, best overall response; BRAF, v-raf murine sarcoma viral oncogene homolog B; CBR, clinical benefit rate; DOR, duration of response; HGG, high-grade glioma; IV, intravenous; LGG, low-grade glioma; NF-1, neurofibromatosis type 1; ORR, overall response rate; OS, overall survival; PFS, progression-free survival; RANO, Response-Assessment for Neuro-Oncology; RP2D, recommended Phase 2 dose; SoC, standard of care.

3.2.2 Main evidence (TADPOLE Study)

The TADPOLE study is a multicentre, open-label, Phase II study¹¹ designed to evaluate the effect of D+T in children and adolescent patients with BRAF V600E mutation-positive LGG or relapsed or refractory HGG. The trial comprised of three study periods: a screening period; a treatment period; and a post-treatment follow-up. The TADPOLE study¹¹ recruited patients at 58 sites across 20 countries, including three UK centres, from September 2018 through December 2020. After patients' tumours were graded, they were then either allocated to an RCT if they had LGG or a single arm prospective cohort study if they had HGG. Further details are provided below and a detailed overview is provided in the CS², page 34-35, Figures 4 and 5.

The TADPOLE LGG RCT cohort is a multi-centre, randomised, open-label component of the TADPOLE Phase II study¹¹ conducted in children and adolescent patients with BRAF V600E mutation-positive LGG, whose tumour was unresectable and required first systemic treatment. In total, 110 participants were randomised in a 2:1 ratio to either D+T (N=73) or chemotherapy C+V (N=37).

The TADPOLE HGG prospective cohort is a multi-centre, single-arm, open-label component of the Phase II TADPOLE study¹¹ conducted in children and adolescent patients with BRAF V600E mutation-positive, refractory, or relapsed HGG tumours after having received at least one previous standard therapy. A total of 41 patients were enrolled to receive D+T.

All participants (both the LGG and the HGG cohorts) after discontinuation of study treatment, were followed for safety for at least 30 days after the last dose of study treatment. Participants who discontinued study treatment for reasons other than disease progression, death, loss to follow up, or withdrawal of consent moved into the post-treatment follow-up phase. Finally, all participants were followed for survival once they discontinued study treatment for at least 2 years after the last patient first study treatment (except if consent was withdrawn, death occurred, or the patient was lost to follow-up or discontinued study)

3.2.2.1 Patients

Eligibility criteria for the TADPOLE trial¹¹ are presented in the CS², page 37 and CS², Appendix M. Clinical advisors to the EAG have confirmed that the eligibility criteria for the study is reasonable. The population met the specification of the NICE final scope,¹² in being aged between ≥ 12 months and < 18 years with BRAF V600E mutation-positive glioma.

The LGG cohort included patients who had Grade I or II glioma who need to begin a first systemic treatment. This means that the LGG cohort either had experienced a disease progression following an observation period after receiving a surgical excision or were ineligible for surgery. The HGG cohort included patients with Grade III to IV glioma who had relapsed, progressed, or failed to respond to first-line therapy (includes surgical (if possible), immediately followed by radiation and/or chemotherapy). Glioma grade in both LGG and HGG cohorts were defined using the WHO histological classification system²⁸ and the BRAFm tumour was assessed locally, or at a Novartis designated central reference laboratory if local BRAF V600E testing was unavailable. According to the clinical advisors to the EAG, the assessment of the BRAFm tumour is acceptable and BRAFm is routinely assessed within NHS clinical practice. All patients had to have centrally confirmed measurable disease according to Response Assessment in Neuro-Oncology (RANO) criteria,^{26, 27} and have a performance score of $\geq 50\%$ on either the Karnofsky performance scale (KPS) (for patients ≥ 16 years of age) or the Lansky performance scale (LPS) (for those < 16 years of age).^{26, 27}

The key exclusion criteria for HGG or LGG were exclusion of glioma malignancy other than BRAF V600E mutation; previous treatment with dabrafenib or another RAF inhibitor, trametinib or another mitogen-activated protein kinase (MEK) inhibitor, or an extracellular signal-regulated kinase inhibitor; history of malignancy with confirmed activating rat sarcoma virus (RAS) mutation or with BRAF fusion such as BRF-KIAA1549 or with known diagnosis of neurofibromatosis type 1; unresolved toxicity greater than NCI CTCAE v4.03 Grade 2 from previous anti-cancer therapy.

In addition, patients with LGG were not eligible if they had any systemic anti-cancer therapy (chemotherapy, immunotherapy, biologic therapy, or vaccine therapy) or investigational drugs prior to

enrolment or radiotherapy to CNS glioma lesions at any point prior to enrolment. Patients with HGG were not eligible if they had anti-cancer therapy (chemotherapy with delayed toxicity, immunotherapy, biologic therapy, vaccine therapy) or investigational drugs ≤ 3 weeks preceding the first dose of study treatment or radiotherapy to CNS glioma lesions ≤ 3 months prior to first dose of study treatment, unless there was clear evidence of radiologic progression outside of the field of radiation.

3.2.2.2 *Intervention*

The intervention group in the TADPOLE trial¹¹ received D+T. Dosing of D+T was dependent on age and weight. Dabrafenib was dosed orally at 2.625 mg/kg twice daily for ages <12 years and at 2.25 mg/kg twice daily for ages 12 years and older; trametinib was dosed orally at 0.032 mg/kg once daily for ages <6 years, and at 0.025 mg/kg once daily for ages 6 years and older. Dabrafenib doses were capped at 150 mg twice daily and trametinib doses at 2 mg once daily. Dabrafenib could be administered either as a capsule or dispersible tablet for oral suspension and trametinib could be administered as an oral solution or a tablet. Full details of dosage and formulation for D+T are presented in the CS² (page 36). The dosage and formulation are consistent with the proposed licensed dose in the draft SmPC.²⁹ Dose modification or dosing interruptions were mandated in patients who did not tolerate the protocol-specified dosing schedule to allow patients to continue the study treatment. Guidelines regarding management and dose reduction for adverse events (AEs) that were considered by the investigator to be related to study treatment are available in the CS², Appendix M with results presented in Section 3.2.6.1.4.1 and Section 3.2.6.2.3.1. If more than two dose reductions were needed, the patient was to be discontinued from study treatment. Patients who discontinued study treatment due to AEs were to be followed until resolution or stabilisation of the event.

Treatment with D+T was continued until disease progression using RANO criteria^{26,27} or loss of clinical benefit as determined by the investigator, unacceptable toxicity, start of a new anti-neoplastic therapy, discontinuation at the discretion of the investigator or patient/legal guardian, loss to follow-up, death, or study termination by the sponsor.

Permitted and non-permitted concomitant treatments are presented in the CS², Appendix M, Table 7. Clinical advisors to the EAG have confirmed that these are reasonable.

3.2.2.3 *Comparator*

The comparator in the TADPOLE study¹¹ for the LGG RCT cohort was C+V. Carboplatin 175 mg/m² and vincristine 1.5 mg/m² were administered intravenously as one course of induction (10 weeks of chemotherapy with two weeks of rest), followed by eight cycles of maintenance chemotherapy. Each maintenance cycle was six weeks. Patients randomised to the C+V arm were allowed to cross over to receive D+T after centrally-confirmed disease progression (as defined by RANO).^{26,27} Crossover was permitted during the treatment period or the post-treatment period. Patients who crossed over were to

continue protocol-specified evaluations, including efficacy and safety assessments. Patients continued for the prescribed number of cycles, as tolerated or until unacceptable toxicity, start of a new anti-neoplastic therapy, discontinuation at the discretion of the investigator or patient/legal guardian, lost to follow-up, death occurred, the study is terminated by the sponsor or until disease progression.

The TADPOLE study¹¹ with the HGG cohort adopted a single-arm design; hence, no comparator was included. The CS² provided an indirect treatment comparison (ITC) in the absence of head-to-head trials. Further details are provided in the ITC critique Section 3.4 and 3.5.

3.2.2.4 Outcomes

Patients were assessed at screening (within 28 days before initiation of study treatment) and every eight weeks for the first year, and every 16 weeks thereafter for efficacy, using RANO criteria.^{26, 27} All radiological scans were collected for independent central review.

The primary efficacy outcome was overall response rate (ORR) defined as the percentage of patients with confirmed partial response (PR) or complete response (CR) per RANO criteria,^{26, 27} as evaluated by independent central reviewer. Secondary outcomes included:

- ORR using investigator assessment by RANO criteria.^{26, 27}
- Duration of response (DOR), calculated as the time from the first documented confirmed response (CR or PR) to the first documented progression or death due to any cause, as assessed separately by investigator and independent central reviewer by RANO criteria.^{26, 27}
- Overall survival (OS), defined as the time from date of randomisation to death due to any cause.
- Progression-free survival (PFS), defined as time from date of randomisation to progression or death due to any cause, as assessed separately by central independent reviewer and investigator by RANO criteria.^{26, 27}
- Time to Response (TTR), calculated as the time from the date of randomisation to first documented confirmed response (CR or PR) as assessed separately by investigator and independent central reviewer by RANO criteria.^{26, 27}
- Clinical Benefit Rate (CBR), defined as the proportion of patients with a best overall response (BOR) of CR or PR, or an overall lesion response of stable disease which lasts for a minimum time duration of at least 24 weeks, as assessed separately by investigator and independent central reviewer by RANO criteria.^{26, 27}
- HRQoL, assessed with the Patient Reported Outcomes Measurement Information Service (PROMIS) Parent Proxy Global Health 7+2.³⁰ This measure includes a global health score plus a single score from pain and a score from fatigue interference item which were scored independently. A higher score for global health indicates better overall wellbeing; a higher score for pain and fatigue indicates worsening pain and fatigue.

- AE, defined by the National Cancer Institute Common Terminology Criteria for Adverse Events v4.03.
- Other reported outcomes were treatment effect for PFS, time to death following progression and time to treatment discontinuation.

3.2.3 Supporting Evidence (NCT02124772 study)²⁴

The NCT02124772 study²⁴ was a Phase 1/2, multicentre, open label, four part study investigating the safety, pharmacokinetics, pharmacodynamics and clinical activity of trametinib monotherapy and D+T combination therapy for the treatment of advanced solid tumours in paediatric patients aged 1 month to less than 18 years. As the CS² primarily focuses on the combination therapy of D+T in BRAF V600 mutation-positive LGG patients, the CS² only included 2 parts of the study (Part C and D) which were relevant to the submission and therefore summarised in this report:

- Part C: A dose escalation phase in subjects with recurrent, refractory, or unresectable BRAF V600 mutated tumours, which aimed to establish the recommended phase II doses (RP2D) of combination therapy.
- Part D: D+T with disease-specific, dose-expansion study aimed to evaluate the safety, tolerability, and preliminary activity of D+T in subjects with recurrent, refractory, or unresectable BRAF V600 mutated tumours.

The eligibility criteria for the NCT02124772²⁴ (part C and D) study are reported in CS², Appendix O and Bouffet *et al.*,³¹ In brief the study included paediatric LGG patients (<18 years) with BRAF V600-mutant disease who had relapsed/refractory malignancies (exhausting any potentially curative treatments including surgery, radiation, chemotherapy, or combination thereof), and a KPS/LPS status of $\geq 50\%$.³² The disease-specific expansion cohorts in Part D also included patients with Langerhans cell histiocytosis but they were excluded from the efficacy analysis.

A total of 36 patients with BRAF V600-mutant glioma received D+T: 16 patients in Part C study and 20 patients in part D. Efficacy and safety were assessed in all patients who received ≥ 1 dose of study treatment; radiographic disease assessments were performed at baseline, every 8 weeks, and then every 12 weeks and evaluated by independent radiology review and investigators using RANO criteria.^{26, 27}

Outcomes assessed included ORR (complete and partial response) per RANO criteria;^{26, 27} BOR; CBR; DOR; PFS, survival functions were estimated using the KM method; and AE, defined by the National Cancer Institute Common Terminology Criteria for Adverse Events v4.03.

3.2.4 Ongoing studies

As reported in the CS,² page 85, there are three ongoing studies of D+T in paediatric patients with gliomas (Table 6).

Table 6: Ongoing studies of dabrafenib with trametinib in paediatric gliomas (reproduced from CS², page 85, Table 37)

Study number	Study objective	Study design	Estimated completion
NCT04201457 ³³	To study the side effects, best dose and efficacy of adding hydroxychloroquine to dabrafenib and/or trametinib in children with <i>BRAF</i> ^m LGGs or HGGs previously treated with similar drugs, that did not respond completely or recurrent tumours after receiving a similar agent	Open-label, multicentre, non-randomised, Phase 1/2 study	June 2027
NCT03919071 ³⁴	To study how well the combination of dabrafenib and trametinib works after radiation therapy in children and young adults with HGG and a <i>BRAF</i> V600 mutation	Open-label, multicentre, single-arm, Phase 2 study	September 2027
NCT03975829 ³⁵	A roll-over study to assess long-term effect in paediatric patients treated with dabrafenib and/or trametinib	Open-label, multicentre, rollover Phase 4 study. Patients from TADPOLE, Study NCT01677741, or Study NCT02124772 were eligible for inclusion	July 2026

Abbreviations: BRAF, v-raf murine sarcoma viral oncogene homolog B; BRAF^m, v-raf murine sarcoma viral oncogene homolog B mutation positive; HGG, high-grade glioma; LGG, low-grade glioma.

3.2.4.1 Details of relevant RCTs not included in the submission.

Neither the EAG nor clinical advisors to the EAG were aware of any additional studies within the scope of this appraisal.

3.2.5 Summary and critique of the company's quality assessment

The CS² presented a table of methodological quality assessment of the included study based on the Downs and Black check list,²¹ but an accompanying narrative summary was not provided. In response to the clarification question (A7)¹⁶ the company reported “*The Downs and Black checklist includes a cumulative score, which ranged from 21 in Bouffet 2023 to 25 in TADPOLE. The difference in overall score was due to more thorough reporting of probability values for main outcomes, reporting of compliance data, and reporting of confounding variables in TADPOLE compared with Bouffet 2023.*” Despite the clarification provided by the company it was still unclear to the EAG, which version of the

checklist was used as noted in Section 3.1.4; what the total maximum score was and the interpretation of the scoring. The company's clarification response (A7)¹⁶ confirmed that the TADPOLE LGG was an RCT study. Although the company did not re-assess the TADPOLE LGG cohort as an RCT, it did not have a significant impact on the overall assessment, see Table 3.

A summary of the methodological quality assessment undertaken by the company alongside the EAG is presented in Table 7. The scoring between the company and the EAG was mostly similar, however the EAG notes that checklist item 11 (Is the source of funding clearly stated?), is not part of Downs and Black checklist²¹ and therefore would increase the overall score. Whilst the company did not provide interpretation of the scoring and quality of the study, the EAG notes that in accordance with previous publications,^{21, 23, 36, 37} the TADPOLE LGG RCT³⁸ would be considered as a good quality study (scoring between 20–25) whereas Bouffet *et al.*,³¹ study would be considered as fair quality study (scoring between 15–19) by the EAG. The EAG notes that the accumulative score for Bouffet *et al.*,³¹ is 20 not 21 as stated in clarification response (A7).¹⁶ No attempt has been made in the CS² to integrate the assessment of study quality into the findings reported in the CS², or to consider the overall impact of the quality of the included studies on the results.

Table 7: Quality assessment of LGG studies (CS², Appendix D, Table 11)

	Checklist item	TADPOLE ³⁸				Bouffet 2023 ³¹			
		Company's assessment		EAG's assessment		Company's assessment		EAG's assessment	
		Assessment	Score	Assessment	Score	Assessment	Score	Assessment	Score
Reporting Yes = 1, No/Unable to determine = 0									
1	Is the objective of the study clear?	Yes	1	Yes	1	Yes	1	Yes	1
2	Are the main outcomes clearly described in the Introduction or Methods?	Yes	1	Yes	1	Yes	1	Yes	1
3	Are characteristics of the patients included in the study clearly described?	Yes	1	Yes	1	Yes	1	Yes	1
4	Are the interventions clearly described?	Yes	1	Yes	1	Yes	1	Yes	1
5	Are the distributions of principal confounders in each group of subjects clearly described?	Yes	2	Yes	2	Yes	2	Yes	1
6	Are the main findings of the study clearly described?	Yes	1	Yes	1	Yes	1	Yes	1
7	Does the study estimate random variability in data for main outcomes?	Yes	1	Yes	1	Yes	1	Yes	1
8	Have all the important adverse events consequential to the intervention been reported?	Yes	1	Yes	1	Yes	1	Yes	1
9	Have characteristics of patients lost to follow-up been described?	Yes	1	Yes	1	Yes	1	Yes	1
10	Have actual probability values been reported for the main outcomes except probability < 0.001?	Yes	1	Yes	1	Unable to determine	0	Unable to determine	0

	Checklist item	TADPOLE ³⁸				Bouffet 2023 ³¹			
		Company's assessment		EAG's assessment		Company's assessment		EAG's assessment	
		Assessment	Score	Assessment	Score	Assessment	Score	Assessment	Score
11	Is the source of funding clearly stated?	Yes	1	Yes	1	Yes	1	Yes	1
External validity									
12	Were subjects who were asked to participate in the study representative of the entire population recruited?	Yes	1	Yes	1	Yes	1	Yes	1
13	Were those subjects who were prepared to participate representative of the recruited population?	Yes	1	Yes	1	Yes	1	Yes	1
14	Were staff, places, and facilities where patients were treated representative of treatment most received?	Yes	1	Yes	1	Yes	1	Yes	1
Internal validity									
15	Was an attempt made to blind study subjects to the intervention?	No	0	No	0	No	0	No	0
16	Was an attempt made to blind those measuring the main outcomes?	No	0	No	0	No	0	No	0
17	If any of the results of the study were based on data dredging was this made clear?	Yes	1	Yes	1	Unable to determine	0	Unable to determine	0
18	Was the time period between intervention and outcome the same for intervention and control groups or adjusted for?	Yes	1	Yes	1	Yes	1	Yes	1
19	Were the statistical tests used to assess main outcomes appropriate?	Yes	1	Yes	1	Yes	1	Yes	1
20	Was compliance with the interventions reliable?	Yes	1	Yes	1	Unable to determine	0	Unable to determine	0

	Checklist item	TADPOLE ³⁸				Bouffet 2023 ³¹			
		Company's assessment		EAG's assessment		Company's assessment		EAG's assessment	
		Assessment	Score	Assessment	Score	Assessment	Score	Assessment	Score
21	Were main outcome measures used accurate? (valid and reliable)	Yes	1	Yes	1	Yes	1	Yes	1
Internal validity-confounding (selection bias)									
22	Were patients in different intervention groups recruited from the same population?	Yes	1	Yes	1	Yes	1	Yes	1
23	Were study subjects in different intervention groups recruited over the same period of time?	Yes	1	Yes	1	Yes	1	Yes	1
24	Were study subjects randomized to intervention groups?	No	0	Yes	1	No	0	No	0
25	Was the randomized intervention assignment concealed from patients and staff until recruitment was complete?	No	0	No	0	Not applicable	0	Not applicable	0
26	Was there adequate adjustment for confounding in the analyses from which main findings were drawn?	Yes	1	Yes	1	No	0	No	0
27	Were losses of patients to follow-up taken into account?	Yes	1	Yes	1	Yes	1	Yes	1
Power									
28	Was the study sufficiently powered to detect clinically important effects where probability value for a difference due to chance is <5%?	Yes	1	Yes	1	Unable to determine	0	Unable to determine	0
	Total score		25		26		20		19

3.2.6 Summary and critique of results

This section presents the results (as reported by the company) from the TADPOLE trial,¹¹ which forms the pivotal evidence in the CS² for the efficacy and safety of D+T in paediatric patients with BRAF V600E mutation-positive LGG and HGG. Results of the LGG cohort from a Phase 1/2 study (NCT02124772)²⁴ has also been presented here as additional clinical evidence to support the LGG cohort from the TADPOLE trial.¹¹ Further information, not reported in the CS² was provided by the company in its response to the clarification questions raised by the EAG. Where applicable, data have been re-tabulated by the EAG to ensure clarity.

3.2.6.1 LGG RCT Cohort

3.2.6.1.1 Demographic and baseline characteristics

A total of 121 patients were screened for entry into the LGG cohort, of whom 110 patients were recruited upon completion of the screening phase and were randomised in a 2:1 ratio to the D+T arm (N=73) or the C+V arm (N=37). Most of the patients' characteristics were well balanced between the two treatment groups at baseline (Table 8).

The median age of patients with LGG was 9.5 years (range 1–17). Most of the patients were White (72.7%) although a higher population of Black or African American were in the C+V arm compared with D+T arm (8.1% vs 2.7%, respectively). However, there is limited knowledge regarding the specific incidence of BRAF V600E mutation by race and ethnicity in paediatric patients with LGG therefore it is unclear the effect this will have on the efficacy outcomes. There were more female than male patients (60.0% vs 40.0%). None of the patients had a KPS/LPS score³² below 70 at study entry. The most frequent investigator-determined histologic types of glioma were pilocytic astrocytoma (30.9%), ganglioglioma (27.3%), low-grade glioma not otherwise specified (18.2%), and pleomorphic xanthoastrocytoma (10%). The majority of patients (80.0%) were presented with Grade I gliomas, with 18.2% of patients presenting with Grade II disease, although it should be noted that there was a slightly higher number of patients with Grade II gliomas in the C+V arm compared with D+T arm (21.6% vs 16.4%, respectively). Most patients across the treatment arms had prior surgery (85% in the D+T arm and 78% in the C+V arm); none of the patients received chemotherapy or radiotherapy prior to study enrolment. All patients, except for two, had gliomas with BRAF V600E mutation. Many disease metrics were listed as an indication to treatment. The majority of patients (53.6%) had radiologic progression as a component of the need for systemic therapy, although this was more common in those randomised to D+T arm (60.3%) vs C+V arm (40.5%). It is unclear how this and other reasons to treat, which were asymmetrically distributed between treatment arms could affect efficacy results. The mean time since initial diagnosis to study entry was 6.5 months in the C+V arm and 15.4 months in the D+T arm. Despite the variation noted in the baseline study characteristics, the clinical advisors to the EAG agreed that the

study population demographic characteristics are generally representative of the patients with LGG seen in UK routine clinical practice.

As reported in the U.S. Food and Drug Administration (FDA) assessment report,³⁹ all patients received at least 1 concomitant medication during the study. The most commonly administered concomitant medications (used in $\geq 20\%$ of patients) were paracetamol (69.9% vs 66.7%), ondansetron (20.5% vs 84.8%), bactrim (5.5% vs 57.6%), ibuprofen (32.9% vs 21.2%), and dexamethasone (15.1% vs 24.2%) in the D+T vs C+V arms, respectively.

All study withdrawals were adequately described, and all patients were accounted for in the TADPOLE LGG RCT. As of the final analysis data cut-off (DCO) (28th of April 2023), 56/73 (76.7%) in the D+T arm and 14/37 (37.8%) in the C+V arm had completed treatment. In total, 61 (83.6%) patients in D+T arm and 26 (78.8%) patients in C+V arm experienced AEs leading to dose adjustment/interruption. In the D+T arm, 4/73 (5.5%) discontinued treatment due to disease progression and 3/73 (4.1%) due to AE. In the C+V arm 10/37 (27.0%) discontinued treatment due to disease progression and 8/37 (21.6%) due to AE).

Table 8: Demographics and baseline disease characteristics, FAS-LGG (reproduced from CS², page 44, Table 8)

	D+T (N=73)	C+V (N=37)	All patients (N=110)
Demographics			
Age (years)			
Mean (SD)	9.3 (4.97)	8.8 (5.01)	9.1 (4.96)
Median	10.0	8.0	9.5
Q1–Q3	5.0–13.0	4.0–13.0	5.0–13.0
Min, Max	1.0–17.0	1.0–17.0	1.0–17.0
Age category, n (%)			
12 months–<6 years	20 (27.4)	14 (37.8)	34 (30.9)
6–<12 years	25 (34.2)	11 (29.7)	36 (32.7)
12–<18 years	28 (38.4)	12 (32.4)	40 (36.4)
Sex, n (%)			
Female	44 (60.3)	22 (59.5)	66 (60.0)
Male	29 (39.7)	15 (40.5)	44 (40.0)
Race, n (%)			
White	55 (75.3)	25 (67.6)	80 (72.7)
Asian	5 (6.8)	3 (8.1)	8 (7.3)
Black or African American	2 (2.7)	3 (8.1)	5 (4.5)

	D+T (N=73)	C+V (N=37)	All patients (N=110)
Demographics			
Unknown	6 (8.2)	4 (10.8)	10 (9.1)
Other	3 (4.1)	1 (2.7)	4 (3.6)
Not reported	2 (2.7)	1 (2.7)	3 (2.7)
Ethnicity, n (%)			
Not Hispanic or Latino	48 (65.8)	17 (45.9)	65 (59.1)
Hispanic or Latino	8 (11.0)	4 (10.8)	12 (10.9)
Unknown	5 (6.8)	5 (13.5)	10 (9.1)
Not reported	12 (16.4)	11 (29.7)	23 (20.9)
Weight (kg)			
No. of patients	73	33	106
Mean (SD)	43.02 (26.364)	43.81 (26.527)	43.27 (26.291)
Median	36.50	38.20	36.75
Q1–Q3	22.30–61.80	22.40–60.60	22.30–61.80
Min, Max	7.8–115.0	9.0–110.3	7.8–115.0
BMI (kg/m ²)			
No. of patients	73	33	106
Mean (SD)	21.73 (10.594)	21.43 (6.128)	21.64 (9.403)
Median	19.39	20.13	19.50
Q1–Q3	16.81–24.02	17.37–23.91	16.92–24.02
Min, Max	13.1–97.7	15.5–40.9	13.1–97.7
BSA (m ²)			
No. of patients	73	33	106
Mean (SD)	1.26 (0.516)	1.27 (0.506)	1.26 (0.510)
Median	1.22	1.26	1.22
Q1–Q3	0.85–1.66	0.86–1.69	0.86–1.69
Min, Max	0.4–2.4	0.5–2.3	0.4–2.4
Lansky and Karnofsky performance status, n (%)			
No. of patients	73	33	–
100	44 (60.3)	17 (51.5)	–
90	20 (27.4)	12 (36.4)	–
80	7 (9.6)	2 (6.1)	–
70	2 (2.7)	2 (6.1)	–
<70	0	0	–
Baseline disease characteristics			
Pathology at initial diagnosis, n (%)			

	D+T (N=73)	C+V (N=37)	All patients (N=110)
Demographics			
Astrocytoma	1 (1.4)	1 (2.7)	2 (1.8)
Desmoplastic astrocytoma, NOS	0	1 (2.7)	1 (0.9)
Desmoplastic infantile astrocytoma	2 (2.7)	1 (2.7)	3 (2.7)
Diffuse astrocytoma	1 (1.4)	1 (2.7)	2 (1.8)
Diffuse glioma, NOS	2 (2.7)	0	2 (1.8)
Ganglioglioma	21 (28.8)	9 (24.3)	30 (27.3)
Glioneuronal, NOS	2 (2.7)	1 (2.7)	3 (2.7)
Infantile desmoplastic ganglioglioma	1 (1.4)	0	1 (0.9)
LGG, NOS	14 (19.2)	6 (16.2)	20 (18.2)
Pilocytic astrocytoma	22 (30.1)	12 (32.4)	34 (30.9)
Pleomorphic xanthoastrocytoma	6 (8.2)	5 (13.5)	11 (10.0)
Missing	1 (1.4)	0	1 (0.9)
Histological grade at initial diagnosis, n (%)			
Grade I	60 (82.2)	28 (75.7)	88 (80.0)
Grade II	12 (16.4)	8 (21.6)	20 (18.2)
Grade III	0	0	0
Grade IV	0	0	0
Missing	1 (1.4)	1 (2.7)	2 (1.8)
Time since initial diagnosis of primary site to study entry (months)			
No. of patients	73	33	106
Mean (SD)	15.4 (31.69)	6.5 (11.57)	12.7 (27.32)
Median	4.6	2.4	3.4
Q1–Q3	1.8–14.2	1.9–3.8	1.8–10.4
Min, Max	0.9–199.9	0.7–62.2	0.7–199.9
<i>BRAF</i> mutation status [†]			
V600E	72 (98.6)	35 (94.6)	107 (97.3)
Non-mutant	0	1 (2.7)	1 (0.9)
Other	1 (1.4)	0	1 (1.4)
Missing	0	1 (2.7)	1 (0.9)
Indication to treatment			
Blindness, one eye, low vision other eye	2 (2.7)	2 (5.4)	4 (3.6)
Clinical progression	21 (28.8)	7 (18.9)	28 (25.5)

	D+T (N=73)	C+V (N=37)	All patients (N=110)
Demographics			
Deterioration of visual acuity	19 (26.0)	11 (29.7)	30 (27.3)
Diencephalic syndrome of infancy	1 (1.4)	0	1 (0.9)
Neurologic symptoms	31 (42.5)	19 (51.4)	50 (45.5)
Nystagmus	9 (12.3)	5 (13.5)	14 (12.7)
Pressure effect of tumour mass	17 (23.3)	10 (27.0)	27 (24.5)
Radiological progression	44 (60.3)	15 (40.5)	59 (53.6)
Abnormal vision	22 (30.1)	19 (51.4)	41 (37.3)
Missing	1 (1.4)	0	1 (0.9)
Any metastatic sites			
Yes	7 (9.6)	2 (5.4)	9 (8.2)
No	66 (90.4)	35 (94.6)	101 (91.8)

Note: Presence/absence of target and non-target lesions based on the data collected on RANO target/non-target lesion assessment eCRF pages.

†Local *BRAF* is presented when available, otherwise, central *BRAF* is presented. Four patients were enrolled with central *BRAF* status; three patients had local *BRAF* status of 'other' that were V600E centrally. In addition, one patient withdrew consent prior to treatment, with no local result entered, prior to central result analysis.

Abbreviations: BMI, body mass index; BRAF, v-raf murine sarcoma viral oncogene homolog B; BSA, body surface area; C, carboplatin; D, dabrafenib; eCRF, electronic case report form; FAS, full analysis set; LGG, low-grade glioma; NOS, not otherwise specified; Q, quartile; RANO, Response-Assessment for Neuro-Oncology; SD, standard deviation; T, trametinib; V, vincristine.

3.2.6.1.2 Efficacy results

The CS² states that the primary efficacy analysis in the LGG cohort was performed on a full analysis set (FAS) and was on the comparison of ORR based on an independent review assessment between the two treatment arms. The efficacy results for the LGG RCT cohort^{11 38} by the blinded independent reviewer and investigator assessment reviewer at both the primary analysis data cut (23rd of August 2021) and the final analysis data cut (28th of April 2023) are presented in Table 9. Overall, there were no major concerns regarding the efficacy data between the different data cuts.

Supportive and sensitivity analyses for the primary endpoint were performed using the evaluable analysis set. The analyses of ORR, DOR, and PFS were repeated based on radiological response assessed by independent review by only incorporating the radiographic data in the FAS. In addition, ORR, DOR, and PFS were evaluated using an intention-to-treat (ITT) approach, i.e., including all response assessments irrespective of new anti-neoplastic therapy using the FAS.

Efficacy results by blinded independent review by RANO criteria^{26, 27} is summarised below. The overall response rate by blinded independent review by RANO criteria,^{26, 27} demonstrated a clinically meaningful improvement among the 73 patients treated with D+T (ORR: 54.8%; 95% CI: 42.7, 66.5) compared with 37 patients treated with C+V (ORR: 16.2%; 95% CI: 6.2, 32.0), with an odds ratio (OR)

of 6.26 (95% CI: 2.3, 16.8). Results of ORR per investigator assessment were consistent with those observed per independent review and the concordance of BOR between independent review and investigator assessment was 65.5%. CR was reported in three patients (4.1%) in the D+T arm, and in none of the patients in the C+V arm. A higher CBR was demonstrated in the D+T arm (CBR 91.8%; 95% CI: 83.0, 96.9) compared with the C+V arm (CBR 56.8%; 95% CI: 39.5, 72.9). As mentioned by the FDA,³⁹ the EAG agrees that CBR is not considered to be a clinically relevant endpoint for efficacy evaluation.

As reported by the independent reviewer, progressive disease as best response was 5.5% in D+T patients and 24.3% in C+V patients. Among the 40 responders (CR or PR) in the D+T arm, 20 patients (50%) had subsequently experienced disease progression or death, with an estimated median DOR of 30.0 months (95% CI: 16.6, NE), whereas the estimated median DOR was 19.4 months (95% CI: 6.6, NE) for the six responders in the C+V arm. Using descriptive statistics, among patients with a confirmed response, the median TTR was 3.7 months vs 4.6 months in the D+T vs the C+V arm, respectively.

The median PFS was longer in D+T arm (24.9 months; 95% CI: 12.9, 31.6) compared with the C+V arm (7.2 months; 95% CI: 2.8, 11.2) hazard ratio (HR) 0.36; 95% CI: 0.22, 0.59, with an estimated 64% risk reduction in progression/death. There were 44 patients (60.3%) in the D+T arm and 26 patients (70.3%) in the C+V arm with PFS events; all patients had disease progression. A difference in progression events was noted between independent and investigator assessments in the two arms, 44 vs 23 events in D+T arm and 26 vs 15 events in C+V arm, respectively.

At the time of analysis, the data for OS was immature, with no deaths reported in the D+T arm and one death reported in the C+V arm which was due to underlying disease as reported in the company's clarification response A10.¹⁶ The KM methods used to estimate response duration, PFS, OS, and TTR by the independent reviewer are presented in the following places (CS², page 52, Figure 6; page 54, Figure 8 and Appendix N).

Twelve patients in the C+V arm, who had centrally-confirmed and RANO-defined^{26, 27} disease progression, crossed over to receive D+T. ORR per independent review was 41.7% (5/12) (95% CI: 15.2, 72.3) in the crossover arm; all five responses were PR. The CBR was 75.0% (9/12) (95% CI: 42.8, 94.5).

Overall, as noted in the FDA assessment,³⁹ the sample size for the randomised comparison in the LGG cohort was calculated to adequately power the analysis of primary endpoint only (80% power to detect a difference in ORR of 30% while maintaining a one-sided Type I error probability of 0.025). Secondary

Confidential until published

endpoints of PFS and OS were tested in a hierarchical order; however, the trial was not designed to evaluate these endpoints with adequate power.

Table 9: Efficacy results for the TADPOLE LGG cohort using RANO criteria^{26, 27} on full analysis set (reproduced from CS², Table 10, Table 11, Table 12, Table 13 and CS², Appendix N)

	Final analysis data cut (28th April 2023)				Primary analysis data cut (23rd August 2021)			
	Independent Reviewer Assessment		Investigator Assessment		Independent Reviewer Assessment		Investigator Assessment	
	D+T (N=73) n (%)	C+V (N=37) n (%)	D+T (N=73) n (%)	C+V (N=37) n (%)	D+T (N=73) n (%)	C+V (N=37) n (%)	D+T (N=73) n (%)	C+V (N=37) n (%)
Best overall response								
CR, n (%)	2 (2.7)	1 (2.7)	3 (4.1)	0	2 (2.7)	1 (2.7)	3 (4.1)	0
PR, n (%)	38 (52.1)	5 (13.5)	40 (54.8)	7 (18.9)	32 (43.8)	3 (8.1)	37 (50.7)	5 (13.5)
Stable disease, n (%)	24 (32.9)	12 (32.4)	25 (34.2)	15 (40.5)	30 (41.1)	15 (40.5)	28 (38.4)	18 (48.6)
PD, n (%)	8 (11.0)	13 (35.1)	4 (5.5)	9 (24.3)	8 (11.0)	12 (32.4)	4 (5.5)	7 (18.9)
Unknown, n (%)	1 (1.4)	6 (16.2)	1 (1.4)	6 (16.2)	1 (1.4)	6 (16.2)	1 (1.4)	7 (18.9)
ORR, n (%)	40 (54.8) 95% CI: 42.7, 66.5	6 (16.2) 95% CI:6.2, 32.0	43 (58.9) 95% CI:46.8, 70.3	7 (18.9) 95% CI:8.0, 35.2	34 (46.6) 95% CI:34.8, 58.6	4 (10.8) 95% CI:3.0, 25.4	40 (54.8) 95% CI:42.7, 66.5	5 (13.5) 95% CI:4.5, 28.8
Odds ratio between groups (95% CI) [#]	6.26 (2.3, 16.8)		6.14 (2.4, 15.8)		7.19 (2.3, 22.4) p<0.001		7.76 (2.7, 22.2) p<0.001	
CBR, n (%)	63 (86.3) 95% CI: 76.2, 93.2	16 (43.2) 95% CI:27.1, 60.5	67 (91.8) 95% CI:83.0, 96.9	21 (56.8) 95% CI:39.5, 72.9	63 (86.3) 95% CI:76.2, 93.2	17 (45.9) 95% CI:29.5, 63.1	67 (91.8) 95% CI:83.0, 96.9	22 (59.5) 95% CI:42.1, 75.2
Odds ratio between groups (95% CI) [#]	8.27 (3.3, 21.0)		8.51(3.0, 24.5)		7.41 (2.9,18.8) p<0.001		7.61(2.6, 22.0) p<0.001	
Duration of response								
No. of responders* n (%)	40 (54.8)	6 (16.2)	43 (58.9)	7 (18.9)	34 (46.6)	4 (10.8)	40 (54.8)	5 (13.5)
No. of events, n (%)	20 (50.0)	4 (66.7)	12 (27.9)	3 (42.9)	10 (29.4)	2 (50.0)	1 (2.5)	1 (20.0)
No. censored, n (%)	20 (50.0)	2 (33.3)	31 (72.1)	4 (57.1)	24 (70.6)	2 (50.0)	39 (97.5)	4 (80.0)
Reason for censoring								

	Final analysis data cut (28th April 2023)				Primary analysis data cut (23rd August 2021)			
	Independent Reviewer Assessment		Investigator Assessment		Independent Reviewer Assessment		Investigator Assessment	
	D+T (N=73) n (%)	C+V (N=37) n (%)	D+T (N=73) n (%)	C+V (N=37) n (%)	D+T (N=73) n (%)	C+V (N=37) n (%)	D+T (N=73) n (%)	C+V (N=37) n (%)
Ongoing without event ^a , n (%)	18 (45.0)	2 (33.3)	31 (72.1)	3 (42.9)	23 (67.6)	2 (50.0)	0	0
Initiation of new cancer therapy ^b , n (%)	1 (2.5)	0	0	0	1 (2.9)	0	0	0
Adequate assessment no longer available ^c , n (%)	1 (2.5)	0	0	1 (14.3)	0	0	0	0
Time to response (months)								
No. of responders, n*	40	6	43	7	34	4	40	5
Mean (SD)	5.3 (3.86)	6.2 (3.19)	5.1 (5.45)	7.0 (6.08)	4.3 (2.65)	4.2 (0.74)	4.0 (3.42)	4.2 (1.86)
Median	3.7	4.6	3.4	5.7	3.6	3.8	2.8	3.8
Min, max	1.6, 16.3	3.7, 11.1	1.4, 27.3	1.7, 20.0	1.6, 13.0	3.7, 5.3	1.4, 20.4	1.7, 6.4
Median DOR, months (95% CI)	30.0 (16.6, NE)	19.4 (6.6, NE)	44.4 (33.1, NE)	22.5 (5.3, NE)	20.3 (12.0, NE)	NE (6.6, NE)	NE (25.5, NE)	NE (5.3, NE)
KM event-free estimates %, (95% CI)								
6 months	85.0 (69.6, 93.0)	100.0 (100.0, 100.0)	97.7 (84.6, 99.7)	85.7 (33.4, 97.9)	85.7 (66.3, 94.4)	100.0 (100.0, 100.0)	100.0 (100.0, 100.0)	80.0 (20.4, 96.9)
12 months	74.8 (58.2, 85.6)	66.7 (19.5, 90.4)	95.3 (82.5, 98.8)	85.7 (33.4, 97.9)	70.1 (46.2, 84.9)	50.0 (5.8, 84.5)	100.0 (100.0, 100.0)	80.0 (20.4, 96.9)
24 months	55.9 (37.7, 70.7)	44.4 (6.6, 78.5)	87.5 (72.4, 94.6)	45.7 (6.9, 79.5)	46.4 (20.6, 68.9)	NE (NE, NE)	100.0 (100.0, 100.0)	NE (NE, NE)
30 months	44.8 (25.2, 62.7)	NE (NE, NE)	75.9 (56.6, 87.5)	45.7 (6.9, 79.5)	-	-	-	-
No. of PFS events – n (%)	44 (60.3)	26 (70.3)	23 (31.5)	15 (40.5)	30 (41.1)	22 (59.5)	9 (12.3)	9 (24.3)
Progression, n (%)	44 (60.3)	26 (70.3)	23 (31.5)	15 (40.5)	30 (41.1)	22 (59.5)	9 (12.3)	9 (24.3)

	Final analysis data cut (28th April 2023)				Primary analysis data cut (23rd August 2021)			
	Independent Reviewer Assessment		Investigator Assessment		Independent Reviewer Assessment		Investigator Assessment	
	D+T (N=73) n (%)	C+V (N=37) n (%)	D+T (N=73) n (%)	C+V (N=37) n (%)	D+T (N=73) n (%)	C+V (N=37) n (%)	D+T (N=73) n (%)	C+V (N=37) n (%)
Death, n (%)	0	0	0	0	0	0	0	0
No. censored, n (%)	29 (39.7)	11 (29.7)	50 (68.5)	22 (59.5)	43 (58.9)	15 (40.5)	64 (87.7)	28 (75.7)
Median PFS, months (95% CI)	24.9 (12.9, 31.6)	7.2 (2.8, 11.2)	46.0 (38.6, NE)	30.8 (7.0, NE)	20.1 (12.8, NE)	7.4 (3.6, 11.8)	NE (NE, NE)	NE (12.6, NE)
KM event-free estimates % (95%CI)								
12 months	67.7 (55.5, 77.2)	27.4 (13.0, 43.9)	90.3 (80.7, 95.3)	67.9 (48.4, 81.3)	66.6 (53.2, 77.0)	26.1 (9.9, 45.9)	91.2 (81.3, 96.0)	73.7 (54.0, 85.9)
24 months	52.0 (39.8, 62.9)	20.5 (8.4, 36.4)	83.3 (72.4, 90.1)	60.7 (41.1, 75.5)	37.9 (20.0, 55.8)	NE (NE, NE)	85.3 (71.5, 92.8)	68.0 (46.4, 82.4)
36 months	37.4 (24.9, 49.9)	NE (NE, NE)	65.9 (51.2, 77.1)	44.6 (23.6, 63.7)				
48 months	26.7 (12.9, 42.7)	NE (NE, NE)	44.9 (21.0, 66.4)	44.6 (23.6, 63.7)				
Cox model HR (95% CI)	0.36 (0.22, 0.59)		0.46 (0.24, 0.88)		0.31 (0.17, 0.55) P<0.001 [^]		0.37 (0.14, 0.93)	

Event: progression disease or death due to any cause.

[^]Log-rank test at an overall one-sided 2.5% level of significance.

[#]Odds ratio (D+T vs C+V) and 95% confidence interval are from a logistic regression with treatment as the only covariate. Odds ratio > 1 favours D+T

[†]Patients with BOR of confirmed CR or PR;

^{*}Patients without event and who had adequate follow-up as of DCO;

[‡]If the time interval was larger than the interval of two missing tumour assessments with no event observed or without adequate baseline assessments

ORR = (CR+PR)

CBR = CR+PR+stable disease)

Abbreviations: BOR, best overall response; C, carboplatin; CBR, clinical benefit rate; CI, confidence interval; CR, complete response; CRF, case report form; D, dabrafenib; DOR, duration of response FAS, full analysis set; HR, hazard ratio; KM, Kaplan-Meier; LGG, low-grade glioma; NE, not estimable; OR, odds ratio; ORR, overall response rate; PD, progressive disease; PFS, progression-free survival; PR, partial response; RANO, Response-Assessment for Neuro-Oncology; SD, standard deviation; T, trametinib; V, vincristine.

Health Related Quality of Life (HRQoL) was assessed using the PROMIS Parent Proxy Global Health 7+2.³⁰ Among patients taking the PROMIS³⁰ parent proxy questionnaire, $\geq 82\%$ in the D+T arm and $\geq 72\%$ in the C+V arm fully completed the questionnaire at the scheduled time points, during the treatment period (final analysis data cut). It is unclear to the EAG if any missing data were at random.

The treatment difference in the overall least-squares means (LSM) of scores between the two groups for global health and fatigue favoured D+T over C+V at all scheduled time points. Outcomes on the pain subscale were similar in the two treatment arms. A summary of these results is provided in Table 10 (further details are provided in CS², page 55). In agreement with the FDA's assessment,³⁹ the EAG notes that this data are exploratory and should be used with caution.

Table 10: PROMIS Parent Proxy Global Health³⁰ – Repeated measures analysis, FAS-LGG (reproduced from CS², Table 14)

Time point	Statistics	D+T N=73	C+V N=37	LSM difference [A-B]
Global health scores				
Week 5 Day 1	N	50	18	–
	LSM (SEM)	42.932 (1.0157)	39.501 (1.6726)	3.431 (1.9569)
	95% CI	40.908, 44.957	36.169, 42.833	–0.468, 7.330
Week 8 Day 1	N	53	18	–
	LSM (SEM)	43.931 (0.9684)	38.093 (1.6261)	5.838 (1.8927)
	95% CI	42.003, 45.859	34.857, 41.328	2.072, 9.605
Week 16 Day 1	N	48	10	–
	LSM (SEM)	44.415 (1.0842)	36.552 (2.1124)	7.863 (2.3743)
	95% CI	42.248, 46.582	32.345, 40.759	3.132, 12.594
Week 24 Day 1	N	46	10	–
	LSM (SEM)	45.819 (1.1657)	35.383 (2.3353)	10.436 (2.6101)
	95% CI	43.491, 48.147	30.733, 40.034	5.236, 15.635
Week 32 Day 1	N	47	11	–
	LSM (SEM)	45.571 (1.0551)	37.176 (2.0337)	8.396 (2.2910)
	95% CI	43.460, 47.682	33.119, 41.232	3.824, 12.968
Week 48 Day 1	N	43	10	–
	LSM (SEM)	44.854 (1.1200)	37.333 (2.1854)	7.521 (2.4557)
	95% CI	42.616, 47.092	32.978, 41.688	2.626, 12.416
End of treatment	n	50	14	–
	LSM (SEM)	45.247 (1.2867)	38.754 (2.3377)	6.493 (2.6684)
	95% CI	42.683, 47.811	34.102, 43.406	1.182, 11.804
Pain scores				
Week 5 Day 1	n	51	18	–
	LSM (SEM)	50.410 (0.9680)	51.099 (1.6275)	–0.689 (1.8937)
	95% CI	48.479, 52.341	47.852, 54.345	–4.466, 3.088
Week 8 Day 1	n	54	18	–
	LSM (SEM)	49.899 (0.8946)	50.254 (1.5573)	–0.356 (1.7957)
	95% CI	48.116, 51.681	47.152, 53.357	–3.933, 3.222
Week 16 Day 1	n	48	10	–
	LSM (SEM)	50.201 (0.9156)	50.879 (1.9848)	–0.678 (2.1865)
	95% CI	48.369, 52.034	46.912, 54.846	–5.048, 3.693
Week 24 Day 1	n	46	10	–
	LSM (SEM)	50.456 (1.0228)	51.313 (2.0596)	–0.857 (2.2994)
	95% CI	48.414, 52.498	47.211, 55.415	–5.439, 3.725
Week 32 Day 1	N	47	11	–
	LSM (SEM)	48.948 (0.9346)	49.042 (1.9001)	–0.094 (2.1176)

Time point	Statistics	D+T N=73	C+V N=37	LSM difference [A-B]
	95% CI	47.079, 50.817	45.244, 52.839	-4.326, 4.139
Week 48 Day 1	N	43	10	-
	LSM (SEM)	49.734 (0.9006)	51.182 (1.8181)	-1.449 (2.0299)
	95% CI	47.931, 51.536	47.547, 54.818	-5.508, 2.610
End of treatment	N	50	14	-
	LSM (SEM)	51.530 (0.9384)	53.341 (1.7562)	-1.811 (1.9910)
	95% CI	49.656, 53.404	49.836, 56.845	-5.785, 2.163
Fatigue scores				
Week 5 Day 1	N	51	18	-
	LSM (SEM)	53.733 (0.9113)	56.220 (1.5076)	-2.487 (1.7622)
	95% CI	51.916, 55.549	53.217, 59.223	-5.998, 1.024
Week 8 Day 1	N	54	18	-
	LSM (SEM)	52.989 (0.8296)	57.870 (1.3985)	-4.881 (1.6266)
	95% CI	51.336, 54.642	55.086, 60.653	-8.120, -1.642
Week 16 Day 1	N	48	10	-
	LSM (SEM)	51.798 (0.8567)	58.429 (1.7315)	-6.632 (1.9323)
	95% CI	50.087, 53.508	54.983, 61.876	-10.479, -2.784
Week 24 Day 1	N	46	10	-
	LSM (SEM)	51.746 (1.0240)	55.320 (2.1144)	-3.574 (2.3500)
	95% CI	49.699, 53.794	51.102, 59.539	-8.263, 1.116
Week 32 Day 1	N	47	11	-
	LSM (SEM)	52.931 (0.8658)	57.677 (1.7390)	-4.746 (1.9441)
	95% CI	51.200, 54.661	54.204, 61.149	-8.628, -0.864
Week 48 Day 1	N	43	10	-
	LSM (SEM)	52.602 (1.0222)	53.994 (2.0715)	-1.392 (2.3120)
	95% CI	50.555, 54.648	49.850, 58.138	-6.017, 3.233
End of treatment	N	50	14	-
	LSM (SEM)	52.022 (0.9079)	56.582 (1.6961)	-4.559 (1.9236)
	95% CI	50.210, 53.835	53.198, 59.965	-8.397, -0.721

Data cut: Final analysis data cut, 28th April 2023.

Mixed effects model includes terms for treatment, visit and baseline score as main effects and an interaction term for visit and treatment; The analysis only includes assessment time points where there are at least 10 evaluable patients on each of the treatment arms.

Abbreviations: C, carboplatin; CI, confidence interval; D, dabrafenib; FAS, full analysis set; LGG, low-grade glioma; LSM, least squares mean; PROMIS, Patient Reported Outcomes Measurement Information Service; SEM, standard error of the mean; T, trametinib; V, vincristine.

3.2.6.1.3 Subgroup analysis

The company undertook a sub-group analysis to assess radiographic progression in D+T vs C+V. Where radiographic progression was used as an indicator to treatment, the ORR was [REDACTED] in the D+T arm vs [REDACTED] in the C+V arm (OR: [REDACTED], 95% CI: [REDACTED]). Where radiographic progression was not used as indication to treatment, the ORR was [REDACTED] in D+T vs [REDACTED] in C+V (OR: [REDACTED], 95% CI: [REDACTED]). Although the ORR demonstrated results in favour of the D+T arm over the C+V arm, this should be interpreted with caution as all subgroup analyses were exploratory, and the studies were not powered for these assessments. Furthermore, the number of patients with gross total resection was very low (n=[REDACTED]), and [REDACTED] patients were in the D+T arm.

3.2.6.1.4 Safety and tolerability

This section provides the main safety evidence for the use of D+T in patients with LGG available from the TADPOLE LGG RCT.¹¹ Safety was evaluated in patients who received at least one dose of study treatment. The safety of D+T was compared to C+V by assessing AEs, SAEs, and AEs leading to discontinuation in the LGG cohort. In the CS,² it was not clear how grading of the AEs was determined but in the response to clarification (question A13),¹⁶ it has been reported that “Adverse events were assessed and graded according to the Common Terminology Criteria for Adverse Events (CTCAE) version 4.03. Grades were used to characterise the severity of the adverse event.”

An overview of the safety results from the final analysis data cut of TADPOLE LGG RCT¹¹ is presented in Table 11. Patients in the D+T arm continued to receive treatment until disease progression, while patients in the C+V arm received one course of induction (10 weeks of chemotherapy with 2 weeks of rest), followed by up to 8 cycles of maintenance chemotherapy (each maintenance cycle was 6 weeks). A total of 89.0% of patients received D+T for 56 weeks or longer and 72.6% of patients received D+T for at least 112 weeks. 45.5% of patients received carboplatin and 42.4% of patients received vincristine for at least 56 weeks. The EAG believes that the duration of exposures to D+T was appropriate to allow for an adequate assessment of safety in patients. However, the CS² does not state how long patients are going to be on D+T treatment so if patients need to take the drug for a longer time period, it is not clear how this will impact the safety assessment.

In the LGG cohort, all patients in both arms experienced at least one AE. The most frequently reported treatment related AEs, occurring in $\geq 30\%$ of patients in either arm (D+T vs C+V) were pyrexia ([REDACTED]), vomiting ([REDACTED]), nausea ([REDACTED]), neutrophil count decreased ([REDACTED]), white blood cell (WBC) count decreased ([REDACTED]), anaemia ([REDACTED]), constipation ([REDACTED]), neutropenia ([REDACTED]), and platelet count decreased ([REDACTED]). The proportion of patients experiencing treatment related Grade ≥ 3 AEs

were lower in the D+T arm compared with the C+V arm (██████████). The most frequently reported SAEs and Grade \geq 3 SAEs, occurring in over 3% of patients, were pyrexia (██████% vs ██████%), and tonsillitis and vomiting (both ██████████%). Their incidence was mostly higher in D+T arm though there was not a statistically significant difference between the groups (See CS², Document B, Table 31).

3.2.6.1.4.1 Dose adjustments and treatment discontinuation

For patients who did not tolerate the protocol-specified dosing schedule, dosing adjustments were done to allow patients to continue the study treatment. A narrative explanation of AEs leading to dose adjustment/interruption in the final analysis data cut have not been provided in the CS.² However, as reported in Appendix F, Table 12, the number of patients with AEs and Grade \geq 3 AEs leading to dose adjustment and/or interruption were similar in both treatment arms. In total, ██████████ patients in D+T arm and ██████████ patients in C+V arm experienced AEs leading to dose adjustment/interruption and ██████████ patients in D+T arm and 19 ██████████ patients in C+V arm experienced Grade \geq 3 AEs leading to dose adjustment/interruption. However, the risk difference between the groups for all grades pyrexia (██████████), COVID-19 (██████████), weight increased (██████████), diarrhoea and headache (██████████) were significantly higher AEs leading to dose adjustment and/or interruption in D+T arm and the risk difference between the groups for neutrophil count decreased (██████████), platelet count decreased (██████████), infusion-related reaction, peripheral sensory neuropathy, and thrombocytopenia (██████████) were significantly higher in C+V arm. In addition, a total of 36 patients (32.7%) in the LGG cohort discontinued treatment; mostly due to disease progression (38.9%). The proportion of patients discontinuing due to progressive disease was higher in the C+V arm than in the D+T arm (27.0% vs 5.5%).

Discontinuations due to AEs were almost five times as frequent in the C+V arm 21.6% (8/37) compared with the D+T arm 4.1% (4/73) in the LGG cohort and all AEs leading to treatment discontinuation was treatment related in both arms. It has been reported that 11 patients (10.0%) discontinued due to AE (three patients [4.1%] in the D+T arm vs eight patients [21.6%] in the C+V arm). (See CS², Document B, Section B.2.6.1.1.)” However, there was a mismatch in reporting the number of patients discontinuing treatment in D+T arm in LGG cohort as in another Section (see CS², Section B.2.10.1.6.), it is reported that “In total, four patients (5.5%) receiving D+T experienced an adverse event leading to treatment discontinuation, compared with eight patients (24.2%) in the C+V arm (Table 32)”.

3.2.6.1.4.2 Death

No fatal adverse events were reported in either treatment arm. No deaths in the D+T arm and one death in the C+V arm has been reported in the LGG cohort. This death has not been found to be treatment

Confidential until published

related and as reported in the company's response to clarification (question A10),¹⁶ "*One death, due to underlying disease, was reported in the C+V arm.*" Overall, considering the reported AEs data, D+T treatment appears to have an acceptable safety profile in the LGG cohort.

Table 11: Overview of AEs in LGG cohort (reproduced from CS², Document B, Table 28)

	LGG Cohort					
	D+T N=73		C+V N=33		D+T vs C+V risk difference (95%CI)	
	All Grades n (%)	Grade ≥3 n (%)	All grades n (%)	Grade ≥3 n (%)	All grades	Grade ≥3
AEs	<u>73 (100.0)</u>	<u>39 (53.4)</u>	<u>33 (100.0)</u>	<u>31 (93.9)</u>	<u>NE (NE, NE)</u>	<u>-40.5 (-54.6, -26.5)</u>
Treatment-related	<u>68 (93.2)</u>	<u>23 (31.5)</u>	<u>32 (97.0)</u>	<u>29 (87.9)</u>	<u>-3.8 (-12.1, 4.4)</u>	<u>-56.4 (-71.8, -41.0)</u>
SAEs	<u>34 (46.6)</u>	<u>26 (35.6)</u>	<u>14 (42.4)</u>	<u>8 (24.2)</u>	<u>4.2 (-16.2, 24.5)</u>	<u>11.4 (-6.9, 29.7)</u>
Treatment-related	<u>11 (15.1)</u>	<u>7 (9.6)</u>	<u>9 (27.3)</u>	<u>5 (15.2)</u>	<u>-12.2 (-29.5, 5.1)</u>	<u>-5.6 (-19.5, 8.4)</u>
Fatal SAEs	<u>0 (0.0)</u>	<u>0 (0.0)</u>	<u>0 (0.0)</u>	<u>0 (0.0)</u>	<u>NE</u>	<u>NE</u>
Treatment-related	<u>0 (0.0)</u>	<u>0 (0.0)</u>	<u>0 (0.0)</u>	<u>0 (0.0)</u>	<u>NE</u>	<u>NE</u>
AEs leading to discontinuation	<u>4 (5.5)</u>	<u>3 (4.1)</u>	<u>8 (24.2)</u>	<u>3 (9.1)</u>	<u>-18.8 (-34.3, -3.2)</u>	<u>-5.0 (-15.8, 5.8)</u>
Treatment-related	<u>4 (5.5)</u>	<u>3 (4.1)</u>	<u>8 (24.2)</u>	<u>3 (9.1)</u>	<u>-18.8 (-34.3, -3.2)</u>	<u>-5.0 (-15.8, 5.8)</u>
AEs leading to dose adjustment/interruption	<u>61 (83.6)</u>	<u>33 (45.2)</u>	<u>26 (78.8)</u>	<u>19 (57.6)</u>	<u>4.8 (-11.6, 21.1)</u>	<u>-12.4 (-32.7, 8.0)</u>
AEs requiring additional therapy	<u>73 (100.0)</u>	<u>28 (38.4)</u>	<u>33 (100.0)</u>	<u>22 (66.7)</u>	<u>NE (NE, NE)</u>	<u>-28.3 (-47.9, -8.7)</u>

Data cut: Final analysis data cut, 28th April 2023.

A patient with multiple severity grades for an AE is only counted under the maximum grade.

MedDRA version 24.0, CTCAE version 4.03.

Abbreviations: AE, adverse event; C, carboplatin; CI, confidence interval; CTCAE, Common Terminology Criteria for Adverse Events; D, dabrafenib; HGG, high-grade glioma; LGG, low-grade glioma; MedDRA, Medical Dictionary for Regulatory Activities; NE, not estimable; SAE, serious adverse event; T, trametinib; V, vincristine

3.2.6.2 HGG prospective cohort study

3.2.6.2.1 Demographics and baseline characteristics

In total, 46 patients were screened for entry into the HGG cohort, of whom 41 patients entered the study upon completion of the screening phase. The demographic and baseline characteristics of patients in the HGG cohort are presented in

Table 12 reproduced from the CS,² page 47, Table 9. The median age of patients was 13 years (range, 2.0-17.0) and there were more female than male patients (56.1% vs 43.9%) with majority of patients being White (61.0%). Five patients (12.2%) had a KPS/LPS³² score <70. The median time since initial diagnosis to study entry was 17.4 months (range: 2.7–174.3) and the median time since last recurrence/progression to study entry was 1.7 months (range: 0.3–18.2).

All patients had received at least one form of prior therapy, and at initial diagnosis per investigator assessment, 20 patients (48.8%) had Grade IV gliomas and 13 patients (31.7%) had Grade III gliomas by WHO 2016 criteria.²⁸ Seven patients had initial diagnoses of Grade I or Grade II gliomas and subsequently transformed into HGG prior to study entry. All patients had gliomas with BRAF V600E mutation. At the time of diagnosis, the most common tumour histology types were glioblastoma multiforme (31.7%), anaplastic pleomorphic xanthoastrocytoma (14.6%), HGG not otherwise specified (9.8%), pleomorphic xanthoastrocytoma (9.8%), and anaplastic astrocytoma (7.3%). Of the 35 patients with available molecular data, 23 (65.7%) had homozygous deletion of CDKN2A/B, 3 (8.6%) had histone H3K27M mutations, and 6 (17.1%) had TP53 alterations.⁴⁰ Homozygous CDKN2A/B deletion has been identified as a favourable prognostic factor in paediatric HGG.⁴¹

It is also worth noting that paediatric patients with H3-mutant HGG generally have worse prognosis than those with wild-type disease.⁴² In addition, the study inclusion was based on the WHO 2016 classification system²⁸ instead of the latest 2021 version of the classification, which incorporates both histologic and molecular features.⁴³ As reported in the FDA assessment report,³⁹ all patients had received at least 1 concomitant medication during the study. The most commonly administered concomitant medications (used in $\geq 20\%$ of patients) were paracetamol (65.9%), levetiracetam (39.0%), dexamethasone (36.6%), ondansetron (31.7%), and ibuprofen (22.0%).

Table 12: Demographics and baseline disease characteristics, FAS-HGG (reproduced from CS², page 47, Table 9)

	All patients N=41
Demographics	
Age (years)	
Mean (SD)	12.12 (4.451)
Median	13.00
Q1–Q3	10.00–16.00
Min, Max	2.0, 17.0
Age category, n (%)	
12 months–<6 years	5 (12.2)
6–<12 years	10 (24.4)
12–<18 years	26 (63.4)
Sex, n (%)	
Female	23 (56.1)
Male	18 (43.9)
Race, n (%)	
White	25 (61.0)
Asian	11 (26.8)
Black or African American	1 (2.4)
Unknown	3 (7.3)
Not reported	1 (2.4)
Ethnicity, n (%)	
Not Hispanic or Latino	26 (63.4)
Hispanic or Latino	5 (12.2)
Unknown	3 (7.3)
Not reported	7 (17.1)
Weight (kg)	
Mean (SD)	49.82 (27.381)
Median	44.90
Q1–Q3	33.20–57.40
Min, Max	11.3, 155.6
BMI (kg/m ²)	
No. of patients	40
Mean (SD)	20.58 (7.390)
Median	18.34
Q1–Q3	16.58–21.55
Min, Max	10.4, 48.8
Lansky and Karnofsky performance status, n (%)	
100	15 (36.6)

	All patients N=41
90	13 (31.7)
80	7 (17.1)
70	1 (2.4)
<70	5 (12.2)
Baseline disease characteristics	
Pathology at initial diagnosis, n (%)	
Anaplastic astrocytoma	3 (7.3)
Anaplastic ganglioglioma	2 (4.9)
Anaplastic pilocytic astrocytoma	1 (2.4)
Anaplastic pleomorphic xanthoastrocytoma	6 (14.6)
Diffuse midline glioma (H3K27M Mutated)	2 (4.9)
Diffuse midline glioma, NOS	1 (2.4)
Epithelioid glioblastoma multiforme	1 (2.4)
Ganglioglioma	1 (2.4)
Glioblastoma multiforme	13 (31.7)
HGG, NOS	4 (9.8)
LGG, NOS	1 (2.4)
Oligodendroglioma	1 (2.4)
Pleomorphic Xanthoastrocytoma	4 (9.8)
Unknown	1 (2.4)
Histological grade at initial diagnosis, n (%)	
Grade I	3 (7.3)
Grade II	4 (9.8)
Grade III	13 (31.7)
Grade IV	20 (48.8)
Missing	1 (2.4)
Time since initial diagnosis of primary site to study entry (months)	
Mean (SD)	30.5 (38.89)
Median	17.4
Q1–Q3	8.3–30.4
Min, Max	2.7, 174.3
<i>BRAF</i> mutation status [†]	
V600E	41 (100)
Time from initial diagnosis to first recurrence/progression (months)	
No. of patients	21
Mean (SD)	16.0 (19.56)
Median	10.9
Min, Max	3.5, 73.5
Time since last recurrence/progression to study entry (months)	
No. of patients	7

	All patients N=41
Mean (SD)	4.6 (6.37)
Median	1.7
Min, Max	0.3, 18.2

Note: Presence/absence of target and non-target lesions based on the data collected on RANO target/non-target lesion assessment eCRF pages.

†Local *BRAF* is presented when available otherwise central *BRAF* is presented. Five patients were enrolled with central *BRAF* status.

Abbreviations: BMI, body mass index; BRAF, v-raf murine sarcoma viral oncogene homolog B; BSA, body surface area; C, carboplatin; D, dabrafenib; eCRF, electronic case report form; FAS, full analysis set; HGG, high-grade glioma; NOS, not otherwise specified; Q, quartile; RANO, Response-Assessment for Neuro-Oncology; SD, standard deviation; T, trametinib; V, vincristine.

As of the final analysis DCO (the 28th of April 2023), in patients with HGG, 17/41 patients (41.5%) had completed treatment. The median duration of exposure to both dabrafenib and trametinib was 121.1 weeks (range: 1.3–213.4). A total of 63.5% of patients received D+T for ≥ 56 weeks and 53.7% patients received D+T for at least 112 weeks. Twenty-four patients (58.5%) discontinued treatment; the primary reason was reported as progressive disease in 19 patients (46.3%), while two patients died, two patients discontinued due to the physician's decision, and one patient discontinued due to an AE. A large portion of HGG patients, 88.3% (28/41) required dose adjustment/interruption due to AEs.

3.2.6.2.2 Efficacy results

In brief, the CS² states that the primary analysis in the HGG cohort was performed on the FAS. The efficacy results for the HGG cohort by the independent reviewer and investigate reviewer at both the primary analysis data cut (23rd of August 2021) and the final analysis data cut (28th of April 2023) are presented in Table 13. Results by the independent reviewer from the final analysis cut are summarised below. Overall, there were no major concerns regarding the efficacy data between the different data cut and between the reviewers.

The primary endpoint, ORR per blinded independent review using the RANO criteria^{26, 27} was 56.1% (95% CI: 39.7, 71.5; 80% CI: 44.9, 66.8). Similarly, the ORR by investigator assessment was 61.0% (95% CI: 44.5, 75.8; 80% CI: 49.8, 71.3), The concordance of ORR between the independent review and local investigator assessment was 75.6% (31/41). CR was reported in 14 patients (34.1%) and PR in nine patients (22.0%). The CBR (CR+PR+SD) was 65.9% (95% CI: 49.4, 79.9). It should be noted CBR is not considered to be a clinically relevant endpoint for efficacy evaluation by the FDA assessment.³⁹ However, the FDA agrees with the analysis of the primary endpoint of ORR determined by blinded independent review per RANO criteria.^{26, 27}

Using descriptive statistics, among patients with confirmed response (CR or PR), the median TTR by independent reviewer was 1.9 months (range: 1.0, 10.9). In the 23 responders the median DOR was 27.4 months (95% CI: 9.2, NE) and observed responses were durable with 52.2% (12/23) patients continued to be in response at the time of the final data cut. The KM-estimated 12-month event-free rate (i.e., the proportion of responders still in response) was 63.3% (95% CI: 39.8, 79.7) and at 30 months 45.1% (95% CI: 22.0, 65.7). Further details are provided in Table 9 including reasons for censoring. The CS² did not report response data observed across the different histologic subtypes and molecular profiles. However, Hargraves *et al.*,⁴⁰ reported that independently reviewed responses using RANO criteria^{26,27} were observed across most histologic subtypes and molecular profiles, including in patients with H3K27M (1/3) and CDKN2A/B (13/23) mutations.

CS² reported that at the time of final analysis data cut, median PFS was 9.0 months (95% CI: 5.3, 20.1) by independent review, 27 patients (65.9%) had a PFS event including 24 patients (58.5%) with disease progression and three patients (7.3%) who died before documented disease progression (one due to HGG and two due to SAEs that were not treatment-related per investigators). KM-estimated 6-month and 12-month event-free rates were 67.0% (95% CI: 49.9, 79.3) and 45.5% (95% CI: 29.4, 60.3), respectively. The OS data were immature at the time of the final analysis. Among the 41 patients, 17 patients (41.5%) died, and 24 patients (58.5%) were censored at the time of the final data cut. The estimated OS rates at 12 and 24 months were 77.0% (95% CI: 60.4, 87.3) and 61.0% (95% CI: 43.8, 74.4), respectively. The EAG notes that time-to-event endpoints such as PFS and OS, are not interpretable in absence of a comparator arm and therefore should be considered descriptive only. The KM methods used to estimate response duration, PFS, OS and TTR by the independent reviewer are presented on page 60, Figure 10, page 62, Figure 12, and page 64, Figure 14 of the CS,² respectively.

Table 13: Efficacy results for the TADPOLE HGG cohort using RANO criteria^{26, 27} on full analysis set (reproduced from CS², Table 15, Table 16, Table 17, Table 18 and Table 19)

Estimates	Final analysis data cut (28th April 2023)		Primary analysis data cut (23rd August 2021)	
	All patients (N=41)		All patients (N=41)	
	Independent review	Investigator assessment	Independent review	Investigator assessment
Best overall response, n (%)				
CR, n (%)	14 (34.1)	12 (29.3)	12 (29.3)	10 (24.4)
PR, n (%)	9 (22.0)	13 (31.7)	11 (26.8)	14 (34.1)
Stable disease, n (%)	5 (12.2)	6 (14.6)	5 (12.2)	7 (17.1)
PD, n (%)	10 (24.4)	9 (22.0)	10 (24.4)	9 (22.0)
Unknown, n (%)	3 (7.3)	1 (2.4)	3 (7.3)	1 (2.4)
ORR:CR+PR, n (%)	23 (56.1)	25 (61.0)	23 (56.1)	24 (58.5)
95% CI/80% CI	39.7, 71.5/44.9, 66.8	(44.5, 75.8)/(49.8, 71.3)	39.7, 71.5/44.9, 66.8	42.1, 73.7/47.3, 69.1
CBR:CR+PR+SD, n (%)	27 (65.9)	31 (75.6)	27 (65.9)	30 (73.2)
95% CI/80% CI	49.4, 79.9/NA	(59.7, 87.6)/NA	49.4, 79.9/NA	57.1, 85.8/NA
No. of responders*, n (%)	23 (56.1)	25 (61.0)	23 (56.1)	24 (58.5)
No. of events, n (%)	11 (47.8)	12 (48.0)	8 (34.8)	8 (33.3)
No. of censored, n (%)	12 (52.2)	13 (52.0)	15 (65.2)	16 (66.7)
Reason for censoring				
Ongoing without event ^a	9 (39.1)	11 (44.0)	0	15 (62.5)
Initiation of new cancer therapy	2 (8.7)	2 (8.0)	0	1 (4.2)
Adequate assessment no longer available ^b	1 (4.3)	0	0	0
Time to response (months) responders only				
No. of responders*, n (%)	23 (56.1)	25 (61.0)	23 (56.1)	24 (58.5)
Mean (SD)	3.3 (2.76)	3.1 (4.45)	3.3 (2.76)	2.2 (1.24)
Median (min-max)	1.9 (1.0, 10.9)	1.7 (0.9, 23.6)	1.9 (1.0, 10.9)	1.7 (0.9, 5.6)
Median DOR, months (95% CI)	27.4 (9.2, NE)	32.7 (14.9, NE)	22.2 (7.6, NE)	26.6 (14.9, NE)
KM event-free estimates %, (95% CI)				
6 months	86.4 (63.4, 95.4)	91.7 (70.6, 97.8)	84.7 (59.7, 94.8)	95.7 (72.9, 99.4)

Estimates	Final analysis data cut (28th April 2023)		Primary analysis data cut (23rd August 2021)	
	All patients (N=41)		All patients (N=41)	
	Independent review	Investigator assessment	Independent review	Investigator assessment
12 months	63.3 (39.8, 79.7)	82.9 (60.7, 93.2)	62.2 (36.3, 80.0)	81.7 (58.2, 92.7)
24 months	52.6 (29.5, 71.3)	64.5 (41.3, 80.5)	49.8 (20.8, 73.4)	56.9 (26.6, 78.6)
30 months	45.1 (22.0, 65.7)	59.5 (36.4, 76.6)	49.8 (20.8, 73.4)	28.4 (1.8, 67.6)
No. of PFS events, n (%)	27 (65.9)	24 (58.5)	24 (58.5)	20 (48.8)
Progression, n (%)	24 (58.5)	23 (56.1)	21 (51.2)	19 (46.3)
Death, n (%)	3 (7.3)	1 (2.4)	3 (7.3)	1 (2.4)
No. censored, n (%)	14 (34.1)	17 (41.5)	17 (41.5)	21 (51.2)
PFS, months (95% CI)	9.0 (5.3, 20.1)	24.0 (12.5, NE)	9.0 (5.3, 24.0)	17.1 (12.5, NE)
KM event-free estimates % (95% CI)				
6 months	67.0 (49.9, 79.3)	70.3 (53.6, 81.9)	66.8 (49.6, 79.2)	72.7 (56.1, 83.9)
12 months	45.5 (29.4, 60.3)	67.8 (51.1, 79.9)	44.1 (27.8, 59.3)	67.4 (50.5, 79.7)
24 months	34.1 (19.6, 49.3)	52.3 (35.8, 66.4)	34.4 (17.9, 51.6)	49.8 (31.7, 65.6)
36 months	27.4 (13.9, 42.8)	40.4 (24.6, 55.6)	27.5 (11.4, 46.5)	21.4 (1.9, 54.9)
OS, n (%)				
No. of deaths, n (%)	17 (41.5)	-	14 (34.1)	-
No. censored, n (%)	24 (58.5)	-	27 (65.9)	-
Median OS (95% CI)	NE (19.8, NE)	-	32.8 (19.2, NE)	-
KM event-free estimates % (95% CI)				
12 months	77.0 (60.4, 87.3)	-	76.3 (59.3, 86.9)	-
24 months	61.0 (43.8, 74.4)	-	58.6 (37.6, 74.7)	-
36 months	55.1 (37.9, 69.4)	-	39.1 (9.5, 68.7)	-
42 months	55.1 (37.9, 69.4)	-	NR	-

Event: progression disease or death due to any cause.

[†]Log-rank test at an overall one-sided 2.5% level of significance.

[#]Odds ratio (D+T vs C+V) and 95% confidence interval are from a logistic regression with treatment as the only covariate. Odds ratio > 1 favours D+T

^{*}Patients with BOR of confirmed CR or PR;

[‡]Patients without event and who had adequate follow-up as of DCO;

[§]If the time interval was larger than the interval of two missing tumour assessments with no event observed or without adequate baseline assessments

ORR = (CR+PR)

CBR = CR+PR+stable disease)

Abbreviations: BOR, best overall response; C, carboplatin; CBR, clinical benefit rate; CI, confidence interval; CR, complete response; CRF, case report form; D, dabrafenib; DOR, duration of response FAS, full analysis set; HGG, high-grade glioma HR, hazard ratio; KM, Kaplan-Meier; NE, not estimable; OR, odds ratio; ORR, overall response rate; PD, progressive disease; PFS, progression-free survival; PR, partial response; RANO, Response-Assessment for Neuro-Oncology; SD, standard deviation; T, trametinib; V, vincristine.

3.2.6.2.3 Safety and tolerability

This section provides the main safety evidence for the use of D+T in patients with HGG available from a single arm TADPOLE HGG cohort study (N=41).¹¹ An overview of the safety results from the final analysis data cut is presented in Table 13. A total of 63.5% of patients received D+T for ≥ 56 weeks and 53.7% patients received D+T for at least 112 weeks (CS², Document B, P.82). The CS² was discrepant in reporting the duration of exposure. In the (CS², Appendix F), Table 14, it is shown that 22 (53.7%) patients received D+T for ≥ 56 weeks and 2 (4.9%) patients received D+T for at least 112 weeks. However, the EAG believes that the first statement (i.e., 63.5% and 53.7% of patients) to be closer to the truth based on the PFS and TTD curves.

At least one AE was reported in all patients and 30 (73.2%) patients experienced Grade ≥ 3 AEs. The most frequently reported AEs (occurring in $\geq 15\%$ of patients) were pyrexia (53.7%), headache (46.3%), dry skin (34.1%), vomiting (29.3%), nausea (26.8%), diarrhoea (24.4%), upper respiratory tract infection (24.4%), rash (22.0%), cough (17.1%), and neutropenia (17.1%). Treatment related AEs were reported in 35 patients (85.4%) with 12 patients (29.3%) experiencing Grade ≥ 3 AEs. The most frequently reported treatment related AEs occurring in $\geq 10\%$ were pyrexia (██████), dry skin (██████), rash (██████%), neutropenia, and rash maculo-papular (both ██████%). SAEs were reported in 28 patients (68.3%) of which 24 (58.5%) had Grade ≥ 3 SAEs. The most frequently reported SAEs (occurring in $\geq 3\%$ of patients) were headache and pyrexia (██████████).

3.2.6.2.3.1 Dose adjustment and treatment discontinuation

AEs leading to dose adjustment and/or interruption were reported in 28 patients (68.3%). Of those, 14 (34.1%) were due to Grade ≥ 3 AEs and the top two AEs leading to dose adjustment and/or interruption (occurring in $\geq 5\%$ of patients) were pyrexia (██████) and headache (██████). Forty patients experiencing AEs also required additional therapy.

In the final analysis data cut, a total of 24 patients (58.5%) discontinued treatment and it was reported that one of these AEs was treatment related. The CS² was discrepant in reporting the number of patients discontinuing treatment. In Section CS², B.2.6.1.2, it was reported that “...one patient discontinued due to an AE.” whereas in CS², Section B.2.10.2.6, it is reported that “██████ patients (██████) discontinued study treatment due to AEs of rash (Grade 1 in ██████ patient and unknown grade in the ██████████)”.

3.2.6.2.3.2 Death

It was reported that 17 patients (41.5%) died in total (see CS², Document B, p.30). Six of these were considered on-treatment deaths while three were reported during post-treatment follow-up and seven during survival follow-up (see CS², Document B, Section B.2.6.1.2). Among patients who died while

on treatment, four patients died due to disease progression and two were reported to be secondary to other causes (■■■ due to encephalomyelitis and ■■■ due to increased intracranial pressure). It has also been reported that three patients had fatal SAEs, but no further details were provided except reporting that ■■■ of the three patients who died due to disease progression also had a fatal AE (apnoea) (see CS² Document B, p.82). It should be noted that the sum of patients who died with given reasons is 16, but it was reported that a total of 17 patients died. Therefore, there is one missing reason for death.

Table 14 Overview of AEs in HGG cohort (Reproduced from the CS², Document B, Table 33)

	HGG Cohort		
	All patients N=41		
	All Grades n (%)	Grade ≥3 n (%)	Grade 5 n (%)
AEs	<u>41 (100.0)</u>	<u>30 (73.2)</u>	<u>3 (7.3)</u>
Treatment-related	<u>35 (85.4)</u>	<u>12 (29.3)</u>	<u>0 (0.0)</u>
SAEs	<u>28 (68.3)</u>	<u>24 (58.5)</u>	<u>3 (7.3)</u>
Treatment-related	<u>7 (17.1)</u>	<u>6 (14.6)</u>	<u>0 (0.0)</u>
Fatal SAEs	<u>3 (7.3)</u>	<u>3 (7.3)</u>	<u>3 (7.3)</u>
Treatment-related	<u>0 (0.0)</u>	<u>0 (0.0)</u>	<u>0 (0.0)</u>
AEs leading to discontinuation	<u>2 (4.9)</u>	<u>0 (0.0)</u>	<u>0 (0.0)</u>
Treatment-related	<u>1 (2.4)</u>	<u>0 (0.0)</u>	<u>0 (0.0)</u>
AEs leading to dose adjustment/interruption	<u>28 (68.3)</u>	<u>14 (34.1)</u>	<u>2 (4.9)</u>
AEs requiring additional therapy	<u>40 (97.6)</u>	<u>25 (61.0)</u>	<u>1 (2.4)</u>

Data cut: Final analysis data cut, 28th April 2023.

A patient with multiple severity grades for an AE is only counted under the maximum grade. MedDRA version 24.0, CTCAE version 4.03.

Abbreviations: AE, adverse event; CTCAE, Common Terminology Criteria for Adverse Events; HGG, high-grade glioma; MedDRA, Medical Dictionary for Regulatory Activities; SAE, serious adverse event.

3.2.6.3 Supportive evidence Phase 1/2 study (NCT02124772)²⁴ for LGG

3.2.6.3.1 Baseline and demographic characteristics

The baseline and demographic characteristics are provided in the CS², Appendix O, Table 1. In total, 36 patients with BRAF V600–mutant glioma received D+T: 16 in part C and 20 in part D. Apart from 2 patients in the Part C study who had HGG, the rest of the patient population was LGG and 5.6% had metastatic disease. All patients had prior therapy and 91.7% had prior systematic therapy. Median age was 10 (1.4-17) years and KPS/LPS > 70% in all patients. The median time since initial diagnosis was 40.1 (3.4-123.8) months and median duration of exposure to treatment was 24 months (2.1-52.5). Twenty-three (65%) patients entered the rollover study, and 13 patients withdrew from the study due to: lack of efficacy 1 (2.8%); withdrawn consent 2 (5.6%); investigator discretion 2 (5.6%); study completion 2 (5.6%) and AEs 6 (16.7%). AEs led to dose reduction, interruption, or discontinuation of D+T in 11 (31%), 26 (72%), and 8 (22%) patients with BRAF V600–mutant glioma, respectively. There were no on treatment deaths.

3.2.6.3.2 Efficacy results

In LGG patients with BRAF V600–mutant glioma treated with D+T, 25% (9/36) (95% CI: 12.1, 42.2) had ORR by independent review and 64% (23/36) had stable disease. The median DOR was 33.6 months (95% CI: 11.2, NE). The estimated 24-month DOR rate was 80% (95% CI: 30, 100). The median independently assessed PFS was 36.9 months (95% CI: 36.0, NE). The EAG notes that although this is an exploratory descriptive analysis of a single arm study in LGG relapse/refractory population, it does agree with the company that the study does show some promising results which should be explored further to address the unmet need in treating patients with relapsed/refractory paediatric LGG.

3.3 Meta-analysis

The company reports that it was not possible to perform a pairwise meta-analysis given the available data. For the LGG cohort, evidence from the TADPOLE trial was used in the economic model to inform the D+T and C+V arm. For the HGG cohort, an ITC was performed. Critique of the trials included, and the methods used in the ITC is presented in Section 3.4 and 3.5.

3.4 Critique of trials identified and included in the indirect comparison: HGG

The company conducted a SLR to collate the published studies which assess the efficacy and safety of therapies prescribed for the treatment of HGG in a paediatric population with BRAF V600E mutation-positive glioma. Due to the paucity of data in the BRAF V600E mutation-positive glioma population, the population criterion from the NICE Scope¹² was broadened to identify studies reporting clinical efficacy and safety, within paediatric patients with high-grade glioma, irrespective of mutation profile, or molecularly unselected patients.

The inclusion criteria for the ITC systematic review were as follows (see CS², Appendix D pages 15-16): the population of interest was children and adolescent (≥ 12 months and < 18 years of age) with HGG who were relapsed, refractory, resistant, progressed, or failed to respond to previous systemic therapy; the interventions of interest were dabrafenib in combination with trametinib, other available mono or combination therapy for HGG in paediatric population (Vincristine, carboplatin, temozolomide, lomustine, vorinostat, bevacizumab, irinotecan, vinblastine cisplatin, cyclophosphamide, thioguanine, procarbazine, vandetanib, dasatinib topotecan, thalidomide, etoposide, celecoxib, tamoxifen, etanidazole, carmustine, paclitaxel, trabectedin, everolimus, vemurafenib, erlotinib, nimotuzumab, imatinib, cilengitide, temsirolimus, tipifarnib, lobradimil, 'poly iclc', vorasidenib, day101, lenvatinib, fulvestrant, celecoxib, antineoplastons A10, antineoplastons AS2-1, nivolumab, ipilimumab, pomalidomide, cabazitaxel, cetuximab, imetelstat, crenolanib, lobradimil, carboplatin, sunitinib, chemotherapy); the relevant study design related to RCT, nRCT, single arm studies, observational studies including database studies, registry studies and the outcomes included efficacy (ORR, DOR, PFS, TTR, CBR, OS) and safety/tolerability (any AEs, any SAEs, any treatment-related AEs, tolerability data).

The systematic review methods undertaken for the ITC (e.g., literature searching, study selection, data extraction and quality assessment) were the same as those undertaken for the D+T systematic review (see Section 3.1.1) and therefore have the same limitations. In addition, as noted in Section 3.1.1 adequate systematic searches were also undertaken to identify all relevant studies assessing the efficacy and safety of therapies prescribed for the treatment of HGG in a paediatric population.

3.4.1 No prior TMZ subgroup

The company's systematic review did not identify any relevant comparator studies for TMZ in the BRAF V600E mutation-positive paediatric patient population for HGG. Using the broader SLR criteria, seven TMZ studies were identified. Of which, two were relevant for the indirect comparisons: Lashford *et al.*,⁴⁴ and Verschuur *et al.*,⁴⁵ both conducted in patients who were not previously treated with TMZ. As noted in CS² Appendix D, Table 12, the five remaining TMZ studies were not deemed suitable for inclusion in the ITC due to lack of baseline characteristic data and/or limited outcome data. The EAG queried whether study authors were contacted to obtain these additional data. It was confirmed in the company's clarification response (question A4)¹⁶ that "*authors were not contacted to obtain information on glioma subtype and baseline characteristics. While a potential limitation, none of these studies would have met the primary objective of the review (e.g. BRAF V600 patients).*" In addition, it was unclear to the EAG why the company only included studies of TMZ in the ITC. As noted in the company's response to clarification (question A6 and A14)¹⁶ "*Temozolomide (TMZ) was identified by the clinical experts to be the key chemotherapy comparator for dabrafenib with trametinib (D+T) in patients with high-grade glioma (HGG) who were not previously treated with TMZ hence studies*

evaluating other chemotherapy regimens were not included.” A summary of the design and study characteristics of the three studies included in the ITCs; TADPOLE,¹¹ Lashford *et al.*,⁴⁴ and Verschuur *et al.*,⁴⁵ as reported in the CS², and Appendix D is provided in Table 15 and the baseline characteristics are reported in Table 16.

Table 15: Summary of study design and characteristic of included in the ITC analyses (reproduced from CS², Appendix D, Table 13, Table 14, Table 15, Table 18 amended and Table 19)

Study	Study Design	Patient characteristics	Treatment and Sample size	Number of prior treatment	Prior treatment	Endpoints and definition	Data Available
TADPOLE ¹¹	Phase 2, single-arm, open-label, multicentre study	<p>BRAF V600E mutation-positive HGG patients aged ≥ 12 months to < 18 years who relapsed, progressed, or failed to respond to frontline therapy.</p> <p>Excluded if malignancy other than <i>BRAF</i> V600E mutant HGG</p> <p>Karnofsky/ Lansky PS $\geq 50\%$</p> <p>Adequate bone marrow function, renal function, liver function, cardiac function</p> <p>HGG diagnosis: Locally determined and centrally confirmed measurable disease</p>	<p>Dabrafenib + trametinib (BRAF V600E inhibitor and MEK inhibitor)</p> <p>N=41</p>	≥ 1	<p>If receiving glucocorticoids, stable or weaning dose for ≥ 7 days prior to first dose of study treatment</p> <p>Excluded if had previous treatment with RAF inhibitor, MEK inhibitor, or ERK inhibitor</p>	<p>OS - Time from first dose of study treatment to death due to any cause</p> <p>PFS - Time from first dose of study treatment to progression or death due to any cause, as assessed separately by central independent reviewer per RANO criteria^{26, 27}</p> <p>ORR - Defined as the proportion of patients with BOR of confirmed CR or PR by independent review as per RANO criteria^{26, 27}</p>	IPD
Lashford 2002 ⁴⁴	Phase 2, multicentre, UKCCSG and SFOP intergroup study	<p>HGG patients aged ≥ 3 years to ≤ 18 year, who relapsed</p> <p>Adequate PS as determined by Karnofsky or Lansky play scale</p> <p>Adequate PS was defined as PS of 2</p> <p>Organ function NR</p>	<p>Temozolomide (Chemotherapy)</p> <p>N=55 (34 with HGG)</p>	≥ 1	<p>Recurred after conventional treatment</p> <p>Recovered from toxic effects of previous therapy</p> <p>Stable dose of steroids ≥ 7 days</p>	<p>ORR - Defined as CR or PR. Overall (best) response rates (i.e. maximal tumour response documented at any time during treatment)</p>	Aggregate

Study	Study Design	Patient characteristics	Treatment and Sample size	Number of prior treatment	Prior treatment	Endpoints and definition	Data Available
		HGG diagnosis: Measurable disease defined as an enhancing, bi-dimensional lesion documented on Gd-MRI Life expectancy >9 weeks					
Verschuur 2004 ⁴⁵	Single centre [†] Inclusion period: May 1998 to Feb 2001; patients were treated after the Lashford 2002 (UKCCSG/SFOP) Phase 2 TMZ trial was completed	HGG patients aged ≥ 1 years to ≤ 21 years who had recurrence or progression after neurosurgery \pm radiotherapy \pm chemotherapy Performance statuses NR Organ function NR HGG diagnosis: Measurable disease Excluded patients with brainstem glioma	Temozolomide (Chemotherapy) N=20 (15 treated after radiotherapy and 5 treated prior to radiotherapy)	NR	NR	OS - determined from the start of TMZ treatment for each patient PFS - Interval between first day of first cycle of TMZ and occurrence of tumour progression ORR - Defined as CR or PR. Response criteria were according to WHO (WHO, 1979), ⁴⁶ using the product of the two maximal diameters of the tumour. Best response was determined at any evaluation moment during the treatment period	IPD for PFS and ORR Aggregate data for OS

[†]Unclear where the single centre was, however the correspondence was for Department of Paediatric Oncology, Academic Medical Centre, University of Amsterdam, Emma Childrens' Hospital.

Abbreviations: BRAF, BRAF oncogene;; Gd-MRI, Gadolinium-based enhanced Magnetic Resonance Imaging; HGG, high-grade glioma; IPD, individual patient data; MEK, mitogen-activated protein kinase;; NR, not reported;; PFS, progression-free survival; PS, performance score; ORR, overall response rate; OS, overall survival; TMZ, temozolomide;; UKCCG/SFOP, United Kingdom Children's Cancer Study Group/Pharmacology Group of the French Pediatric Oncology Society.

Table 16: Baseline characteristics of studies included in ITCs (reproduced from CS², Appendix D, Table 16)

Study name	TADPOLE ¹¹ (IPD available)	Lashford 2002 ⁴⁴	Verschuur 2004 ⁴⁵ (IPD available)
Treatment	D+T	TMZ	TMZ
Population	HGG	HGG (eligible study arm A)	HGG
N	41	25	20
Age; median (Range)	13 (2, 17)	13 (4.2, 17.5)	10.0 (3, 20.5)
Sex; n (%)			
Male	18 (43.9)	12 (48.0)	NR
Female	23 (56.1)	13 (52.0)	NR
Race/Ethnicity; n (%)			
White	25 (61.0)	NR	NR
Asian	11 (26.8)	NR	NR
Black or African American	1 (2.4)	NR	NR
Other	4 (9.8)	NR	NR
WHO tumour grade (central histology); n (%)			
Grade II	████████	–	1 (5.0)
Grade III	████████	14 (56.0)	11 (55.0)
Grade IV	████████	10 (40.0)	8 (40.0)
Other	████████████████	1 (4.0)	0 (0)
KPS or Lansky index score; n (%)			
<70	5 (12.2)	NR	NR
70-80	8 (19.5)	NR	NR
90-100	28 (68.3)	NR	NR
PS; n (%)			
0	NR	8 (32.0)	NR
1	NR	8 (32.0)	NR
2	NR	5 (20.0)	NR
3	NR	3 (12.0)	NR
Prior surgery; n (%)	40 (97.6)	NR	16 (80.0)
Prior radiation therapy; n (%)	37 (90.2)	25 (100.0)	14 (70.0)
Prior chemotherapy; n (%)	33 (80.5)	11 (44.0)	10 (50.0)
Metastasis; n (%)	NR	NR	7 (35.0)
Prior corticosteroids; n (%)	NR	NR	9 (45.0)

Abbreviations: D, dabrafenib; HGG, high-grade glioma; IPD, individual patient data; KPS, Karnofsky performance score; NR, not reported; PS, performance score; T, trametinib; TMZ, temozolomide; WHO, World Health Organization.

The main differences noted between the studies relate to patient characteristics, study design and availability of outcomes including definitions.

TADPOLE¹¹ enrolled patients with BRAF V600E mutation; neither Lashford *et al.*,⁴⁴ nor Verschuur *et al.*,⁴⁵ measured BRAF V600E status. The EAG accepts the company's decision on this due to paucity of data available for patients with BRAF V600E mutation but is unclear the impact this will have on the outcome results and whether the studies are comparable.

The upper and lower age limit of children and adolescents varied between the included studies. Age inclusion/exclusion were considered by the company during population trimming, before the population adjustment, to ensure trials included the same age of patients where possible. However, this would result in the lower age limit to be 3 years, hence deviating from the licence indication and the NICE scope.¹² The EAG is unsure how this would impact on the evaluation of effectiveness and safety of the therapy and it is unclear if the results of the outcome of interest would be generalisable to younger patients who are aged one and two years old.

Verschuur *et al.*,⁴⁵ excluded patients with brainstem glioma. In addition, Lashford *et al.*⁴⁴ did not enrol patients with brainstem glioma. To keep the patient population consistent in the ITC analysis, the company excluded patients with brainstem glioma (may also called diffuse midline glioma (DMG)) from the TADPOLE study.¹¹

Organ function and performance status at baseline was either not reported or not consistently reported between studies. TADPOLE¹¹ used KPS/LPS scale whilst Lashford *et al.*,⁴⁴ used performance score (PS). As reported in the CS², conversion was made for population matching by the company using the broad conversion of patients with PS of 0 being equivalent to those with KPS/LPS score of 90–100. This showed patients in Lashford *et al.*,⁴⁴ had generally poorer PS scores compared with patients in TADPOLE¹¹; for example, 32% vs 68.3% of patients, respectively, had a PS of 0, hence it is difficult for the EAG to assess the similarities between the population.

Number and type of prior therapies used in patients between the included studies varied. TADPOLE and Lashford *et al.*⁴⁴ enrolled patients with ≥ 1 prior treatments, whereas Verschuur *et al.*⁴⁵ did not restrict enrolment by number of prior treatments. Lashford *et al.*,⁴⁴ did not report the prior surgery status of enrolled patients, whilst in TADPOLE¹¹ 97.6% of patients had prior surgery and 80.0% in Verschuur *et al.*⁴⁵ In Lashford *et al.*,⁴⁴ all patients had prior radiotherapy, whilst in TADPOLE¹¹ and Verschuur *et al.*,⁴⁵ 90.2% and 70% had prior radiotherapy, respectively. Prior chemotherapy exposure was in 80.5% in TADPOLE,¹¹ 50.0% in Verschuur *et al.*,⁴⁵ and 44.0% in Lashford *et al.*⁴⁴ Time since chemotherapy

was similar between the studies although time since radiotherapy was wide-ranging. Further details are provided in CS², Appendix D, Table 15.

The original CS² did not provide any information/data on study quality assessment for all the studies included in the ITC. However, these was provided using the Downs and Black checklist²¹ following a request from the EAG as presented in the company's clarification response (question A8)¹⁶ reporting a cumulative score of 13 in Verschuur *et al.*,⁴⁵ 17 in Lashford *et al.*,⁴⁴ and 25 in TADPOLE¹¹ and stated that *"the differences between the scores were driven by incomplete reporting of methodology and outcomes in older the single-arm trials for temozolomide."*¹⁶

A summary of the methodological quality assessment undertaken by the company and by the EAG is presented in Table 17. The EAG notes that checklist item 11 (Is the source of funding clearly stated?), is not part of the Downs and Black checklist²¹ and therefore would increase the overall score. There was a slight variation in scoring between the company and the EAG, mainly around the single arm design of the TADPOLE HGG cohort study,¹¹ nonetheless this did not impact the assessment for the overall quality of the study. While the company did not provide interpretation of the scoring and quality of the study, the EAG notes that in accordance with previous publications,^{21, 23, 36, 37} the TADPOLE study¹¹ would be considered as a good quality study (scoring between 20–25) whereas the Lashford *et al.*,⁴⁴ study would be considered as fair quality study (scoring between 15–19) and the Verschuur *et al.*,⁴⁵ study would be considered as a poor quality study (scoring ≤ 14), Table 17.

Table 17: Quality assessment of ITC studies (reproduced from Clarification response A8¹⁶)

Checklist item	Lashford 2002 ⁴⁴				Verschuur 2004 ⁴⁵				TADPOLE ¹¹				
	Company's assessment		EAG's assessment		Company's assessment		EAG's assessment		Company's assessment		EAG's assessment		
	Assessment	Score	Assessment	Score	Assessment	Score	Assessment	Score	Assessment	Score	Assessment	Score	
Reporting Yes = 1 / No = 0 / Unable to determine = 0													
1	Is the objective of the study clear?	Yes	1	Yes	1	Yes	1	Yes	1	Yes	1	Yes	1
2	Are the main outcomes clearly described in the Introduction or Methods?	Yes	1	Yes	1	No	0	Yes	1	Yes	1	Yes	1
3	Are characteristics of the patients included in the study clearly described?	Yes	1	Yes	1	Yes	1	Yes	1	Yes	1	Yes	1
4	Are the interventions clearly described?	Yes	1	Yes	1	Yes	1	Yes	1	Yes	1	Yes	1
5	Are the distributions of principal confounders in each group of subjects clearly described?	Yes	1	Unable to determine	0	Yes	1	Unable to determine	0	Yes	2	Yes	2
6	Are the main findings of the study clearly described?	Yes	1	Yes	1	Yes	1	Yes	1	Yes	1	Yes	1
7	Does the study estimate random variability in data for main outcomes?	Yes	1	Yes	1	No	0	Yes	1	Yes	1	Yes	1
8	Have all the important adverse events consequential to the intervention been reported?	Yes	1	Yes	1	Unable to determine	0	Unable to determine	0	Yes	1	Yes	1
9	Have characteristics of patients lost to follow-up been described?	Yes	1	Yes	1	Yes	1	Yes	1	Yes	1	Yes	1
10	Have actual probability values been reported for	Unable to determine	0	Unable to determine	0	Unable to determine	0	Unable to determine	0	Yes	1	Yes	1

		Lashford 2002 ⁴⁴				Verschuur 2004 ⁴⁵				TADPOLE ¹¹			
	Checklist item	Company's assessment		EAG's assessment		Company's assessment		EAG's assessment		Company's assessment		EAG's assessment	
		Assessment	Score	Assessment	Score	Assessment	Score	Assessment	Score	Assessment	Score	Assessment	Score
	the main outcomes except probability <0.001?												
11	Is the source of funding clearly stated?	Yes	1	Yes	1	No	0	No	0	Yes	1	Yes	1
External validity													
12	Were subjects who were asked to participate in the study representative of the entire population recruited?	Yes	1	Yes	1	Yes	1	Unable to determine	0	Yes	1	Yes	1
13	Were those subjects who were prepared to participate representative of the recruited population?	Yes	1	Yes	1	Yes	1	Unable to determine	0	Yes	1	Yes	1
14	Were staff, places, and facilities where patients were treated representative of treatment most received?	Yes	1	Yes	1	Yes	1	Yes	1	Yes	1	Yes	1
Internal validity													
15	Was an attempt made to blind study subjects to the intervention?	No	0	No	0	No	0	No	0	No	0	No	0
16	Was an attempt made to blind those measuring the main outcomes?	No	0	No	0	No	0	Unable to determine	0	No	0	No	0
17	If any of the results of the study were based on data dredging was this made clear?	Not applicable	0	Unable to determine	0	Not applicable	0	Unable to determine	0	Yes	1	Yes	1

		Lashford 2002 ⁴⁴				Verschuur 2004 ⁴⁵				TADPOLE ¹¹			
	Checklist item	Company's assessment		EAG's assessment		Company's assessment		EAG's assessment		Company's assessment		EAG's assessment	
		Assessment	Score	Assessment	Score	Assessment	Score	Assessment	Score	Assessment	Score	Assessment	Score
18	Was the time period between intervention and outcome the same for intervention and control groups or adjusted for?	Not applicable	0	Yes	1	Not applicable	0	Not applicable	0	Yes	1	Not applicable	0
19	Were the statistical tests used to assess main outcomes appropriate?	Yes	1	Yes	1	Yes	1	Yes	1	Yes	1	Yes	1
20	Was compliance with the interventions reliable?	Yes	1	Yes	1	Yes	1	Yes	1	Yes	1	Yes	1
21	Were main outcome measures used accurate? (valid and reliable)	Yes	1	Yes	1	Yes	1	Yes	1	Yes	1	Yes	1
Internal validity-confounding (selection bias)													
22	Were patients in different intervention groups recruited from the same population?	Not applicable	0	No	0	Not applicable	0	Not applicable	0	Yes	1	Not applicable	0
23	Were study subjects in different intervention groups recruited over the same period of time?	Not applicable	0	Unable to determine	0	Not applicable	0	Not applicable	0	Yes	1	Not applicable	0
24	Were study subjects randomized to intervention groups?	No	0	No	0	No	0	No	0	No	0	No	0
25	Was the randomized intervention assignment concealed from patients and staff until recruitment was complete?	Not applicable	0	Not applicable	0	Not applicable	0	Not applicable	0	No	0	Not applicable	0
26	Was there adequate adjustment for confounding in the	No	0	No	0	No	0	No	0	Yes	1	Yes	1

		Lashford 2002 ⁴⁴				Verschuur 2004 ⁴⁵				TADPOLE ¹¹			
Checklist item	Company's assessment		EAG's assessment		Company's assessment		EAG's assessment		Company's assessment		EAG's assessment		
	Assessment	Score	Assessment	Score	Assessment	Score	Assessment	Score	Assessment	Score	Assessment	Score	
	analyses from which main findings were drawn?												
27	Were losses of patients to follow-up taken into account?	Yes	1	Yes	1	Yes	1	Yes	1	Yes	1	Yes	1
Power													
28	Was the study sufficiently powered to detect clinically important effects where probability value for a difference due to chance is <5%?	Unable to determine	0	Unable to determine	0	Unable to determine	0	Unable to determine	0	Yes	1	Yes	1
	Total score		17		17		13		12		25		22

3.4.2 Prior TMZ subgroup

The EAG noted that the CS² did not present or discuss the ITC of D+T vs BSC, whereby BSC is defined as pain and symptom management and psychosocial support in patients who have been previously treated with TMZ. In response to (clarification question A15),¹⁶ the company clarified that no studies were identified in the SLR of D+T vs BSC and “it was highlighted by clinical experts that following TMZ failure, chemotherapy tends to be ineffective, and therefore using chemotherapy studies in patients previously treated with TMZ is a reasonable proxy in the economic model to inform the prognosis of patients on BSC (although likely to be optimistic) in the absence of alternative evidence. Clinical experts further explained that the aim of BSC treatment focusses on treating the symptoms and no longer the tumour, and therefore progression-free survival (PFS) is not considered a relevant outcome for the comparison against BSC.”

As requested by the EAG, an ITC was provided that compares D+T vs the two proxy studies for BSC identified in the SLR in patients previously treated with TMZ (MacDonald *et al.*, [cilengitide]⁴⁸ and Narayana *et al.*, [bevacizumab]).⁴⁹ A summary of the design and study characteristics of the three studies; MacDonald *et al.*,⁴⁸ Narayana *et al.*,⁴⁹ and TADPOLE¹⁴ are reported in Table 18 as presented in the CS (clarification response A15, Table 3, Table 4, Table 5, Table 8 and Table 9)¹⁶ and the baseline characteristics are reported in Table 19, as presented in the CS (clarification response A15, Table 6).¹⁶

There were many differences noted between the studies, including study design, patient characteristics, sample size and prior therapy. TADPOLE¹⁴ enrolled patients with BRAF V600E mutation; neither Narayana *et al.*,⁴⁹ nor MacDonald *et al.*,⁴⁸ measured BRAF V600E status. Patients recruited in both TADPOLE¹⁴ and MacDonald *et al.*,⁴⁸ were progressive and relapsed/refractory to standard therapy, whilst Narayana *et al.*,⁴⁹ only reported the inclusion of recurrent patients. The upper and lower age limit of children and adolescents varied between the included studies, TADPOLE¹⁴ specified an upper age limit of 18 years compared with 22 years in MacDonald *et al.*,⁴⁸ whereas Narayana *et al.*,⁴⁹ did not report age as an inclusion criteria. However, it was not clear if these differences were considered by the company during population trimming. In addition, tumour grade varied across the studies. TADPOLE¹⁴ enrolled approximately ██████ Grade III patients and ██████ Grade IV patients whereas MacDonald *et al.*,⁴⁸ enrolled 12.5% of Grade III patients and approximately three times the proportion of Grade IV patients (62.5%). Narayana *et al.*,⁴⁹ enrolled more Grade III patients at 75% and ██████,¹⁴ 25% Grade IV patients. MacDonald *et al.*,⁴⁸ excluded patients with pontine gliomas, gliomatosis cerebri, primary spinal cord high-grade glioma, or evidence of prior central nervous system (CNS) bleed. To keep the patient population consistent in the MAIC analysis, the company excluded these patients from the TADPOLE study¹⁴ before making population adjustment. The number of prior therapies differed between the studies at baseline; in the TADPOLE study¹⁴ patients received ≥ 1 prior treatment, in MacDonald *et al.*,⁴⁸ patients did not receive >2 prior treatments (1 initial and 1 for relapse) and in

Narayana *et al.*,⁴⁹ the number of prior treatments was not reported. Therefore, patients with >2 prior treatments were excluded by the company's analysis from TADPOLE study¹⁴ during population trimming for comparisons with MacDonald *et al.*⁴⁸ In addition, both TADPOLE study¹⁴ and MacDonald *et al.*,⁴⁸ were Phase II studies and Narayana *et al.*,⁴⁹ was a retrospective study.

Table 18: Summary of study design and characteristic of included in the MAIC analyses (reproduced from Clarification response A15¹⁶, Table 3, Table 4, Table 5, Table 8 and Table 9 amended)

	TADPOLE ¹⁴	MacDonald <i>et al</i> (2013) ⁴⁸	Narayana <i>et al</i> (2010) ⁴⁹
Study Design	Phase 2, single-arm, open-label, multicentre study	Phase 2, COG ACNS0621	Retrospective analysis of 12 consecutive paediatric patients who were diagnosed with recurrent HGG between September, 2005 and July, 2008 at New York University Langone Medical Center
Patient characteristics	BRAF V600 mutation-positive HGG Patients aged ≥ 12 months to < 18 years who relapsed, progressed, or failed to respond to frontline therapy. Excluded if malignancy other than BRAF V600 mutant HGG Karnofsky/ Lansky PS $\geq 50\%$ Adequate bone marrow function, renal function, liver function, cardiac function	HGG patients aged < 22 years who are progressive and refractory to standard therapy. Included GBM, AA, anaplastic oligodendroglioma, high-grade astrocytoma NOS or gliosarcoma. Excluded patients with pontine gliomas, gliomatosis cerebri, primary spinal cord high-grade glioma, or evidence of prior CNS bleed Adequate PS was defined as PS of 0-2 Adequate organ function	HGG recurrent patient Included Supratentorial HGG, DIPG Age: NR Performance statuses: NR Organ function: NR Excluded patients: NR
HGG diagnosis	Locally confirmed histologic diagnosis of BRAF V600 mutation-positive HGG (Grade III or IV)	Pathologist diagnostic	NR
Treatment and Sample size	Dabrafenib + trametinib (BRAF V600 inhibitor and MEK inhibitor) N=41	Cilengitide (Prototypic integrin inhibitor) N=30 (24 evaluable patients)	Bevacizumab (Monoclonal antibody, targeted therapy called an angiogenesis inhibitor) N=12 (10 with supratentorial HGG and 2 with DIPG)

	TADPOLE ¹⁴	MacDonald <i>et al</i> (2013) ⁴⁸	Narayana <i>et al</i> (2010) ⁴⁹
Number of prior treatment	≥1	≤2†	NR
Prior treatment	If receiving glucocorticoids, stable or weaning dose for ≥7 days prior to first dose of study treatment Excluded if had previous treatment with RAF inhibitor, MEK inhibitor, or ERK inhibitor	Recovered from all prior therapy Prior local irradiation and alkylator-based chemotherapy or chemotherapy alone if <3 years of age Patients <3 years of age initially treated with chemotherapy alone could have been treated with radiation at time of first relapse	All patients underwent maximal surgical resection of the tumour when feasible at the time of initial diagnosis followed by radiation therapy and chemotherapy. TMZ was the initial chemotherapy of choice and was received by 11 patients both during and following radiotherapy
Endpoints and definition	OS - Time from first dose of study treatment to death due to any cause PFS – Time from first dose of study treatment to progression or death due to any cause, as assessed separately by central independent reviewer per RANO criteria ORR - Defined as the proportion of patients with BOR of confirmed CR or PR by independent review as per RANO criteria	OS- event included death owing to any cause EFS- event included tumour progression or recurrence, second malignant neoplasm, or death ORR- Defined as the proportion of patients with BOR of confirmed CR or PR by independent review as per RANO criteria Confirmed CR, PR or SD that was sustained for at least 12 weeks	OS - from the time of bevacizumab therapy to the time of death PFS - Progression was defined as a 25% or greater increase in the size of a pre-existing enhancing lesion, appearance of a new lesion, or neurological deterioration that cannot be attributed to another cause. PFS was measured from the time of the initial bevacizumab treatment to the date of first radiological/clinical progression ORR - CR + improvement (partial radiological response) Radiological response: MacDonald criteria, which use maximal cross-sectional T1 contrast images on MRI as well as Fluid Attenuated Inversion Recovery sequences, were used to define the radiological response
Data Available	IPD	Aggregate	Aggregate

†Patients could not have received > 2 prior treatments (1 initial and 1 for relapse)

Abbreviations: BSC, best supportive care; BOR, best overall response; CNS, central nervous system; CR, complete response; D, dabrafenib; EFS, event free survival; ERK, extracellular signal-regulated kinase; IPD, individual patient data; ITC, indirect treatment comparison; MEK, mitogen-activated protein kinase kinase; NR, not reported; ORR, overall response rate; OS, overall survival; PFS, progression-free survival; RAF, rapidly accelerated fibrosarcoma; RANO, response assessment in neuro-oncology; T, trametinib; TMZ, temozolomide.

Table 19: Baseline characteristics of studies included in the BSC ITC analyses (Clarification response A15¹⁶, Table 6)

Study name	TADPOLE ¹⁴ (IPD available)	MacDonald <i>et al</i> (2013) ⁴⁸	Narayana <i>et al</i> (2010) ⁴⁹
Treatment	D+T	Cilengitide	Bevacizumab
Population	HGG	Evaluable patients	HGG + DIPG
N	41	24	12
Age; median (Range)	13 (2, 17)	14.2 (1.13, 20.3)	14.75 (4, 22)
Sex; n (%)			
Male	18 (43.9)	12 (50.0)	7 (58.3)
Female	23 (56.1)	12 (50.0)	5 (41.7)
Race/Ethnicity; n (%)			
White	25 (61.0)	NR	NR
Asian	11 (26.8)	NR	NR
Black or African American	1 (2.4)	NR	NR
Other	4 (9.8)	NR	NR
WHO tumour grade (central histology); n (%)			
Grade II	██████	–	–
Grade III	██████	3 (12.5) [†]	9 (75.0)
Grade IV	██████	18 (62.5) [†]	3 (25.0)
Other	Missing: ██████	NOS: 3 (12.5) [†]	–
KPS or Lansky index score; n (%)			
<70	5 (12.2)	NR	–
70-80	8 (19.5)	NR	6 (50.0)
90–100	28 (68.3)	NR	6 (50.0)
PS; n (%)			
0	28 (68.3) [‡]	NR	6 (50.0) [‡]
1	8 (19.5) [‡]	NR	6 (50.0) [‡]
2	5 (12.2) [‡]	NR	–
3	–	NR	–
Prior surgery; n (%)	40 (97.6)	NR	12 (100.0) [¶]
Prior radiation therapy; n (%)	37 (90.2)	22 (91.7)	12 (100.0)
Prior chemotherapy; n (%)	33 (80.5)	20 (83.3) [‡]	12 (100.0) [§]
Metastasis; n (%)	NR	NR	NR
Prior corticosteroids; n (%)	NR	NR	NR

[†]Histology by review. [‡]All 20 patients received prior TMZ. [¶]Gross total resection. [§]11 patients received prior TMZ.

[‡]Converted from KPS or Lansky index score.

Abbreviations: BSC, best supportive care; D, dabrafenib; DIPG, diffuse intrinsic pontine glioma; HGG, high-grade glioma; IPD, individual patient data; ITC, indirect treatment comparison; KPS, Karnofsky performance score; NOS, not otherwise specified; NR, not reported; PS, performance score; T, trametinib; TMZ, temozolomide; WHO, World Health Organization.

3.5 Description and critique of the indirect comparison: HGG

In the absence of head-to-head trials comparing the relative efficacy of D+T with comparator treatments of HGG in paediatric patients with BRAF V600E mutations, the company conducted an ITC. As TADPOLE HGG prospective cohort study¹¹ was a single-arm trial design, unanchored matching-adjusted indirect comparisons (MAIC) and inverse of probability of treatment weighting (IPTW) methodologies were utilised to derive the relative efficacy of D+T vs comparator treatments. MAIC was used when the comparator study only provides aggregate data and IPTW was used when individual patient-level data are available from the comparator study.

3.5.1 No prior TMZ subgroup

The company performed ITC analyses for all patients in the studies regardless of TMZ status at enrolment and for the no prior TMZ subgroup. The no prior TMZ subgroup was of primary interest. The company conducted MAIC analysis for OS based on TADPOLE and Verschuur *et al.*, and for ORR based on TADPOLE and Lashford *et al.* The company also conducted IPTW analysis for PFS and ORR based on TADPOLE and Verschuur *et al.* Both MAIC and IPTW analysis when comparing to Verschuur *et al.* adjusted for age, prior radiotherapy and prior chemotherapy. Sensitivity analysis was also performed adjusting for tumour grade as well for all patients. Additional trimming was performed to the available IPD to balance the population characteristics between the studies compared. MAIC analysis when comparing to Lashford *et al.* adjusted for age and prior chemotherapy.

The OS and PFS ITC results comparing D+T (from TADPOLE) and TMZ (from Verschuur *et al.*) for no prior TMZ subgroup are presented in Table 20. The ORR ITC results (vs Verschuur *et al.* and vs Lashford *et al.*) can be found in CS Appendix D. The ITC results show that D+T is associated with significantly better OS, PFS and ORR compared with TMZ in the no prior TMZ subgroup. The EAG notes that the sample size and effective sample size are small, and the adjusted results are very similar to the results from the naïve comparisons.

Table 20: Summary of OS and PFS ITC (no prior TMZ subgroup): D+T (TADPOLE) vs TMZ (Verschuur *et al.*) (adapted from CS Table 25 and Table 27)

Treatment (vs Verschuur <i>et al.</i>)	N/ESS	Events	Median, months (95% CI)	D+T vs TMZ HR (95% CI)
Overall survival (MAIC)				
D+T naïve comparison	■	■	■	■
D+T weighted	■	■	■	Standard: ■ Bootstrap: ■
TMZ	20	16	8.53 (2.98, 18.95)	Comparator
Progression-free survival independent review (IPTW)				
D+T naïve comparison	■	■	■	■
TMZ unweighted	11	11	2.0 (1.5, NE)	Comparator
D+T weighted	■	■	■	Robust SE: ■
TMZ weighted	■	■	■	Comparator

Abbreviations: CI, confidence interval; D, dabrafenib; HR, hazard ratio; MAIC, matching-adjusted indirect comparison; IPTW, inverse probability of treatment weighting; NE, not evaluable; PFS, progression-free survival; SE, standard error; T, trametinib; TMZ, temozolomide.

The EAG agrees with the methods used for the ITCs for the no prior TMZ subgroup. The EAG also agrees with the company that the ITC analyses are associated with uncertainty, and highlights that only limited number of covariates were adjusted; sample sizes are small for the included studies; BRAF V600E mutation status are unknown for both studies informing the TMZ arm; and both studies were conducted about 20 years ago leading to a question on the generalisability of the current clinical practice.

3.5.2 Prior TMZ subgroup

The company did not present the ITC results of D+T vs BSC for the prior TMZ subgroup in the CS. In response to clarification question A15,¹⁶ the company presented unanchored MAIC analysis vs BSC for OS, PFS and ORR using MacDonald *et al.* and Narayana *et al.* as potential proxies for BSC. The MAIC analysis adjusted for age, prior radiotherapy and prior TMZ when comparing to MacDonald *et al.* and adjusted for age and prior TMZ when comparing to Narayana *et al.* The ITC results for OS and PFS are presented in Table 21 and Table 22. The results for ORR can be found in response to clarification question A15. The EAG notes that the population used in the analysis is a mixture of no prior TMZ and prior TMZ patients.

The ITC results show that D+T is associated with significantly better OS, PFS and ORR compared with BSC. The EAG notes that the sample size and effective sample size are small, and the adjusted results are very similar to the results from the naïve comparisons.

Table 21: Summary of OS and PFS MAIC: D+T (prior TMZ subgroup) (TADPOLE) vs cilengitide (MacDonald *et al.*) (adapted from clarification response¹⁶ Table 12 and Table 13)

Treatment (vs MacDonald <i>et al.</i>)	N/ESS	Events	Median, months (95% CI)	D+T vs Cilengitide HR (95% CI)
Overall survival (MAIC)				
D+T naïve comparison	■	■	██████████	██████████
D+T weighted	■	■	██████████	██████████
Cilengitide	24	23	6.05 (3.99, NE)	Comparator
Progression-free survival independent review (MAIC)				
D+T naïve comparison	■	■	██████████	██████████
D+T weighted	■	■	██████████	██████████
Cilengitide	24	23	1.00 (0.94, 1.10)	Comparator

Abbreviations: CI, confidence interval; D, dabrafenib; HR, hazard ratio; MAIC, matching-adjusted indirect comparison; NE, not evaluable; PFS, progression-free survival; SE, standard error; T, trametinib; TMZ, temozolomide.

Table 22: Summary of OS MAIC: D+T (prior TMZ subgroup) (TADPOLE) vs bevacizumab (Narayana *et al.*) (adapted from clarification response¹⁶ Table 15)

Treatment (vs Narayana <i>et al.</i>)	N/ESS	Events	Median OS, months (95% CI)	D+T vs bevacizumab HR (95% CI)
Overall survival (MAIC)				
D+T naïve comparison	■	■	██████████	██████████
D+T weighted	■	■	██████████	██████████
Bevacizumab	12	10	6.67 (4.04, 11.0)	Comparator

Abbreviations: CI, confidence interval; D, dabrafenib; HR, hazard ratio; MAIC, matching-adjusted indirect comparison; NE, not evaluable; PFS, progression-free survival; SE, standard error; T, trametinib; TMZ, temozolomide.

The EAG agrees with the use of MAIC for the prior TMZ subgroup. The EAG highlights that the MAIC analyses are associated with uncertainty as the treatments included in the comparator studies are only proxies for BSC; only limited number of covariates were adjusted; sample sizes are small for the included studies; and BRAF V600E mutation status are unknown for both comparator studies.

3.6 Additional work on clinical effectiveness undertaken by the EAG

No additional work on clinical effectiveness was undertaken by the EAG.

3.7 Conclusions of the clinical effectiveness section

3.7.1 *Completeness of the CS with regard to relevant clinical studies and relevant data within those studies*

The clinical evidence in the CS² is based on a systematic review of the clinical effectiveness and safety of D+T for the treatment of paediatric patients with BRAF V600E mutation-positive LGG or relapsed or refractory HGG. The EAG is content that all relevant (published and unpublished) studies of D+T were included in the CS.²

3.7.2 *Interpretation of treatment effects reported in the CS in relation to relevant population, interventions, comparator and outcomes*

Key issues that may limit the robustness of the efficacy and safety data reported in the CS² was due to small population numbers and the target population. Paediatric glioma is a rare disease and there was a lack of evidence available for both LGG and HGG patients with BRAF V600E mutation in the paediatric population. The sample size within the trials were small and lacked in hierarchy study design especially in the BRAF V600E mutation-positive HGG population. Another issue that may limit the robustness of the efficacy evidence in the LGG RCT cohort was the HRQoL assessment and other subgroup analyses in participants from the TADPOLE trial¹¹ which used exploratory approaches and were not powered for the subgroup analyses.

The HGG component of the TADPOLE trial¹¹ was a single-arm study, therefore time-to-event endpoints such as PFS and OS are not interpretable in absence of an appropriate comparator arm and are considered descriptive only. Furthermore, the BRAF V600E mutation-positive HGG cohort was compared with historical data from molecularly unselected HGG cohorts. The ITC results are uncertain due to small sample size; differences between the compared studies; limited number of covariates were adjusted for in the analysis. Hence the ITC results should be interpreted with caution.

3.7.3 *Uncertainties surrounding the reliability of the clinical effectiveness*

The main uncertainties in the clinical evidence primarily relate to duration of treatment and follow-up to assess the safety profile of D+T. For the LGG cohort the median duration of exposure to dabrafenib was 140.0 weeks and exposure to trametinib was 135.1 weeks, and the median duration of follow-up was 39 months. In the HGG cohort the median duration of exposure to both dabrafenib and trametinib was 121.1 weeks at the time of the final analysis DCO and the median duration of follow-up was 45.2 months. As noted in the CS² the recommended duration of treatment with D+T is to continue until disease progression or until the development of unacceptable toxicity. As a result, the long-term efficacy

and safety of D+T is unknown and the optimum duration of therapy remains unclear, particularly because indefinite treatment may be required. The draft SmPC¹³ for D+T advises that there are limited data in patients older than 18 years of age with glioma, therefore continued treatment into adulthood should be based on benefits and risks to the individual patient as assessed by the physician.

4 COST EFFECTIVENESS

4.1 EAG's comment on company's review of cost-effectiveness evidence

The company conducted three reviews, which are detailed in the sections below.

4.1.1 *Objective of cost effectiveness review*

There were three objectives of the company's cost-effectiveness reviews. There were to identify:

- i) Published cost-effectiveness studies of children and adolescents with BRAF V600E mutations in LGG and HGG (CS², Appendix G)
- ii) HRQoL studies (CS², Appendix H)
- iii) Cost and resource use studies (CS², Appendix I)

Objective (i) is one review, despite covering two different populations. Whilst developing reviews for separate populations is generally recommended, given the rarity of glioma in children the EAG believes that conducting separate reviews is unlikely to have changed the results.

4.1.2 *Searches*

The company performed an initial SLR in July 2023 to identify literature for (i) published cost-effectiveness studies of children and adolescents with BRAF V600 mutations and LGG or relapsed or refractory HGG (CS², Appendix G), (ii) HRQoL studies (CS², Appendix H), (iii) cost and resource use studies (CS², Appendix I).

The company searched the following electronic bibliographic databases in July 2023 (CS², Appendix D.1.1 Identification and selection of relevant studies) for both cost-effectiveness and cost and resource use studies: MEDLINE including MEDLINE In-Process (via Ovid), EMBASE (via Ovid), CRD Database of Abstracts of Reviews of Effects (via Ovid), CRD Health Technology Assessment (via Ovid), CRD NHS Economic Evaluation Database (via Ovid), and EconLit (via Ovid). The EAG does not have access to the CRD databases via the Ovid host platform. The company also hand searched the bibliographies of relevant systematic reviews and meta-analysis to identify other new studies for inclusion.

For the economic evaluation SLR, HRQoL (health state utility values) and cost and resource search, supplementary searches were undertaken by the company in several key conference abstract websites in the last three years (2020-2023): American Society of Clinical Oncology annual meeting, British Neuro-Oncology Society annual meeting, European Association of Neuro-Oncology annual meeting, European Society for Medical Oncology, International Society of Pharmacoeconomics and Outcomes Research, and Society for Neuro-Oncology annual meeting.

The company has also searched ten health technology assessment agencies in July 2023: NICE, Scottish Medicines Consortium, All Wales Medicines Strategy Group, National Centre for Pharmacoeconomics, Pharmaceutical Benefits Advisory Committee, Canadian Agency for Drugs and Technologies in Health, Haute Autorité de Santé, German Institute for Quality and Efficiency in Health Care, Gemeinsamer Bundesausschuss (The Federal Joint Committee), and Institute for Clinical and Economic Review.

Grey literature searches were also carried out in July 2023 in the Cost Effectiveness Analysis Registry, EconPapers within Research Papers in Economics, EQ-5D via euroqol.org, The University of Sheffield Centre of Health and Related Research Health Utilities Database, and the HTA Database of the International Network of Agencies for Health Technology Assessment.

Comprehensive terms for glioma were combined with a cost-effectiveness search filter and paediatric terms. Whilst the terms applied and numbers retrieved in the search were fully reported, the search was limited to English-language publications. According to the Cochrane Handbook of systematic reviews and Campbell Collaboration, applying this limit can introduce language bias.¹⁷ The CS electronic searches of the economic SLR and cost and resource use search strategies are comprehensive, transparent (reference to study design filters applied) and fully reported.

In the HRQoL studies search (CS², Appendix H), the company searched similar sources to the cost-effectiveness SLR search (except EconLit) in July 2023. They have combined terms for the population and quality of life terms. The company did not use a published HRQoL filter and therefore the impact on the sensitivity of the search is unclear. Nevertheless, the EAG considered that the company search is comprehensive for the SLR.⁵⁰

4.1.3 The inclusion and exclusion criteria used in the study selection

The inclusion and exclusion criteria for the three reviews are presented in Table 23, Table 24 and Table 25.

Table 23: The inclusion and exclusion criteria for the cost-effectiveness review (replicated from CS², Appendix G, Table 6)

Characteristic	Inclusion criteria	Exclusion criteria
Population	<ul style="list-style-type: none"> • Children and adolescents (aged <18 years) with LGG or relapsed or refractory HGG, not limited to BRAF^{V600} mutation • Mixed populations: if ≥80% of patients meet the eligibility criteria or outcomes are reported separately for these patients 	<ul style="list-style-type: none"> • Adult patients (aged ≥18 years) • Mixed populations: if <80% of patients meet the eligibility criteria, unless outcomes are reported separately for these patients
Interventions/ comparators	<ul style="list-style-type: none"> • Any systemic therapy • Radiotherapy 	<ul style="list-style-type: none"> • Surgery • Interventions not listed
Outcomes	<ul style="list-style-type: none"> • Costs • Costs per outcome • Quality adjusted life years • Life years gained • Incremental cost-effectiveness ratio 	<ul style="list-style-type: none"> • Outcomes not listed
Study design	<ul style="list-style-type: none"> • Cost-effectiveness analysis • Cost-utility analysis • Cost-minimisation analysis [Cost-comparison analysis] • Cost-consequence analysis • Cost-benefit analysis • Cost offset analysis • Budget impact analysis 	<ul style="list-style-type: none"> • Reviews/editorials/commentaries/letters • SLRs/NMAs[†] • In vitro/animal studies • Cost analyses/cost of illness studies • SLRs/NMAs
Date limits	No restriction	-
Countries	No restriction	-
Languages	English language publications	Non-English language publications

[†] Relevant SLRs/NMAs were included at title/abstract screening stage so their bibliographic reference list could be hand-searched for relevant studies.

Abbreviations: HGG, high-grade lymphoma; LGG, low-grade glioma; NMA, network meta-analysis; PICOS, population, intervention, comparator, outcomes, and study design; SLR, systematic literature review.

Table 24: The inclusion and exclusion criteria for the health related quality of life review (replicated from CS², Appendix H, Table 5)

Characteristics	Inclusion criteria	Exclusion criteria
Population	<ul style="list-style-type: none"> • Patients of any age with LGG or HGG, not limited to <i>BRAF</i> V600 mutation • Mixed populations: if $\geq 80\%$ of patients meet the eligibility criteria or outcomes are reported separately for these patients 	<ul style="list-style-type: none"> • Mixed populations: if $< 80\%$ of patients meet the eligibility criteria, unless outcomes are reported separately for these patients
Intervention/comparators	No restriction	–
Outcomes	<ul style="list-style-type: none"> • Utilities/disutilities measured using EQ-5D[†] • Mapping algorithms (mapping to EQ-5D only) 	<ul style="list-style-type: none"> • Utilities/disutilities measured using a QoL instrument other than EQ-5D
Study design	<ul style="list-style-type: none"> • Studies reporting original HSUV data 	<ul style="list-style-type: none"> • Reviews/editorials/commentaries/letters • SLRs/NMAs[‡] • In vitro/animal studies
Date limits	No restriction	–
Countries	No restriction	–
Languages	English language publications	Non-English language publications

[†]Pragmatic approach taken to collect data of most relevance for HTA submissions;

[‡] Relevant SLRs/NMAs were included at title/abstract screening stage so their bibliographic reference lists could be hand-searched for relevant studies.

Abbreviations: HGG, high-grade lymphoma; HSUV, health-state utility value; LGG, low-grade glioma; NMA, network meta-analysis; PICOS, population, intervention, comparator, outcomes, and study design; QoL, quality of life; SLR, systematic literature review.

Table 25: The inclusion and exclusion criteria for the cost and health care resource use review (replicated from CS², Appendix I, Table 6)

Characteristic	Inclusion criteria	Exclusion criteria
Population	<ul style="list-style-type: none"> • Children and adolescents (aged <18 years) with LGG or relapsed or refractory HGG, not limited to <i>BRAF</i> V600 mutation • Mixed populations: if ≥80% of patients meet the eligibility criteria or outcomes are reported separately for these patients 	<ul style="list-style-type: none"> • Adult patients (aged ≥18 years) • Mixed populations: if <80% of patients meet the eligibility criteria, unless outcomes are reported separately for these patients
Interventions/ comparators	No restriction	–
Outcomes	<ul style="list-style-type: none"> • Measures of costs • Measures of healthcare resource use 	<ul style="list-style-type: none"> • Outcomes not listed
Study design	<ul style="list-style-type: none"> • Any studies reporting original cost and/or resource use data 	<ul style="list-style-type: none"> • Reviews/editorials/ commentaries/letter • SLRs/NMAs[†] • In vitro/animal studies
Date limits	2014 – present	Pre-2014
Countries	No restriction	–
Languages	English language publications	Non-English language publications

[†]Relevant SLRs/NMAs were included at title/abstract screening stage so their bibliographic reference lists could be hand-searched for relevant studies.

Abbreviations: HCRU, Healthcare resource use; HGG, high-grade lymphoma; LGG, low-grade glioma; NMA, network meta-analysis; PICOS, population, intervention, comparator, outcomes, and study design; SLR, systematic literature review.

4.1.4 Findings of the reviews

The cost-effectiveness review did not find any existing studies.

The utilities review did identify studies in adults that were used in the CS and are discussed in Sections 4.2.5.1.10 and 4.2.5.2.5. Albeit the EAG does have general concerns about using HRQoL from adults directly in a paediatric population. These concerns are given in greater detail in Section 4.3.7.3.

The cost review did not identify any evidence to directly inform the health state costs in the submitted model, so pathways were assumed, and standard UK reference sources were applied. More details on the assumed resource use and costs are given in Sections 4.2.5.1.124.2.5.2.6 and 4.2.5.2.7.

4.1.5 Conclusions of the cost effectiveness review

The company concluded that a de novo model should be developed to inform this appraisal.

4.2 Summary of the company's submitted economic evaluation

4.2.1 Population

There are two populations in this appraisal

- 1) Paediatric patients (age 1-17) with BRAF V600E mutation – positive LGG, eligible to receive first line systemic therapy (LGG population)

and

- 2) Paediatric patients (age 1-17) with BRAF V600E mutation positive HGG who are relapsed or refractory to first line systemic therapy (HGG population)

As discussed in Section 3.2.2, two different study designs were used to determine how effective D+T was in each of these populations, with an RCT being used in the LGG population and a prospective cohort study being used in the HGG population.

As key clinical evidence, the model structures and the comparators differ between the two populations, the description of the company's model and the data informing these models is split into the LGG and HGG subpopulations. For the EAG's critique we address issues in three categories, those that apply to both models, those that apply to the LGG model only and those that apply to the HGG model only. For the EAG's base case and exploratory analyses we again split our analyses into the LGG and HGG subpopulations.

The company submitted one executable software that could apply both models. This was implemented in Visual Basic for Applications code, augmented with parameter data and any necessary parameter calculations using Microsoft® Excel 365.

4.2.2 Interventions and comparators

4.2.2.1 LGG

4.2.2.1.1 Intervention

The intervention is D+T in line with the dosing given to patients in the TADPOLE LGG RCT.¹¹

4.2.2.1.2 Comparators

The comparator is C+V in line with the European treatment guidelines. This is discrepant with the regimen used in TADPOLE, where the US treatment regimens were used. The EAG's clinical experts believe that these regimens have similar efficacy, further details are given in Section 4.2.5.1.12.3, albeit the costs of the two regimens will differ.

Furthermore, the EAG notes that this is discrepant with the final scope, which specified that chemotherapies other than C+V should be considered.¹²

4.2.2.2 HGG

4.2.2.2.1 Intervention

The intervention is D+T in line with the dosing given to patients in the TADPOLE HGG prospective cohort study.¹¹

4.2.2.2.2 Comparators

The comparator is TMZ, if patients have not received TMZ as a 1st line systemic therapy (no prior TMZ subgroup), or BSC if TMZ has been received as a 1st line systemic therapy (prior TMZ subgroup). BSC consisted of health care contacts to manage pain, symptoms and deal with psychological distress, but no treatments. Further details on the definition of BSC is given in Section 2.3.3.2.

4.2.3 Perspective, time horizon and discounting

There are no significant differences in the perspective, time horizon or discounting in the two subpopulations (LGG and HGG). The perspective taken is that of the NHS personal and social services. The time horizon is 100 years. Discounting is conducted at a 3.5% per annum discount rate for both costs and QALYs.

4.2.4 Model structure

4.2.4.1 LGG

The schematic of the company's model for LGG is given in Figure 3. The company's model works in almost continuous time, rather than having time slices, as times are sampled continuously but are rounded to the nearest whole week.

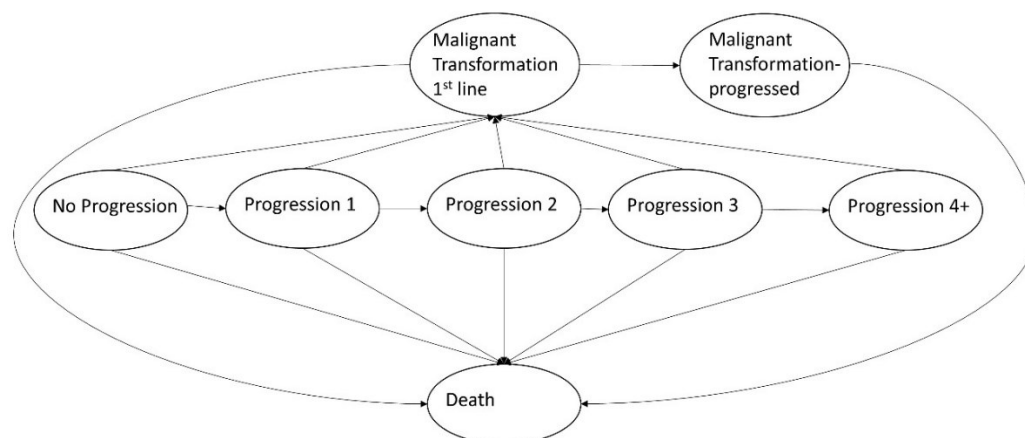
Figure 3: Schematic of the model for LGG patients

All patients start the model in the no progression health state and have their baseline characteristics of age, gender, weight and body surface area (BSA) sampled from the baseline characteristics in the TADPOLE LGG RCT. The following time to events are sampled for each patient: the time until all cause death; time to progressed LGG; time to malignant transformation (1st line treatment). The next event for the patient is determined by which event happens first. Death from all causes is sampled from a Gompertz time to event distribution fitted to ONS lifetables data (see Section 4.2.5.1.6.1); progression is sampled from the trial arm specific (D+T v C+V) local investigator defined PFS from the TADPOLE study (see Section 4.2.5.1.2); and, time to malignant transformation is sampled from an analysis of summary data reported in Kandels *et al.* (see Section 4.2.5.1.4).

If the patient's first event is death, they remain in the no progression health state for the rest of their life until they die.

If the patients experience a progression of LGG (i.e. the time of progression is before the time of death), they remain at risk of malignant transformation and all cause deaths. These time to events are left unchanged from the time to events sampled at baseline. However, two new events are sampled; the time to death post-progression (see Section 4.2.5.1.6.3) and the time until subsequent progression (see Section 4.2.5.1.3). The time to death post-progression is sampled from a distribution derived from Kandels *et al.*, the distribution differs depending on how quickly the patients experienced a progression.⁵¹ Once the time to death post-progression is sampled the time of death is updated to be the first of the time to all-cause mortality and time to death post-progression. The time to subsequent progressions is derived from Kandels *et al.*⁵¹ Upon further progression, the only additional time to event

that is sampled is the time until the next progression, with all previous times to events remaining the same. Again, the times to subsequent progressions are sampled from Kandels *et al.*⁵¹

If the patient experiences a malignant transformation (i.e. the time of malignant transformation is before the time of death) at any point in their disease course, this prevents them from having further LGG progressions. Patients with malignant transformation, could develop progressed malignant transformation and this was determined by data from the Jakacki *et al.* study using Event Free Survival (EFS) data. A probability of the EFS event being a death, rather than a progression, is taken from the TADPOLE HGG prospective cohort study. For the patients who have a progressed malignant transformation, they have a time of disease specific death sampled using data from post-progression survival in the TADPOLE HGG prospective cohort study. If the time of disease specific death is lower than the patients time of soonest death (all-cause mortality, or if they entered malignant transformation from a progressed LGG state time to mortality post progression (LGG)), their time of entering the death health state is updated to reflect the soonest death.

Time to treatment discontinuation for reasons other than disease progression or hitting the stopping rule duration (earliest of 3.71 years or reaching age 20) were taken from the RCT sub study in TADPOLE (LGG cohort). Once the events are ordered and the patient's flow through the model is determined, the company's model adopts a loop over the model weeks until the patient dies to attribute costs and QALYs to the patient's disease course.

4.2.4.2 HGG

Figure 4 shows the schematic of the model for the HGG population. This model is much simpler than a model used in the LGG population. Patients start the model in the progression free health state. Their time to progression is sampled from the ITC of TADPOLE and Verschuur *et al.*⁴⁵ Their time to death is sampled from the first of ONS all cause deaths. If patients progress before they die, it is estimated whether they die using data on the proportion of PFS events that were deaths from the TADPOLE HGG prospective cohort study. If the patient progresses rather than dies, they have their post progression survival estimated using an analysis of the TADPOLE HGG prospective cohort study. If this time is before the time of all cause death, the time of death is updated.

Figure 4: Schematic of the model for HGG patients (adapted from CS, Figure 18, page 92)

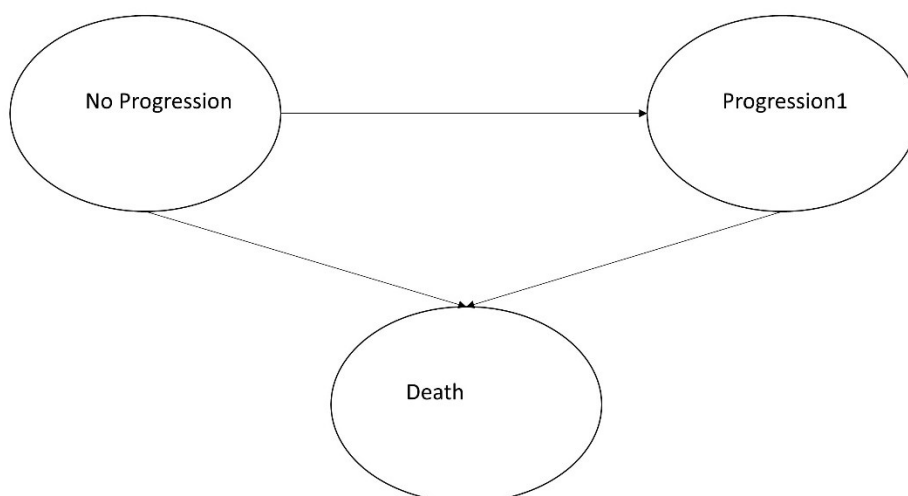

Again, after the events are ordered by the time they occur (and all events post-death are ignored), the company’s model loops over the model weeks until the patient dies to attribute costs and QALYs to the patient’s disease course.

4.2.5 Evidence used to inform the company’s model parameters

4.2.5.1 LGG

4.2.5.1.1 Baseline patient characteristics

The patient characteristics used in the model are taken from TADPOLE LGG RCT. A summary of these is given in Table 26. All patient characteristics were sampled from these distributions, apart from age which was sampled as a categorical variable, provided in Figure 5. All of these distributions were sampled independently, using normal distributions where standard deviations are reported or compare probability cut-offs to random numbers in instances where standard deviations are not reported, Table 26.

Table 26: The means and standard deviations used to sample patient characteristics (adapted from CS², Table 41)

Baseline characteristics	Mean	Standard Deviation
Age (years)	9.1	NA, categorical see Figure 5
% male	40.0%	NA
Weight (kg)	43.27	26.29
BSA (m ²)	1.26	0.51

NA, not applicable; kg, kilograms; BSA, body surface area; m², meters squared

Figure 5: Distribution of age for patients with low grade glioma

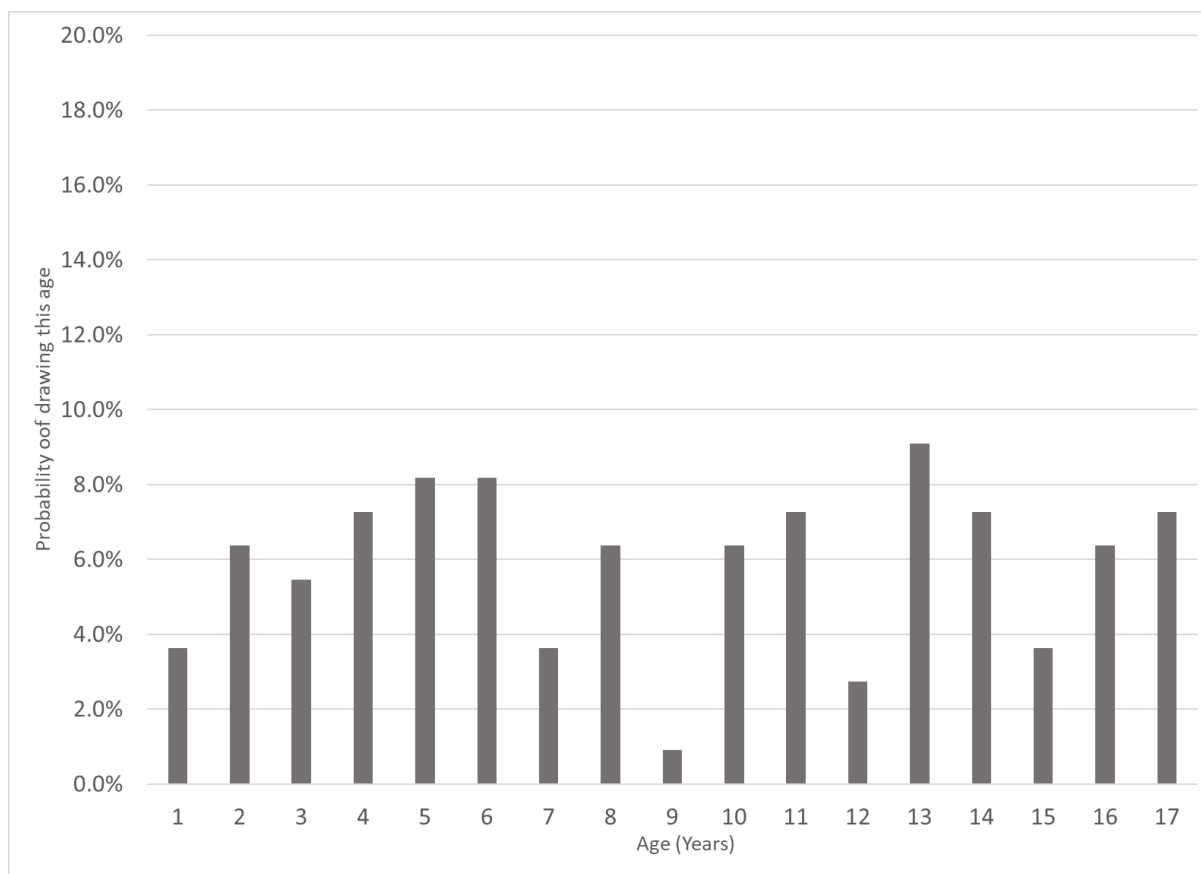

4.2.5.1.2 Time until disease progression or death (PFS)

In the company's base case, PFS evaluated by investigator assessment from the TADPOLE LGG RCT was used. To extrapolate the PFS data, a piecewise hybrid approach, consisting of using the Kaplan-Meier (KM) curve up to a fixed time point and then using a parametric model to extrapolate data, was adopted by the company. The extrapolated survival models for both C+V and D+T arm is shown in Figure 6.

For the C+V arm:

Phase 1 used the mean KM curves and lasted up until week 115.

Phase 2 used a lognormal extrapolation of the C+V PFS data up until the patient was 25.

Phase 3 after the patient was 25 and they had not progressed or died, then no progressions or deaths from the disease was allowed.

For D+T arm:

Phase 1 used the mean KM curves and lasted up until week 193.

Phase 2 used a lognormal extrapolation of the C+V PFS data up until the patient was 25.

Phase 3 after the patient was 25 and they had not progressed or died, then no progressions or deaths from the disease was allowed.

Figure 6: Survival extrapolation included in company's base case analysis, PFS LGG for the D+T and C+V arm (reproduced from CS² Figure 22)

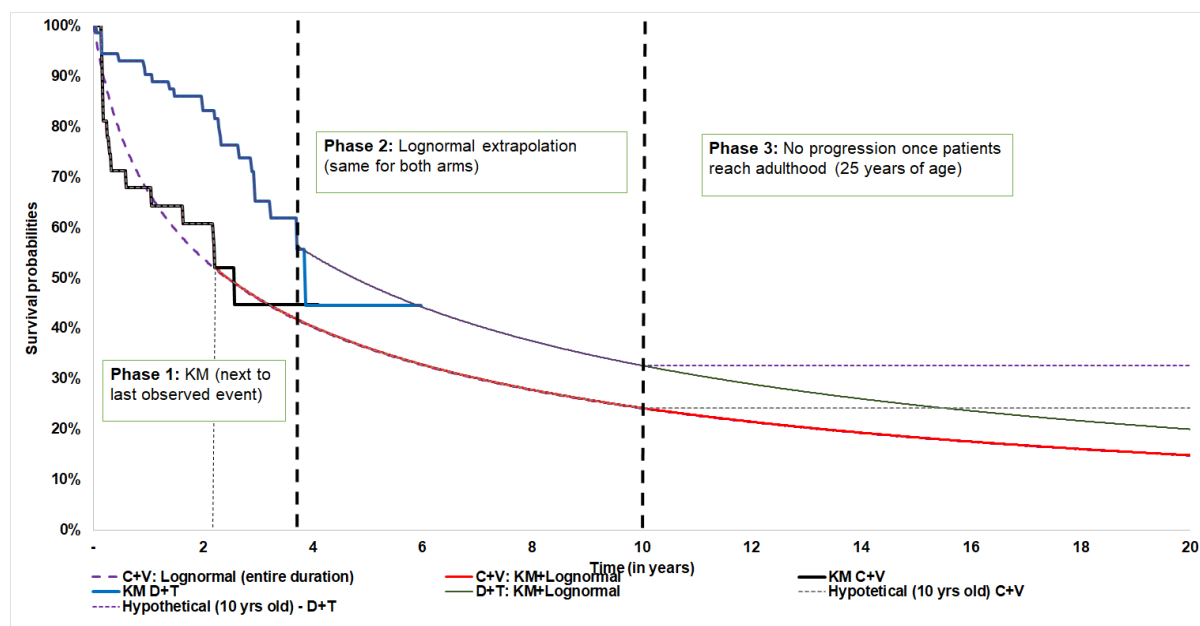

Source: Analysis of the TADPOLE trial.

Abbreviations: C, carboplatin; KM, Kaplan-Meier; PFS, progression-free survival, V, vincristine.

The company provides the following justifications for the hybrid approach used: (i) parametric models did not result in a good fit within the observed C+V period; (ii) the cut-off point for the base case was chosen due to the low number of patients at risk after 2 years; (iii) no progression was assumed once patient reach 25 years reflects clinical feedback.

In terms of choosing the parametric model, the company independently fitted a range of parametric models (exponential, Weibull, Gompertz, log-logistic, lognormal and generalised gamma) and a flexible model (spline hazard model with one-knot) to the C+V arm. The company states that the most appropriate model is chosen based on considering (i) visual fit to the KM data, (ii) statistical goodness-of-fit (measured using the Akaike information criterion [AIC] or Bayesian information criterion [BIC]); (iii) assessment of observed hazard, and (iv) the plausibility of the long-term extrapolation. The fitted models and goodness-of-fit statistics are presented in CS Appendix P. The reasons for selecting lognormal were (i) it provides the good statistical goodness-of-fit (lowest BIC); (ii) the long-term prediction aligned with Lassaletta *et al.*⁵², and clinical expectation.^{19, 20}

In response to clarification question B2,¹⁶ the company performed extrapolation for independent review assessed PFS for both D+T and C+V arm. This is discussed in detail in Section 4.3.2.1 of the EAG's critique, with the EAG's preferred approach to modelling PFS described in Section 4.4.2.

4.2.5.1.3 *Time to subsequent disease progressions*

Direct evidence on the time to subsequent disease progressions was not available. Therefore the company used data on the time until progression or death (investigator review) from the TADPOLE LGG RCT and an assumed HR estimated from summary data presented in Kandels *et al.*⁵¹ on the cumulative probability. The data used was “*the 3-year PFS following first-line chemotherapy (53.5%) and following second-line chemotherapy (20.6%) for patients with non-neurofibromatosis type 1 (NF1) cancer predisposition syndrome*” (CS², page 114).⁵¹ Hazards over 3 years were estimated, and the ratio of the hazards between those on 1st and subsequent lines of therapy was taken. This rate was assumed to apply to all subsequent lines of therapy.

The company took the same modelling approach (piecewise hybrid approach: KM followed by a lognormal distribution) to sampling the original time to progression or death to apply the HR to, as described in Section 4.2.5.1.2.

4.2.5.1.4 *Time to malignant transformation*

The time until malignant transformation was estimated using data presented in Gnekow *et al.*⁵³ This study stated that the rate of developing malignant transformation over 10 years was 0.18%. The company used this as the basis of an exponential distribution to sample the time of malignant transformation. Further, it was assumed that patients who had not developed a malignant transformation after 15 years could not develop a malignant transformation.

4.2.5.1.5 *Time to progressed malignant transformation*

The time until the progression of malignant transformation was estimated using data from Jakacki *et al.*⁵⁴ The ACNS0423 cohort received TMZ + CCNU after radiotherapy for their HGG. The event free survival curve for the ACNS0423 cohort in Jakacki *et al.* was digitised and the same range of parametric survival models as for the extrapolation of PFS were fitted.⁵⁴ The fitted models are presented in Figure 7 and goodness-of-fit statistics are presented in CS Appendix P.²

Figure 7: Survival extrapolation included in company’s base case analysis, EFS following malignant transformation, Jakacki 2016 (reproduced from CS² Figure 33)

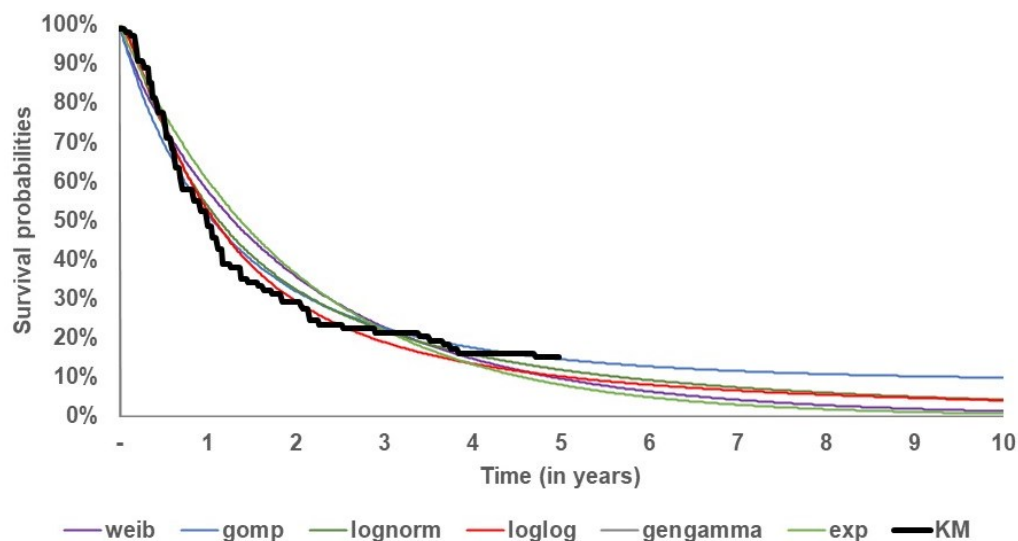

Source: derived from Jakacki 2016.

Abbreviations: EFS, event-free survival; exp, exponential; gengam, generalised gamma; gomp, Gompertz; KM, Kaplan-Meier; lnorm, lognormal; llog, log-logistic; weib, Weibull.

The company selected a Weibull distribution for their base case as “*it was associated with less of a plateau effect compared with other distributions*”. The EAG notes that the Weibull distribution does not fit the observed KM data well. The company explored using alternative distributions in scenario analysis and stated that this had modest impact on the ICER.

In response to clarification question B4,¹⁶ the company performed extrapolation using gamma and more flexible spline models. This is discussed in detail in Section 4.3.2.2 of the EAG’s critique, with the EAG’s preferred approach to model EFS described in Section 4.4.2.1.3.

4.2.5.1.6 Time to death

4.2.5.1.6.1 All causes

The model uses ONS data on age-gender adjusted mortality for England 2018-2020.⁵⁵ Separate Gompertz distributions were fitted to this data in the male and female population, as shown in Figure 8. A HR of 0.0000010 was inputted to attempt to adjust for baseline age, the EAG notes that the source of this HR is unclear.

Figure 8: Time to death from all causes used in the company’s model (replicated from CS², Figure 32)

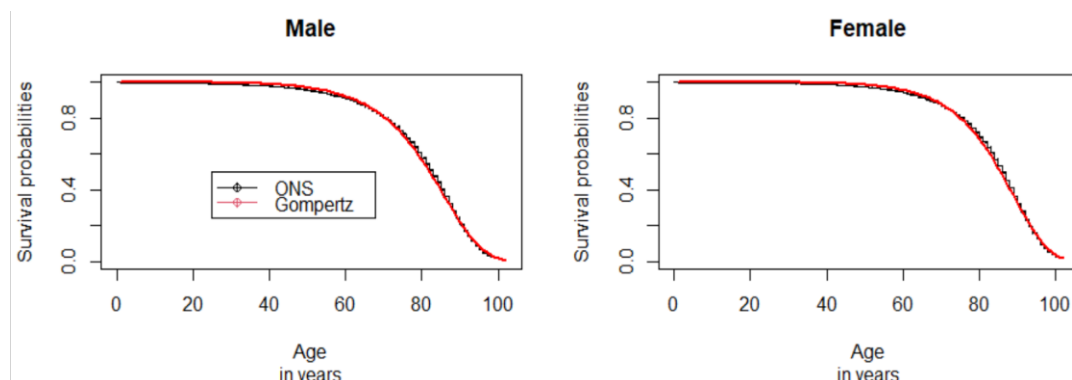

4.2.5.1.6.2 Time until Glioma specific death (pre LGG progression)

As there is only 1 death in the TADPOLE LGG RCT, patients in the company’s model could not die from glioma prior to their first progression. They could die from all-cause mortality.

4.2.5.1.6.3 Time to Glioma specific death (post- LGG progression)

Once the patient progresses, the company uses the available summary data from Kandels *et al.* to fit piecewise exponential models to estimate this time until death.⁵¹ These data shows that patients with LGG who have an early progression have significantly worse outcomes than those who progress later. The data for this is presented in Figure 9 below.

Figure 9: Survival probabilities for early (<18 month) and late progressors (≥18 months) used in the economic analysis, LGG (CS, Figure 25, page 109)

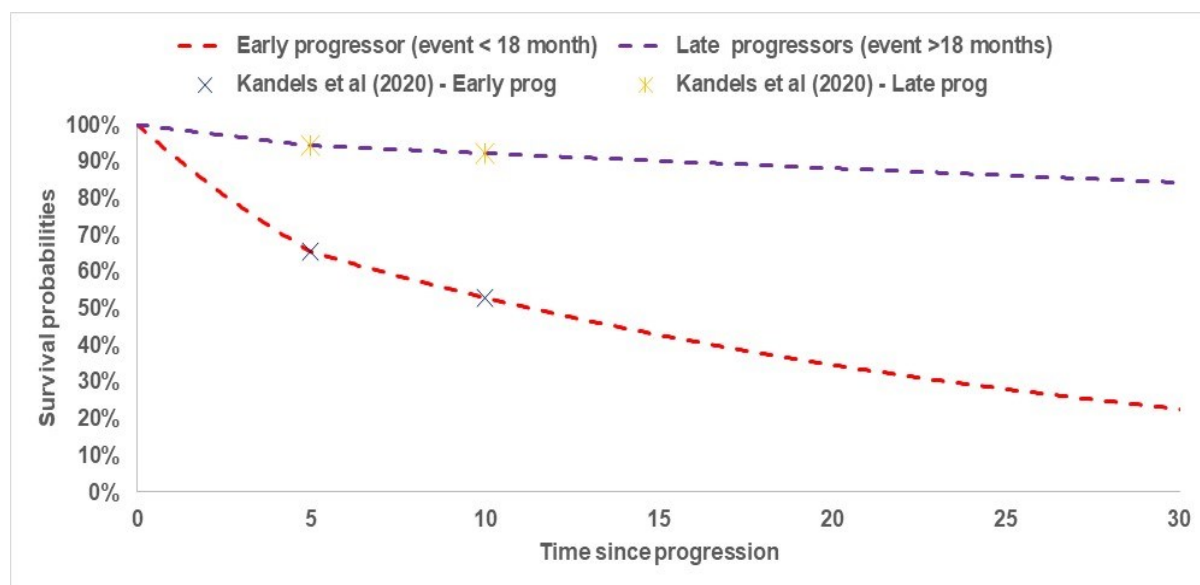

Source: Derived from Kandels *et al.* 2020⁵¹.
 Abbreviations: LGG, low-grade glioma; prog, progressors.

4.2.5.1.7 Time to Glioma specific death (post-malignant transformation)

No time to glioma specific death was sampled for people with a malignant transformation and who had not progressed. Instead, once patients experience an EFS event (see Section 4.2.5.1.5), the model applies a [REDACTED] probability of the event being a death event. The reason why the number of progression events [REDACTED] is discrepant with the number of patients informing the post progression survival time to event data $n = [REDACTED]$ is unclear. These data come from the events considered in the analysis of the time to the first of progression or death in the TADPOLE HGG prospective cohort study.¹¹

4.2.5.1.8 Time to Glioma specific death (post-progression after malignant transformation)

The company used the data on post-progression survival from the TADPOLE HGG prospective cohort study to estimate the time to glioma specific death after progression of a malignant transformation (with progression assessed by investigator assessment). The company fitted the same range of parametric models as for the extrapolation of PFS data. The same time to event was sampled in both arms of the LGG model analyses.

Figure 10 presents the fitted parametric model, and goodness-of-fit statistics are presented in CS Appendix P. The company chose an exponential distribution for their base case analysis, because it provides (i) a good visual fit; (ii) good goodness-of-fit statistics with the lowest BIC; (iii) long-term survival extrapolation reflects the poor prognosis following progression; and (iv) it was consistent with other distributions. Alternative models (Weibull, Gompertz, lognormal, log-logistic and spline) were explored in scenario analysis and had a modest impact on the ICER.

Figure 10: Survival extrapolation included in company's base case analysis, time to Glioma specific death (post-progression after malignant transformation), HGG, investigator assessed (reproduced from CS² Figure 27)

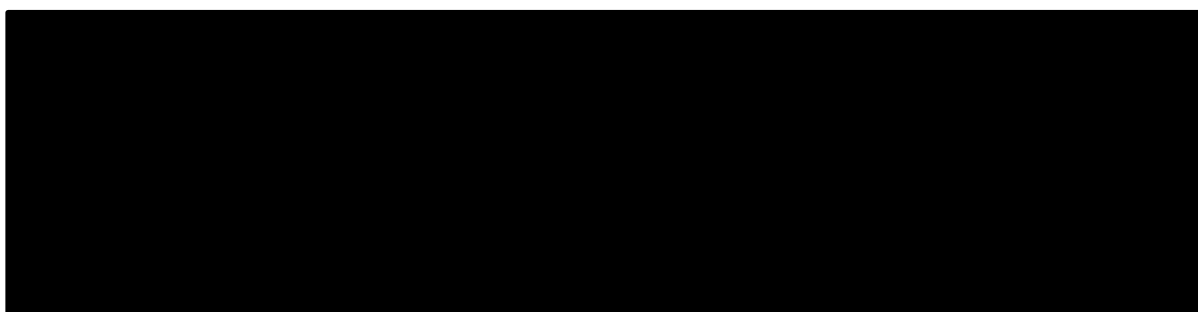

Source: Analysis of the TADPOLE trial.
Abbreviations: exp, exponential; KM, Kaplan-Meier; PPS, post-progression survival.

In response to clarification question B2,¹⁶ the company performed extrapolation for time to glioma specific death after progression of a malignant transformation (with progression assessed by

independent review). This is discussed in detail in Section 4.3.2.3 of the EAG's critique, with the EAG's preferred approach to modelling this outcome described in Section 4.4.24.4.2.1.4.

4.2.5.1.9 Time to treatment discontinuation

Patients were assumed to discontinue their D+T at the earliest of progression or death (PFS), at 3.71 years or upon independent treatment discontinuation. The time to progression or death is described in Section 4.2.5.1.2.

The discontinuation of D+T at 3.71 years assumption was included in the model, on the basis of the company's clinical experts believing that D+T would be stopped at 2 years – 5 years, based on stopping rules currently used for existing chemotherapies as this would avoid unnecessary treatment and potentially avoid some adverse events. (CS², page 115) This is implemented in the company's economic model as a stopping rule in which treatment will stop after 3.71 years. The EAG's clinical advisors had mixed opinions on the stopping rule, with one advisor thinking that stopping here was unlikely and the other thinking that as it stands most people would currently stop by (or at least have a drug holiday) at 3.71 years if they did not stop treatment due to AE's or progression. However, the other clinical advisor did note that this could change over time.

The time to discontinuation for other reasons was taken from data collected from the D+T arm of the TADPOLE LGG RCT. The company fitted the same range of parametric models as for the extrapolation of PFS data. Figure 11 presents the fitted parametric model and goodness-of-fit statistics are presented in CS Appendix P. The company chose the exponential distribution for their base case analysis, because (i) it provides the best statistical fit with the lowest AIC and BIC; (ii) a constant rate can be deemed more realistic considering the small number of events. Alternative models (Gompertz, lognormal, log-logistic) were explored in scenario analysis and had a minor impact on the ICER.

Figure 11: Survival extrapolation, TTD LGG for D+T (reproduced from CS² Appendix P)

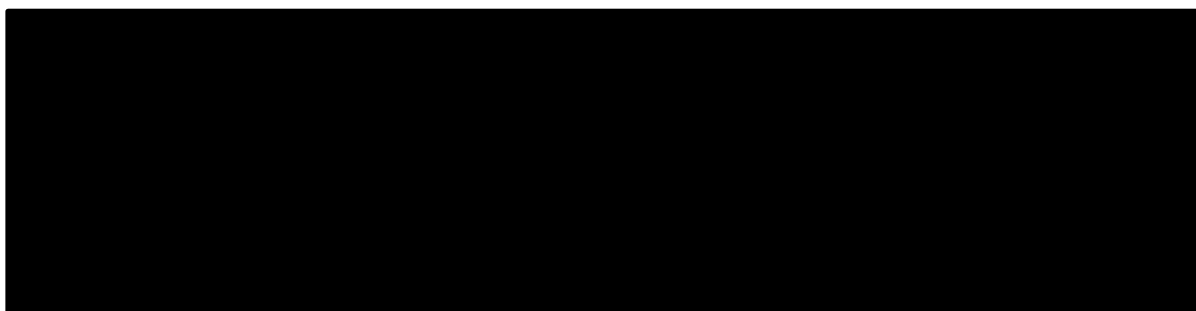

Abbreviations: exp, exponential; gomp, Gompertz; genGamma, generalised gamma; KM, Kaplan-Meier; llog, log-logistic; lnorm, lognormal; weib, Weibull.

4.2.5.1.10 Health state utility values

The (PROMIS) Parent Proxy Global Health 7.2 instrument was used to measure the health-related quality of life (HRQoL) in the LGG cohort during the TADPOLE LGG RCT; however, no EQ-5D domain data were collected. The company used external literature, of utilities in adult patients with Glioma identified from a systemic review (see Section 4.1).

Utility decrements were applied to the age-gender norms to calculate health state utilities in their model. This means that there is consistent utility penalty to moving to a worse health state, regardless of the patient's starting health. The methods guide does specify in point 4.3.7, that utility multipliers are NICE's generally preferred approach to adjust age-gender norms in utility to health state utilities.⁵⁶ The company provides their justification for their approach of using utility decrements in response to clarification question B18.¹⁶ For the full justification, the clarification response to question B18 should be read. In summary, the EAG based on the response to clarification question B18 believes that the key reasons why the company used decrements were:

1. They allow a constant utility decrement to be applied, regardless of when a progression occurs.
2. This approach is adopted in other economic models, in CVD and diabetes.

The company makes some other points in their response to clarification question B18, but the EAG believes these are more generally relevant to reducing utilities by age, rather than if the age-gender norms in utility should be adjusted to health state utilities using multipliers or decrements.¹⁶

The EAG notes that using decrements rather than multipliers is likely to reduce the amount of HRQoL lost in the economic model. A multiplicative approach and a decrement approach should give the same answer, when applied to the same age-gender norm utility. Age-gender norms in HRQoL are typically higher, the younger someone is in the Hernandez *et al.* results.¹ Therefore we would expect absolute utility losses to be lower in the company's approach of using decrements in this appraisal, especially as the mean age of the population in the model is 9.1 years old but the mean or median age of the

populations that the utility decrements are estimated in range from 46.7 years old (Drewes *et al.*⁵⁷) to 52 years old (Vera *et al.*⁵⁸) (see Table 27).

The utility values used in the LGG model are summarised in Table 27. Full details and descriptions of the sources are given in Sections 4.2.5.1.10.1 to 4.2.5.1.10.4.

Table 27: A summary of utility values used in the LGG population

Health State	Mean	Standard error	Sources
Age – gender population norms	See supplementary Excel file in Hernandez Alava <i>et al.</i> ¹	Assumed no uncertainty	Hernandez Alava <i>et al.</i> ¹
Change in utility compared to age-gender norms			
LGG pre progression	-0.155	*0.0155	Drewes <i>et al.</i> ⁵⁷ , Janssen <i>et al.</i> ⁵⁹ & Vera <i>et al.</i> ⁵⁸
Change in utility for further disease progression			
Change in utility for each further progression	-0.06	0.020	Vera <i>et al.</i> ⁵⁸
Change in utility for further progressions compared to age gender norms			
Progression 1	-0.215	NA	LGG preprogression + 1*change in utility per further progression
Progression 2	-0.275	NA	LGG preprogression + 2*change in utility per further progression
Progression 3	-0.335	NA	LGG preprogression + 3*change in utility per further progression
Progression 4	-0.395	NA	LGG preprogression + 4*change in utility per further progression
One off QALY losses			
Chemotherapy related disutility	0.187	0.0187*	Hadi <i>et al.</i> ⁶⁰

C+V, AE related QALY loss	0.00280	0.000280*	TADPOLE LGG RCT ¹¹ , TA772 ⁶¹
Annual utility decrements			
D+T, AE related utility decrement	0.00082	0.000082*	TADPOLE LGG RCT ¹¹ , TA772 ⁶¹
Changes in utility associated with developing a malignant transformation, compared to pre malignant transformation utility – for further details see			
Utility decrement – receiving 1 st line treatment for malignant transformed glioma	-0.155	*0.0155	Vera <i>et al.</i> ⁵⁸ & Janssen <i>et al.</i> ⁵⁹
Weekly utility loss – developed a progressed malignant transformed glioma	1.1%	0.11%*	Drewes <i>et al.</i> ⁵⁷ & Calculation

* Standard error was assumed to be the absolute value of 10% of the mean

LGG, low grade glioma; NA, not applicable; QALY, quality adjusted life years; C+V, carboplatin and vincristine; AE, adverse event

4.2.5.1.10.1 Age gender population norms

Age-gender norms for utility were taken from the NICE DSU analysis of the 2014 health survey for England, with utilities whilst under 16 being set the utility for a 16 year old.¹ No uncertainty was included in the age-gender norms in the company's base case analysis (Clarification Response¹⁶, Question B15), this should remain to be the base case as neither the company or the EAG could satisfactorily include the uncertainty in the regression coefficients using the provided covariance matrix.

4.2.5.1.10.2 Pre-progression utility

To estimate the utility for someone with LGG before they experienced a progression, the company applied a utility decrement of 0.155 to the age gender norms for utility for that patient, which was based on three studies, as study in adults with LGG by Drewes *et al.*, age-gender population norms in Janssen *et al.*, and the application of a decrement for 1st progression in Vera *et al.*⁵⁷⁻⁵⁹

The median utility reported in Drewes *et al.* for LGG patients at baseline was 0.76.⁵⁷ Drewes *et al.* was study of 40 Norwegian LGG patients undergoing first time surgery for glioma whose mean age was 46.7 years and of whom 32.5% were female.⁵⁷ Drewes *et al.* used the EQ5D3L and used the UK value set to calculate utility scores.^{62, 63}

The company assumed an age gender norm of utility for these patients of 0.855, which was taken by matching the mean age in Drewes *et al* (46.7 years old) to the results of Janssen *et al*.^{57, 59} Janssen *et al*., was a study of age norms in 11 countries, using multiple cross sectional surveys in different countries.⁵⁹ Janssen used the EQ5D3L and used the UK value set to derive age-gender norms in utility.^{62, 63} However, the value used by the company was established to be the US value set in response to clarification question B17, however this may be due to some confusion as the company's response only refers to HGG.^{16, 64} The EAG notes that in the 45-55 age group in Janssen *et al*, the US and UK value set analyses in Jansen *et al* produce the same values for utility to the reported 3 decimal places.

The decrement from these two sources was calculated as $0.855 - 0.76$, which equals 0.095. The company added on an additional decrement of 0.06, which was taken from an analysis of LGG progression data in Vera *et al*. Details of the source of this decrement is given in Section 4.2.5.1.10.3. The company's rationale for applying this decrement is that patients with LGG will only receive first line systemic therapy after a patient has had a progression in the observation period after a surgery that did not result in a successful complete resection of the tumour (see Section 2.2.1). Therefore, patients receiving first line systemic therapy have had one progression. The EAG agrees with this logic.

Drewes *et al*. only presented information on the range of ED5D index values, and Janssen *et al*. reported no uncertainty information, so the company assumed at standard error of 10% of the mean in the probabilistic analyses (Clarification Response¹⁶, Question B16).^{57, 59}

4.2.5.1.10.3 Post-progression utility

To get to the utility for someone with LGG after they experienced a progression, but had not malignantly transformed to HGG the company applied a further decrement of 0.06 per LGG progression. This data was taken from Vera *et al*., which is a retrospective cohort study of 336 patients with malignant glioma in the US National Cancer Institute NeuroOncology Branch Natural History Study.⁵⁸ 112 patients had a progression between follow up observations, with progression being defined by radiography findings. It was unclear whether any central review of progression was conducted or whether progression was determined solely by local physician decisions. EQ-5D-3L was collected between September 2016 and January 2020 and was turned into utility values using the US value set.^{62, 64} In the overall cohort, the median age was 52 years old and the population was 64% male, albeit the characteristics of the population who had valid utilities are unknown.⁵⁸ Uncertainty was included in this decrement in the CS, as a 95% confidence interval that could be used to parameterise a distribution for the probabilistic analysis was reported in Vera *et al*.⁵⁸

4.2.5.1.10.4 Malignant transformation

See Section 4.2.5.2.5.2 for malignant transformation utilities and Section 4.2.5.2.5.3 for progressed malignant transformation utilities.

4.2.5.1.11 One off QALY losses

4.2.5.1.11.1 Chemotherapy related disutility

A one off QALY loss for being in the comparator arm (C+V) is applied in the company's model. This is primarily taken from Hadi *et al*, which was a bespoke time trade off study in the UK general population evaluating the impact of various changes in health condition for people with Gaucher disease.⁶⁰ Hadi *et al*. respondents had a mean age of 34.5 years old and 66% of whom were female.⁶⁰ Hadi *et al*. found that oral administration was associated with a mean TTO utility value of 0.85 with a standard deviation of 0.15 and intravenous administration with a mean TTO utility value of 0.73 with a standard deviation of 0.20, a difference in means of 0.12. As C+V should be applied for 81 weeks, the company calculated a one off QALY loss of 0.187, which is equal to everyone in the C+V arm having these utility losses for a full 81-week treatment course even if they received a shortened course of treatment. There was no reported uncertainty in this decrement, so the standard error was assumed to be 10% of the mean. (Clarification Response¹⁶, Question B16)

4.2.5.1.11.2 Adverse Events

The grade 3/4 AE incidence rates associated with C+V were obtained from the TADPOLE LGG RCT and for D+T were obtained from the TADPOLE LGG RCT and the TADPOLE HGG prospective cohort study as reported in the CS. The results are reported below in Table 28.^{2,38} These incidence rates were used to inform the QALY losses due to adverse events and the costs of treating adverse events.

Table 28: LGG adverse effect incidence rates associated with treatment (modified from Table 44 in CS²)

Adverse event	Incidence	
	D+T (n = 114)	C+V (n = 33)
Neutrophil count decreased	████	████
White blood cell count decreased	████	████
Alanine aminotransferase increased	████	████
Lymphocyte count decreased	████	████
Platelet count decreased	████	████
Blood creatine phosphokinase increased	████	████
Gamma-glutamyltransferase	████	████
Hypomagnesaemia	████	████
Aspartate aminotransferase increased	████	████

Adverse event	Incidence	
	D+T (n = 114)	C+V (n = 33)
Ejection fraction decreased	████	████
Amylase increased	████	████
Lipase increased	████	████
Pancreatitis	████	████
Hypersensitivity	████	████
Abdominal infection	████	████
Device related infection	████	████
Infusion related reaction	████	████
Viral infection	████	████
Rash	████	████
Urticaria	████	████
Flushing	████	████
Hypertension	████	████
Hypotension	████	████
Headache	████	████
Dizziness	████	████
Pyrexia	████	████
Gastrointestinal Haemorrhage	████	████
Diarrhoea	████	████
Agitation	████	████
Confusional state	████	████
Peripheral motor neuropathy	████	████
Peripheral sensory neuropathy	████	████
Uterine haemorrhage	████	████
Anaemia	████	████
Neutropenia	████	████
Thrombocytopenia	████	████
Weight increased	████	████
Uveitis	████	████
Vomiting	████	████
Influenza like illness	████	████
Brain oedema	████	████

D+T: dabrafenib plus trametinib; C+V: carboplatin plus vincristine

4.2.5.1.11.3 Disutility associated with adverse events

The CS uses disutility values associated with grade 3/4 AEs that have been taken from a regression analysis conducted as part of TA772 which concluded that a disutility of 0.075 applicable over a period

of 7 days was correct for grade 3 or 4 AE.^{2, 61} This means that AEs in this appraisal were also assumed to resolve in 7 days.

The CS assumes that AEs associated with C+V were likely to have been captured in the TADPOLE LGG RCT, therefore the occurrence of AEs were multiplied by the TA772 decrement to give a one off utility decrement applied at the start of the model.^{2, 61} This gives a QALY decrement of 0.00280.

For D+T, treatment could go beyond the trial duration. The incidence of AEs for D+T were adjusted for exposure and applied in the model using an annual decrement of 0.00083.² This was calculated by adjusting the AE incidence rates for the time spent on treatment to get an annualised incidence rate. At which point, the calculation was the same as it was in the D+T arm.

4.2.5.1.12 Resource use, unit costs and costs

The model includes the following cost components: (i) costs associated with drug acquisition; (ii) costs associated with drug administration; (iii) costs associated with monitoring; (iv) costs associated with the disease progression; (v) costs associated with the management of AEs; and (vi) costs associated with end-of-life care. A summary of the model cost parameters and their derivation is shown below.

4.2.5.1.12.1 Drug acquisition costs

4.2.5.1.12.2 Intervention costs and dosing

The list price for dabrafenib (420 dispersible tablets of 10 mg) and trametinib (4.7 mg bottle) are not yet available on the British National Formulary (BNF) however, they are anticipated to be [REDACTED] and [REDACTED] respectively. A Patient Access Scheme (PAS) has been submitted which will reduce the NHS cost of dabrafenib (420 dispersible tablets of 10 mg) to [REDACTED] and reduce the NHS cost of trametinib to [REDACTED].

The dose of the D+T treatments were taken from a regression analysis of the dose of dabrafenib and trametinib by age and gender used in the D+T arm of the TADPOLE LGG RCT. The data on this is given in Table 29. These doses do not account for any wastage of dabrafenib or trametinib in the treatment regimen (Clarification Response¹⁶, Question B13). When the EAG's clinician advisors did comment on wastage of either D+T, they commented on the wastage of the comparator chemotherapy regimens and did not comment on any potential wastage of dabrafenib or trametinib. As D+T are at home regimens any wastage would only be around breakage/spillage of trametinib and loss of dabrafenib doses. There would not be the same issues as chemotherapies around vial wastage, were whole vials are used for each patient.

Table 29: The regression formulae used to predict the dose of intervention (in mg) treatments in the company’s economic model for low grade glioma patients receiving Dabrafenib and Trametinib

	Mean	Distribution	Covariance	Source
Dabrafenib				
Constant	████	Multivariate	████ █████ █████	CS ² , company’s model
Gender (1 = male, 0 =female)	████	Normal	████ █████ █████ ████ █████ █████	
Ln(Age in years)	████			
Trametinib				
Constant	████	Multivariate	████ █████ █████	CS ² , company’s model
Gender (1 = male, 0 =female)	████	Normal	████ █████ █████ ████ █████ █████	
Ln(Age in years)	████			

4.2.5.1.12.3 Comparator costs

For costs, the doses of C+V are based on European treatment guidelines. This differs from the TADPOLE LGG RCT, in which patients were given C+V in line with American guidelines. The EAG believes this is appropriate, as our clinical experts believed that the two chemotherapy regimens would have very similar efficacy and AE profiles – but the costs in a UK setting would use the European guidelines. Although the EAG notes that as this is a rare condition it would be very difficult to find or generate evidence to support these beliefs. The assumed doses are given in Table 30 and the prices of treatments are given in Table 31.

Table 30: Dosage for the comparator treatments

Drug regimen	Drug	Dose
Carboplatin plus vincristine	Carboplatin	Induction therapy (weeks 1-24) IV: 550mg/m ² in weeks 1, 4, 7, 10, 13, 17 & 21 Consolidation therapy (8 x 8-week cycles (6 weeks of treatment followed by 2 weeks of rest)) IV: 550 mg/m ² in week 1 of each cycle
	Vincristine	Induction therapy (weeks 1-24) IV: 1.5 mg/m ² (max 2 mg) in weeks 1, 2, 3, 4, 5, 6, 7, 8, 9, 10, 13, 17 & 21 Consolidation therapy (8 x 8-week cycles (6 weeks of treatment followed by 2 weeks of rest)) IV: 1.5mg/m ² (max 2 mg) in weeks 1, 2 & 3 of each cycle
Vinblastine (2nd line)	Vinblastine	IV: 5 mg/m ² every week for 70 weeks
Bevacizumab plus irinotecan (3rd line)	Bevacizumab	IV: 10 mg/kg twice weekly for 52 weeks
	Irinotecan	IV: 125 mg/m ² twice weekly for 52 weeks
TPCV (4th line)	Tioguanine	IV: 30 mg/m ² in week 1 of a 6-week cycle (max 8 cycles)
	Procarbazine	IV: 200 mg/m ² in week 1 of a 6-week cycle (max 8 cycles)
	Lomustine	IV: 110 mg/m ² in week 1 of a 6-week cycle (max 8 cycles)
	Vincristine	IV: 1.5 mg/m ² in weeks 2 & 4 of a 6-week cycle (max 8 cycles)

IV, intravenous; mg: milligram; mg/kg milligram per kilogram; mg/m²: milligram per square meter; max: maximum; TPCV: tioguanine + procarbazine + lomustine + vincristine

Table 31: List and NHS prices for the intervention and comparator drugs

Drug	Dose per unit	Formulation	Pack size	List price	Price in the economic model	Source
Dabrafenib	10 mg	Tablet	420	■	■	CS ²
Trametinib	4.7 mg	Bottle	1	■	■	CS ²
Carboplatin	600 mg	Vial	1	£21.32	£21.54	eMIT ⁶⁵
Vincristine	2 mg	Vial	5	£41.69	£33.89	eMIT ⁶⁵
Vinblastine	10 mg	Vial	5	£83.59	£83.97	eMIT ⁶⁵
Bevacizumab	400 mg	Vial	1	£810.10	£810.10	BNF ⁶⁶
Irinotecan	100 mg	Vial	1	£130.00	£12.83	eMIT ⁶⁵
Tioguanine	40 mg	Vial	25	£76.35	£76.35	CMU ⁶⁵
Procarbazine	50 mg	Capsule	50	£503.61	£503.61	CMU ⁶⁷
Lomustine	40 mg	Capsule	20	£780.82	£780.82	BNF ⁶⁶

CS, company submission; eMIT, electronic market information tool; BNF, British National Formulary; CMU, commercial medicines unit

According to the company submission an additional cost of £349.40 (associated with the procurement of chemotherapy drugs in band six) at each cycle was included in the model. The cost was taken from NHS reference costs, currency code SB06Z.⁶⁸

The company's model takes the approach that there is no wastage of treatments. The EAG's clinical advisors noted that for the comparators that whole vials would be used most of the time when giving chemotherapy, so there would be some wastage of these vials. This is because paediatric glioma is very rare in the UK, so there would be minimal opportunity for vial sharing. The EAG's clinical advisors did not comment on the use of trametinib, however the same concerns are unlikely to apply to the same extent for trametinib, as whilst it is in a bottle, it is an oral therapy given at home.

4.2.5.1.12.4 Drug administration

The company submission sets out the costs of administration.² However, they have been tabulated below for quick reference, see Table 32.

Table 32: Costs associated with the administration of investigated chemotherapy treatments

Drug regimen	Method of administration	Cost	Source
Dabrafenib plus trametinib	Oral	£0.00	-
Carboplatin plus vincristine	Complex chemotherapy: First dose: Day case SB14Z Subsequent doses: Day case SB15Z	£485.23 £383.54	NHS Ref Costs ⁶⁸
Vinblastine	Simple chemotherapy (day case): First dose: Day case SB	£313.91	NHS Ref Costs ⁶⁸

	Subsequent doses: Day case SB15Z	£383.54	
Bevacizumab plus irinotecan	Complex chemotherapy: First dose: Day case SB14Z Subsequent doses: Day case SB15Z	£485.23 £383.54	NHS Ref Costs ⁶⁸
Tioguanine plus procarbazine plus lomustine plus vincristine	Complex chemotherapy: First dose: Day case SB14Z Subsequent doses: Day case SB15Z	£485.23 £383.54	NHS Ref Costs ⁶⁸

NHS, national health service

4.2.5.1.13 Monitoring and testing costs

The CS provides monitoring and testing costs for D+T and C+V, which were based on the Children's Cancer and Leukaemia group (CCLG) guideline.^{2, 18} These are not provided for the subsequent therapy lines. A summary of the frequency of visits and the assumed unit costs are given below in

Table 33.

Table 33: The frequency and unit costs for monitoring visits and test costs, whilst on treatment up until 84 weeks post-treatment commencement (adapted from CS², Table 48 and 49, pages 130-131)

	C+V	D+T	Unit Cost	Source
Clinical Examination	Every 3 weeks (week 1-24), then every 6 weeks	Every 4 weeks (week 1-24), then every 8 weeks	£316.49	NHS Ref Costs ⁶⁸ , WF01A (Consultant led), Non-Admitted Face-to-Face Attendance, Follow-up
Full blood count			£5.74	NHS Ref Costs ⁶⁸ , DAPS03 + DAPS09
Ophthalmological assessment	Week 12, then every 12 weeks	None	£130.65	NHS Ref Costs ⁶⁸ WF01A-WF02C (consultant led): Paediatric Ophthalmology Service
GFR	Week 24, 54 and 84	None	£688.89	NHS Ref Costs ⁶⁸ RN25B-C, Glomerular Filtration Rate Testing
Audiology assessment			£390.41	NHS Ref Costs ⁶⁸ , WF01A (consultant led): Paediatric Audio Vestibular Medicine Service; NonAdmitted Face-to-Face Attendance, Follow-up
MRI			£222.16	NHS Ref Costs ⁶⁸ , weighted average (RD01B, RD01C, RD02B): Magnetic Resonance Imaging
ECG	None	Week 12, then every 12 weeks	£69.90	NHS Ref Costs ⁶⁸ , EY50Z - Complex Echocardiogram
Echocardiogram			£74.61	NHS Ref Costs ⁶⁸ , EY51Z - Electrocardiogram Monitoring or Stress Testing

C+V, carboplatin + vincristine; D+T, dabrafenib+ trametinib ; NHS ref costs, NHS reference costs; GFR, glomerular filtration rate; MRI, magnetic resonance imaging

4.2.5.1.14 Disease progression

4.2.5.1.14.1 Progressed LGG

The company submission sets out the costs associated with subsequent treatment modalities at first second third and fourth progression where applicable.² The company's resource use are replicated below in Table 34. It is possible for patients to receive no treatments as their systemic therapy, this would be determined by their local MDT.

Table 34: Treatments used at each LGG progression and their associated costs (replicated from CS², Table 50, page 132)

Description	Surgery	Radiotherapy / PBT	Chemotherapy	Cost following progression
First progression	11.3%	25.3%	51.0%	£26,107
Second progression	11.6%	22.1%	57.0%	£29,497
Third progression	5.4%	12.5%	37.5%	£10,329
Fourth progression	20.0%	20.0%	100.0%	£22,950

PBT: Proton beam therapy

4.2.5.1.14.2 Cost of treating patients with a malignant transformation

First-line malignant transformation of low grade gliomas into high grade gliomas is rare in paediatric patients and the CS² states that the associated costs are unlikely to have an impact on cost-effectiveness results. Malignant transformation is associated with a one-off cost of £16,293 comprising of the costs of adjuvant TMZ, radiotherapy and carmustine implants.⁶⁹

4.2.5.1.14.3 Cost of treating patients with a progressed malignant transformation

The CS does not state that there are any costs associated with progressed malignant transformation in the submitted model, so these costs are assumed to be included in the £16,293 incurred upon initial malignant transformation.²

4.2.5.1.15 Adverse events costs

For LGG patients receiving C+V costs associated with grade 3/4 AEs were incorporated at model entry as most AEs had been captured within the study period the frequency of each adverse event category was multiplied by the unit cost to give one-off cumulative AE costs of £6,744 for LGG patients receiving C+V. For patients receiving D+T treatment duration went beyond that observed in the study period and consequently had to be extrapolated while adjusting for exposure and applied in the model during treatment. The costs associated with AEs is presented below in

Table 35.

Table 35: Costs associated with adverse events (modified from CS², Table 52, pages 134-135)

Adverse event	Detailed description	Cost	Source
Neutrophil count decreased	PG71A: Paediatric hepatobiliary or pancreatic disorders	£3,062	NHS Ref Costs ⁶⁸
White blood cell count decreased			
Alanine aminotransferase increased			
Lymphocyte count decreased			
Platelet count decreased			
Blood creatine phosphokinase increased			
Gamma-glutamyltransferase			
Hypomagnesaemia			
Aspartate aminotransferase increased			
Ejection fraction decreased			
Amylase increased			
Lipase increased			
Pancreatitis			
Hypersensitivity	PW01A: Paediatric minor infections	£1,476	NHS Ref Costs ⁶⁸
Abdominal infection			
Device related infection			
Infusion related reaction			
Viral infection			
Rash	PJ66A: Paediatric, rash or other non-specific skin eruption	£704	NHS Ref Costs ⁶⁸
Urticaria			
Flushing			
Hypertension	EB04Z Hypertension	£770	NHS Ref Costs ⁶⁸
Hypotension			
Headache	PR04A Paediatric, headaches or migraines	£1,116	NHS Ref Costs ⁶⁸
Dizziness			
Pyrexia			
Gastrointestinal Haemorrhage	PF26A Paediatric other gastrointestinal disorders	£1,542	NHS Ref Costs ⁶⁸
Diarrhoea			
Agitation	PT52A Paediatric behavioural disorders	£2,200	NHS Ref Costs ⁶⁸
Confusional state			
Peripheral motor neuropathy	PX29A Paediatric abdominal pain	£861	NHS Ref Costs ⁶⁸
Peripheral sensory neuropathy			
Uterine haemorrhage			
Anaemia	SA03G Haemolytic anaemia	£1,519	NHS Ref Costs ⁶⁸
Neutropenia	PM45A Paediatric febrile neutropenia with malignancy	£10,303	NHS Ref Costs ⁶⁸
Thrombocytopenia	SA12G Thrombocytopenia	£993	NHS Ref Costs ⁶⁸

Adverse event	Detailed description	Cost	Source
Weight increased	PK72A Paediatric metabolic disorders	£740	NHS Ref Costs ⁶⁸
Uveitis	PP64A Paediatric non-surgical ophthalmology	£1,375	NHS Ref Costs ⁶⁸
Vomiting	PF28A Paediatric feeding difficulties or vomiting	£1,480	NHS Ref Costs ⁶⁸
Influenza like illness	PW20A Paediatric fever of unknown origin	£1,431	NHS Ref Costs ⁶⁸
Brain oedema	PC63A Paediatric head neck or ear disorders	£978	NHS Ref Costs ⁶⁸

4.2.5.1.16 End-of-life care costs

The company assumed a one-off end-of-life care cost of £8,369 per patient which is applied in the model at time of death. This data was sourced from a report by the Nuffield Trust.⁷⁰

4.2.5.2 HGG

4.2.5.2.1 Baseline patient characteristics

The baseline characteristics came from the TADPOLE HGG prospective cohort study. A summary of these is given below in Table 36. All patient characteristics were sampled from these distributions, apart from age, which was sampled as a categorical variable, with the distribution provided in

Figure 12.

Table 36: The means and standard deviations of the patient characteristics in the high grade glioma economic model (adapted from CS², Table 41, page 101)

Baseline characteristics	Mean	Standard Deviation
Age	12.12	NA, see Figure 14
% male	43.9%	NA
Weight (kg)	49.82	27.38

NA, not applicable; kg, kilogram

Figure 12: The distribution of age for patients in the high-grade glioma economic model

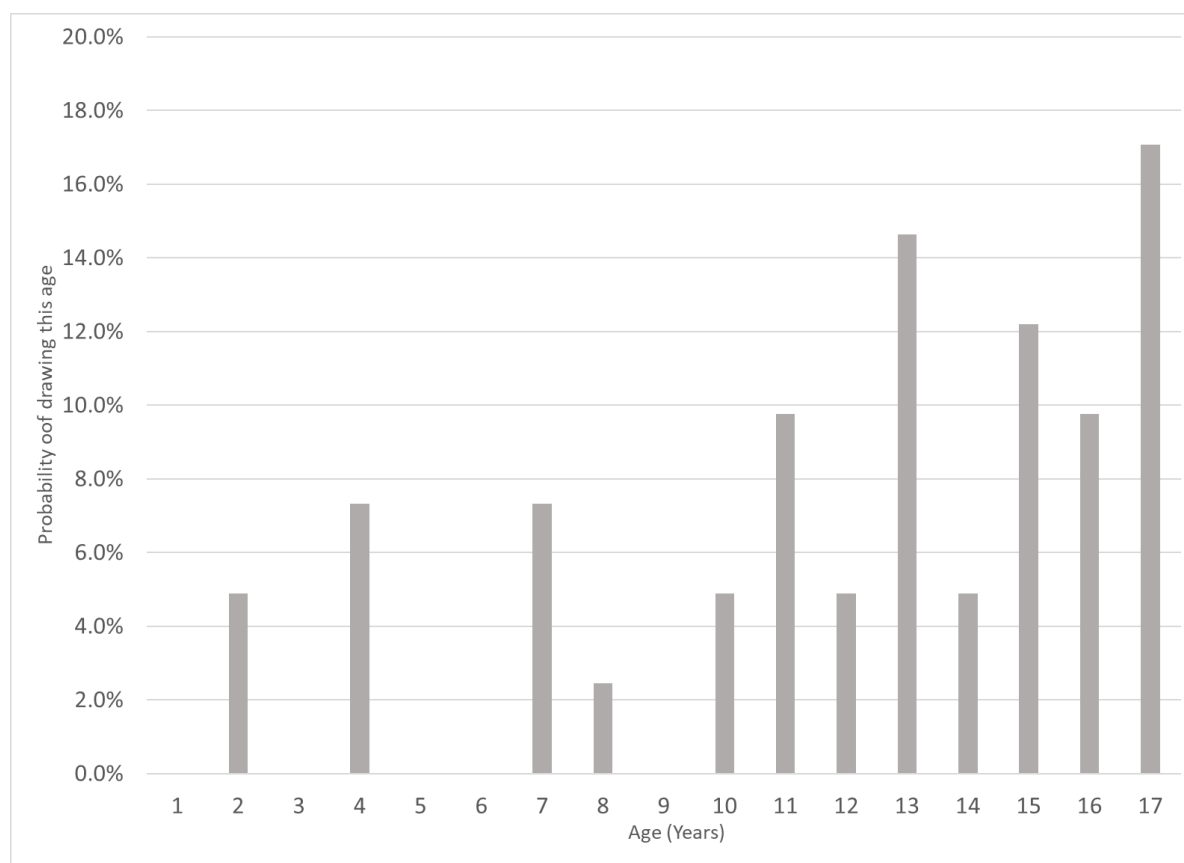

4.2.5.2.2 Time to progression or death (PFS)

In the company’s base case, PFS evaluated by investigator assessment from the TADPOLE HGG prospective cohort study was used for the D+T arm. The HGG population was further split into the two subgroups of previously treated with TMZ (prior TMZ) and not previously treated with TMZ (no prior TMZ).

A piecewise hybrid approach similar to the approach used for the LGG population, consisting of the KM curve and a parametric model was used to extrapolate the data. The KM curves were used in until the next to last event (105 weeks for the prior TMZ subgroup and 143 weeks for the no prior TMZ subgroup) in the company’s base case with the time to PFS after this point being derived from an exponential curve. The cut-off points for using the KM was justified by the company as there were low numbers of at risk patients after 2 years.² Figure 13 presents the modelled PFS for the prior TMZ and no prior TMZ subgroups.

The justifications for the piecewise hybrid approach given by the company are (i) all parametric models explored provided a suboptimal visual fit to the KM data with the exponential and lognormal

distribution having the lowest AIC and BIC; (ii) all models apart from the exponential led to a plateau which would likely to be optimistic due to the nature of the disease.

Figure 13: Survival extrapolation included in company's base case analysis, PFS HGG for D+T for the prior TMZ and no prior TMZ subgroups, as per investigator assessment (reproduced from CS Figure 24)

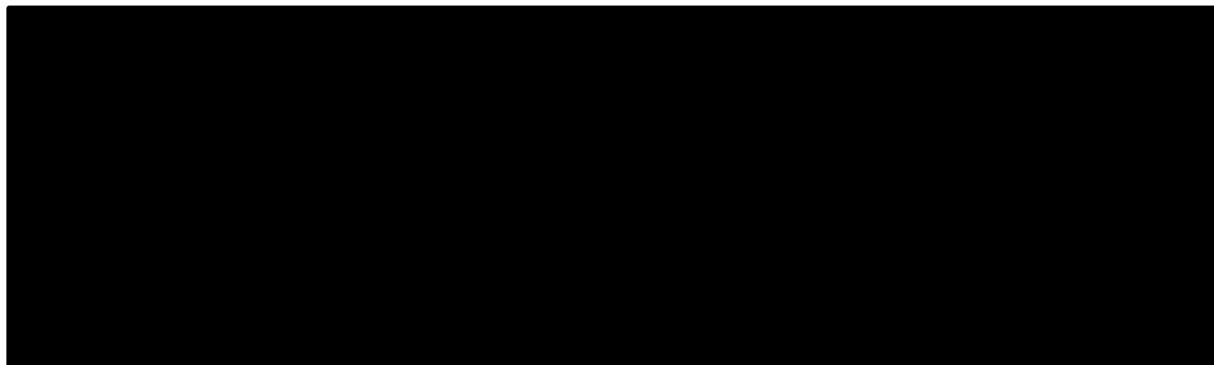

Source: Analysis of the TADPOLE trial

Abbreviations: D, dabrafenib; exp, exponential; HGG: high-grade glioma; KM, Kaplan-Meier; PFS, progression-free survival; T, trametinib; TMZ, temozolomide.

In response to clarification question B2 and B4,¹⁶ the company performed alternative extrapolation approaches (independently fitting parametric models to the prior TMZ and no prior TMZ subgroups for the independent review assessed PFS, with and without IPTW adjustment). This is discussed in detail in Section 4.3.3.1 of the EAG's critique, with the EAG's preferred approach to modelling PFS described in Section 4.5.2.

Glioma related deaths were estimated by calculating the time to progression or death (from the PFS curve). There was [REDACTED] of death upon the time to progression or death. The [REDACTED] was sourced from the TADPOLE HGG prospective cohort study.

For patients in the comparator arm, if they had no prior TMZ, an IPTW-adjusted HR ([REDACTED]) estimated from ITC was applied to the KM and to the exponential curve. If the patients had received prior TMZ, it was assumed that they had a time of 0 for PFS, so effectively they start the model in a progressed disease health state and the only event that happens to these patients is death.

4.2.5.2.3 Time to other deaths

4.2.5.2.3.1 Time to all-cause death

Time to all-cause death was estimated using the same Gompertz distribution fitted to ONS data on deaths in England and Wales 2018-2020. Full details are given in Section 4.2.5.1.6.1.

4.2.5.2.3.2 Glioma related death – pre-progression

Apart from the [REDACTED] of PFS events that were deaths (see Section 4.2.5.1.7), there was no further adjustment for glioma related deaths pre-progression in the company's HGG model.

4.2.5.2.3.3 Glioma-related death – progressed

The time to glioma related deaths for patients who have progressed disease were estimated using an analysis of the post progression survival (PPS) data (assessed by investigator) from the TADPOLE HGG prospective cohort study. The company fitted the same range of parametric models as for the extrapolation of PFS data. The same time to event was sampled in both arms of the HGG model analyses. This is the same analysis that is used in the LGG model, for patients with progressed malignant transformation. Full details of parametric model selection and diagnostics are given in Section 4.2.5.1.8.

4.2.5.2.4 Time to treatment discontinuation

Patients were assumed to discontinue their D+T at the earliest of progression or death (PFS), at 12.5 years or upon independent treatment discontinuation. The time to progression or death is described in Section 4.2.5.2.2.

The assumption of discontinuation of D+T at 12.5 years was included in the model, on the basis of the company's clinical expert's opinion that treatment would be unlikely to be stopped, but a small fraction of patients may stop treatment.(CS², page 115) This is implemented in the company's economic model as a stopping rule in which treatment will stop after 12.5 years.

The time to discontinuation for other reasons was taken from data collected from the D+T arm of the TADPOLE HGG cohort. To time to discontinuation for other reasons, the company fitted the same range of parametric models as for the extrapolation of PFS data. Figure 14 presents the fitted parametric model and goodness-of-fit statistics are presented in CS Appendix P. The company chose the exponential distribution for their base case analysis, because (i) it provides the best statistical fit with the lowest AIC and BIC; (ii) a constant rate can be deemed more realistic considering the small number of events. Alternative models (Gompertz, lognormal and log-logistic) were explored in scenario analysis and had a minor impact on the ICER.

Figure 14: Survival extrapolation, TTD HGG for D+T (reproduced from CS Appendix P)

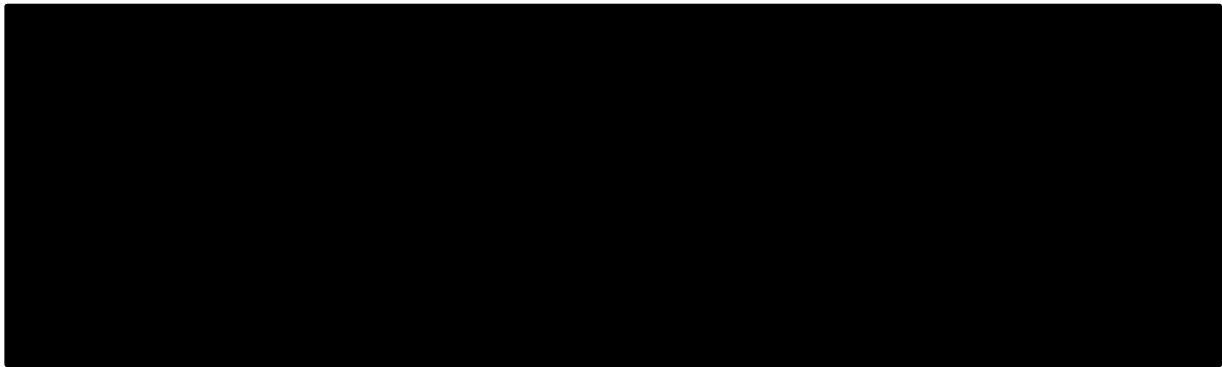

Abbreviations: exp, exponential; gomp, Gompertz; genGamma, generalised gamma; KM, Kaplan-Meier; llog, log-logistic; lnorm, lognormal; weib, Weibull.

4.2.5.2.5 Health state utility values

The company's model uses utility decrements. A full description of the rationale for this and the EAG's beliefs on this approach are given in Section 4.2.5.1.10.

The utility values used in the HGG model are summarised in Table 37. Full details and descriptions of the sources are given in Sections 4.2.5.2.5.1 to 4.2.5.2.5.3.

Table 37: A summary of utility values used in the HGG population

Health State	Mean	Standard error	Sources
Age – gender population norms	See supplementary Excel file in Hernandez Alava <i>et al.</i> ¹	Assumed no uncertainty	Hernandez Alava <i>et al.</i> ¹
Utility decrements compared to age-gender norms			
HGG pre progression	-0.155	*0.0155	Vera <i>et al.</i> ⁵⁸ & Janssen <i>et al.</i> ⁵⁹
Weekly reduction in utility when having progressed disease			
Weekly reduction in utility	1.1%	0.11%*	Drewes <i>et al.</i> ⁵⁷ & Calculation

* Standard error was assumed to be the absolute value of 10% of the mean HGG, high grade glioma

4.2.5.2.5.1 Age gender population norms

The age and gender population norms for utility in patients is the same as in the LGG model. Details are given in Section 4.2.5.1.10.1

4.2.5.2.5.2 No progression

A utility decrement was calculated using the utility of age-gender norms for a population subtracting the utility of patients with progressed Glioma.

The utility of patients in the no progression health state was obtained from Vera *et al.*⁵⁸ Vera *et al.* was a retrospective cohort study of 336 patients with malignant glioma in the US.⁵⁸ the EQ-5D-3L was collected and valued using the US value set.^{62, 64} Patients with progressed malignant glioma (matching the cohort in this analysis, as HGG patients in this appraisal have to have failed one line of systemic therapy see Section 2.2.1), had a mean utility of 0.70. In the overall cohort, the median age was 52 years old and then population was 64% male, albeit the characteristics of the population who had valid utilities are unknown.⁵⁸

The company assumed an age gender norm of utility for these patients of 0.855, which was taken by matching the median age in Vera *et al.* (52 years old) to the results of Janssen *et al.*^{58, 59} Janssen *et al.* was a study of age norms in 11 countries, using multiple cross sectional surveys in different countries.⁵⁹ Janssen used the EQ-5D-3L and used the US value set to derive age-gender norms in utility.^{62, 64} The decrement from these two sources was calculated as 0.855-0.7, which equals 0.155.

Vera *et al.* did not present any information on the uncertainty in the mean utility for patients with progressed malignant glioma, and Janssen *et al.* reported no uncertainty information, so the company assumed at standard error of 10% of the mean in the probabilistic analyses (Clarification Response,¹⁶ Question B16).^{57, 59}

4.2.5.2.5.3 Post-progression

Post progression, the company applied a constant reduction in HRQoL. It based this estimate using a study by Drewes *et al.*⁵⁷ Drewes *et al.* was a prospective cohort study of 136 adult (age ≥ 18) patients treated with surgery for their glioma in one hospital in Norway.⁵⁷ Drewes *et al.* collected EQ-5D-3L scores and turned the patient responses to the EQ-5D-3L into utility scores using the UK value set.⁶² Drewes *et al.* reported the median utilities in the HGG population at baseline, 1-month post-surgery and 6 months post-surgery. Drewes reported a median baseline utility of 0.76, a median 1-month post-surgery utility of 0.76 and a median 6-month post-surgery utility of 0.38.

Importantly when considering the appropriateness of the analysis conducted by the company, in the analysis conducted by Drewes *et al.*⁵⁷ it is stated “the EQ-5D index values for the HGG group at 6 months were influenced by our choice to include patients who died during follow-up and rate their (missing) EQ-5D index value as “zero.”” (Drewes *et al.*⁵⁷, ppE469) Given this, the company assumed that the utility of patients alive and progressed would be 0.57, rather than the reported 0.38.² They calculated that this resulted in a 1.1% reduction per week in utility for people with progressed HGG in the model. The EAG notes that Drewes *et al.*⁵⁷ reported a post hoc analysis of survivors at 6 months in the HGG cohort and reported a median utility for these patients of 0.7.⁵⁷

4.2.5.2.6 Resource use

4.2.5.2.6.1 Adverse events

The grade 3/4 AEs incidence rates associated with D+T were obtained from the TADPOLE LGG RCT and the TADPOLE HGG prospective cohort study as reported in the CS and those associated with TMZ were obtained from Verschuur *et al.*^{2, 38, 45} Verschuur *et al.* investigated the use of TMZ in paediatric HGG in a cohort of 15 UK patients with recurrent (recurrence or progression after neurosurgery, radiotherapy, chemotherapy, with prior chemotherapy within the last 4 weeks leading to exclusion) high-grade glioma whose mean age at TMZ initiation was 12.0 years. These data are reported in

Table 38.

Table 38: HGG adverse effect incidence rates associated with treatment (modified from Table 44 in the CS²)

Adverse event	Incidence	
	D+T	TMZ
Neutrophil count decreased	████	0.0%
Alanine aminotransferase increased	████	0.0%
Platelet count decreased	████	0.0%
Blood creatine phosphokinase increased	████	0.0%
Aspartate aminotransferase increased	████	0.0%
Ejection fraction decreased	████	0.0%
Amylase increased	████	0.0%
Lipase increased	████	0.0%
Pancreatitis	████	0.0%
Hypersensitivity	████	0.0%
Viral infection	████	0.0%
Rash	████	0.0%
Hypertension	████	0.0%
Hypotension	████	0.0%
Pyrexia	████	0.0%
Gastrointestinal Haemorrhage	████	0.0%
Diarrhoea	████	0.0%
Agitation	████	0.0%
Confusional state	████	0.0%
Uterine haemorrhage	████	0.0%
Neutropenia	████	40.0%
Thrombocytopenia	████	40.0%
Weight increased	████	0.0%
Uveitis	████	0.0%
Influenza like illness	████	0.0%
Brain oedema	████	0.0%

D & T: dabrafenib & trametinib; TMZ: temozolomide

4.2.5.2.6.2 Disutility associated with adverse events

The CS assumes that disutility values associated with grade 3/4 AEs are associated with a disutility of 0.075 applicable over a period of 7 days, based on a regression analysis conducted as part of TA772.²

⁶¹ The CS assumes that adverse events associated with TMZ were likely to have been captured in the TADPOLE HGG prospective cohort study, therefore the occurrence of AEs were multiplied by the TA772 decrement to give a one off utility decrement applied at the start of the model. This gives a QALY decrement of 0.00115.

4.2.5.2.7 Unit costs

The model includes the following cost components: (i) costs associated with drug acquisition; (ii) costs associated with drug administration; (iii) costs associated with the disease progression; (iv) costs associated with the management of AEs; and (v) costs associated with end-of-life care. A summary of the model cost parameters and their derivation is shown below.

4.2.5.2.7.1 Intervention costs and dosing

The intervention costs are given in Section 4.2.5.1.12.2. The intervention dosing was taken from a regression analysis of the TADPOLE HGG prospective cohort study. This is given in Table 39.

Table 39: The regression formulae used to predict the dose of intervention (in mg) treatments in the company’s economic model for high grade glioma patients receiving Dabrafenib and Trametinib

	Mean	Distribution	Covariance	Source
Dabrafenib				
Constant	████	Multivariate Normal	████ ██████████ ██████████	CS ² , company’s model
Gender (1 = male, 0 =female)	████		████████ ██████████ ██████████ ████████ ██████████ ██████████	
Ln(Age in years)	████			
Trametinib				
Constant	████	Multivariate Normal	████ ██████████ ██████████	CS ² , company’s model
Gender (1 = male, 0 =female)	████		████████ ██████████ ██████████ ████████ ██████████ ██████████	
Ln(Age in years)	████			

4.2.5.2.7.2 Comparator costs

The only comparator treatment available to HGG for non-progressed patients is TMZ, in the case of TMZ naivety. If patients have previously progressed on TMZ then they will receive BSC in line with all patients in the post-progression health state. The dosage of TMZ is presented in Table 40; the cost of TMZ is given in Table 41.

Table 40: Dosage for the comparator treatments

Drug regimen	Drug	Dose
TMZ	Temozolomide	200 mg/m ² orally once daily until progression

TMZ: temozolomide; mg/m²: milligram per square meter

Table 41: List and NHS prices for the comparator treatments

Treatment	Dose per unit	Formulation	Pack size	List price	NHS price	Source
TMZ	100 mg	Capsule	5	£45.51	£38.53	eMIT ⁶⁵

TMZ: temozolomide; mg: milligram; eMIT: electronic market information tool.

4.2.5.2.7.3 Drug administration

As dabrafenib, trametinib and temozolomide are all oral treatments there are no costs associated with drug administration.

4.2.5.2.7.4 Costs associated with disease progression

According to the CS, the palliative care received by paediatric HGG patients is varied and multi-disciplinary and associated with a four-week cost of £1,100 based on the assumptions that patients require one outpatient visit, one non-medical specialist palliative care visit (which is assumed to encompass referrals to allied services) and two specialist nurse visits in every four-week period.² The company's clinical experts noted that there is considerable variation in resource use with some patients requiring more regular visits while other patients requiring fewer visits. The breakdown for the costs used in the CS is replicated in Table 42.

Table 42: Breakdown of the four weekly palliative care cost for paediatric HGG patients modified from Table 51 in the CS²)

Description	Detailed description	Cost	Source
Multi-professional visit	Consultant led outpatient visit WF02A, oncology, multi-professional, face-to-face, follow up, not admitted.	£372.30	NHS Ref Costs ⁶⁸
Non-medical specialist palliative care visit	Non-medical specialist palliative care attendance SD05B, 18 years and under.	£594.21	
Nurse specialist	Specialist cancer related nursing N10CF, child, face-to-face.	£66.66	

4.2.5.4.7.5 Adverse event costs

For HGG patients receiving TMZ, the costs associated with grade 3/4 AEs were incorporated at model entry as most AEs had been captured within the study period. The frequency of each adverse event category was multiplied by the unit cost to give one-off cumulative adverse events costs of £4,519.

For patients receiving D+T, treatment duration went beyond that observed in the study period and consequently had to be extrapolated while adjusting for exposure and applied in the model at a value of £1,486 per year of treatment.

The costs associated with adverse events is presented below in Table 43.

Table 43: Costs associated with adverse events (modified from CS², Table 52)

Adverse event	Detailed description	Cost	Source
Neutrophil count decreased	PG71A: Paediatric hepatobiliary or pancreatic disorders	£3,062	NHS Ref Costs ⁶⁸
White blood cell count decreased			
Alanine aminotransferase increased			
Lymphocyte count decreased			
Platelet count decreased			
Blood creatine phosphokinase increased			
Gamma-glutamyltransferase			
Hypomagnesaemia			
Aspartate aminotransferase increased			
Ejection fraction decreased			
Amylase increased			
Lipase increased			
Pancreatitis			
Hypersensitivity	PW01A: Paediatric minor infections	£1,476	
Abdominal infection			
Device related infection			
Infusion related reaction			
Viral infection	PJ66A: Paediatric, rash or other non-specific skin eruption	£704	
Rash			
Urticaria			
Flushing	EB04Z Hypertension	£770	
Hypertension			
Hypotension	PR04A Paediatric, headaches or migraines	£1,116	
Headache			
Dizziness			
Pyrexia	PF26A Paediatric other gastrointestinal disorders	£1,542	
Gastrointestinal Haemorrhage			
Diarrhoea	PT52A Paediatric behavioural disorders	£2,200	
Agitation			
Confusional state			
Peripheral motor neuropathy	PX29A Paediatric abdominal pain	£861	
Peripheral sensory neuropathy			
Uterine haemorrhage			

Adverse event	Detailed description	Cost	Source
Anaemia	SA03G Haemolytic anaemia	£1,519	
Neutropenia	PM45A Paediatric febrile neutropenia with malignancy	£10,303	
Thrombocytopenia	SA12G Thrombocytopenia	£993	
Weight increased	PK72A Paediatric metabolic disorders	£740	
Uveitis	PP64A Paediatric non-surgical ophthalmology	£1,375	
Vomiting	PF28A Paediatric feeding difficulties or vomiting	£1,480	
Influenza like illness	PW20A Paediatric fever of unknown origin	£1,431	
Brain oedema	PC63A Paediatric head neck or ear disorders	£978	

4.2.6 Model validation and face validity check

The EAG validated the company's model parameters corresponded to the original CS and checked the VBA code and Excel calculations for annual costs submitted by the company. The EAG had one key concern, and this was the implementation of how the company had done the sampling of the time to events. Ultimately, the EAG believes that there is unlikely to be anything other than minor implementation errors that are unlikely to effect the results. Full details are given below.

The VBA code involves manual implementation of code to generate the sampled time to events in the model. The functions that did this did deviate from standard texts used for these formulae, such as Law *et al.*, they included a hazard ratio that could be applied to the parametric function, and they calculated a hazard directly based on these functions. Secondly, the function 'generate time', was unclear in its purpose as it was not commented and appeared to be an attempt to adjust for a period on the Kaplan-Meier curve followed by a fitted parametric model. Again, the formulae to do this is not available in standard texts such as Law *et al.*⁷¹ The EAG was unclear why the code is implemented the way it is and whether it is fulfilling this design purpose.

Therefore the EAG asked the company clarification question B1, which was “*Please clarify, for all functions in the Generate_TTE module, what sources have you used to determine the mathematical formulae applied and what validation of these VBA functions were conducted*”.¹⁶ The company established that the source for the time to event functions was the flexsurv package in R. The EAG could not find in the package documentation any mathematical form for adding a hazard ratio when sampling from a time to event or sampling from a KM followed by a parametric extrapolation or for initially extrapolating from a KM followed by a parametric model. However, the company’s validations showed that for all parametric models, that the sampled the time to event predictions from 2,000 patients showed a good fit to the survivor functions that would be fitted in a cohort model. However, there was no validation of the piecewise KM followed by a parametric function with a hazard ratio.

The EAG conducted additional validation of this in the company’s base case analysis for the D+T arm of their model. The results of the EAG’s additional validation are given in

Figure 15. The EAG considers that this validation shows that the time to event model predicts the known survivor function very well, with the small difference there are likely to be due to random number variation. The EAG believes that if there are any errors in the company's implementation of the time to event functions, they are likely to be small and are unlikely to affect the results of its base case economic analyses meaningfully.

Figure 15: Comparison of the time to event functions for progression free survival in low grade glioma patients receiving dabrafenib and trametinib to survivor functions, with both the time to event functions and the survivor functions using a piecewise Kaplan-Meier function followed by a log normal parametric extrapolation.

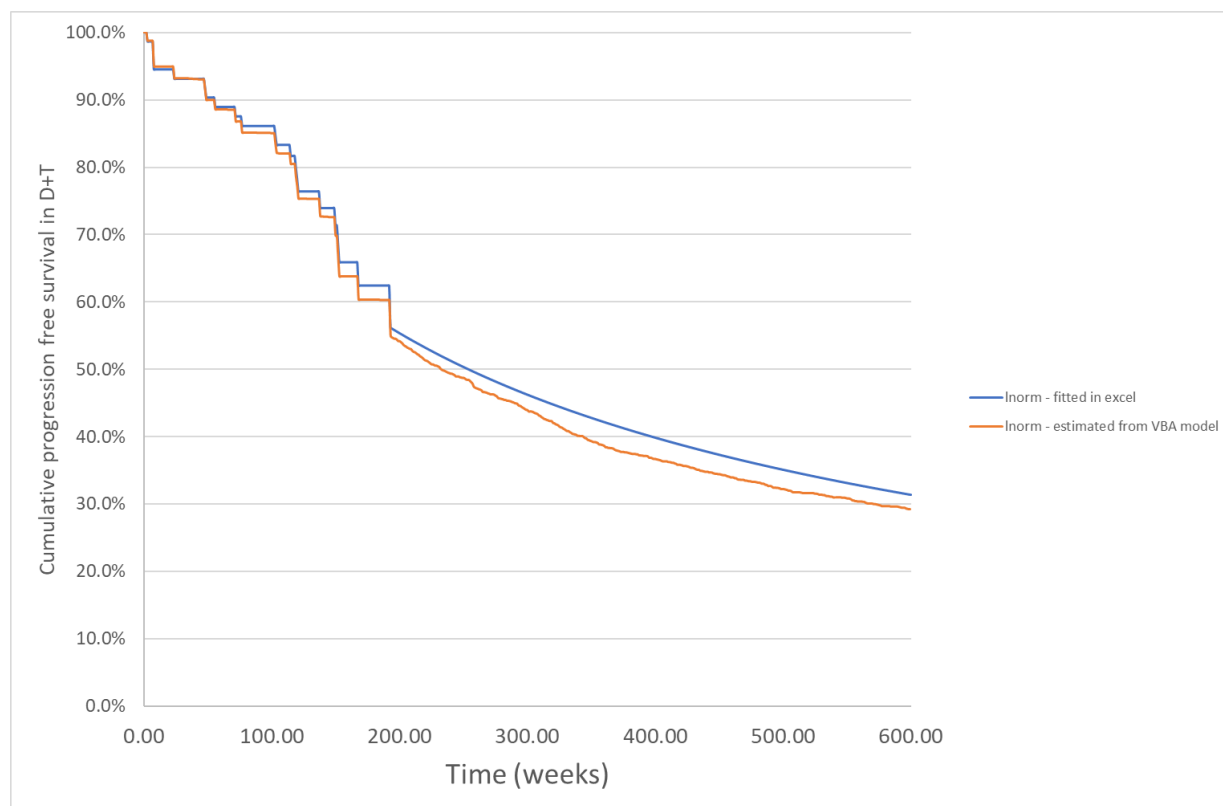

4.2.7 Cost-effectiveness results: base case

The EAG has based this section on the company’s model submitted in their response to the EAG’s additional clarification question. This model includes the company addressing an error in the estimation of the Kaplan-Meier curves, and includes updated values for AE costs (Clarification Response¹⁶, Question B10), treatment costs for comparators (Clarification Response¹⁶, Question C6) and includes uncertainty in the KM curves in the probabilistic analyses (Clarification Response¹⁶, Question B9). The results in this section are based EAG reruns of the company’s model conducted on the 8th December 2023. The EAG modified this model slightly so that (i) general population utilities were recorded from the PSA; (ii) the disease severity modification was done based on the mean general population utility, and mean utility in the comparator arm rather than being done based on the results of each PSA run; and (iii) added sufficient columns and calculations to the RunAllSA worksheet to conduct the economic analysis.

4.2.7.1 LGG

Table 44 shows the results of the EAG’s rerun of the company’s submitted analyses, in which the EAG also conducted 1,000 PSA iterations. The EAGs results are very similar to the company’s analyses in

the CS.² The ICER before applying modification for disease severity is £30,701 in the probabilistic model and £30,931 in the deterministic model. There is a case for applying a disease severity modifier in this analysis, as the absolute (discounted) QALY shortfall is 12.74 and the proportional shortfall is 52.8%. Therefore, according to the methods guide a disease severity modifier of 1.2 should be applied to the QALYs. After applying the disease severity modification, the ICER is £25,584 in the probabilistic model and £25,776 in the deterministic model. 95% confidence intervals were calculated around the ICER using the Hatswell *et al.* method, we found that the 95% CI was (£25,433, £25,736). The EAG believes that sufficient PSA iterations have been conducted. The cost-effectiveness plane and cost-effectiveness acceptability curve after the application of the disease severity modifier are given in Figure 16 and Figure 17. Given these results, the EAG believe that the model is deterministic, so all subsequent EAG analyses were conducted with the deterministic model.

Table 44: The company’s discounted base case model results in the LGG cohort

Treatment	Total QALYs	Total Costs	ICER (£ per QALY gained)	Probability that D+T provides the most net benefit		Expected QALYs in the General population	QALY Shortfall (Absolute / proportional)
				£20,000 per QALY gained	£30,000 per QALY gained		
Probabilistic							
Current Practice	11.38	£87,069	-	-	-	24.12	12.74 / 52.8%
D+T	████	████	-	-	-	-	-
Incremental	████	████	£30,701	████	████	-	-
Incremental, 1.2 severity modifier	████	████	£25,584	████	████		
Deterministic							
Current Practice	11.39	£88,416	-	-	-	24.12	12.73 / 52.8%
D+T	████	████	-	-	-	-	-
Incremental	████	████	£30,931	-	-	-	-
Incremental, 1.2 severity modifier	████	████	£25,776				

QALYs, quality adjusted life years; ICER, incremental cost-effectiveness ratio, D+T, dabrafenib and trametinib

Figure 16: The cost-effectiveness acceptability curve in the LGG population, after applying a disease severity modifier of 1.2

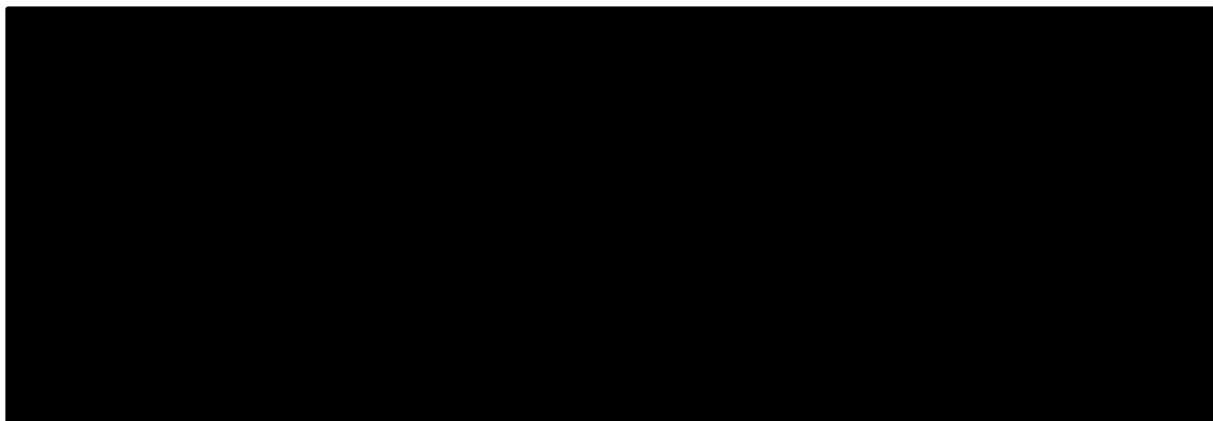
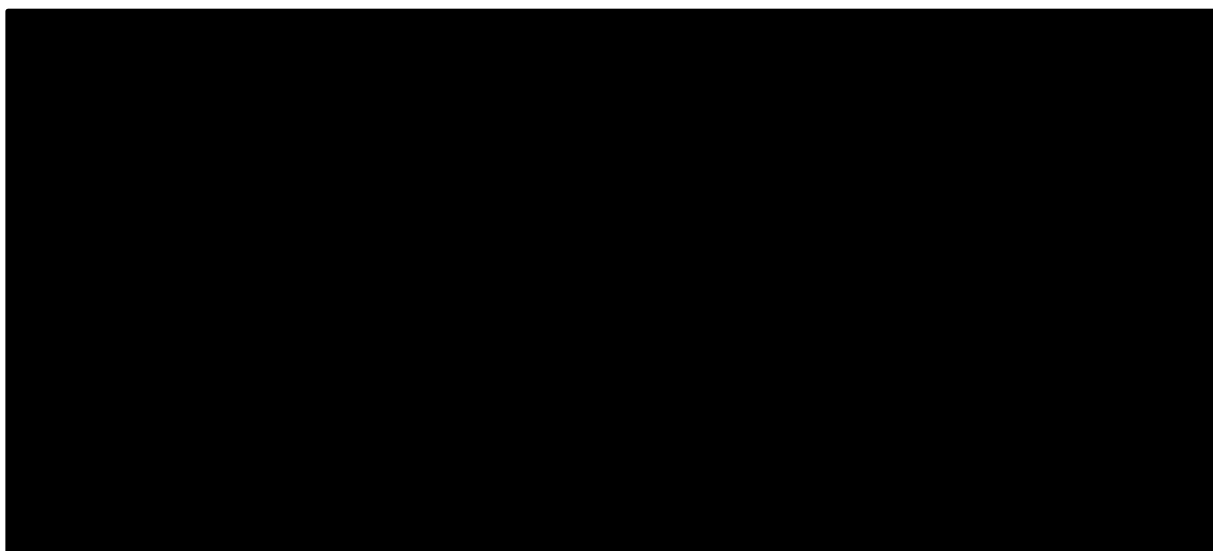

Figure 17: The cost-effectiveness acceptability curve in the LGG population, after applying a disease severity modifier of 1.2



4.2.7.2 HGG (no prior TMZ subgroup)

Table 45 shows the results of the EAG's rerun of the company's submitted analyses, in which the EAG also conducted 1,000 PSA iterations. The EAGs results are very similar to the company's analyses in the CS.² The ICER before applying modification for disease severity is £48,096 in the probabilistic model and £46,750 in the deterministic model. There is a case for applying a disease severity modifier in this analysis, as the absolute (discounted) QALY shortfall is 22.99 and the proportional shortfall is 96.5% in the probabilistic model (with similar results in the deterministic model). Therefore, according to the methods guide a disease severity modifier of 1.7 should be applied to the QALYs.⁵⁶ After applying the disease severity modification, the ICER is £28,292 in the probabilistic model and £27,500 in the deterministic model. 95% confidence intervals were calculated around the ICER using the

Hatswell *et al.* method, we found that the 95% CI was (£28,214, £28,370).⁷² The EAG believes that sufficient PSA iterations have been conducted. The cost-effectiveness plane and cost-effectiveness acceptability curve after the application of the disease severity modifier are given in Figure 18 and Figure 19. Given these results, the EAG believe that the model is deterministic, so all subsequent EAG analyses were conducted with the deterministic model.

Table 45: The company’s discounted base case model results in the HGG cohort, TMZ naïve subgroup

Treatment	Total QALYs	Total Costs	ICER (£ per QALY gained)	Probability that D+T provides the most net benefit		Expected QALYs in the General population	QALY Shortfall (Absolute / proportional)
				£20,000 per QALY gained	£30,000 per QALY gained		
Probabilistic							
Current Practice	0.83	£27,869	-	-	-	23.82	22.99 / 96.5%
D+T	■	■	-	-	-	-	-
Incremental	■	■	£48,096	■	■	-	-
Incremental, 1.7 severity modifier	■	■	£28,292	■	■		
Deterministic							
Current Practice	0.73	£27,256	-	-	-	23.81	23.08 / 96.9%
D+T	■	■	-	-	-	-	-
Incremental	■	■	£46,750	-	-	-	-
Incremental, 1.7 severity modifier	■	■	£27,500				

QALYs, quality adjusted life years; ICER, incremental cost-effectiveness ratio, D+T, dabrafenib and trametinib

Figure 18: The cost-effectiveness plane in the HGG population who are TMZ naïve, after applying a disease severity modifier of 1.7

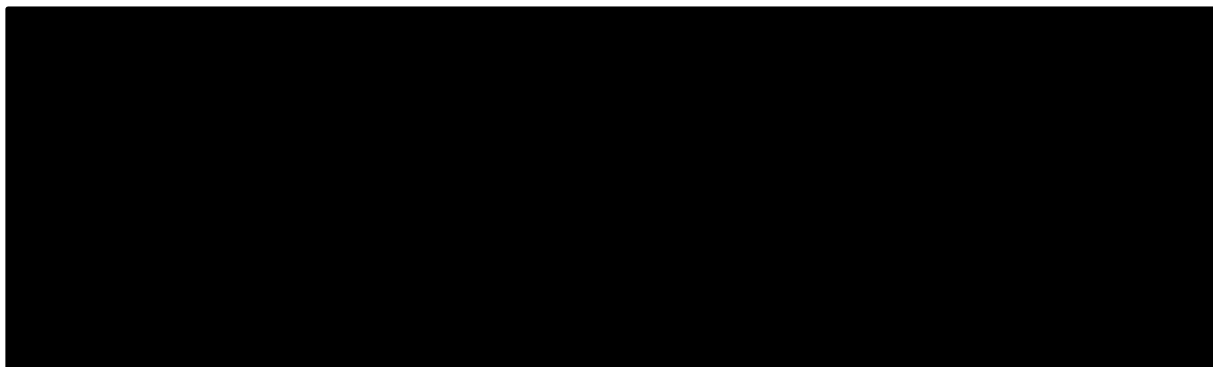
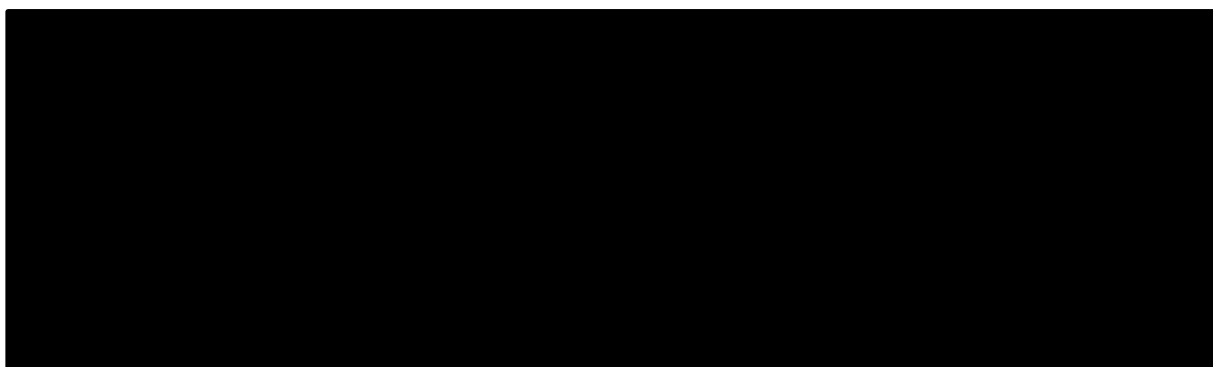

Figure 19: The cost-effectiveness acceptability curve in the HGG population who are TMZ naïve, after applying a disease severity modifier of 1.7



4.2.7.3 HGG (prior TMZ subgroup)

Table 46 shows the results of the EAG's rerun of the company's submitted analyses, in which the EAG also conducted 1,000 PSA iterations. The EAGs results are very similar to the company's analyses in the CS.² The ICER before applying modification for disease severity is £47,486 in the probabilistic model and £49,665 in the deterministic model. There is a case for applying a disease severity modifier in this analysis, as the absolute (discounted) QALY shortfall is 23.58 and the proportional shortfall is 98.8% in the probabilistic model (with similar results in the deterministic model). Therefore, according to the methods guide a disease severity modifier of 1.7 should be applied to the QALYs.⁵⁶ After applying the disease severity modification, the ICER is £27,933 in the probabilistic model and £29,214 in the deterministic model. 95% confidence intervals were calculated around the ICER using the Hatswell *et al.* method, we found that the 95% CI was (£27,783, £28,084).⁷² The EAG believes that sufficient PSA iterations have been conducted. The cost-effectiveness plan and cost-effectiveness acceptability curve after the application of the disease severity modifier are given in Figure 20 and

Confidential until published

Figure 21. Given these results, the EAG believe that the model is deterministic, so all subsequent EAG analyses were conducted with the deterministic model.

Table 46: The company’s discounted base case model results in the HGG cohort, TMZ experienced subgroup

Treatment	Total QALYs	Total Costs	ICER (£ per QALY gained)	Probability that D+T provides the most net benefit		Expected QALYs in the General population	QALY Shortfall (Absolute / proportional)
				£20,000 per QALY gained	£30,000 per QALY gained		
Probabilistic							
Current Practice	0.29	£15,532	-	-	-	23.82	23.52 / 98.8%
D+T	■	■	-	-	-	-	-
Incremental	■	■	£47,486	■	■	-	-
Incremental, severity modifier 1.7	■	■	£27,933	■	■	-	-
Deterministic							
Current Practice	0.45	£20,873	-	-	-	23.81	23.36 / 98.1%
D+T	■	■	-	-	-	-	-
Incremental	■	■	£49,665	-	-	-	-
Incremental, severity modifier 1.7	■	■	£29,214			-	-

QALYs, quality adjusted life years; ICER, incremental cost-effectiveness ratio, D+T, dabrafenib and trametinib

Figure 20: The cost-effectiveness plane in the HGG population who are TMZ experienced, after applying a disease severity modifier of 1.7

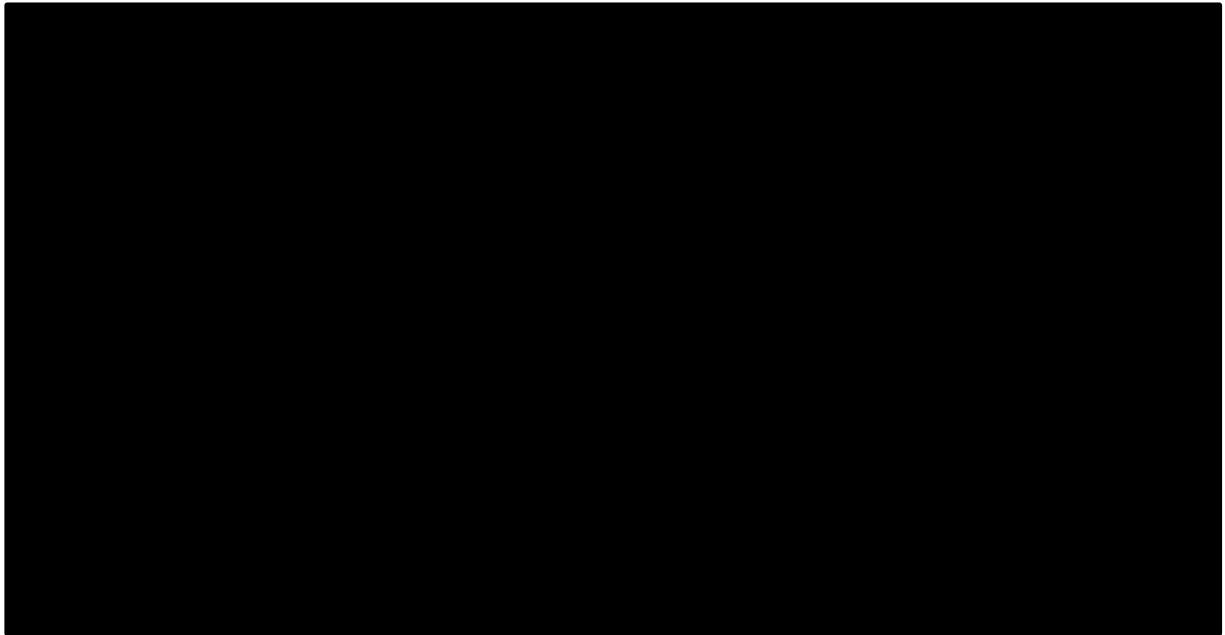
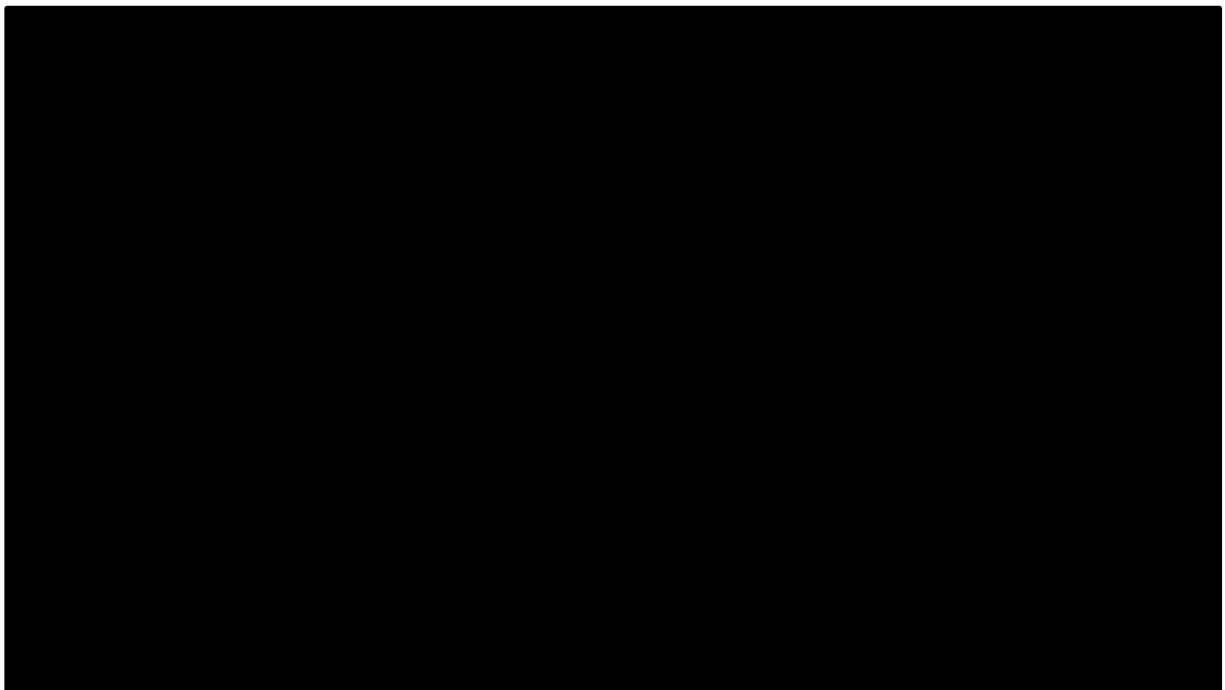

Figure 21: The cost-effectiveness acceptability curve in the HGG population who are TMZ experienced, after applying a disease severity modifier of 1.7



4.2.8.1.2 Scenario analyses

The company conducted scenario analyses around several parameters in the model. Full details are provided in Appendix Q of the CS.² The scenarios that the company chose to present are in Figure 23. The ICER was most sensitive to the treatment duration and the PFS definition.

Figure 23: The scenarios selected by the company to present in a tornado plot (replicated from CS, Figure 38, page 152).

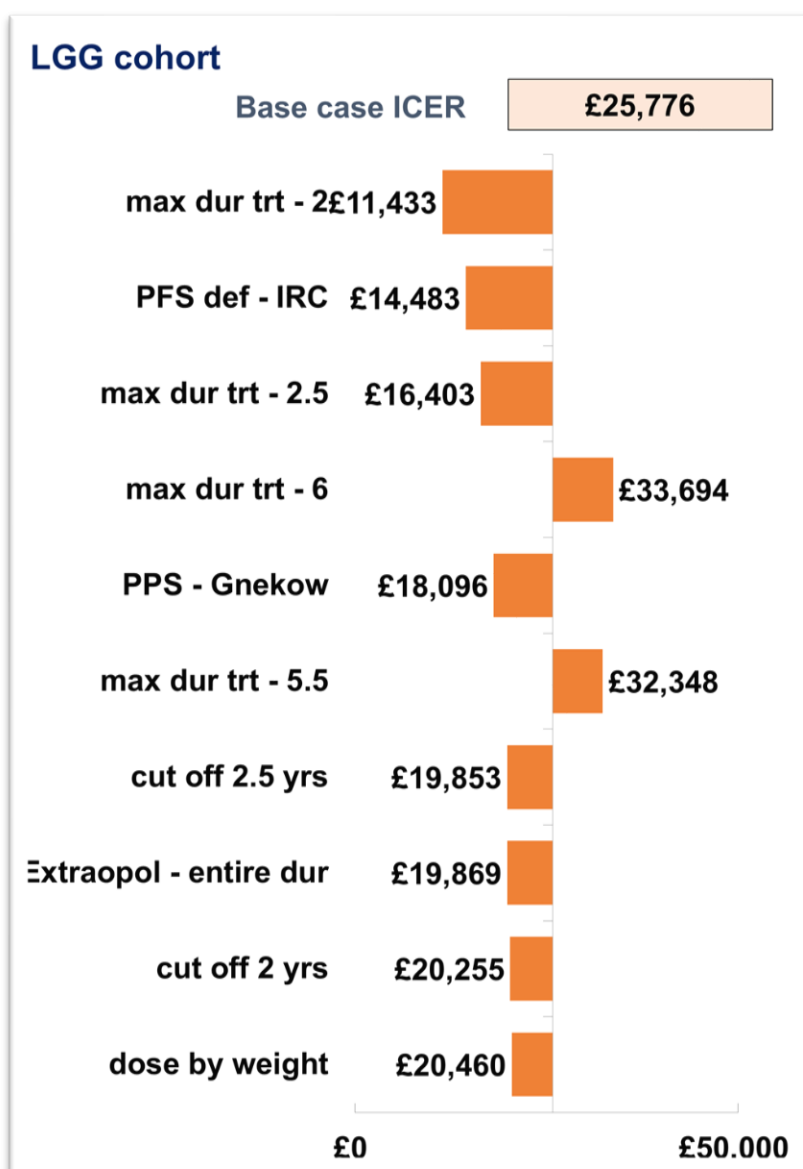

4.2.8.2 HGG (no prior TMZ subgroup)

4.2.8.2.1 Deterministic sensitivity analyses

The tornado plot of the sensitivity of the HGG model for the no prior TMZ subgroup is given in Figure 24. In terms of sensitivity to parameter uncertainty, the ICER is reasonably insensitive to the parameter uncertainty in the company's model.

Figure 24: The tornado plot showing how sensitive the company’s model is to the changes in some key parameters using a disease severity modifier of 1.2 (replicated from CS², Figure 38, page 152)

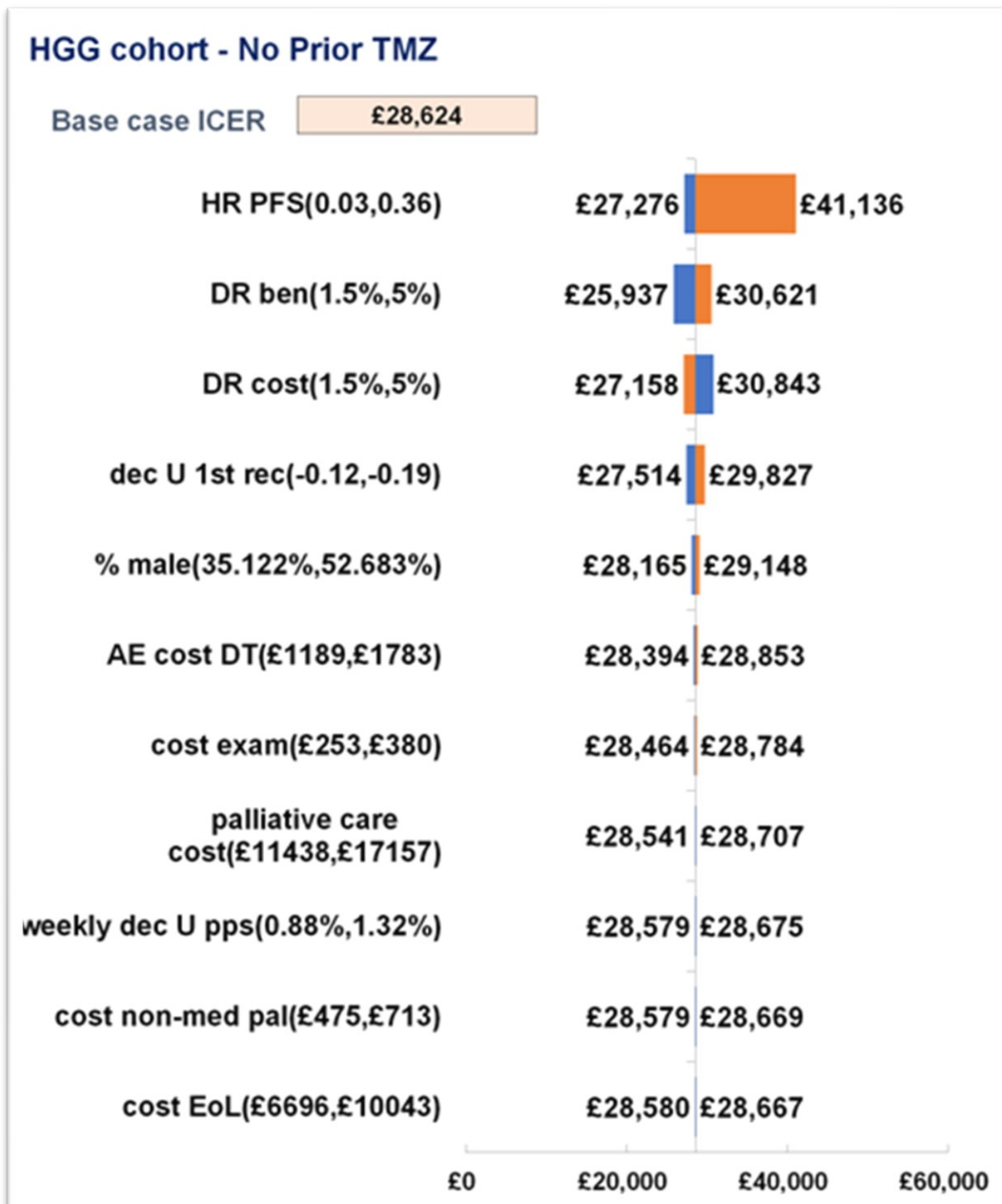

4.2.8.2.2 Scenario analyses

The company conducted scenario analyses around several parameters in the model. Full details are provided in Appendix Q of the CS.² The scenarios that the company chose to present are in Figure 25. The ICER was most sensitive to the parametric extrapolation model for PFS and the treatment duration.

Figure 25: The scenarios selected by the company to present in a tornado plot (replicated from CS, Figure 39, page 153).

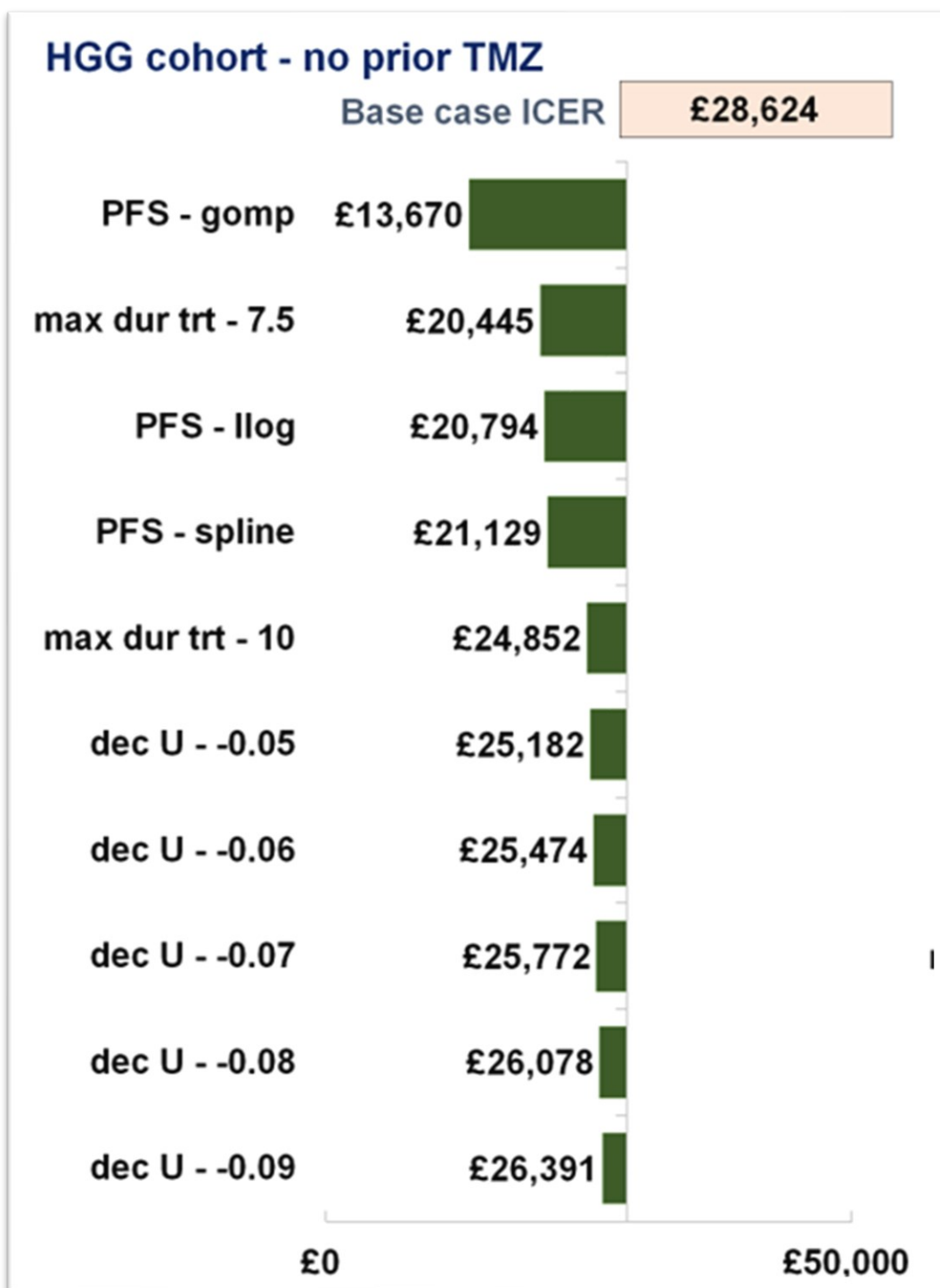

4.2.8.3 HGG (prior TMZ subgroup)

4.2.8.3.1 Deterministic sensitivity analyses

The tornado plot of the sensitivity of the HGG model in the prior TMZ subgroup is given in Figure 26. In terms of sensitivity to parameter uncertainty, the ICER is reasonably insensitive to the parameter uncertainty in the company’s model.

Figure 26: The tornado plot showing how sensitive the company’s model is to the changes in some key parameters using a disease severity modifier of 1.2 (replicated from CS², Figure 38, page 152)

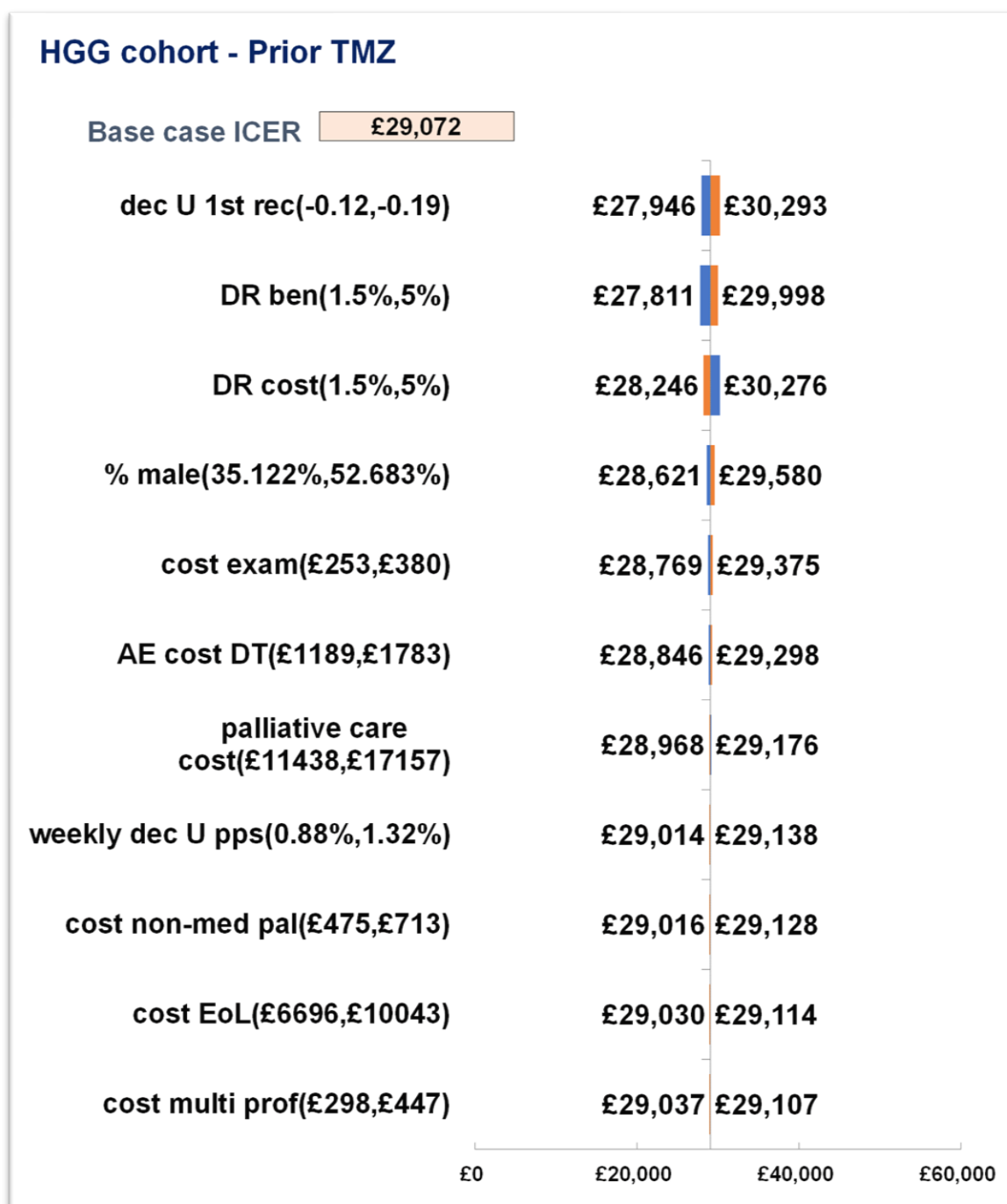

4.2.8.3.2 Scenario analyses

The company conducted scenario analyses around several parameters in the model. Full details are provided in Appendix Q of the CS.² The scenarios that the company chose to present are in Figure 27. The ICER was most sensitive to parametric model used to extrapolate PFS.

Figure 27: The scenarios selected by the company in their analyses in the HGG population who are TMZ experienced presented in a tornado plot (replicated from CS², Figure 39, page 153).

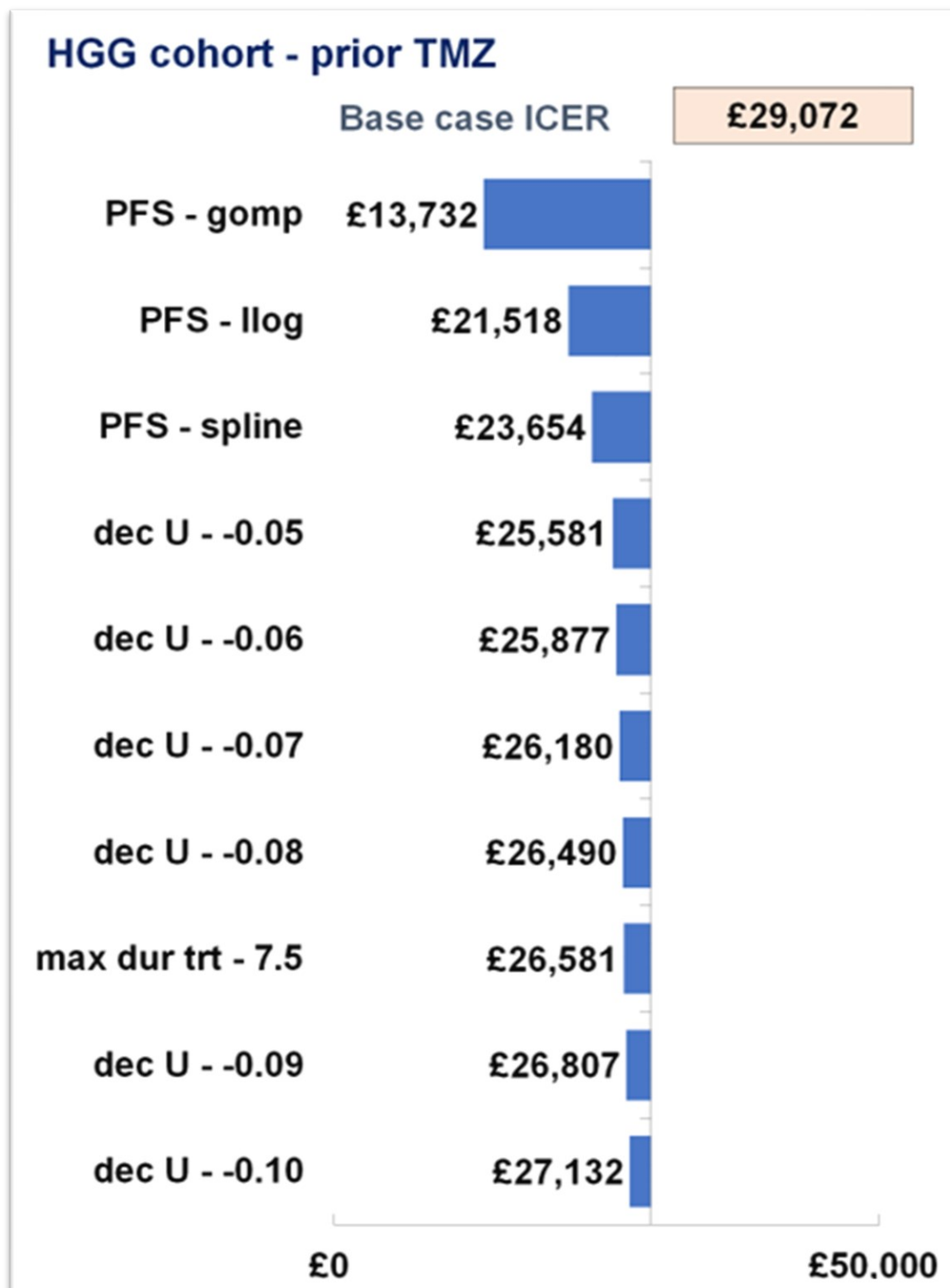

4.3 Critique of company's submitted economic evaluation by the EAG

4.3.1 *LGG and HGG*

4.3.1.1 *Wastage*

The EAG notes that there was no wastage in the company's submission for C+V, D+T or for any subsequent lines of chemotherapy. This was confirmed by the company's response to clarification question B13.¹⁶ Our clinical advisors stated that vial sharing of chemotherapies would be very rare, as glioma in children is very rare. The EAG believes that all comparator chemotherapies should be costed as though full vials are used.

Furthermore, the EAG notes that trametinib appears to be made from a powder into bottles for patients to administer (the draft SmPC for oral trametinib was not available to the EAG). This does raise the potential that there would be some small wastage of trametinib in real word practice that is not included in the company's model. However, unlike the chemotherapies in the control arm, this be from bottle breakage and spillage, rather than from complete bottles being discarded when a patient receives treatment. Therefore, the EAG believes that this effect would be relatively small compared to the wastage for treatments in the control arm.

4.3.1.2 *Duration of time on Dabrafenib + Trametinib*

The maximum time on D+T is assumed in the CS to be 3.71 years in the LGG cohort and 12.5 years in the HGG cohort based on expert opinion. This means that the costs are limited to this period. Whilst the same hazard is assumed in both arms after this, this is a relative benefit. If D+T were to be used for a longer time period in clinical practice it may accrue the ratio of costs accrued and benefits received may be different than during the time on treatment in the initial 3.71 years in the LGG cohort or 12.5 years in the HGG model. Our clinical advisors had mixed opinions on this, with one clinical advisor believing that treatment could continue indefinitely and the other believing that the company's base case was reasonable as treatment cessation would be considered at this point if the patient had not progressed, died or discontinued due to other adverse events.

4.3.1.3 *Utility values – the population*

All of the studies used to inform the utilities in the company's model were conducted in adults. The EAG believes that this is important to consider when interpreting the results of both the company's and the EAG's exploratory analyses. The EAG is not aware of any studies in children that have been missed. This does mean that the utility values are derived from populations of adults with glioma filling in instruments designed for completion by adults, with value sets for these instruments being derived from adults. The EAG attempted to gain advice from our clinical advisors on what the utility values in children may be, however their responses appeared to be anchored on the EAG's arbitrary examples, so we believe that is not meaningful or useful to use these values in a sensitivity analysis.

4.3.1.4 Utility values – HGG post-progression

The EAG notes the company missed that Drewes *et al.* reported the median utility (in line with all other utility values reported in this paper) of patients with progressed HGG who had not died in their discussion on page E469 as being 0.7.⁵⁷ The EAG also note, that this was very easy to miss, as it is not located in the results or methods sections of the paper. Updating the company’s analyses of the weekly utility decrement for progressed HGG with this value, rather than 1.1% in the company’s base case provides a weekly reduction in utility of 0.32%. Given that this is estimated from median rather than mean utility and that it is lower than the utilities reported in TA121, the EAG believes that the weekly decrement of 0.5% per week should be used for progressed HGG and that 0.32% should be used in a scenario analysis.⁷³

4.3.1.5 Implementation of all-cause mortality

The company has fitted Gompertz models to all-cause mortality from the ONS and applied a hazard ratio to adjust for age at model entry (see Section 4.2.5.1.6.1). It is unclear to the ERG how the company analysed the lifetable data to produce these estimates, as we believe that individual level data would be required to produce the company’s estimates.

A more traditional approach, and compatible approach to using summary data, would be to estimate the survivor functions for age-gender combination in the appraisal with an assumption that the patient’s death could randomly occur at any point within the year. However, as the Gompertz distribution the company has fitted has a good visual fit to the ONS data, the hazard ratio is very small, and the model results for life expectancy have face validity, the EAG does not believe that changing this would be meaningful in this case, as life expectancy is very long in children.

4.3.2 LGG only

4.3.2.1 Modelling of time to progression or death (PFS)

The EAG disagrees with the company’s survival extrapolation approach for PFS for the following reasons: (i) investigator assessed PFS is not used routinely in practice to determine progression; (ii) the hybrid extrapolation approach (KM followed by a parametric model for the tail) is highly arbitrary; and (iii) assuming the same rate of progression for both arms has not been justified by the company.

The company uses investigator determined progression from the TADPOLE LGG RCT in the base case and states that “*Clinical experts indicated that PFS as assessed by the investigator is a more accurate reflection of when a patient would be deemed to have progressive disease in clinical practice, and is a more accurate reflection of the decision for when to stop treatment.*” The EAG disagrees with the use of investigator assessed PFS for efficacy because the standard approach for determining progression in

clinical reviews is independent review, which was confirmed by the EAG's clinical advisors. The EAG believes that independent review determined PFS should be used to determine progression.

The EAG disagrees with the use of hybrid approach with KM data followed by a parametric model to extrapolate survival data for the C+V arm as this approach is highly arbitrary. Furthermore, the uncertainty associated with progression in the period when the KM is used was not propagated properly by the company in their original model. The EAG also disagrees with using the same rate of progression for the D+T and C+V arm beyond the observed KM as this assumption has not been justified by the company.

The EAG's preferred approach to model PFS for the D+T and C+V arm is to independently fit parametric models the PFS data based on the independent review assessed PFS. The details of model selection are described in Section 4.4.2.1.1 and Section 4.4.2.1.2.

4.3.2.2 Modelling of time to progressed malignant transformation

The EAG disagrees with the company's model choice of using the Weibull distribution to extrapolate time to progressed malignant transformation based on data from Jakacki *et al.* because the Weibull distribution does not fit the observed KM data. The details of the EAG model selection are described in Section 4.4.2.1.3.

4.3.2.3 Modelling of time to Glioma specific death (post-progression after malignant transformation)

The EAG disagrees with the use of investigator assessed PFS for efficacy because the standard approach for determining progression in clinical reviews is independent review, which was confirmed by the EAG's clinical advisors. The EAG believes that independent review determined PFS should be used to determine progression.

The EAG's preferred approach to model time to Glioma specific death (post-progression after malignant transformation) is to fit parametric models to the post-progression after malignant transformation data where the original progression was determined by independent review. More details are described in Section 4.4.2.1.4.

4.3.2.4 Modelling of time to treatment discontinuation

The EAG notes that data for the time to treatment discontinuation due to other reasons have very limited number events and follow-up. The company has chosen the model which provides the lowest probability of continuing the treatment. A few other models provide equal good fit to the data based on both goodness-of-fit statistics and visual inspection of the fit against the KM data.

The EAG's preferred model is the exponential (the same as the company's base case) and select the lognormal with the highest probability of continuing the treatment in a scenario analysis.

4.3.2.5 Utility values – the decrement for non-progressed LGG

The company calculated this decrement by using Drewes *et al.* and matching the age of LGG patients who responded to the EQ-5D questionnaire in Drewes *et al.* to the population norms in Jansen *et al.*⁵⁷

⁵⁹ The EAG believes that only one source, Hernandez Alava *et al.* should be used to calculate population norms, when the studies obtain utility values using the EQ-5D questionnaire and the UK value set, as was the case in Drewes *et al.*^{1, 57, 62, 63}

4.3.3 HGG only

4.3.3.1 Modelling of time to progression or death (PFS)

The EAG disagrees with the company's survival extrapolation approach for PFS for the following reasons: (i) investigator assessed PFS is not used routinely in practice to determine progression; (ii) a constant HR was assumed for a lifetime which has not been justified by the company; (iii) the hybrid extrapolation approach (KM followed by a parametric model for the tail) is highly arbitrary.

The company uses investigator determined progression from the TADPOLE HGG cohort in the base case and states that “*Clinical experts indicated that PFS as assessed by the investigator is a more accurate reflection of when a patient would be deemed to have progressive disease in clinical practice, and is a more accurate reflection of the decision for when to stop treatment.*” The EAG disagrees with the use of investigator assessed PFS for efficacy because the standard approach for determining progression in clinical reviews is independent review, which was confirmed by the EAG's clinical advisors. The EAG believes that independent review determined PFS should be used to determine progression.

The company extrapolated the HGG cohort to inform the modelling of PFS for the D+T arm and applied an IPTW-adjusted HR to model the TMZ arm for the no prior TMZ subgroup. For patients in the control arm in the prior TMZ subgroup, PFS was effectively assumed to be fixed at time 0 as they all started the model in the progressed health state. The EAG disagrees with applying a constant HR to extrapolate the TMZ arm because a constant HR was assumed for a lifetime which has not been justified by the company. The EAG's clinical advisors disagreed with the assumption that the time until another progression was 0 for patients in the control arm in the prior TMZ subgroup.

The EAG also disagrees with the use of hybrid approach with KM data followed by a parametric model to extrapolate survival data for the D+T arm for both prior TMZ and no prior TMZ subgroups as this

approach is highly arbitrary. Furthermore, the uncertainty associated with progression in the period when the KM is used is not propagated properly by the company in their originally submitted model.

The EAG's preferred approach to model PFS for the no prior TMZ subgroup is to independently fit parametric models to the IPTW-adjusted PFS data for the D+T and TMZ arm based on the independent review assessed PFS. The EAG's preferred approach to model PFS for the prior TMZ subgroup is to fit parametric models to the independent review assessed PFS data for the D+T arm. More details are described in Section 4.5.2.

4.3.3.2 Modelling of time to Glioma related death – progressed (PPS)

The EAG disagrees with the use of investigator assessed PFS for efficacy because the standard approach for determining progression in clinical reviews is independent review, which was confirmed by the EAG's clinical advisors. The EAG believes that PFS according to independent review should be used to determine progression.

The EAG's preferred approach to model time to Glioma specific death (post-progression after malignant transformation) is to fit parametric models to the post-progression after malignant transformation data where PFS was by independent review. More details are described in Section 4.2.5.1.4.

4.3.3.3 Modelling of time to treatment discontinuation

The EAG notes that data for the time to treatment discontinuation due to other reasons have very limited number events and follow-up. The company has chosen the model which provides the lowest probability of continuing the treatment. A few other models provide equally good fits to the data based on both goodness-of-fit statistics and visual inspection of the fit against the KM data.

The EAG's preferred model is the exponential (the same as the company's base case) and select the Gompertz with the highest probability of continuing the treatment in a scenario analysis.

4.3.3.4 The model has a direct surrogate relationship between time to progression or death (PFS) and the time to glioma related death (OS)

The model predicts a time to PFS, using a probability to determine whether a PFS event is a death or progression, and then estimates a time to post-progression survival (PPS) that is independent of the treatment arm in the model.

This means that (subject to random noise due to the model being an individual level model, and the parametric distribution for the time to event not having a very long tail so that all-cause mortality occurs

before Glioma specific mortality) every year of PFS gained by D+T directly translates into a year of OS. This assumption is hard coded into the analysis.

The ITC results for PFS and OS do show similar large HRs for PFS and OS, however these are not identical (see Table 20 and Table 21).

In the no prior TMZ subgroup and independent assessment of progression, the median OS predicted in the model was [REDACTED] years for D+T and [REDACTED] years for TMZ respectively. the median PFS predicted in the model was [REDACTED] years for D+T and [REDACTED] years for TMZ respectively. The ITC (see Table 20) gave median estimates of overall survival for D+T in years of [REDACTED] and for TMZ of 0.71, (95% CI 0.25, 1.58). For progression free survival (using independent review of progression), the median estimates (in years) were, [REDACTED] for D+T and [REDACTED] for TMZ. The EAG believes that overall survival is likely to be overestimated in the TMZ arm of no prior TMZ subgroup by applying one distribution for PPS after a progression event. It should be noted that when comparing these data, that median's by definition are driven by the time at which a single event occurs.

In the prior TMZ subgroup and independent assessment of progression, the company's model predicts a median OS of [REDACTED] years for D+T and [REDACTED] years for BSC. The company's model predicts a median PFS of [REDACTED] years for D+T and [REDACTED] years for BSC. The ITC (Table 21) gave median estimates of overall survival for D+T of [REDACTED] and for BSC of 0.50 years, (95% CI 0.33, NE). For progression-free survival (using independent review of progression), the median estimates (in years) were, [REDACTED] for D+T and [REDACTED] for TMZ. It should be noted that when comparing these data, that median's by definition are driven by the time at which a single event occurs. In particular, the company places emphasis on the median OS for D+T in the ITC was driven by a single event.

The EAG believes that there may be a misestimation of the overall survival benefit of D+T in comparison to its comparators in the HGG, prior TMZ population. The EAG notes that it may not be possible to completely address this concern as it would require a full restructuring of the company's analyses to be compatible with its individual level simulation. To get compatible estimates of time to events at the patient level, a set of competing risks time to event analyses, with treatment discontinuation (D+T only), progression and death as the events, would need to be undertaken. This may not be possible with the available data.

Box 1: Summary of the main issues identified within the company's health economic model

Both analyses

1. Wastage of comparator treatments and interventions
2. Utilities, all values were sourced from studies in adults
3. Utilities for people progressed HGG
4. Implementation of all cause mortality

LGG only

1. Modelling of PFS
2. Modelling of time to progressed malignant transformation
3. Modelling of time to glioma specific death after a progressed malignant transformation
4. Modelling of time to treatment discontinuation
5. Utilities, source of general population utility when calculating the decrement

HGG only

1. Modelling of PFS
2. Modelling of time to glioma related death (PPS)
3. Modelling of time to treatment discontinuation
4. Surrogate relationship enforced by the model structure between PFS and overall survival

4.4 Exploratory analyses undertaken by the EAG: LGG

4.4.1 Overview of EAG's exploratory analyses

The methods for the EAG's exploratory analyses are provided in Section 4.4.2 with results provided in Section 4.4.3. The EAG has indicated in each case which changes are included in its base case and which are included only in its scenario analyses.

4.4.2 EAG's exploratory analyses – methods

4.4.2.1 EAG's preferred survival extrapolation

The EAG used the results from the company's response to clarification question B2 and B4, presented in clarification response Appendix P, to determine its base case and scenario analysis for the survival extrapolation.¹⁶ The EAG notes that some flexible spline models with multiple knots were not considered due to overfitting. When assessing statistical goodness-of-fit, distributions which had AIC/BIC scores within a difference of 3 points are considered providing equal goodness-of-fit to the data.⁷⁴

4.4.2.1.1 Progression-free survival for C+V based on independent review (TADPOLE LGG cohort)

For the TADPOLE LGG C+V arm PFS using independent review, the goodness-of-fit of the standard parametric models and the spline models are summarised in Table 47. The two-knot normal spline model provides with the lowest AIC score and the lognormal provides the lowest BIC score. The one-knot normal spline, one/two-knot odds spline, lognormal, one/two-knot hazard spline, and the log-logistic models were found to provide similar AIC and BIC scores (less than 3 points difference to minimum AIC/BIC score), which indicates that these candidate models fit the data equally well. These models also all fit the KM data well (see Figure 28). In response to clarification question B4,¹⁶ the company provides unsmoothed hazard plots using the “muhaz” package in R and the smoothed hazard plot using the “bshazard” package in R. However, the EAG deemed that the hazard plots provided by the company are not suitable for assessing internal validity of the extrapolation as the unsmoothed hazard plots appear to be smoothed and the smoothed hazard plots are based on spline models.

The long-term predictions for the C+V PFS using the candidate parametric models are summarised in Table 48. The lognormal distribution provides the lowest survival probability at 5 years and the lognormal, log-logistic, two-knot hazard spline and two-knot normal spline all provide approximately the same survival probability of ■ at 10 years. All models provided survival predictions at 5 years that were consistent with the EAG's clinical expert prediction of less than 10% survival at 5 years.

Based on the assessments above, the EAG's base case model for the C+V PFS using independent review in the LGG cohort is the lognormal.

Table 47: Fit statistics of PFS extrapolation for PFS assessed by independent review in the LGG cohort (adapted from clarification response Appendix P)

C+V independent review			D+T independent review		
Model	AIC	BIC	Model	AIC	BIC
Normal Spline3	250.3	257.7	Exponential	531.7	534.0
Normal Spline4	251.1	260.1	LogLogistic	533.1	537.6
Odds Spline3	251.4	258.9	LogNormal	533.1	537.7
Hazard Spline3	252	259.4	Gamma	533.2	537.8
Odds Spline4	252.1	261.1	Weibull	533.4	538.0
Hazard Spline4	252.4	261.4	Gompertz	533.7	538.2
Normal Spline2	254.5	260.5	GenGamma	534.1	541.4
Normal Spline1	255.4	259.9	Hazard Spline1	534.4	541.2
Odds Spline2	255.7	261.7	Hazard Spline3	534.5	546.0
LogNormal	255.9	258.9	Normal Spline1	534.7	541.5
Hazard Spline2	256.7	262.7	Normal Spline4	534.7	548.4
Odds Spline1	257.2	261.7	Odds Spline1	535.0	541.9
LogLogistic	257.3	260.3	Odds Spline4	535.2	548.9
Hazard Spline1	257.7	262.2	Hazard Spline4	535.2	549.0
Exponential	260.3	261.8	Odds Spline3	535.3	546.8
Gompertz	260.8	263.8	Normal Spline3	535.5	547.0
Weibull	262.3	265.3	Hazard Spline2	536.4	545.6
Gamma	262.3	265.3	Normal Spline2	536.6	545.8
GenGamma	NA	NA	Odds Spline2	537.0	546.2

Abbreviations: AIC, Akaike Information Criterion; BIC, Bayesian Information Criterion.

Bold: models with the lowest AIC/BIC (within three-point difference).

Strikethrough: models with evidence of overfitting.

Figure 28: Independently fitted candidate parametric models for PFS for C+V using independent review in the LGG cohort (adapted from clarification response Appendix P)

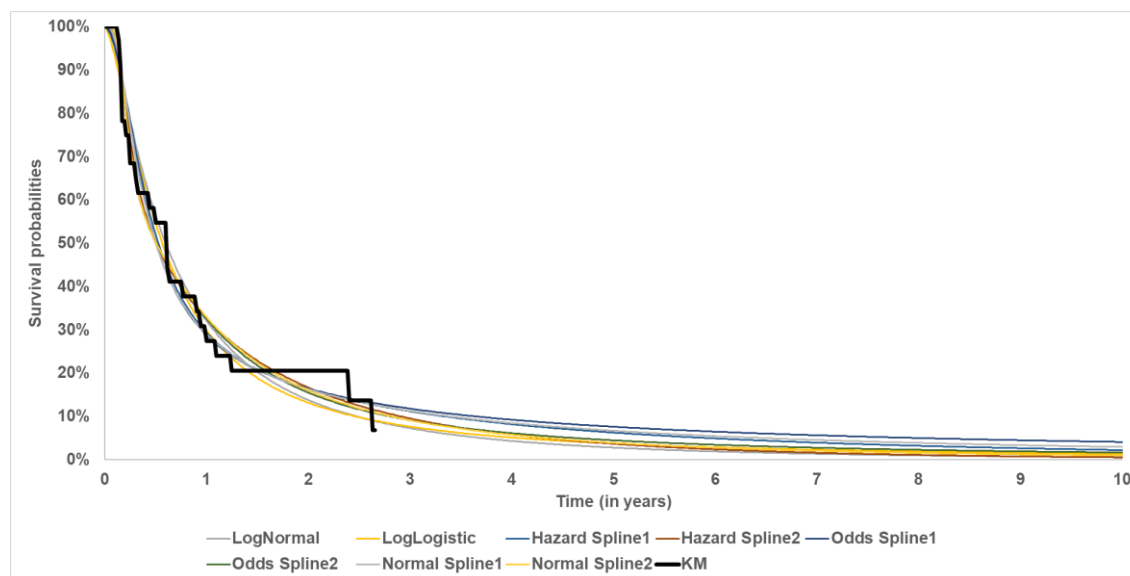

Table 48: PFS predictions using the candidate parametric models for C+V using independent review in the LGG cohort.

Model	5-Year	10-Year
LogNormal	3%	1%
LogLogistic	4%	1%
Hazard Spline1	6%	2%
Hazard Spline2	4%	1%
Odds Spline1	8%	4%
Odds Spline2	4%	2%
Normal Spline1	7%	3%
Normal Spline2	4%	1%

4.4.2.1.2 Progression-free survival for D+T based on independent review (TADPOLE LGG cohort)

For the TADPOLE LGG D+T arm PFS using independent review, the goodness-of-fit of the standard parametric models and spline models are summarised in Table 47. The exponential model provides the lowest AIC and BIC scores. The log-logistic, lognormal, gamma, Weibull, Gompertz, generalised gamma, and the one-knot hazard/normal spline models all have AIC scores within 3 points of the exponential model AIC score, indicating that these candidate models fit the KM data equally well. No other models were found to provide BIC scores within the three-point difference when compared to the exponential model BIC score. These models all fit the KM data well (see Figure 29 and Table 49).

The long-term predictions for the D+T PFS using the candidate are summarised in Table 49. The Weibull, Gompertz and gamma models all provide the lowest survival predictions at 5, 7 and 10 years. Survival probability at 7 years was estimated to be between 15% and 20% by the EAG clinical expert.

The lognormal and log-logistic models give survival probabilities of 15% and 16% respectively at 7 years and thus align closest with the clinical expert opinion.

Based on the assessments above, the EAG’s base case model for the D+T PFS using independent review in the LGG cohort is the log-logistic model.

Figure 29: Independently fitted candidate parametric models for PFS for D+T using independent review in the LGG cohort (adapted from clarification response Appendix P).

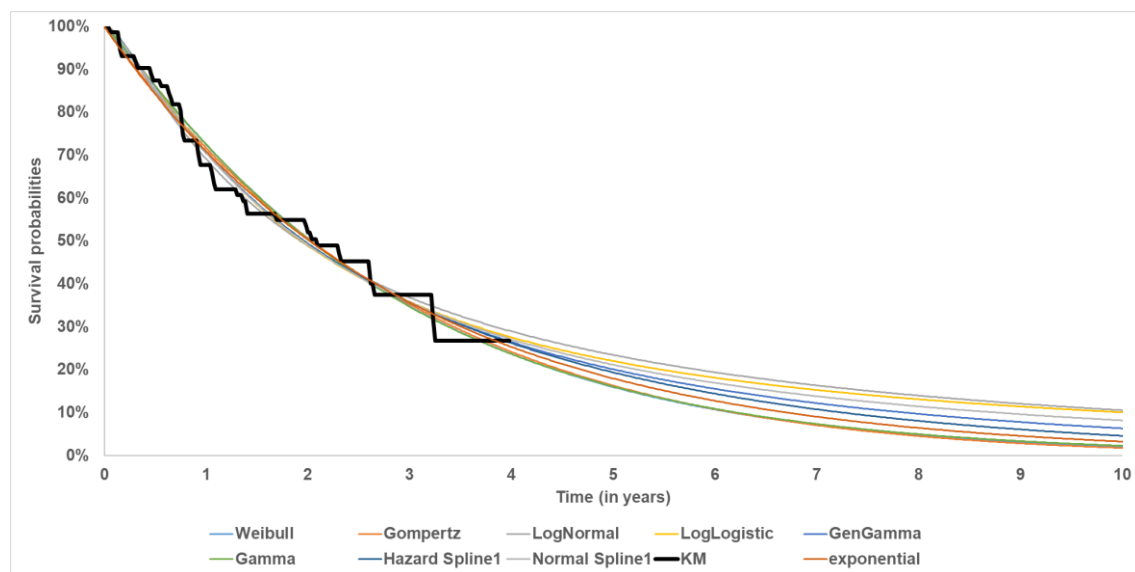

Table 49 PFS predictions using the candidate parametric models for D+T using independent review in the LGG cohort.

Model	5-Year	7-Year	10-Year
Exponential	18%	9%	3%
Weibull	16%	7%	2%
Gompertz	16%	7%	2%
LogNormal	23%	16%	11%
LogLogistic	22%	15%	10%
GenGamma	20%	12%	6%
Gamma	16%	7%	2%
Hazard Spline1	19%	11%	5%
Normal Spline1	21%	14%	8%

4.4.2.1.3 Time to progressed malignant transformation (Jakacki 2016)

The time to progressed malignant transformation was determined using existing EFS data from a study presented in Jakacki *et al.*⁵⁴ The goodness-of-fit of the standard parametric models and the spline models are summarised in Table 50. The two-knot normal spline distribution provides the lowest AIC score and the two-knot odds/hazard splines had scores that differed by less than 3 points when compared to the two-knot normal spline model, indicating that these models all fit the data equally well. Upon visual

inspection of the three candidate models, all were deemed to fit the KM curve well, with minimal difference between the three curves, Figure 30.

The long-term predictions for the EFS Jakacki *et al.* data using the candidate parametric models are summarised in Table 51. The survival probability at 10 years was estimated by the EAG clinical expert to change minimally from the survival probability at 6 years (the final time point of the KM), and thus was assumed to be within the range of 10% to 20%. The two-knot spline models all provide similar 10-year survival probability estimates of between 9% and 10%, however, only the two-knot odds spline model provides a survival probability at 10 years within the range provided by the clinical expert.

Based on the above assessments, the EAG’s base case for the time to progressed malignant transformation is the two-knot odds spline model.

Table 50: Fit statistics of EFS extrapolation from Jakacki 2016 (adapted from clarification response Appendix P)

	AIC	BIC
Normal Spline2	981.9	992.7
Odds Spline2	982.4	993.2
Normal Spline3	983.5	996.9
Hazard Spline2	983.6	994.3
Odds Spline3	983.7	997.2
Hazard Spline3	984.1	997.6
Odds Spline4	985.3	1001.4
Normal Spline4	985.4	1001.5
Hazard Spline4	985.6	1001.7
Odds Spline1	985.6	993.7
Hazard Spline1	986.6	994.6
LogLogistic	986.9	992.3
LogNormal	991.5	996.9
GenGamma	993.5	1001.5
Normal Spline1	993.5	1001.5
Gompertz	993.9	999.3
Exponential	1005.1	1007.8
Weibull	1005.4	1010.8
Gamma	1006.9	1012.2

Abbreviations: AIC, Akaike Information Criterion; BIC, Bayesian Information Criterion.
 Bold: models with the lowest AIC/BIC (within three-point difference).

Figure 30 Independently fitted candidate parametric models for EFS data from Jakacki *et al.* 2016. Adapted from Clarification Response Appendix P

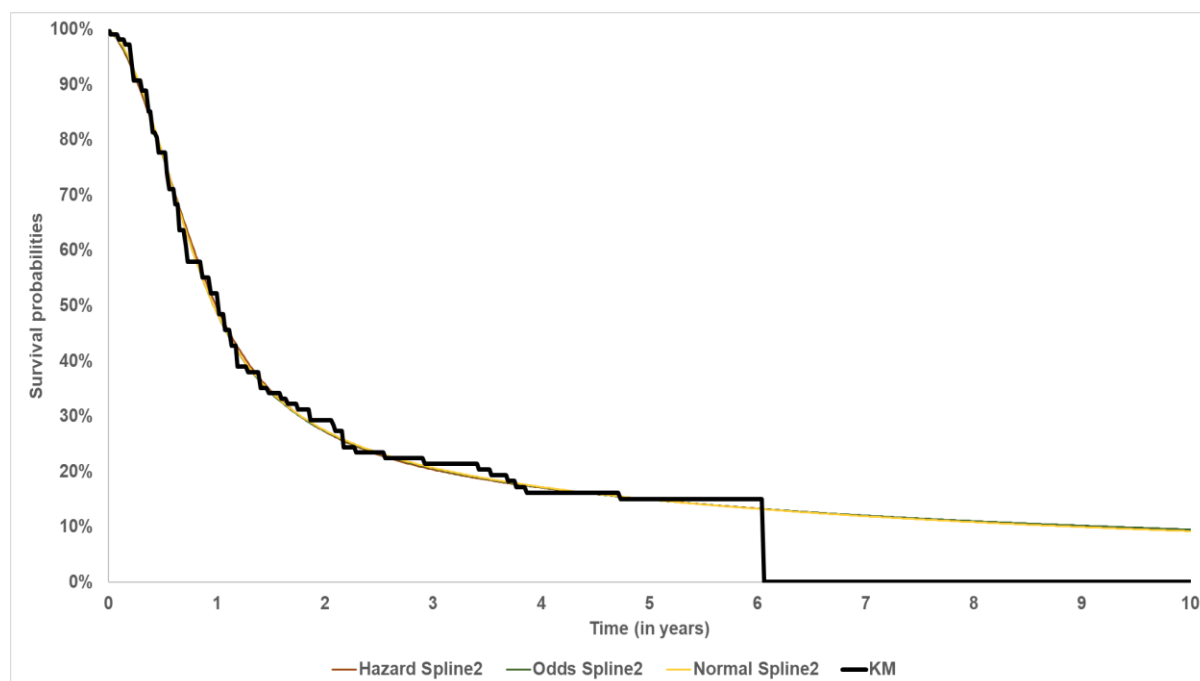

Table 51: EFS predictions using the candidate parametric models extrapolated using the Jakacki 2016 data

Model	5-Year	10-Year
Hazard Spline2	15%	9%
Odds Spline2	15%	10%
Normal Spline2	15%	9%

4.4.2.1.4 Time to Glioma specific death (post-progression after malignant transformation)

For the post-progression mortality after malignant transformation as per independent review, the PPS data from the D+T HGG cohort (pooled TMZ status) was used. The statistical goodness-of-fit for all standard parametric curves and spline models is summarised in Table 52. The one-knot normal spline model provides the lowest AIC score and the lognormal provides the lowest BIC score. The lognormal, one-knot odds/hazard spline, Gompertz, log-logistic and exponential models were all found to have AIC and BIC scores within 3 points of the lowest score. This indicates that these candidate models all provide equally good fits to the KM data.

The visual inspection of the models shows that all models except the exponential model appear to provide good fits to the KM data (Figure 31). The exponential model appears to overestimate the survival probability between 0.5 and 1 year.

Long-term extrapolation of the PPS according to the candidate parametric curves revealed that the Gompertz model plateaus between 5 and 10 years, therefore the Gompertz model was removed from further consideration within the EAG’s model as this is clinically unlikely within the HGG cohort. The survival predictions at 5 and 10 years are summarised in Table 53. The remaining candidate models, excluding the Gompertz, exhibited a range of survival probability between █ for the exponential model and █ for the one-knot odds spline model at 10 years. The EAG clinical expert estimated the survival percentage to be approximately █ at 10 years. The exponential model provided survival estimates at 10 years closest to the expert values but displayed an overall poorer fit to the KM curve. The lognormal and log-logistic models predicted █ survival at 10 years and were the models which provided the second closest predictions to the EAG clinical experts.

Based on the assessments above, the EAG’s base case for the PPS for the D+T TMZ-pooled HGG data is the log-logistic model with a scenario analysis of the one-knot odds spline model.

Table 52: Fit statistics of PPS extrapolation for D+T using independent review of the TMZ-pooled HGG cohort (adapted from clarification response Appendix P)

	AIC	BIC
Normal Spline1	167	170.8
LogNormal	167.3	169.9
Odds Spline1	167.4	171.2
Hazard Spline1	167.6	171.5
Gompertz	168	170.6
LogLogistic	168.5	171.1
Exponential	168.8	170.1
Normal Spline2	168.9	174.1
Odds Spline2	169.2	174.4
Hazard Spline2	169.3	174.5
Normal Spline4	170.2	178
Weibull	170.3	172.9
Normal Spline3	170.3	176.8
Odds Spline4	170.4	178.1
Hazard Spline3	170.4	176.9
Odds Spline3	170.5	176.9
Gamma	170.6	173.2
Hazard Spline4	170.9	178.7
GenGamma	NA	NA

Abbreviations: AIC, Akaike Information Criterion; BIC, Bayesian Information Criterion.

Bold: models with the lowest AIC/BIC (within three-point difference)

Figure 31 Independently fitted candidate parametric models for PPS for TMZ-pooled HGG cohort, according to independent review. Adapted from Clarification Response Appendix P.

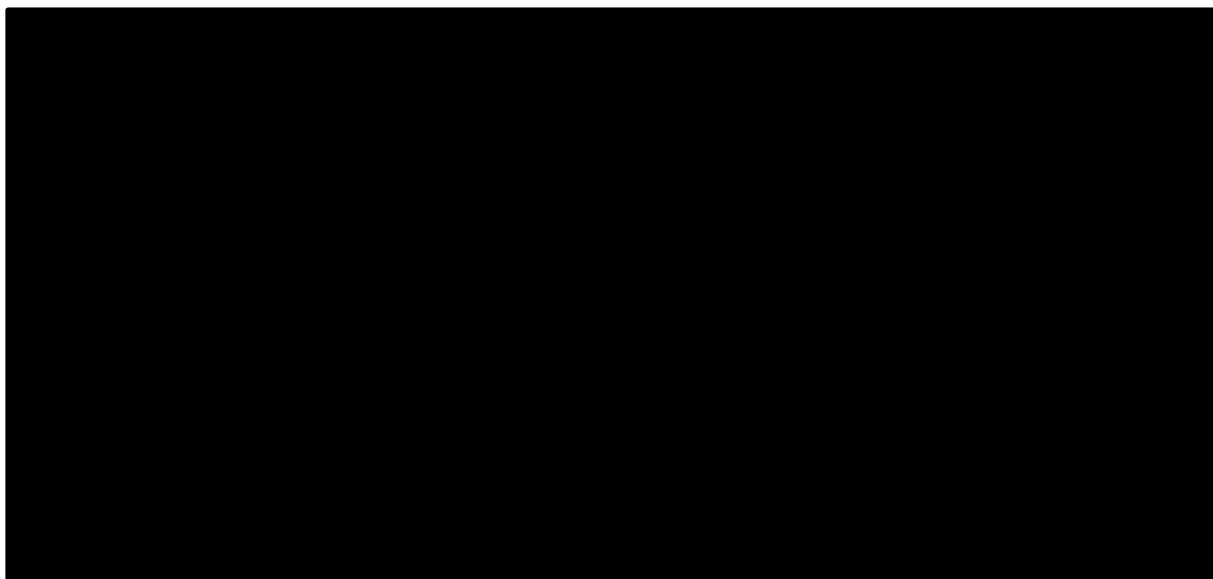

Table 53: PPS predictions using the candidate parametric models for D+T using independent review in the TMZ-pooled HGG cohort.

Model	5-Year	10-Year
Exponential	■	■
Gompertz	■	■
LogNormal	■	■
LogLogistic	■	■
Hazard Spline1	■	■
Odds Spline1	■	■
Normal Spline1	■	■

4.4.2.2 Utility for progressed HGG

As noted in Section 4.3.1.4, the EAG identified a piece of data in Drewes *et al.* that gave the median utility for patients who were alive and had HGG at 6 months. Updating the company’s analyses of the weekly utility decrement for progressed HGG with this value, rather than 1.1% in the company’s base case provides a weekly reduction in utility of 0.32%. Given that this is estimated from median rather than mean utility and that it is lower than the utilities reported in TA121, the EAG believes that the weekly decrement of 0.5% per week should be used for progressed HGG and that 0.32% should be used in a scenario analysis.

4.4.2.3 Wastage

In EAG’s exploratory analyses, we used a costing method that used full vials of treatment for the comparator treatments.

4.5 Exploratory analyses undertaken by the EAG: HGG

4.5.1 Overview of EAG's exploratory analyses

The methods for the EAG's exploratory analyses are provided in Section 4.4.2 with results provided in Section 4.4.3. The EAG has indicated in each case which changes are included in its base case and which are included only in its scenario analyses.

4.5.2 EAG's exploratory analyses – methods

4.5.2.1 EAG's preferred survival extrapolation

4.5.2.1.1 Progression-free survival based on independent review for D+T IPTW adjusted (TADPOLE HGG cohort) for no prior TMZ subgroup

For the D+T for the no prior TMZ subgroup, the PFS was assessed using the IPTW adjusted data provided in clarification response Appendix P. The goodness-of-fit of the standard parametric models and the spline models are summarised in Table 55. The exponential model provides the lowest AIC and BIC score. The lognormal, log-logistic, Gompertz, Weibull and gamma distributions had AIC/BIC scores within 3 points of difference from the lowest scores, indicating that they provide equally good fit to the data. These models except the Gompertz display good fits to the KM data (Figure 32). The Gompertz distribution appears to plateau around 3 years and does not provide a good fit to the KM curve between 2 and 3 years.

The Weibull, exponential, lognormal, log-logistic and gamma parametric models provide survival probability estimates between ■ and ■ at 7 years, Table 55. The EAG clinical expert provided an estimate of 10% survival at 7 years for this subgroup. All candidate models have survival probabilities at 7 years slightly less than the EAG clinical expert estimate, however the lognormal and log-logistic models provide estimates of ■ survival at 7 years.

Based on the above assessments, the EAG's base case for the D+T IPTW adjusted PFS for the no prior TMZ subgroup using independent review is the lognormal distribution.

Table 54: Fit statistics of PFS extrapolation for D+T using independent review, IPTW adjusted for the no prior TMZ subgroup (adapted from clarification response Appendix P)

	AIC	BIC
Normal Spline4	65.7	70.4
Odds Spline4	66.6	71.2
Hazard Spline4	67.9	72.5
Odds Spline3	82.4	86.3
Hazard Spline3	83.5	87.3
Exponential	99.1	99.9
LogNormal	99.5	101
LogLogistic	99.9	101.5
Gompertz	100.3	101.9
GenGamma	100.8	103.1
Weibull	101.1	102.6
Gamma	101.1	102.7
Normal Spline1	101.3	103.6
Odds Spline1	101.6	103.9
Hazard Spline1	101.7	104
Normal Spline2	103.1	106.2
Hazard Spline2	103.2	106.3
Odds Spline2	103.4	106.5
Normal Spline3	NA	NA

Abbreviations: AIC, Akaike Information Criterion; BIC, Bayesian Information Criterion.
 Bold: models with the lowest AIC/BIC (within three-point difference)
 Strikethrough: models with evidence of overfitting.

Figure 32 Independently fitted candidate parametric models for PFS D+T using independent review of the no prior TMZ, IPTW (MAIC) adjusted subgroup in the HGG cohort. Adapted from Clarification Response Appendix P.

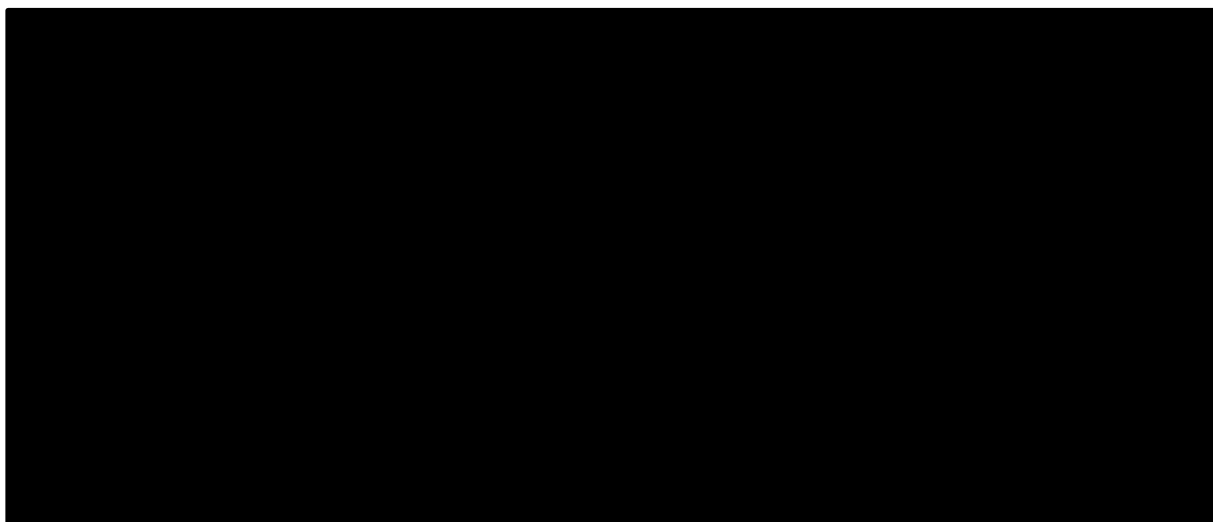

Table 55: PFS predictions using the candidate parametric models for PFS D+T using independent review IPTW adjusted for the no prior TMZ subgroup

Model	5-Year	7-Year	10-Year
Weibull	■	■	■
Exponential	■	■	■
LogNormal	■	■	■
LogLogistic	■	■	■
Gamma	■	■	■

4.5.2.1.2 Progression-free survival based on independent review for TMZ IPTW adjusted (Verschuur 2004) for no prior TMZ subgroup

For the TMZ arm for the no prior TMZ subgroup, the PFS was assessed using the IPTW adjusted data provided in clarification response Appendix P. The goodness-of-fit of the standard parametric models and the spline models are summarised in Table 56. The lognormal curve provides the lowest AIC and BIC scores. The log-logistic, gamma, Weibull, one-knot normal/hazard splines and the exponential have similar AIC/BIC scores (within 3 points difference to the lowest AIC/BIC), which indicates that these models fit the data equally well as the lognormal. These models also provide good fit to the KM data (Figure 33).

The long-term extrapolation of the candidate models provided survival estimates at 1 year no larger than ■, all candidate models gave subsequent estimates at 5 years equal to ■. The EAG clinical expert provided the estimate of 10% survival at 1 year for the TMZ (no prior TMZ) HGG subgroup, suggesting minimal change in survival probability from approximately 6 months.

Based on the above assessments, the EAG’s base case for the IPTW adjusted PFS for the TMZ arm for the no prior TMZ subgroup according to independent review is the log-logistic model. The survival prediction at 1 year using the log-logistic model does not align with the estimate provided by the EAG clinical expert but through discussions with the clinical experts it was made clear that it is not likely for individuals to survive for long periods of time within this group, therefore the EAG chooses to use the statistical models with lower survival extrapolations.

Table 56: Fit statistics of PFS extrapolation for TMZ using independent review of the no prior TMZ, IPTW adjusted, subgroup in the HGG cohort. Adapted from Clarification Response Appendix P.

	AIC	BIC
LogNormal	74	74.7
LogLogistic	74.6	75.4
Gamma	74.9	75.7
Weibull	75.6	76.4
Normal Spline1	75.9	77.1
Exponential	76.3	76.7
Hazard Spline1	76.4	77.6
Odds Spline1	76.6	77.8
Gompertz	77.1	77.9
Normal Spline2	77.9	79.5
Hazard Spline2	78.4	79.9
Odds Spline2	78.6	80.2
Normal Spline3	79.6	81.6
Hazard Spline3	80.1	82.1
Odds Spline3	80.2	82.2
GenGamma	NA	NA
Hazard Spline4	NA	NA
Odds Spline4	NA	NA
Normal Spline4	NA	NA

Abbreviations: AIC, Akaike Information Criterion; BIC, Bayesian Information Criterion.
 Bold: models with the lowest AIC/BIC (within three-point difference)

Figure 33 Independently fitted candidate parametric models for PFS for TMZ using independent review, IPTW adjusted for the no prior TMZ subgroup (adapted from clarification response Appendix P)

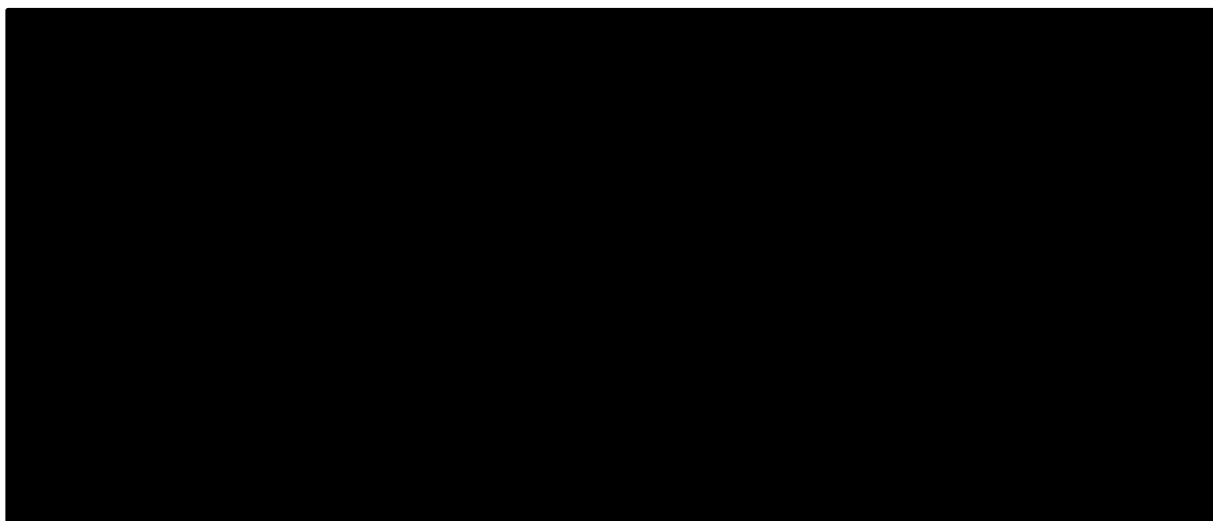

Table 57: PFS predictions using the candidate parametric models for TMZ using independent review of the no prior TMZ, IPTW adjusted subgroup in the HGG cohort.

Model	1-Year	5-Year
Exponential	■	■

Weibull	■	■
LogNormal	■	■
LogLogistic	■	■
Gamma	■	■
Hazard Spline1	■	■
Normal Spline1	■	■

4.5.2.1.3 Progression-free survival based on independent review for D+T (TADPOLE HGG cohort) for prior TMZ subgroup

The goodness-of-fit of the standard parametric models and the spline models are summarised in Table 58. The Gompertz distribution provides the lowest AIC and BIC scores. The one-knot hazard/odds spline, lognormal and log-logistic provides similar AIC/BIC scores (within 3 points difference to the lowest AIC/BIC). Visual inspection of the fitted models with respect to the KM data shows that the lognormal and log-logistic curves provided slightly worse fits to the KM data compared to the Gompertz, and one-knot hazard/odds spline models (Figure 34). The lognormal and log-logistic appeared to slightly overestimate survival between 0.5 and 1.5 years.

The long-term extrapolation of the candidate curves provided a range of survival probability estimates at 10 years between ■ and ■. The Gompertz model appears to plateau and was therefore deemed to be clinically implausible. The EAG clinical experts provided a survival estimate of 15% to 20% at 10 years. The lognormal and log-logistic models predict a survival probability of ■, just below the clinical expert range, and the one-knot hazard/odds spline models predict a survival of ■, just above the expert range.

Therefore, based on the above assessments, the EAG’s base case is the lognormal model despite the relatively lower quality of the fitting, due to the estimate of the lower survival probabilities at 5 years onwards. The one-knot hazard spline model was chosen to be a scenario analysis as it provides the highest survival probability when extrapolated to 10 years without displaying plateau behaviour.

Table 58: Fit statistics of PFS extrapolation for D+T using independent review for the prior TMZ subgroup (adapted from clarification response Appendix P)

	AIC	BIC
Gompertz	144.39	146.57
Hazard Spline1	145.77	149.05
Normal Spline2	145.83	150.19
Odds Spline2	145.96	150.32
Odds Spline1	146.09	149.37
Hazard Spline2	146.18	150.54
Hazard Spline3	146.57	152.03
Odds Spline3	146.57	152.03
LogNormal	146.74	148.92
Normal Spline1	147.15	150.43
GenGamma	147.32	150.60
LogLogistic	147.37	149.56
Hazard Spline4	148.23	154.77
Odds Spline4	148.51	155.05
Normal Spline4	148.92	155.47
Weibull	149.85	152.03
Gamma	150.86	153.04
Exponential	151.46	152.55
Normal Spline3	NA	NA

Abbreviations: AIC, Akaike Information Criterion; BIC, Bayesian Information Criterion.

Bold: models with the lowest AIC/BIC (within three-point difference)

Figure 34 Independently fitted candidate parametric models for PFS for D+T using independent review for the prior TMZ subgroup (adapted from clarification response Appendix P)

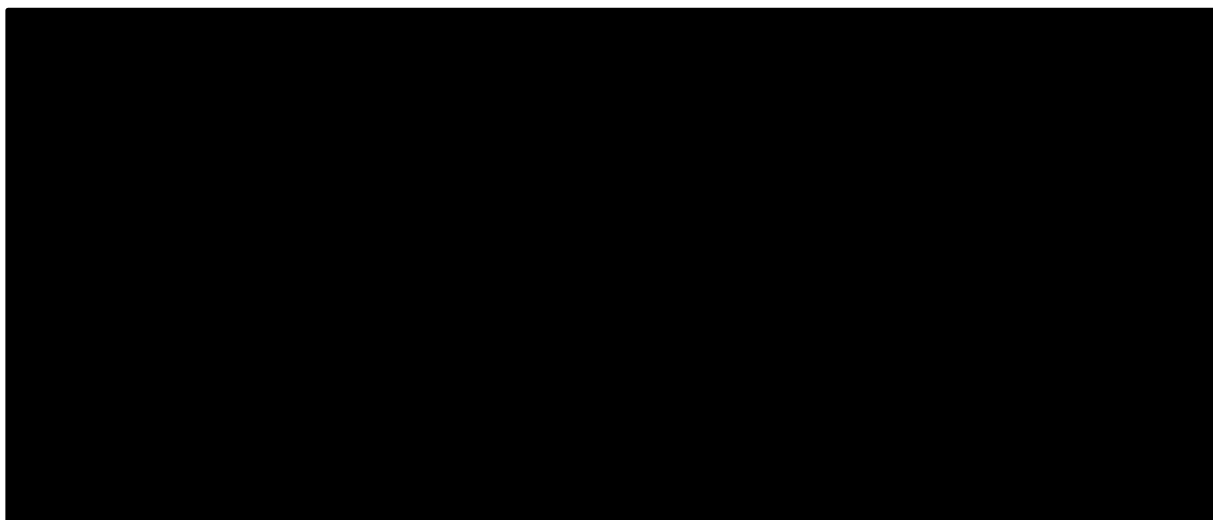

Table 59: PFS predictions using the candidate parametric models for D+T using independent review for the prior TMZ subgroup

Model	5-Year	10-Year
Gompertz	■	■
LogNormal	■	■
LogLogistic	■	■
Hazard Spline1	■	■
Odds Spline1	■	■

4.5.2.1.4 Time to Glioma related death – progressed (PPS)

The assessment of the PPS for the D+T TMZ-pooled HGG group by independent review is summarised in Section 4.4.2.1.3.

5 IMPACT ON THE ICER OF ADDITIONAL CLINICAL AND ECONOMIC ANALYSES UNDERTAKEN BY THE EAG

This section presents the results of the EAG's exploratory analyses.

5.1 LGG

5.1.1 *EAG's preferred base case ICER*

A summary of the EAG scenarios that form part of the EAG's base case model are given in Table 60. The EAG's preferred ICER is lower than the company's ICER. The key driver of this is changing the assumptions in the company's model around PFS. The full details of the EAG base case model, including a rerun of the PSA is given in Table 61. Like the company's base case, it is still appropriate to apply a 1.2 severity weight on QALYs in the EAG's preferred model, as the absolute decrement in QALYs compared to the general population was 17.79 and the proportional shortfall in QALYs was 73.8%.

Table 60: The results of the EAG exploratory analyses that form part of the EAG's base case, applying a 1.2 weight to accrued QALYs

	Incremental QALYs	Incremental costs	ICER
Company's base case	████	████	£25,776
Scenario 1: Change PFS to EAG's base case: independent assessment of disease progression; independent curve fitting; extrapolation for whole time period; Gompertz distribution for D+T, log normal of C+V	████	████	£13,111
Scenario 2: Change distribution for time to progressed malignant transformation to a two knot odds spline model	████	████	£25,773
Scenario 3: Change distribution for time to death after developing a progressed malignant transformation to log logistic	████	████	£25,769
Scenario 4: Change the progressed HGG utility decrement to 0.5% per week	████	████	£25,760
Scenario 5: Use Hernandez <i>et al.</i> to calculate the utility decrement for having LGG	████	████	£26,734
Scenario 6: Implement Wastage for comparator treatments	████	████	£25,557
EAG base case: 1+2+3+4+5+6	████	████	£13,604

Table 61: The full results of the EAG's discounted base case model results in the LGG cohort

Treatment	Total QALYs	Total Costs	ICER (£ per QALY gained)	Expected QALYs in the General population	QALY Shortfall (Absolute / proportional)
Current Practice	6.33	£93,322	-	24.12	17.79 / 73.8%
D+T	████	████████	-	-	-
Incremental	████	████████	£16,325	-	-
Incremental, 1.2 severity modifier	████	████████	£13,604	-	-

QALYs, quality adjusted life years; ICER, incremental cost-effectiveness ratio, D+T, dabrafenib and trametinib

5.1.2 Additional scenarios conducted by the EAG

All additional scenarios were conducted using the EAG's base case model.

5.1.2.1 Scenario 1: Choose a one-knot odds spline model for post-progression survival

Table 62 shows that the model is insensitive to the choice of distribution for post-progression survival for patients who develop a malignant transformation and then experience a progression of their malignant transformation.

Table 62: Results of changing the distribution for post-progression survival after developing a progressed malignantly transformed tumour in the LGG population

Scenario	Incremental QALYs	Incremental Costs	ICER
EAG base case	████	████████	£13,604
Use a one-knot odds spline model for post-progression survival for patients with progressed HGG	████	████████	£13,604

QALYs, quality adjusted life years; ICER, incremental cost-effectiveness ratio, EAG, evidence assessment group; HGG, high grade glioma

5.1.2.2 Scenario 2: Wastage of trametinib

Table 63 shows the effect of scenarios on adding in wastage/spillage of the trametinib bottles. The EAG believes that this shows that the EAG's ICER is largely insensitive to increased wastage of the bottles of trametinib, as even when the spillage/wastage trametinib was at 10%, the EAG's ICER increases from £13,604 per QALY gained in the base case to ██████ per QALY gained.

Table 63: Scenario analysis of adding in a proportion of wastage of the bottles of trametinib

Additional Wastage of Trametinib	0%	2%	4%	6%	8%	10%
ICER	£13,604	██████	██████	██████	██████	██████

ICER, incremental cost-effectiveness ratio

5.1.2.3 Scenario 3: Uncapped treatment duration

The EAG set the cap on treatment duration of D+T to 100 years to effectively uncap the treatment duration, as an extreme scenario, as the stopping rule implemented by the company is not in the draft SmPC.¹³ The full results of this scenario are presented in Table 64. In this scenario the ICER increases from the EAG’s preferred scenario of £13,604 per QALY gained to £20,636 per QALY gained.

Table 64: Results enforcing the stopping of D+T treatment at 100 years

Scenario	Incremental QALYs	Incremental Costs	ICER
EAG base case	██████	██████	£13,604
Patients can remain on D+T for 100 years	██████	██████	£20,636

QALYs, quality adjusted life years; ICER, incremental cost-effectiveness ratio, EAG, evidence assessment group; D+T, dabrafenib and trametinib

5.1.2.4 Scenario 4: Use the company’s preferred PFS assumptions in the EAG model

The model is sensitive to the assumptions around PFS, as changing the PFS assumptions to the company’s preferred values changes the ICER from the EAG’s base case of £13,604 per QALY gained to £26,475 per QALY gained. The results of this scenario are presented in Table 65.

Table 65: Results of changing the distributions for PFS back to the company’s preferred assumptions

Scenario	Incremental QALYs	Incremental Costs	ICER
EAG base case	■	■	£13,604
PFS uses the company’s preferred assumptions	■	■	£26,475

QALYs, quality adjusted life years; ICER, incremental cost-effectiveness ratio, EAG, evidence assessment group; PFS, progression free survival

5.2 HGG

5.2.1 Prior TMZ subgroup

5.2.1.1 EAG’s preferred base case ICER

Table 66 presents the assumptions that form the EAG’s preferred base case ICER. Each scenario is run one at a time from the company’s base case ICER and are then combined into the EAG’s preferred scenario. The company’s base case ICER was £29,214 per QALY gained and the EAG’s preferred base case ICER is £21,512 per QALY gained. The biggest driver of the different ICERs is the different assumptions the EAG prefer around the modelling of progression free survival. The EAG believes that the company was correct to apply a 1.7 severity weight to QALYs, as the absolute shortfall in QALYs compared to the general population is 22.60 QALYs and the proportional shortfall in QALYs is 94.9%.

Table 66: The results of the EAG exploratory analyses that form part of the EAG's base case in the HGG population who are TMZ experienced, applying a 1.7 weight to accrued QALYs

	Incremental QALYs	Incremental costs	ICER
Company's base case	████	████	£29,214
Scenario 1: PFS, independent review, log normal parametric model, extrapolation the entire period	████	████	£22,439
Scenario 2: Change distribution for time to death after developing a progressed malignant transformation to log-logistic	████	████	£29,044
Scenario 3: Change the progressed HGG utility decrement to 0.5% per week	████	████	£29,422
EAG base case: 1+2+3	████	████	£21,512

QALYs, quality adjusted life years; ICER, incremental cost-effectiveness ratio, PFS, progression free survival; HGG, high grade glioma; EAG, evidence assessment group

Table 67: The EAG's discounted base case model results in the HGG cohort who are TMZ experienced

Treatment	Total QALYs	Total Costs	ICER (£ per QALY gained)	Expected QALYs in the General population	QALY Shortfall (Absolute / proportional)
Current Practice	1.21	£62,596	-	23.81	22.60 / 94.9%
D+T	████	████	-	-	-
Incremental	████	████	£36,570	-	-
Incremental, 1.7 severity modifier	████	████	£21,512	-	-

QALYs, quality adjusted life years; ICER, incremental cost-effectiveness ratio, D+T, dabrafenib and trametinib

5.2.1.2 Additional scenarios conducted by the EAG

5.2.1.2.1 Scenario 1: Choose a one-knot odds spline model for post-progression survival

Table 68 shows the effect on the EAG's preferred base case ICER from selecting a one-knot odds spline model for post progression survival in the HGG population who have previously received TMZ. This

change decreases the ICER from £21,512 per QALY gained in the EAG’s preferred base case to £16,938 per QALY gained.

Table 68: Results of changing the distribution for post-progression survival after developing a progressed malignantly transformed tumour in the HGG population who have previously had TMZ

Scenario	Incremental QALYs	Incremental Costs	ICER
EAG base case	██████	██████	£21,512
Use a one-knot odds spline model for post-progression survival for patients with progressed HGG	██████	██████	£16,938

QALYs, quality adjusted life years; ICER, incremental cost-effectiveness ratio; EAG, evidence assessment group; HGG, high grade glioma

5.2.1.2.2 Scenario 2: Wastage of trametinib

Table 69 shows the effect of adding additional wastage of trametinib to the economic analysis to this population. Overall, this EAG believe this effect is unlikely to important to the decision problem, as it increases the ICER from the EAG’s base case of £21,512 to ██████

Table 69: Scenario analysis of adding in a proportion of wastage of the bottles of trametinib in the HGG population who have previously received TMZ

Additional Wastage of Trametinib	0%	2%	4%	6%	8%	10%
ICER	£21,512	██████	██████	██████	██████	██████

ICER, incremental cost-effectiveness ratio

5.2.1.2.3 Scenario 3: Change post progression survival in the control arm

Table 70 shows the effects of altering the PPS distribution in the control arm only. The results here indicate that the ICER only changes from £21,512 per QALY gained to £23,202 per QALY gained when PPS is halved in the control arm. The ICER changes from £21,512 per QALY gained to £16,636 per QALY gained when PPS is doubled in the control arm. These are likely to be extreme scenarios, and the ICER decreases as PPS increases in the control arm. This is because the post progression health state is associated with relatively high costs, but with a 0.5% weekly decline in utility resulting in a relatively low utility for patients in this health state. Whilst the EAG do still have concerns about the structure of the model enforcing a surrogate relationship between PFS and OS, the EAG believe that

separately modelling death, progression and discontinuation are unlikely to have a large impact on the ICER.

Table 70: Results of the scenario analyses where the post progression survival is changed in the control arm compared to D+T

Scenario	Incremental QALYs	Incremental Costs	ICER
EAG base case	■	■	£21,512
PPS is doubled in the control arm	■	■	£16,636
PPS is halved in the control arm	■	■	£23,202

QALYs, quality adjusted life years; ICER, incremental cost-effectiveness ratio; EAG, evidence assessment group; PPS, post progression survival

5.2.1.2.4 Scenario 4: Potential for a 100 year treatment duration

Table 71 shows that if you move to an extreme scenario where patients continue with D+T almost indefinitely, the ICER does shift from £21,512 per QALY gained in the EAG's base case to £28,109 per QALY gained in this scenario. This is potentially important, however the magnitude of the impact will depend on the final licence and the final summary of product characteristics. These were not available to the EAG at the time of writing this report.

Table 71: The results of the scenario where D+T can be given for up to 100 years

Scenario	Incremental QALYs	Incremental Costs	ICER
EAG base case	■	■	£21,512
D+T can be given for up to 100 years	■	■	£28,109

QALYs, quality adjusted life years; ICER, incremental cost-effectiveness ratio; EAG, evidence assessment group; D+T, dabrafenib and trametinib

5.2.1.2.5 Scenario 5: Changes to the parametric modelling of progression free survival

Table 72 shows the effects of two scenarios of modelling PFS on the EAG's base case ICER. If the parametric model is changed to the alternative model identified by the EAG (one-knot hazard spline model), the ICER changes from £21,512 per QALY gained to £18,407 per QALY gained. If the model uses the company's preferred PFS assumptions the ICER changes to £29,311 per QALY gained.

Table 72: The results of the scenarios modelling PFS

Scenario	Incremental QALYs	Incremental Costs	ICER
EAG base case	■	■	£21,512
Use a one-knot hazard spline model for PFS	■	■	£18,407
Use the company's preferred assumptions on PFS	■	■	£29,311

QALYs, quality adjusted life years; ICER, incremental cost-effectiveness ratio; EAG, evidence assessment group; D+T, dabrafenib and trametinib

5.2.2 No prior TMZ subgroup

5.2.2.1 EAG's preferred base case ICER

Table 73: The results of the EAG exploratory analyses that form part of the EAG's base case, applying a 1.7 weight to accrued QALYs

	Incremental QALYs	Incremental costs	ICER
Company's base case	■	■	£28,785
Scenario 1: PFS, independent review, IPTW adjusted, extrapolation for the entire period, D+T uses log normal distribution, C+V uses log logistic distribution	■	■	£27,419
Scenario 2: Change distribution for time to death after developing a progressed malignant transformation to log-logistic	■	■	£28,665
Scenario 3: Change the progressed HGG utility decrement to 0.5% per week	■	■	£28,945
EAG base case: 1+2+3	■	■	£27,500

QALYs, quality adjusted life years; ICER, incremental cost-effectiveness ratio; PFS, progression free survival; D+T, dabrafenib and trametinib; C+V, carboplatin and vincristine; HGG, high grade glioma; EAG, evidence assessment group

Table 74: The detailed results of the EAG's preferred base case ICER in the HGG population who are TMZ naïve

Treatment	Total QALYs	Total Costs	ICER (£ per QALY gained)	Expected QALYs in the General population	QALY Shortfall (Absolute / proportional)
Current Practice	1.36	£67,986	-	23.81	22.45 / 94.3%
D+T	████	████	-	-	-
Incremental	████	████	£46,750	-	-
Incremental, 1.7 severity modifier	████	████	£27,500	-	-

QALYs, quality adjusted life years; ICER, incremental cost-effectiveness ratio; D+T, dabrafenib and trametinib

5.2.2.2 Additional scenarios conducted by the EAG

5.2.2.2.1 Scenario 1: Choose a one-knot odds spline model for post-progression survival

Table 75 shows the effect of changing the parametric model for progression free survival from a log normal distribution in the EAG's base case to a one-knot hazards spline model. This changes the ICER from £27,500 per QALY gained in the base case to £20,376 per QALY gained in this scenario.

Table 75: Results of changing the distribution for post-progression survival after developing a progressed malignantly transformed tumour in the HGG population who have not previously had TMZ

Scenario	Incremental QALYs	Incremental Costs	ICER
EAG base case	████	████	£27,500
Use a one-knot odds spline model for post-progression survival for patients with progressed HGG	████	████	£20,376

QALYs, quality adjusted life years; ICER, incremental cost-effectiveness ratio; EAG, evidence assessment group; HGG, high grade glioma

5.2.2.2.2 Scenario 2: Wastage of trametinib

Table 76 shows the results of the EAG's scenarios of increasing the wastage of trametinib as it distributed in bottles, so there may be some spillage and breakage. This scenario shows that even if 10% of all bottles were to be spilled or broken, the ICER would only increase from £27,500 per QALY gained in the base case to █████ per QALY gained.

Table 76: Scenario analysis of adding in a proportion of wastage of the bottles of trametinib in the HGG population who have not previously received TMZ

Additional Wastage of Trametinib	0%	2%	4%	6%	8%	10%
ICER	£27,500	██████	██████	██████	██████	██████

ICER, incremental cost-effectiveness ratio

5.2.2.2.3 Scenario 3: Change post progression survival in the control arm

Table 77 shows the effects of altering the PPS distribution in the control arm only. The results here indicate that the ICER only changes from £27,500 per QALY gained to £29,115 per QALY gained when PPS is halved in the control arm. The ICER changes from £27,500 per QALY gained to £18,784 per QALY gained when PPS is doubled in the control arm. These are likely to be extreme scenarios, and the ICER decreases as PPS increases in the control arm. This is because the post progression health state is associated with relatively high costs, but with a 0.5% weekly decline in utility resulting in a relatively low utility for patients in this health state. Whilst the EAG do still have concerns about the structure of the model enforcing a surrogate relationship between PFS and OS, the EAG believe that separately modelling death, progression and discontinuation are unlikely to have a large impact on the ICER.

Table 77: Results of the scenario analyses where the post progression survival is changed in the control arm compared to D+T (HGG TMZ naïve)

Scenario	Incremental QALYs	Incremental Costs	ICER
EAG base case	██████	██████	£27,500
PPS is doubled in the control arm	██████	██████	£18,784
PPS is halved in the control arm	██████	██████	£29,115

QALYs, quality adjusted life years; ICER, incremental cost-effectiveness ratio; EAG, evidence assessment group; PPS, post progression survival

5.2.2.2.4 Scenario 4: Potential for a 100 year treatment duration

Table 78 shows that if you move to an extreme scenario where patients continue with D+T almost indefinitely, the ICER does shift from £27,500 per QALY gained in the EAG's base case to £29,592 per QALY gained in this scenario. The EAG believe that this is a relatively small change in the ICER.

Table 78: The results of the scenario where D+T can be given for up to 100 years

Scenario	Incremental QALYs	Incremental Costs	ICER
EAG base case	████	████	£27,500
D+T can be given for up to 100 years	████	████	£29,592

QALYs, quality adjusted life years; ICER, incremental cost-effectiveness ratio; EAG, evidence assessment group; D+T, dabrafenib and trametinib

5.2.2.2.5 Scenario 5: Change the progression free survival assumptions in the EAG base case

Table 79 shows the differences in using the EAG's preferred assumptions on PFS and the company's preferred assumptions. The EAG believe that in this population subgroup overall impact on the ICER is relatively modest, with the ICER changing from £27,500 per QALY gained to £28,870 per QALY gained.

Table 79: The results of the scenario analysis in which the company's preferred assumptions on PFS are run through the EAG's base case model

Scenario	Incremental QALYs	Incremental Costs	ICER
EAG base case	████	████	£27,500
The company's preferred assumptions for PFS	████	████	£28,870

QALYs, quality adjusted life years; ICER, incremental cost-effectiveness ratio; EAG, evidence assessment group; D+T, dabrafenib and trametinib

6 OVERALL CONCLUSIONS

Clinical effectiveness

For the LGG population, the main evidence was derived from the RCT part of the TADPOLE study. The EAG believes that there are three key uncertainties. Firstly, the study has a relatively small sample size. Secondly, the subgroup analyses used to assess HRQoL mean that the EAG believes that these analyses are only exploratory. Finally, the median duration of D+T treatment was at most 140 weeks in TADPOLE but the draft SmPC recommends that treatment can continue until disease progression or until the development of unacceptable toxicity, with continued treatment into adulthood being left to individual physician's assessing the risk to each individual patient.

For the HGG population, the main evidence was derived from the prospective cohort study part of the TADPOLE study. The EAG believes that there are three key uncertainties. Firstly, the study in the HGG population was a single-arm design so the data are only descriptive. Secondly, the EAG believes that

there are key differences between the studies used in ITC. A limited number of covariates were adjusted for in the ITC analysis. The EAG believes that the ITC results should be interpreted with caution. Finally, like the LGG population, the median duration of D+T treatment was at most 140 weeks in TADPOLE but the draft SmPC recommends that treatment can continue until disease progression or until the development of unacceptable toxicity, with continued treatment into adulthood being left to individual physician's assessing the risk to each individual patient.

Cost-effectiveness

In the LGG population, the EAG's preferred ICER is £13,604. The EAG believes that the company was correct in assessing that this population meets the criteria to apply a 1.2 severity weight to QALYs. The key uncertainties that were not assessable or had a large impact on the ICER were: whether using adult utilities in glioma is an acceptable assumption for childhood gliomas; how long D+T will be given to patients in practice, given the draft SmPC does not specify an exact time to stop treatment; the assumptions around the modelling of PFS. The other uncertainties that the EAG identified only had a moderate impact on estimated ICERs.

In the HGG population, the EAG's preferred ICER is £27,500 per QALY gained in the no prior TMZ subpopulation and £21,512 in the prior TMZ experienced population. The EAG believes that the company was correct in applying a 1.7 severity weight to QALYs for the two subgroups within the HGG population. The key uncertainties that were not possible to address or the EAG believes had a large impact on the ICER were: whether using adult utilities in glioma is an acceptable assumption for childhood gliomas; and, how long D+T will be given to patients in practice, given the draft SmPC does not specify an exact time to stop treatment; the use of the ITC evidence in the economic analysis to derive the model results. The other uncertainties that the EAG identified only had a moderate impact on estimated ICERs.

Implications for future research

The EAG believes that the following future research would be useful. Longer term follow-up of the patients recruited into the TADPOLE study will help inform whether the treatment continuation on D+T is an important issue to consider or not. To address the uncertainty in the indirect comparison retrospective cohort studies of current practice should be attempted to improve the quality of studies making up the indirect comparison. Bespoke vignette studies could be performed to address the use of adult utilities within the analysis of a paediatric population.

7 REFERENCES

1. Hernández Alava M., Pudney S., A W. Estimating EQ-5D by Age and Sex for the UK; 2022.
2. Novartis. Dabrafenib with trametinib for treating BRAF V600E mutation-positive glioma in children and young people aged 1 to 17 [ID5104]: Company evidence submission. 2023.
3. Cancer Research UK. Glioma. Available at: <https://www.cancerresearchuk.org/about-cancer/brain-tumours/types/glioma-adults> (Accessed June 2023). 2023.
4. Ostrom QT, Gittleman H, Fulop J, Liu M, Blanda R, Kromer C, *et al.* CBTRUS Statistical Report: Primary Brain and Central Nervous System Tumors Diagnosed in the United States in 2008-2012. *Neuro Oncol* 2015;17 Suppl 4:iv1-iv62.
5. Cancer Research UK. Children's cancer statistics. Available at: <https://www.cancerresearchuk.org/health-professional/cancer-statistics/childrens-cancers> (Accessed July 2023). 2023
6. The Royal Marsden NHS Foundation Trust. High grade glioma. Available at: <https://www.royalmarsden.nhs.uk/your-care/cancer-types/paediatric-cancers/high-grade-glioma> (Accessed June 2023). 2023.
7. The Royal Marsden NHS Foundation Trust. Low-grade glioma. Available at: <https://www.royalmarsden.nhs.uk/your-care/cancer-types/paediatric-cancers/low-grade-glioma> (Accessed June 2023). 2023.
8. Andrews LJ, Thornton ZA, Saincher SS, Yao IY, Dawson S, McGuinness LA, *et al.* Prevalence of BRAFV600 in glioma and use of BRAF Inhibitors in patients with BRAFV600 mutation-positive glioma: systematic review. *Neuro Oncol* 2022;24:528-40.
9. Blionas A, Giakoumettis D, Klonou A, Neromyliotis E, Karydakis P, Themistocleous MS. Paediatric gliomas: diagnosis, molecular biology and management. *Ann Transl Med* 2018;6:251.
10. Brain Tumour Research. Glioma. Available at: <https://www.braintumourresearch.org/info-support/types-of-brain-tumour/glioma> (Accessed June 2023). 2023.
11. Novartis. Clinical study report - Final analysis - April 2023. Phase II open-label global study to evaluate the effect of dabrafenib in combination with trametinib in children and adolescent patients with BRAF V600 mutation positive Low Grade Glioma (LGG) or relapsed or refractory High Grade Glioma (HGG). 2023.
12. National Institute for H, Care E. Dabrafenib with trametinib for treating BRAF V600E mutation-positive glioma in children and young people aged 1 to 17. Final scope. Available at: <https://www.nice.org.uk/guidance/indevelopment/gid-tal1006> [Last accessed 30th August 2023]. 2023.
13. Novartis. Data on file. Dabrafenib for paediatric glioma. Draft Summary of Product Characteristics. 2023.
14. ClinicalTrials.gov. Study of Efficacy and Safety of Dabrafenib in Combination With Trametinib in Pediatric Patients With BRAF V600 Mutation Positive LGG or Relapsed or Refractory HGG Tumors. Available at: <https://www.clinicaltrials.gov/study/NCT02684058> (Accessed September 2023). 2023.
15. National Health Service E. National genomic test directory: National genomic test directory for cancer. In. 20th September 2023 ed; 2023.
16. Novartis. Dabrafenib with trametinib for treating BRAF V600E mutation-positive glioma in children and young people aged 1 to 17 [ID5104]: Clarification Response; 2023.
17. Lasserson TJ, Thomas J, Higgins JPT. Chapter 1: Starting a review. In: Chandler J, Cumpston M, Li T, Page MJ, Welch VA, editors. *Cochrane Handbook for Systematic Reviews of Interventions version 6.4 (updated August 2023)*. 2023.
18. Picton S, Kilday J, Hargrave D, Bailey S, O'Hare P, Ajithkumar T, *et al.* Guidelines for the diagnosis and management of paediatric and adolescent Low-Grade Glioma. *Children's Cancer and Leukaemia Group* 2020.
19. Novartis. Data on file. Individual clinician consultation. 10th August 2023. 2023.
20. Novartis. Data on file. Individual clinician consultation. 15th September 2023. 2023.

21. Downs SH, Black N. The feasibility of creating a checklist for the assessment of the methodological quality both of randomised and non-randomised studies of health care interventions. *J Epidemiol Community Health* 1998;52:377-84.
22. O'Connor SR, Tully MA, Ryan B, Bradley JM, Baxter GD, McDonough SM. Failure of a numerical quality assessment scale to identify potential risk of bias in a systematic review: a comparison study. *BMC Res Notes* 2015;8:224.
23. Hooper P, Jutai JW, Strong G, Russell-Minda E. Age-related macular degeneration and low-vision rehabilitation: a systematic review. *Can J Ophthalmol* 2008;43:180-7.
24. ClinicalTrials.gov. Study to Investigate Safety, Pharmacokinetic (PK), Pharmacodynamic (PD) and Clinical Activity of Trametinib in Subjects With Cancer or Plexiform Neurofibromas and Trametinib in Combination With Dabrafenib in Subjects With Cancers Harboring V600 Mutations. Available at: <https://www.clinicaltrials.gov/study/NCT02124772> (Accessed July 2023). 2023.
25. Coutant M, Lhermitte B, Guérin E, Chammas A, Reita D, Sebastia C, *et al.* Retrospective and integrative analyses of molecular characteristics and their specific imaging parameters in pediatric grade 1 gliomas. *Pediatr Blood Cancer* 2022;69:e29575.
26. van den Bent MJ, Wefel JS, Schiff D, Taphoorn MJ, Jaeckle K, Junck L, *et al.* Response assessment in neuro-oncology (a report of the RANO group): assessment of outcome in trials of diffuse low-grade gliomas. *Lancet Oncol* 2011;12:583-93.
27. Wen PY, Chang SM, Van den Bent MJ, Vogelbaum MA, Macdonald DR, Lee EQ. Response Assessment in Neuro-Oncology Clinical Trials. *J Clin Oncol* 2017;35:2439-49.
28. Louis DN, Perry A, Reifenberger G, von Deimling A, Figarella-Branger D, Cavenee WK, *et al.* The 2016 World Health Organization Classification of Tumors of the Central Nervous System: a summary. *Acta Neuropathol* 2016;131:803-20.
29. Novartis. Data on file. Trametinib for paediatric glioma. Draft Summary of Product Characteristics. 2023.
30. Forrest CB, Bevans KB, Pratiwadi R, Moon J, Teneralli RE, Minton JM, Tucker CA. Development of the PROMIS® pediatric global health (PGH-7) measure. *Quality of Life Research* 2014;23:1221-31.
31. Bouffet E, Georger B, Moertel C, Whitlock JA, Aerts I, Hargrave D, *et al.* Efficacy and Safety of Trametinib Monotherapy or in Combination With Dabrafenib in Pediatric BRAF V600-Mutant Low-Grade Glioma. *J Clin Oncol* 2023;41:664-74.
32. Esmo. Practice Tools. Performance Scales: Karnofsky & ECOG Scores. Available at: <https://oncologypro.esmo.org/oncology-in-practice/practice-tools/performance-scales>.
33. ClinicalTrials.gov. A Trial of Dabrafenib, Trametinib and Hydroxychloroquine for Patients With Recurrent LGG or HGG With a BRAF Aberration. 2023. <https://clinicaltrials.gov/study/NCT04201457> (Accessed 14/12/2023).
34. ClinicalTrials.gov. Dabrafenib Combined With Trametinib After Radiation Therapy in Treating Patients With Newly-Diagnosed High-Grade Glioma. 2023 14/12/2023).
35. ClinicalTrials.gov. Pediatric Long-Term Follow-up and Rollover Study. 2023. <https://clinicaltrials.gov/study/NCT03975829> (Accessed 14/12/2023).
36. Nascimento DDC, Petriz B, Oliveira SDC, Vieira DCL, Funghetto SS, Silva AO, Prestes J. Effects of blood flow restriction exercise on hemostasis: a systematic review of randomized and non-randomized trials. *Int J Gen Med* 2019;12:91-100.
37. van Raath MI, Chohan S, Wolkerstorfer A, van der Horst C, Limpens J, Huang X, *et al.* Clinical outcome measures and scoring systems used in prospective studies of port wine stains: A systematic review. *PLoS One* 2020;15:e0235657.
38. Novartis. Clinical study report - Primary analysis. Phase II open-label global study to evaluate the effect of dabrafenib in combination with trametinib in children and adolescent patients with BRAF V600 mutation positive Low Grade Glioma (LGG) or relapsed or refractory High Grade Glioma (HGG). 2022.
39. FDA. NDA/BLA Multi-disciplinary Review and Evaluation. Available at: <https://www.fda.gov/media/168758/download> (Accessed Nov 2023). 2022.
40. Hargrave DR, Bouffet E, Tabori U, Broniscer A, Cohen KJ, Hansford JR, *et al.* Efficacy and Safety of Dabrafenib in Pediatric Patients with BRAF V600 Mutation-Positive Relapsed or

- Refractory Low-Grade Glioma: Results from a Phase I/IIa Study. *Clin Cancer Res* 2019;25:7303-11.
41. Mackay A, Burford A, Carvalho D, Izquierdo E, Fazal-Salom J, Taylor KR, *et al.* Integrated Molecular Meta-Analysis of 1,000 Pediatric High-Grade and Diffuse Intrinsic Pontine Glioma. *Cancer Cell* 2017;32:520-37.e5.
 42. Lu VM, Alvi MA, McDonald KL, Daniels DJ. Impact of the H3K27M mutation on survival in pediatric high-grade glioma: a systematic review and meta-analysis. *J Neurosurg Pediatr* 2018;23:308-16.
 43. Louis DN, Perry A, Wesseling P, Brat DJ, Cree IA, Figarella-Branger D, *et al.* The 2021 WHO Classification of Tumors of the Central Nervous System: a summary. *Neuro Oncol* 2021;23:1231-51.
 44. Lashford LS, Thiesse P, Jouvet A, Jaspan T, Couanet D, Griffiths PD, *et al.* Temozolomide in malignant gliomas of childhood: a United Kingdom Children's Cancer Study Group and French Society for Pediatric Oncology Intergroup Study. *J Clin Oncol* 2002;20:4684-91.
 45. Verschuur AC, Grill J, Lelouch-Tubiana A, Couanet D, Kalifa C, Vassal G. Temozolomide in paediatric high-grade glioma: a key for combination therapy? *Br J Cancer* 2004;91:425-9.
 46. World Health Organization. WHO handbook for reporting results of cancer treatment; 1979.
 47. Hoffman LM, Veldhuijzen van Zanten SEM, Colditz N, Baugh J, Chaney B, Hoffmann M, *et al.* Clinical, Radiologic, Pathologic, and Molecular Characteristics of Long-Term Survivors of Diffuse Intrinsic Pontine Glioma (DIPG): A Collaborative Report From the International and European Society for Pediatric Oncology DIPG Registries. *J Clin Oncol* 2018;36:1963-72.
 48. MacDonald TJ, Vezina G, Stewart CF, Turner D, Pierson CR, Chen L, *et al.* Phase II study of cilengitide in the treatment of refractory or relapsed high-grade gliomas in children: a report from the Children's Oncology Group. *Neuro Oncol* 2013;15:1438-44.
 49. Narayana A, Kunnakkat S, Chacko-Mathew J, Gardner S, Karajannis M, Raza S, *et al.* Bevacizumab in recurrent high-grade pediatric gliomas. *Neuro Oncol* 2010;12:985-90.
 50. Arber M, Garcia S, Veale T, Edwards M, Shaw A, Glanville JM. Performance of Ovid Medline Search Filters to Identify Health State Utility Studies. *Int J Technol Assess Health Care* 2017;33:472-80.
 51. Kandels D, Pietsch T, Bison B, Warmuth-Metz M, Thomale UW, Kortmann RD, *et al.* Loss of efficacy of subsequent nonsurgical therapy after primary treatment failure in pediatric low-grade glioma patients-Report from the German SIOP-LGG 2004 cohort. *Int J Cancer* 2020;147:3471-89.
 52. Lassaletta A, Zapotocky M, Mistry M, Ramaswamy V, Honnorat M, Krishnatry R, *et al.* Therapeutic and Prognostic Implications of BRAF V600E in Pediatric Low-Grade Gliomas. *J Clin Oncol* 2017;35:2934-41.
 53. Gnekow AK, Kandels D, Tilburg CV, Azizi AA, Opocher E, Stokland T, *et al.* SIOP-E-BTG and GPOH Guidelines for Diagnosis and Treatment of Children and Adolescents with Low Grade Glioma. *Klin Padiatr* 2019;231:107-35.
 54. Jakacki RI, Cohen KJ, Buxton A, Krailo MD, Burger PC, Rosenblum MK, *et al.* Phase 2 study of concurrent radiotherapy and temozolomide followed by temozolomide and lomustine in the treatment of children with high-grade glioma: a report of the Children's Oncology Group ACNS0423 study. *Neuro Oncol* 2016;18:1442-50.
 55. Office for National S. Office for National Statistics (ONS), National life tables: UK. Available at: <https://www.ons.gov.uk/peoplepopulationandcommunity/birthsdeathsandmarriages/lifeexpectancies/datasets/nationallifetablesunitedkingdomreferencetables> [Last accessed: 19th August 2023]. 2023.
 56. National Institute for H, Care E. NICE health technology evaluations: the manual. Available at: <https://www.nice.org.uk/process/pmg36/chapter/introduction-to-health-technology-evaluation> [Last accessed: 30th August 2023]. 2022.
 57. Drewes C, Sagberg LM, Jakola AS, Solheim O. Perioperative and Postoperative Quality of Life in Patients with Glioma—A Longitudinal Cohort Study. *World Neurosurgery* 2018;117:e465-e74.

58. Vera E, Christ A, Grajkowska E, Briceno N, Choi A, Crandon SK, *et al.* Relationship between RANO-PRO Working Group standardised priority constructs and disease progression among malignant glioma patients: A retrospective cohort study. *EClinicalMedicine* 2023;55:101718.
59. Janssen MF, Szende A, Cabases J, Ramos-Goni JM, Vilagut G, Konig HH. Population norms for the EQ-5D-3L: a cross-country analysis of population surveys for 20 countries. *Eur J Health Econ* 2019;20:205-16.
60. Hadi M, Swinburn P, Nalysnyk L, Hamed A, Mehta A. A health state utility valuation study to assess the impact of treatment mode of administration in Gaucher disease. *Orphanet J Rare Dis* 2018;13:159.
61. National Institute for H, Care E. Pembrolizumab for treating relapsed or refractory classical Hodgkin lymphoma after stem cell transplant or at least 2 previous therapies. TA772. Committee Papers. Available at: <https://www.nice.org.uk/guidance/ta772/evidence>. 2022.
62. Rabin R, de Charro F. EQ-5D: a measure of health status from the EuroQol Group. *Ann Med* 2001;33:337-43.
63. Dolan P. Modeling valuations for EuroQol health states. *Med Care* 1997;35:1095-108.
64. Shaw JW, Johnson JA, Coons SJ. US valuation of the EQ-5D health states: development and testing of the D1 valuation model. *Med Care* 2005;43:203-20.
65. Gov.uk. Drugs and pharmaceutical electronic market information tool (eMIT). Available at: <https://www.gov.uk/government/publications/drugs-and-pharmaceutical-electronic-market-information-emit>. 2023.
66. British National F. British National Formulary (BNF). NICE. Available at: <https://bnf.nice.org.uk>. 2023.
67. Sadighi ZS, Curtis E, Zabrowksi J, Billups C, Gajjar A, Khan R, Qaddoumi I. Neurologic impairments from pediatric low-grade glioma by tumor location and timing of diagnosis. *Pediatr Blood Cancer* 2018;65:e27063.
68. National Health Service E. National Cost Collection Data for 2021-2022. Available at: <https://www.england.nhs.uk/costing-in-the-nhs/national-cost-collection>. 2023.
69. Scottish Medicines C. Temozolomide 5, 20, 100 and 250mg capsules (Temodal®). SMC ID: 244/06. Available at: <https://www.scottishmedicines.org.uk/medicines-advice/temozolomide-5-20-100-and-250mg-capsules-temodal-fullsubmission-24406>. 2006.
70. Georghiou T, Bardsley M. Nuffield Trust. Exploring the cost of care at the end of life. Available at: <https://www.nuffieldtrust.org.uk/sites/default/files/2017-01/end-of-life-care-web-final.pdf>. 2014.
71. Law A. Simulation Modeling and Analysis. 5th Edition, edn: McGraw-Hill Higher Education,; 2015.
72. Hatswell AJ, Bullement A, Briggs A, Paulden M, Stevenson MD. Probabilistic Sensitivity Analysis in Cost-Effectiveness Models: Determining Model Convergence in Cohort Models. *Pharmacoeconomics* 2018;36:1421-6.
73. National Institute for H, Care E. Carmustine implants and temozolomide for the treatment of newly diagnosed high-grade glioma. TA121. Available at: <https://www.nice.org.uk/guidance/ta121>. 2007.
74. Burnham KP, Anderson DR. Model Selection and Inference. New York: Springer; 1998.

8 APPENDICES

Appendix 1: How to change the company's model to implement the EAG scenario analyses

All analyses use the company's revised model, submitted on the 30th November 2023.

General set up of the company's model to be their base case analysis

Set the model to the company's base case parameters, except error fixes

- a. Go to the OPTIONS worksheet
- b. Change population (comparator) to LGG (V+C)
- c. Change BSC – method to estimate OS to use PPS as proxy for OS

All other options should be at the base case values

Remove disease severity modifier calculation from the VBA calculations, so that it is done in Excel

- d. Go to the VBA. Go to module sensitivity analysis. Go to macro PSAsub(). Change lines 270-277 of the module to read

$Arr_psa(p, 1) = genpop_Q/patnum_$

$Arr_psa(p, 2) = ((qaly_DT / patnum_) - (qaly_comp / patnum_))$

$Arr_psa(p, 3) = ((qaly_DT / patnum_))$

$Arr_psa(p, 4) = ((qaly_comp / patnum_))$

$Arr_psa(p, 5) = cost_DT / patnum_$

$Arr_psa(p, 6) = cost_comp / patnum_$

$Arr_psa(p, 7) = LY_DT / patnum_ / 52$

$Arr_psa(p, 8) = LY_comp / patnum_ / 52$

EAG reruns of the company model

1. Go to the Worksheet RunAllSA, press the button RUN SA & PSA

LGG

Set up the company's base case analyses:

Go to the OPTIONS worksheet and set the following options

1. Change Population (comparator) to LGG(V+C)
2. Change PFS definition to Investigator Local
3. Change USE KM for PFS1 for LGG to KM+Hazard for V+C
4. Change Cut off to Next to last event
5. Change distribution PFS to Inorm
6. Change PFS by prior treatment (HGG analysis) to Yes
7. Change Source HR HGG for comparator to Adjusted (ITC)
8. Change Distribution time to treatment discontinuation due to reasons other than progression to exp
9. Change Source HGG OS – For comparison against Palliative care only to D+T PPS
10. Change source PPS LGG to Kandels *et al* 2020
11. Change Distribution PPS (HGG) to exp

12. Change Distribution HGG 1L PFS (LGG analysis) to exp
13. Change Source age distribution to TADPOLE
14. Change Gender to TADPOLE
15. Change AE DT to Pooled
16. Change Include AE to Yes
17. Change Regression model for costs to Individual
18. Change Use RDI from Gneknow for V+C to Yes
19. Change Include subsequent treatments for LGG to Yes
20. Change Include decrement utility IV to Yes
21. Change Cost by age and weight (as per TADPOLE) to Yes
22. Change Adjustment PPS LGG to No
23. Change Decrement utility values at entry to Evidence based
24. Change HGG TMZ analysis to HR(CS)
25. Change Utility values - to DSU values
26. Change Correction error in KM.... to Corrected values....
27. Change AE costs to Corrected following EAG Cq(B10)
28. Change eMIT source to Corrected following EAG CQ(C6)
29. Change BSC – method to estimate OS to use PPS as proxy for OS
30. Change PFS independent D+T to CS base case:....

Scenario 1: Change the time to progression or death (LGG),

Change the following settings:

- 1) Change the drop-down Use KM for PFS1 for LGG to extrapolation entire duration
- 2) Change PFS definition drop down to Independent (Central)
- 2) Change PFS independent D+T drop down to Use PFS D+T for independent review assessment
- 4) Go to Worksheet “Key Inputs _ Array”
- 5) change the formula in cell I15 to
“=OFFSET(IF(AND(pop_an=2,iptw_a=2),d_IPTW_PFS_TMZ!\$AW\$28,d_pfs_CQ!\$AW\$28),(\$I\$13-1)*6,0)”
- 6) change the formula in cell I16 to
“=OFFSET(IF(AND(pop_an=2,iptw_a=2),d_IPTW_PFS_TMZ!\$AW\$29,d_pfs_CQ!\$AW\$29),(\$I\$13-1)*6,0)”
- 7) change the formula in cell J15 to
“=OFFSET(IF(AND(pop_an=2,iptw_a=2),d_IPTW_PFS_DT!\$AW\$28,IF(AND(pop_an=1,EAG_B2=2),d_pfs_DT_CQ!\$AW\$28,d_pfs_CQ!\$AW\$28)),(\$J\$13-1)*6,0)”
- 8) change the formula in cell J16 to
“=OFFSET(IF(AND(pop_an=2,iptw_a=2),d_IPTW_PFS_DT!\$AW\$29,IF(AND(pop_an=1,EAG_B2=2),d_pfs_DT_CQ!\$AW\$29,d_pfs_CQ!\$AW\$29)),(\$J\$13-1)*6,0)”
- 9) change cell I13 to 5
- 10) change cell J13 to 4
- 11) Edit the following two VBA functions as follows
Public Function kmpfs3(KM_use, cutoff, distribution, distribution_C, par1, par2, par3, par4, par5, par6, sp1, sp2, sp3, sp4, sp5, sp6, sp7, sp8, sp9, sp10, maxtime, rand_f, hr_f, time_hr_, par1_C,

par2_C, par3_C, par4_C, par5_C, par6_C, sp1_C, sp2_C, sp3_C, sp4_C, sp5_C, sp6_C, sp7_C,
sp8_C, sp9_C, sp10_C) As Variant

Dim k As Integer, x As Integer

haz = 0

haz2 = 0

If KM_use = 2 Then

x = Application.Min(Application.Match(rand_f, array_PFS_km_2, -1) - 0,
cut_offKM_(Trt_arm_, 1) + 1) ' survival at end of KM point selected

haz2 = -Log(array_PFS_km_2(cut_offKM_(Trt_arm_, 1) + 1, 1)) 'cumulative hazard

If x = (cut_offKM_(Trt_arm_, 1) + 1) Then ' so time is predicted after KM

For k = x To maxtime ' sample xx patients in a loop

'DT hazard

t1 = -Log(Survival_function(distribution, par1, par2, par3, par4, par5, par6, sp1, sp2,
sp3, sp4, sp5, sp6, sp7, sp8, sp9, sp10, k + 1))

t0 = -Log(Survival_function(distribution, par1, par2, par3, par4, par5, par6, sp1, sp2,
sp3, sp4, sp5, sp6, sp7, sp8, sp9, sp10, k))

'CV hazard

t1_C = -Log(Survival_function(distribution_C, par1_C, par2_C, par3_C, par4_C,
par5_C, par6_C, sp1_C, sp2_C, sp3_C, sp4_C, sp5_C, sp6_C, sp7_C, sp8_C, sp9_C, sp10_C, k +
1))

t0_C = -Log(Survival_function(distribution_C, par1_C, par2_C, par3_C, par4_C,
par5_C, par6_C, sp1_C, sp2_C, sp3_C, sp4_C, sp5_C, sp6_C, sp7_C, sp8_C, sp9_C, sp10_C, k))

If k <= time_hr_ Then

haz = Application.Min((t1 - t0), (t1_C - t0_C)) ' hazard for DT cannot be higher
than CV

Else

haz = (t1_C - t0_C)

End If

haz2 = haz2 + haz

If haz2 > (-Log(rand_f)) Then Exit For

```
Next k
  kmpfs3 = k
Else
  kmpfs3 = x
End If
Else
  For k = 1 To maxtime ' sample xx patients in a loop
    'DT hazard
    t1 = -Log(Survival_function(distribution, par1, par2, par3, par4, par5, par6, sp1, sp2,
    sp3, sp4, sp5, sp6, sp7, sp8, sp9, sp10, k + 1))
    t0 = -Log(Survival_function(distribution, par1, par2, par3, par4, par5, par6, sp1, sp2,
    sp3, sp4, sp5, sp6, sp7, sp8, sp9, sp10, k))
    'CV hazard
    t1_C = -Log(Survival_function(distribution_C, par1_C, par2_C, par3_C, par4_C,
    par5_C, par6_C, sp1_C, sp2_C, sp3_C, sp4_C, sp5_C, sp6_C, sp7_C, sp8_C, sp9_C, sp10_C, k +
    1))
    t0_C = -Log(Survival_function(distribution_C, par1_C, par2_C, par3_C, par4_C,
    par5_C, par6_C, sp1_C, sp2_C, sp3_C, sp4_C, sp5_C, sp6_C, sp7_C, sp8_C, sp9_C, sp10_C, k))

    If k <= time_hr_ Then
      haz = Application.Min((t1 - t0), (t1_C - t0_C)) ' hazard for DT cannot be higher
than CV
    Else
      haz = (t1_C - t0_C)
    End If

    haz2 = haz2 + haz

    If haz2 > (-Log(rand_f)) Then Exit For
  Next k
  kmpfs3 = k
End If
End Function
Edit this function as follows
Private Function output_time(x)
```

' Proportion of CR/PR vs CR/PR/SD - used for scenario analysis for LGG using PPS from Gneknow
et al (2017)

If Trt_arm_ = 1 Then

 rresp_ = Resp_VC_

Else

 rresp_ = Resp_DT_

End If

'-----

' STEP 1: GENERATE THE TIME TO EVENTS (BEFORE COMBINING THEM - i.e
IDENTIFYING WHICH HAPPENS FIRST)

'-----

'-----

' Time to death from general causes (ONS)

'-----

' changed following CQ

 Time_gpopQ_ = gentime(array_gpop_(1, male_), array_gpop_(3, male_), array_gpop_(4,
male_), array_gpop_(5, male_), 0, 0, 0, 0, 0, 0, 0, 0, 0, 0, 0, 0, 0, 0, 0, 0, rand_gpop_, array_gpop_(2,
male_), start_age_yr_) ' generate time to death from any cause (in Years) based on ONS

 Time_gpopQ_ = (Time_gpopQ_ - start_age_yr_) * 52 ' Time to death in Weeks

 Time_gpop_ = Time_gpopQ_

'-----

' Time to secondary HGG (LGG analysis only) - No sHGG assumed after X years

'-----

' changed following CQ

 Time_sHGG_ = gentime(array_sHGG_(1, 1), array_sHGG_(3, 1), array_sHGG_(4, 1),
array_sHGG_(5, 1), 0, 0, 0, 0, 0, 0, 0, 0, 0, 0, 0, 0, 0, 0, 0, 0, rand_sHGG_, array_sHGG_(2, 1),
max_sHGGt_ * 52) ' after X years, hazard become very low

 If pop_an_ > 1 Then ' For HGG analysis, no secondary HGG (so time greater than last patient
alive)

 Time_sHGG_ = 100 * 52

 End If

'-----

' Time to death following secondary HGG (LGG analysis only)

'-----

' changed following CQ

Time_sHGGd1_ = gentime(array_Par_pps2_(1, 1), array_Par_pps2_(3, 1), array_Par_pps2_(4, 1), array_Par_pps2_(5, 1), array_Par_pps2_(6, 1), array_Par_pps2_(7, 1), array_Par_pps2_(8, 1), array_Par_pps2_(9, 1), array_Par_pps2_(10, 1), array_Par_pps2_(11, 1), array_Par_pps2_(12, 1), array_Par_pps2_(13, 1), array_Par_pps2_(14, 1), array_Par_pps2_(15, 1), array_Par_pps2_(16, 1), array_Par_pps2_(17, 1), array_Par_pps2_(18, 1), 52 * 100, rand_sHGGd_, array_Par_pps2_(2, 1), 100000) ' Time PFS 1L malignant transformatio (Jackaki 2016)

Time_sHGGd2_ = gentime(array_Par_pps2_(1, 2), array_Par_pps2_(3, 2), array_Par_pps2_(4, 2), array_Par_pps2_(5, 2), array_Par_pps2_(6, 2), array_Par_pps2_(7, 2), array_Par_pps2_(8, 2), array_Par_pps2_(9, 2), array_Par_pps2_(10, 2), array_Par_pps2_(11, 2), array_Par_pps2_(12, 2), array_Par_pps2_(13, 2), array_Par_pps2_(14, 2), array_Par_pps2_(15, 2), array_Par_pps2_(16, 2), array_Par_pps2_(17, 2), array_Par_pps2_(18, 2), 52 * 100, rand_sHGGd2_, array_Par_pps2_(2, 2), 100000) ' Time to death following 1L malignant transformation (assume PPS from HGG analysis)

Time_sHGGd_ = Time_sHGGd1_ + Time_sHGGd2_
'-----

' OS time following secondary HGG (LGG analysis)

'-----

Time_1L_sHGG_ = Time_sHGG_ + Time_sHGGd1_ ' time from entry to progression on 1L following malignant transformation

Time_os_sHGG_ = Time_1L_sHGG_ + Time_sHGGd2_ ' time from entry to death from malignant transformation

'-----

' Time to treatment discontinuation due to reason other than progression - if comparator, time =1 (as applied as a one off)

'-----

' changed following CQ

Time_ttd_ = gentime(array_ttd_(1, 1), array_ttd_(3, 1), array_ttd_(4, 1), array_ttd_(5, 1), array_ttd_(6, 1), array_ttd_(7, 1), array_ttd_(8, 1), array_ttd_(9, 1), array_ttd_(10, 1), array_ttd_(11, 1), array_ttd_(12, 1), array_ttd_(13, 1), array_ttd_(14, 1), array_ttd_(15, 1), array_ttd_(16, 1), array_ttd_(17, 1), array_ttd_(18, 1), stp_ * 52, rand_ttd_, array_ttd_(2, 1), 0) ' TTD due to AE only (as discontinuation due to progression is based on PFS as competing events)

Time_ttd_ = Application.Min(Time_ttd_, stp_ * 52) ' when patients would stop treatment (prior discontinuation due to progression)

Time_ttd2_ = Time_ttd_ 'used for generating pfs

```

If Trt_arm_ = 1 Then ' if comparator, TTD not needed
  Time_ttd_ = 1 ' cost applied by the time of progression
  Time_ttd2_ = 52 * 100 ' used to generate pfs - for HGG, HR applied to DT
End If

'-----
' Time to progression other than sHGG and death (accounting for treatment duration)
'-----

If (pop_an_ = 3 And Trt_arm_ = 1) Then
  Time_pfs_ = 0
Else
' changed following CQ
' change following additional CQ###
' in response to B2 to allow extrapolation for DT
  If (pop_an_ = 1 And Trt_arm_ = 2 And EAG_B2_ = 2) Then
    Time_pfs_ = kmpfs3(DT_ext_, cut_offKM_, array_pfs_(1, Trt_arm_), array_pfs_(1, 1),
array_pfs_(3, Trt_arm_), array_pfs_(4, Trt_arm_), array_pfs_(5, Trt_arm_), array_pfs_(6,
Trt_arm_), array_pfs_(7, Trt_arm_), array_pfs_(8, Trt_arm_), array_pfs_(9, Trt_arm_),
array_pfs_(10, Trt_arm_), array_pfs_(11, Trt_arm_), array_pfs_(12, Trt_arm_), array_pfs_(13,
Trt_arm_), array_pfs_(14, Trt_arm_), array_pfs_(15, Trt_arm_), array_pfs_(16, Trt_arm_),
array_pfs_(17, Trt_arm_), array_pfs_(18, Trt_arm_), pfs_stp_ * 52, rand_pfs_, array_pfs_(2,
Trt_arm_), Time_ttd2_, array_pfs_(3, 1), array_pfs_(4, 1), array_pfs_(5, 1), array_pfs_(6, 1),
array_pfs_(7, 1), array_pfs_(8, 1), array_pfs_(9, 1), array_pfs_(10, 1), array_pfs_(11, 1),
array_pfs_(12, 1), array_pfs_(13, 1), array_pfs_(14, 1), array_pfs_(15, 1), array_pfs_(16, 1),
array_pfs_(17, 1), array_pfs_(18, 1))
  Else
    Time_pfs_ = kmpfs(DT_ext_, cut_offKM_, array_pfs_(1, Trt_arm_), array_pfs_(3,
Trt_arm_), array_pfs_(4, Trt_arm_), array_pfs_(5, Trt_arm_), array_pfs_(6, Trt_arm_),
array_pfs_(7, Trt_arm_), array_pfs_(8, Trt_arm_), array_pfs_(9, Trt_arm_), array_pfs_(10,
Trt_arm_), array_pfs_(11, Trt_arm_), array_pfs_(12, Trt_arm_), array_pfs_(13, Trt_arm_),
array_pfs_(14, Trt_arm_), array_pfs_(15, Trt_arm_), array_pfs_(16, Trt_arm_), array_pfs_(17,
Trt_arm_), array_pfs_(18, Trt_arm_), pfs_stp_ * 52, rand_pfs_, array_pfs_(2, Trt_arm_),
Time_ttd2_)
  End If
End If

```

'please note that PFS is sampled until no progression assumed to speedup model (as calculation in a loop if use KM) - link to function above

```
If (pop_an_ = 1 And (Time_pfs_ > pfs_stp_ * 52)) Then
  Time_pfs_ = 5200
End If
```

' For HGG - allow patients (D+T only) to die in PFS (HGG analysis only)

' changed following CQ

```
If (rand_pfs_dth < array_pfs_(19, Trt_arm_) And pop_an_ > 1) Then
  pfs_pps_ = 0
Else
  pfs_pps_ = 1
End If
```

'-----

' Progressor category: (1) very early (<6 month), (2) early (6-18 months), (3) late (>18 months)

'-----

```
If Time_pfs_ < 26 Then ' very early progressor (<6 months) - no data split 0-6 and 6-18
  prog_cat_ = 1
Else
  If Time_pfs_ < 78 Then ' early progressor (6-18 months) - no data split 0-6 and 6-18
    prog_cat_ = 2
  Else
    prog_cat_ = 3 ' late progressor (>18 months)
  End If
End If
```

'-----

' Progressor category (for scenario): (1) PD, (2) SD, (3) PR/CR at 6 month

'-----

If ((Scenario_LGG_OS_ = 2 And pop_an_ = 1) Or (Trt_arm_ = 1 And pop_an_ = 3)) Then ' if scenario for LGG using gnekow, or HGG prior TMZ analysis

```
If Time_pfs_ < 26 Then ' PD/PPS
  prog_cat_ = 4
Else
  If rand_resp_lgg_ > rresp_ Then ' SD/PPS
    prog_cat_ = 5
```

```

    Else
        prog_cat_ = 6 ' PR/CR/PPS
    End If
End If
End If

'-----
' Time to death following progression
'-----
' changed following CQ

If (pop_an_ = 3 And Trt_arm_ = 1 And bsc_met_ > 1) Then
    Time_pps_ = DT_os_ * (1 / array_pfs_(2, Trt_arm_)) ' added at CQ - to allow HR for OS for
D+T for BSC
Else
    Time_pps_ = gentime(array_pps_(1, prog_cat_), array_pps_(3, prog_cat_), array_pps_(4,
prog_cat_), array_pps_(5, prog_cat_), array_pps_(6, prog_cat_), array_pps_(7, prog_cat_),
array_pps_(8, prog_cat_), array_pps_(9, prog_cat_), array_pps_(10, prog_cat_), array_pps_(11,
prog_cat_), array_pps_(12, prog_cat_), array_pps_(13, prog_cat_), array_pps_(14, prog_cat_),
array_pps_(15, prog_cat_), array_pps_(16, prog_cat_), array_pps_(17, prog_cat_), array_pps_(18,
prog_cat_), 52 * 100, rand_pps_, array_pps_(2, prog_cat_), 5 * 52) ' HR applied for 5 years, after
which change in hazard as per paper (Kandels)
End If

'-----
' Time to death from LGG/HGG
'-----
    Time_os_ = Time_pfs_ + (Time_pps_ * pfs_pps_) ' account for those who die upon
progresison (for HGG analysis only)

'-----
' Time to subsequent treatemt (2nd up 5 lines of therapy) - LGG analysis only
' No progression assumed after 10 years in line with clinical advice that patients progression-free
after 10 years, risk of progression is very low
'-----
' changed following CQ
```

```
tpfs2_ = gentime(array_surv_pfs2_(1, 1), array_surv_pfs2_(3, 1), array_surv_pfs2_(4, 1),  
array_surv_pfs2_(5, 1), array_surv_pfs2_(6, 1), array_surv_pfs2_(7, 1), array_surv_pfs2_(8, 1),  
array_surv_pfs2_(9, 1), array_surv_pfs2_(10, 1), array_surv_pfs2_(11, 1), array_surv_pfs2_(12,  
1), array_surv_pfs2_(13, 1), array_surv_pfs2_(14, 1), array_surv_pfs2_(15, 1),  
array_surv_pfs2_(16, 1), array_surv_pfs2_(17, 1), array_surv_pfs2_(18, 1), 52 * 100, rand_pfs2_  
array_surv_pfs2_(2, 1), 100 * 52) ' time to progression 2L
```

```
tpfs3_ = gentime(array_surv_pfs2_(1, 1), array_surv_pfs2_(3, 1), array_surv_pfs2_(4, 1),  
array_surv_pfs2_(5, 1), array_surv_pfs2_(6, 1), array_surv_pfs2_(7, 1), array_surv_pfs2_(8, 1),  
array_surv_pfs2_(9, 1), array_surv_pfs2_(10, 1), array_surv_pfs2_(11, 1), array_surv_pfs2_(12,  
1), array_surv_pfs2_(13, 1), array_surv_pfs2_(14, 1), array_surv_pfs2_(15, 1),  
array_surv_pfs2_(16, 1), array_surv_pfs2_(17, 1), array_surv_pfs2_(18, 1), 52 * 100, rand_pfs3_  
array_surv_pfs2_(2, 1), 100 * 52) ' time to progression 3L
```

```
tpfs4_ = gentime(array_surv_pfs2_(1, 1), array_surv_pfs2_(3, 1), array_surv_pfs2_(4,  
1), array_surv_pfs2_(5, 1), array_surv_pfs2_(6, 1), array_surv_pfs2_(7, 1), array_surv_pfs2_(8, 1),  
array_surv_pfs2_(9, 1), array_surv_pfs2_(10, 1), array_surv_pfs2_(11, 1), array_surv_pfs2_(12,  
1), array_surv_pfs2_(13, 1), array_surv_pfs2_(14, 1), array_surv_pfs2_(15, 1),  
array_surv_pfs2_(16, 1), array_surv_pfs2_(17, 1), array_surv_pfs2_(18, 1), 52 * 100, rand_pfs4_  
array_surv_pfs2_(2, 1), 100 * 52) ' time to progression 4L
```

```
tpfs5_ = gentime(array_surv_pfs2_(1, 1), array_surv_pfs2_(3, 1), array_surv_pfs2_(4,  
1), array_surv_pfs2_(5, 1), array_surv_pfs2_(6, 1), array_surv_pfs2_(7, 1), array_surv_pfs2_(8, 1),  
array_surv_pfs2_(9, 1), array_surv_pfs2_(10, 1), array_surv_pfs2_(11, 1), array_surv_pfs2_(12,  
1), array_surv_pfs2_(13, 1), array_surv_pfs2_(14, 1), array_surv_pfs2_(15, 1),  
array_surv_pfs2_(16, 1), array_surv_pfs2_(17, 1), array_surv_pfs2_(18, 1), 52 * 100, rand_pfs5_  
array_surv_pfs2_(2, 1), 100 * 52) ' time to progression 5L
```

```
If tpfs2_ > (10 * 52) Then ' no progression after 10 years as per clinical advice
```

```
tpfs2_ = 5200
```

```
End If
```

```
If tpfs3_ > (10 * 52) Then ' no progression after 10 years as per clinical advice
```

```
tpfs3_ = 5200
```

```
End If
```

```
If tpfs4_ > (10 * 52) Then ' no progression after 10 years as per clinical advice
```

```
tpfs4_ = 5200
```

```
End If
```

```
If tpfs5_ > (10 * 52) Then ' no progression after 10 years as per clinical advice
    tpfs5_ = 5200
End If
```

```
Time_pfs2_ = Time_pfs_ + tpfs2_ ' time to progression after 2L
Time_pfs3_ = Time_pfs2_ + tpfs3_ ' time to progression after 3L
Time_pfs4_ = Time_pfs3_ + tpfs4_ ' time to progression after 4L
Time_pfs5_ = Time_pfs4_ + tpfs5_ ' time to progression after 5L
```

```
'-----
```

```
' STEP 2: IDENTIFY WHICH EVENT COMES FIRST
```

```
'-----
```

```
'-----
```

```
' Determining the first event
```

```
'-----
```

```
    Time_gpopC_ = Time_gpop_ ' Time to death general population
    Time_osC_ = Application.Min(Time_gpopC_, Time_os_, Time_os_sHGG_) ' Minimum
time to death (gen pop or death from LGG or death from sHGG)
    Time_sHGGC1L_ = Application.Min(Time_1L_sHGG_, Time_osC_) ' Minimum time
1L sHGG
    Time_sHGGC_ = Application.Min(Time_sHGG_, Time_osC_, Time_sHGGC1L_) ' Time to
sHGG; minimum time to death and time to sHGG
    Time_pfsC_ = Application.Min(Time_pfs_, Time_osC_, Time_sHGGC_) ' Time to pfs;
minimum of time to pfs or death or sHGG
```

```
If pop_an_ = 1 Then ' LGG analysis
```

```
    Time_ttdC_ = Application.Min(Time_ttd_, Time_pfsC_) 'time to treatment
discontinuation; minimum time to discontinuation and pfs
```

```
    Time_pfs2C_ = Application.Min(Time_pfs2_, Time_osC_, Time_sHGGC_)
```

```
    Time_pfs3C_ = Application.Min(Time_pfs3_, Time_osC_, Time_sHGGC_)
```

```
    Time_pfs4C_ = Application.Min(Time_pfs4_, Time_osC_, Time_sHGGC_)
```

```
    Time_pfs5C_ = Application.Min(Time_pfs5_, Time_osC_, Time_sHGGC_)
```

```
Else ' HGG analysis
```

```
    Time_ttdC_ = Application.Min(Time_ttd_, Time_pfsC_) 'time to treatment
discontinuation; minimum time to discontinuation and pfs
```

```
    Time_pfs2C_ = Time_pfsC_
```

```
Time_pfs3C_ = Time_pfsC_  
Time_pfs4C_ = Time_pfsC_  
Time_pfs5C_ = Time_pfsC_  
End If
```

```
tp2 = Time_pfs2C_ - Time_pfsC_           'time in PFS2  
tp3 = Time_pfs3C_ - Time_pfs2C_         'time in PFS3  
tp4 = Time_pfs4C_ - Time_pfs3C_         'time in PFS4  
tp5 = Time_pfs5C_ - Time_pfs4C_         'time in PFS5  
tp6 = Time_sHGGC_ - Time_pfs5C_        'time in PD
```

'-----

' Understanding events for PFS (0) progression, (1) sHGG, (2) death

'-----

```
If Time_pfsC_ = Time_pfs_ Then           ' RANO progression  
    pfs_e_ = 0  
Else  
    If Time_pfsC_ = Time_sHGG_ Then      ' malignant transformation  
        pfs_e_ = 1  
    Else  
        pfs_e_ = 2  
    End If  
End If  
End If
```

'-----

' Understanding events for TTD (0) discontinuation due to AE, (1) other reasons including progression

'-----

```
If Time_ttdC_ = Time_ttd_ Then           'discontinuation due to AE  
    ttd_e_ = 0  
Else  
    ttd_e_ = 1                           ' discontinuation due to progression/death  
End If
```

'-----

' Understanding events for malignant transformation (0) malignant transformation, (1) death before transformation

'-----

```
If Time_sHGGC_ = Time_sHGG_ Then
    sHGG_e_ = 0                    'malignant transformation
Else
    sHGG_e_ = 1                    'death before transformation
End If
```

'-----

' Understanding OS events (0) death from condition, (1) secondary HGG, (2) gen pop

'-----

```
If Time_osC_ = Time_os_ Then                    ' death from Glioma
    os_e_ = 0
Else
    If Time_osC_ = Time_os_sHGG_ Then                    ' death from malignant
transformation
        os_e_ = 1
    Else
        os_e_ = 2                    ' death from general causes
    End If
End If
```

'-----

' Mean time sHGG

'-----

```
mean_timeHGG_ = Time_osC_ - Time_sHGGC_                    'Mean time for those who
transfrom to malignant glioma
```

'-----

' Mean time PPS

'-----

```
If pfs_e_ = 1 Then ' if PFS is due to HGG, then mean time in PPS is zero
    mean_timePPS_ = 0
Else
    mean_timePPS_ = Time_sHGGC_ - Time_pfsC_
End If
```

End Function

Private Function output_C_Q()

'-----

' Time in health states

'-----

output_time (x)

'-----

'Costs

'-----

'-----

'PFS follow-up cost

'please note FU cost is already discounted in Excel - Calculation here only take the cumulative cost at the point of progression or maximum time

' + 1 added so that if pfs time =0, the follow up for zero

'maximum is 10 years

' for HGG, for BSC, for PFS assume cost for palliative care

'-----

If (pop_an_ = 3 And Trt_arm_ = 1) Then

 PFS_FU_c_ = OutcomePerTime(0, Time_pfsC_, Pal_c_, d_cost_)

Else

 PFS_FU_c_ = array_FUc_(WorksheetFunction.Min(Time_pfsC_, 10 * 52), Trt_arm_)

End If

'-----

' Define if cost - if time to subsequent line before time to sHGG (e.g before death or time at death) then apply cost

' used for LGG as for HGG, patient move to PPS directly

'-----

'2nd line

 If (Time_pfs2C_ < Time_sHGGC_ And Time_pfs2C_ > Time_pfsC_) Then

 c_pfs2 = array_costSubS_(1, 1) / ((1 + d_cost_) ^

WorksheetFunction.RoundDown(Time_pfs2C_ / 52, 0))

 Else

```
c_pfs2 = 0
Q_f_HGG1 = 1
End If

'3rd line
If (Time_pfs3C_ < Time_sHGGC_ And Time_pfs3C_ > Time_pfs2C_) Then
    c_pfs3 = array_costSubS_(2, 1) / ((1 + d_cost_) ^
WorksheetFunction.RoundDown(Time_pfs3C_ / 52, 0))
Else
    c_pfs3 = 0
    Q_f_HGG2 = 1
End If

'4th line
If (Time_pfs4C_ < Time_sHGGC_ And Time_pfs4C_ > Time_pfs3C_) Then
    c_pfs4 = array_costSubS_(3, 1) / ((1 + d_cost_) ^
WorksheetFunction.RoundDown(Time_pfs4C_ / 52, 0))
Else
    c_pfs4 = 0
    Q_f_HGG3 = 1
End If

'5th line
If (Time_pfs5C_ < Time_sHGGC_ And Time_pfs5C_ > Time_pfs4C_) Then
    c_pfs5 = array_costSubS_(4, 1) / ((1 + d_cost_) ^
WorksheetFunction.RoundDown(Time_pfs5C_ / 52, 0))
Else
    c_pfs5 = 0
    Q_f_HGG4 = 1
End If

'6th line
If (Time_sHGGC_ < Time_osC_ And Time_sHGGC_ > Time_pfs5C_) Then
    c_pfs6 = 0
Else
    c_pfs6 = 0
    Q_f_HGG5 = 1
End If
```

```

'-----
'Cost for subsequent treatments/PPS
'
'-----
'subsequent cost for high-grade glioma should be 0, as time for subsequent should be equal to 1st
PFS
    If pop_an_ = 1 Then                                'LGG analysis - subsequent treatments
        PPS_FU_c_ = c_pfs2 + c_pfs3 + c_pfs4 + c_pfs5
    Else                                                ' for HGG analysis, use cost for palliative care (annual
cost)
        PPS_FU_c_ = OutcomePerTime(Time_pfsC_, Time_osC_, Pal_c_, d_cost_)
    End If

'Cost associated with high grade glioma (1L cost only)
    If sHGG_e_ = 0 Then                                ' Apply cost to malignant transformation
        sHGG_FU_c_ = c_sHGG_ / ((1 + d_cost_) ^
WorksheetFunction.RoundDown(Time_sHGGC_ / 52, 0))
    Else
        sHGG_FU_c_ = 0
    End If

'-----
'Cost associated with death from condition with exception of sHGG
'
'-----
    If os_e = 0 Then                                    ' Apply cost if death from RANO progression
        OS_c_glioma_ = c_dth_glioma_ / ((1 + d_cost_) ^
WorksheetFunction.RoundDown(Time_osC_ / 52, 0))
    Else
        OS_c_glioma_ = 0
    End If

'-----
'Drug and acquisition costs
'
'-----
    If Trt_arm_ = 1 Then
        If pop_an_ = 3 Then

```

```

        adm_drug_ = 0
        cost_drug_ = 0
    Else
        adm_drug_ = array_comp_cost_(Application.Min(Time_pfsC_, 80), 1) ' Taken
from Array from Excel (already discounted) - cumulative cost at point of progression is taken
        cost_drug_ = array_comp_cost_(Application.Min(Time_pfsC_, 80), 2) ' Taken
from Array from Excel (already discounted) - cumulative cost at point of progression is taken
    End If
    Else
        adm_drug_ = 0
        cost_drug_ = ouctomes(0, Time_ttdC_, array_costDT_, 0, d_cost_) ' Calculated
due to extrapolation beyond trial
    End If
'-----
'Cost and QALY for AEs
'for DT, AE are based on duration of treatment
'for comparator - one off cost and QALY
'-----
    If Trt_arm_ = 1 Then
        AE_c_ = AE_c_comp_ ' Apply as one off
        AE_q_ = -AE_q_comp_ ' Apply as one off
    Else
        AE_c_ = OutcomePerTime(0, Time_ttdC_, AE_c_DT_, d_cost_) ' Adjusted
for exposure
        AE_q_ = -OutcomePerTime(0, Time_ttdC_, AE_q_DT_, d_ben_) ' Adjusted
for exposure

    End If

'-----
'QALYs estimation
'-----

'-----
'QALYs general population
'-----'

```

```

    QALYs_genpop_ = ouctomes(0, Time_gpopQ_, array_input_gender_, array_utilityHS_(1, 1),
d_ben_) ' QALY for general population - severity modifier

```

```

'-----

```

```

'QALYs PFS

```

```

'-----

```

```

    QALYs_pfs1_ = ouctomes(0, Time_pfsC_, array_input_gender_, array_utilityHS_(2, 1),
d_ben_) ' QALY for PF1

```

```

    QALYs_pfs2_ = ouctomes(Time_pfsC_, Time_pfs2C_, array_input_gender_,
array_utilityHS_(2, 1) + array_utilityHS_(3, 1), d_ben_) ' QALY for PF2

```

```

    QALYs_pfs3_ = ouctomes(Time_pfs2C_, Time_pfs3C_, array_input_gender_,
array_utilityHS_(2, 1) + array_utilityHS_(3, 1) + array_utilityHS_(4, 1), d_ben_) ' QALY for PF3

```

```

    QALYs_pfs4_ = ouctomes(Time_pfs3C_, Time_pfs4C_, array_input_gender_,
array_utilityHS_(2, 1) + array_utilityHS_(3, 1) + array_utilityHS_(4, 1) + array_utilityHS_(5, 1),
d_ben_) ' QALY for PF4

```

```

    QALYs_pfs5_ = ouctomes(Time_pfs4C_, Time_pfs5C_, array_input_gender_,
array_utilityHS_(2, 1) + array_utilityHS_(3, 1) + array_utilityHS_(4, 1) + array_utilityHS_(5, 1) +
array_utilityHS_(6, 1), d_ben_) ' QALY for PF5

```

```

    QALYs_pfs_ = QALYs_pfs1_ + QALYs_pfs2_ + QALYs_pfs3_ + QALYs_pfs4_ +
QALYs_pfs5_ ' QALY for PF (1-5)

```

```

'-----

```

```

'QALYs PPS

```

```

'-----

```

```

    If pop_an_ = 1 Then                                     ' use time sHGG To capture if sHGG
happen before

```

```

        QALYs_pps_ = ouctomes(Time_pfs5C_, Time_sHGGC_, array_input_gender_,
(array_utilityHS_(2, 1) + array_utilityHS_(3, 1) + array_utilityHS_(4, 1) + array_utilityHS_(5, 1)
+ array_utilityHS_(6, 1) + array_utilityHS_(7, 1)), d_ben_)

```

```

    Else                                                     ' for HGG, assume weekly decrement

```

```

        QALYs_pps_ = QALYspps(Time_pfsC_, Time_osC_, array_utilityHS_(2, 1),
array_utilityHS_(9, 1), array_utilityHS_(10, 1))

```

```

    End If

```

```

'-----

```

```

'QALYs secondary HGG

```

```

'-----

```

'First need to identify the utility at the point of malignant transformation

U_start_shgg = array_utilityHS_(2, 1) + array_utilityHS_(3, 1) * Q_f_HGG1 + array_utilityHS_(4, 1) * Q_f_HGG2 + array_utilityHS_(5, 1) * Q_f_HGG3 + array_utilityHS_(6, 1) * Q_f_HGG4 + array_utilityHS_(7, 1) * Q_f_HGG5 + array_utilityHS_(8, 1)

'Calculate QALY for malignant transformation - progressive worsening in QoL

QALYs_sHGG_ = ouctomes(Time_sHGGC_, Time_sHGGC1L_, array_input_gender_, U_start_shgg, d_ben_) + QALYspps(Time_sHGGC1L_, Time_osC_, U_start_shgg, array_utilityHS_(9, 1), array_utilityHS_(10, 1))

'-----

'QALYs IV loss

'-----

If Trt_arm_ = 1 Then

 QALYs_IV_ = -Qol_IV_ 'for chemotherapy, apply disutility
due to IV admin

Else

 QALYs_IV_ = 0

End If

Arr_e = Array(pop_an_, Trt_arm_, Time_gpopQ_, Time_gpop_, start_age_yr_, start_age_wk_, p_male_, male_, stp1_, stp2_, stp_, "empty", Time_ttd_, Time_ttd2_, Time_pfs_, prog_cat_, Time_pps_, pfs_pps_, Time_os_, tpfs2_, tpfs3_, tpfs4_, tpfs5_, Time_pfs2_, Time_pfs3_, Time_pfs4_, Time_pfs5_, Time_sHGG_, Time_sHGGd_, Time_os_sHGG_, Time_gpopC_, Time_osC_, Time_sHGGC_, Time_pfsC_, Time_ttdC_, pfs_e_, ttd_e_, sHGG_e_, os_e_, QALYs_pfs1_, QALYs_pfs2_, QALYs_pfs3_, QALYs_pfs4_, QALYs_pfs5_, QALYs_pfs_, QALYs_pps_, QALYs_sHGG_, QALYs_genpop_, QALYs_IV_, PFS_FU_c_, c_pfs2, c_pfs3, c_pfs4, c_pfs5, PPS_FU_c_, sHGG_FU_c_, OS_c_glioma_, adm_drug_, cost_drug_, AE_c_, tp2, tp3, tp4, tp5, tp6, mean_timePPS_, mean_timeHGG_, AE_q_)

End Function

Scenario 2: Change the time to progressed malignant transformation

1. Change the cell Distribution HGG 1L PFS (LGG analysis) to splineodd2
2. Run the model by clicking the run model button in the Base Case Results worksheet

Scenario 3: Change the time to PPS

1. Change the cell Distribution PPS (HGG)to llog
2. Run the model by clicking the run model button in the Base Case Results worksheet

Scenario 4: Wastage Use full vials for the comparator therapies

1. Go to the WorkSheet Unit_cost
2. Insert a new column between columns P and Q
3. In cell Q3, write number of vials required
4. In cell Q4 write the formula =ROUNDUP(P4/J4,0)
5. Copy the formula in cell Q4 and copy this into cells Q5, Q6, Q7, Q8, Q9, Q12
6. Add in a new column between rows R and Q
7. In cell R3 write cost per vial
8. In cell R4 write the formula =L4/K4
9. Copy and paste this formula to cells R5, R6, R7, R8, R9, R12
10. Change the formula in cell S4 to be =Q4*R4
11. Copy and paste this formula down to cells S5,S6, S7, S8, S9 and S12

Scenario 5: use the TA121 decrement for HGG HRQoL

1. Go to Worksheet HRQoL & change the value in cell L28 to 0.7
2. Edit the formula in cell H23 to read =MAX(0.005,1-EXP(-(-LN(L28/L27)/0.5)/52))

Scenario 6: Base the utility decrement for having LGG from Hernandez Alava *et al.*

1. In cell K4 add in the mean age reported in Drewes *et al* as =ROUNDUP(46.7,0)
2. In cell L4 add the mean % female from Drewes *et al* as = 13/40
3. In cell I7, change the formula to =(\$L\$4*VLOOKUP(\$K\$4,\$I\$35:\$K\$161,3,FALSE))+((1-\$L\$4)*VLOOKUP(\$K\$4,\$I\$35:\$K\$161,2,FALSE))

EAG base case: 1+2+3+4+5+6

Scenario 7: Additional wastage/spillage of D+T

1. Go to Worksheet DT_cost
2. Add 0% into cell AB3
3. Edit the formula in cell Y4 to be =((W4/(V4*X4))*(1-Z4))*(1+\$AB\$3)
4. For the range of scenarios change AB3 to 2%,4%, 6%, 8%, 10%

Scenario 8: revert back to the company's preferred assumptions for Progression free survival

1. Go to Worksheet OPTIONs
2. Change PFS definition to Investigator (Local)
3. Change Use KM for PFS 1 for LGG to KM+Hazard for V+C
4. Go to worksheet Key Inputs _ Array
5. Change the value in cell J13 to 4

HGG – no prior TMZ

Set up the company's base case

1. Set up the model as per the LGG model
2. In the OPTIONS Worksheet, change the setting Population (comparator) to HGG no prior TMZ (TMZ)
3. In the OPTIONS Worksheet, change the setting Distribution PFS to exp

Scenario 1: Change PFS

4. Go to Worksheet OPTIONS
5. Change the cell in the option HGG TMZ analysis - PFS use HR (CS) or IPTW adjusted data (EAG B2) to IPTW fit (EAG B2)
6. Change the cell in the option PFS definition to Independent (Central)
7. Change the cell in the option PFS independent D+T to Use PFS D+T for independent review assessment
8. Change the cell Use KM for PFS1 for LGG to Extrapolation entire duration
9. Go to worksheet Key Inputs _ Array
10. Change all references to d_pfs contained within the formula in cells I14:I20 to instead refer to \$I\$13
11. Change all references to d_pfs contained within the formula in cells J15:J20 to instead refer to \$I\$13
12. Change cell I13 to 5
13. Change cell J13 to 4
14. Add this code to the VBA module Generate_TTE

```
Public Function kmpfs4(KM_use, cutoff, distribution, distribution_C, par1, par2, par3, par4, par5, par6, sp1, sp2, sp3, sp4, sp5, sp6, sp7, sp8, sp9, sp10, maxtime, rand_f, hr_f, time_hr_, par1_C, par2_C, par3_C, par4_C, par5_C, par6_C, sp1_C, sp2_C, sp3_C, sp4_C, sp5_C, sp6_C, sp7_C, sp8_C, sp9_C, sp10_C) As Variant
```

```
Dim k As Integer, x As Integer
```

```
haz = 0
```

```
haz2 = 0
```

```
If KM_use = 2 Then
```

```
    x = Application.Min(Application.Match(rand_f, array_PFS_km_2, -1) - 0, cut_offKM_(Trt_arm_, 1) + 1) ' survival at end of KM point selected
```

```
    haz2 = -Log(array_PFS_km_2(cut_offKM_(Trt_arm_, 1) + 1, 1)) 'cumulative hazard
```

```
If x = (cut_offKM_(Trt_arm_, 1) + 1) Then ' so time is predicted after KM
```

```
For k = x To maxtime ' sample xx patients in a loop
```

```
    'DT hazard
```

```
        t1 = -Log(Survival_function(distribution, par1, par2, par3, par4, par5, par6, sp1, sp2, sp3, sp4, sp5, sp6, sp7, sp8, sp9, sp10, k + 1))
```

```
t0 = -Log(Survival_function(distribution, par1, par2, par3, par4, par5, par6, sp1, sp2,  
sp3, sp4, sp5, sp6, sp7, sp8, sp9, sp10, k))
```

```
'CV hazard
```

```
t1_C = -Log(Survival_function(distribution_C, par1_C, par2_C, par3_C, par4_C,  
par5_C, par6_C, sp1_C, sp2_C, sp3_C, sp4_C, sp5_C, sp6_C, sp7_C, sp8_C, sp9_C, sp10_C, k + 1))
```

```
t0_C = -Log(Survival_function(distribution_C, par1_C, par2_C, par3_C, par4_C,  
par5_C, par6_C, sp1_C, sp2_C, sp3_C, sp4_C, sp5_C, sp6_C, sp7_C, sp8_C, sp9_C, sp10_C, k))
```

```
If k <= time_hr_ Then
```

```
haz = Application.Max((t1 - t0), (t1_C - t0_C)) ' hazard for CV cannot be lower than
```

```
DT
```

```
Else
```

```
haz = (t1_C - t0_C)
```

```
End If
```

```
haz2 = haz2 + haz
```

```
If haz2 > (-Log(rand_f)) Then Exit For
```

```
Next k
```

```
kmpfs4 = k
```

```
Else
```

```
kmpfs4 = x
```

```
End If
```

```
Else
```

```
For k = 1 To maxtime ' sample xx patients in a loop
```

```
'DT hazard
```

```
t1 = -Log(Survival_function(distribution, par1, par2, par3, par4, par5, par6, sp1, sp2,  
sp3, sp4, sp5, sp6, sp7, sp8, sp9, sp10, k + 1))
```

```
t0 = -Log(Survival_function(distribution, par1, par2, par3, par4, par5, par6, sp1, sp2,  
sp3, sp4, sp5, sp6, sp7, sp8, sp9, sp10, k))
```

```
'CV hazard
```

```
t1_C = -Log(Survival_function(distribution_C, par1_C, par2_C, par3_C, par4_C,  
par5_C, par6_C, sp1_C, sp2_C, sp3_C, sp4_C, sp5_C, sp6_C, sp7_C, sp8_C, sp9_C, sp10_C, k + 1))
```

```
t0_C = -Log(Survival_function(distribution_C, par1_C, par2_C, par3_C, par4_C,  
par5_C, par6_C, sp1_C, sp2_C, sp3_C, sp4_C, sp5_C, sp6_C, sp7_C, sp8_C, sp9_C, sp10_C, k))
```

```
If k <= time_hr_ Then
    haz = Application.Max((t1 - t0), (t1_C - t0_C)) ' hazard for CV cannot be lower than
DT
Else 'if the hazard ratio is off, use DT hazard
    haz = (t1 - t0)
End If

    haz2 = haz2 + haz

If haz2 > (-Log(rand_f)) Then Exit For
Next k
kmpfs4 = k

End If
End Function
```

15. Go to Module Patient_prediction, line 239

```
ElseIf (pop_an_ = 2 And Trt_arm_ = 1 And EAG_B2_ = 2) Then
```

```
    Time_pfs_ = kmpfs4(DT_ext_, cut_offKM_, array_pfs_(1, 2), array_pfs_(1, Trt_arm_),
array_pfs_(3, 2), array_pfs_(4, 2), array_pfs_(5, 2), array_pfs_(6, 2), array_pfs_(7, 2), array_pfs_(8, 2),
array_pfs_(9, 2), array_pfs_(10, 2), array_pfs_(11, 2), array_pfs_(12, 2), array_pfs_(13, 2),
array_pfs_(14, 2), array_pfs_(15, 2), array_pfs_(16, 2), array_pfs_(17, 2), array_pfs_(18, 2), pfs_stp_
* 52, rand_pfs_, array_pfs_(2, Trt_arm_), Time_ttd2_, array_pfs_(3, Trt_arm_), array_pfs_(4,
Trt_arm_), array_pfs_(5, Trt_arm_), array_pfs_(6, Trt_arm_), array_pfs_(7, Trt_arm_), array_pfs_(8,
Trt_arm_), array_pfs_(9, Trt_arm_), array_pfs_(10, Trt_arm_), array_pfs_(11, Trt_arm_),
array_pfs_(12, Trt_arm_), array_pfs_(13, Trt_arm_), array_pfs_(14, Trt_arm_), array_pfs_(15,
Trt_arm_), array_pfs_(16, Trt_arm_), array_pfs_(17, Trt_arm_), array_pfs_(18, Trt_arm_))
```

Scenario 2: Change PPS

1. Change the cell Distribution PPS (HGG) to llog

Scenario 3: Change progressed HGG utility

1. Go to Worksheet HRQoL & change the value in cell L28 to 0.7
2. Edit the formula in cell H23 to read =MAX(0.005,1-EXP(-(-LN(L28/L27)/0.5)/52))

EAG base case 1 + 2 + 3

Additional Scenarios

Scenario: Change the control arm parametric model to a one-knot odds spline model

1. Go to Worksheet Key Inputs _ Array, change the value in cell I13 to 12

Scenario : : Additional wastage/spillage of D+T

1. Go to Worksheet DT_cost
2. Add 0% into cell AB3

3. Edit the formula in cell Y4 to be $=((W4/(V4*X4))*(1-Z4))*(1+\$AB\$3)$
4. For the range of scenarios change AB3 to 2%, 4%, 6%, 8%, 10%

Scenario: Implement increased PPS for comparator

1. Use either of the EAG base case models for HGG
2. Go to worksheet Options, cell R48 type, multiplier for PPS in comparator (exploratory)
3. Go to worksheet Options, cell R49 type 1
4. Name cell R49 Comp_PPS_mult
5. Open the VBA editor
6. Go to the Declaration_variable module
7. Add the following line of code Public EAG_mult_PPS_comp_ As Double somewhere in the module
8. Go to the module patient prediction, on line 51, add the following line of code

```
EAG_mult_PPS_comp_ = Range("Comp_PPS_mult").Value
```

9. Go to the module patient prediction, on line 297, add the following lines of code

```
If ((pop_an_ = 3 Or pop_an_ = 2) And Trt_arm_ = 1) Then
```

```
Time_pps_ = Time_pps_ * EAG_mult_PPS_comp_
```

```
End If
```

Scenario: revert back to the company's base case PFS assumptiuons

1. Go to Sheet OPTIONS,
2. change the cell PFS definition to Investigator (local)
3. change the cell Use KM for PFS1 for LGG to KLM = Hazard for V+C
4. Change HGG TMZ analysis - To HR(CS)
5. Go to Sheet Key Inputs _Array, change the values in cells I13 & J13 to 1

HGG – prior TMZ

Set up the company's base case

1. Set up the model as per the LGG model
2. In the OPTIONS Worksheet, change the setting Population (comparator) to HGG prior TMZ (BSC)
3. In the OPTIONS Worksheet, change the setting Distribution PFS to exp

Scenario 1: Change PFS

1. Go to the Worksheet OPTIONS
2. Change the cell in option KM for PFS1 for LGG to Extrapolation entire duration
3. Change the cell in the option PFS definition to Independent (Central)
4. Change the cell in the option Distribution PFS to llog
5. Change the formula on cell 917 (d_pfs) to =ext_val2

Scenario 2: Change PPS

1. Change the cell Distribution PPS (HGG) to llog

Scenario 3: Change progressed HGG utility

1. Go to Worksheet HRQoL & change the value in cell L28 to 0.7
2. Edit the formula in cell H23 to read =MAX(0.005,1-EXP(-(-LN(L28/L27)/0.5)/52))

EAG base Case 1+2+3

Scenario 4: Additional wastage/spillage of D+T

1. Go to Worksheet DT_cost
2. Add 0% into cell AB3
3. Edit the formula in cell Y4 to be =((W4/(V4*X4))*(1-Z4))*(1+\$AB\$3)
4. For the range of scenarios change AB3 to 2%, 4%, 6%, 8%, 10%

Scenario 5: Implement increased PPS for comparator

10. Use either of the EAG base case models for HGG
11. Go to worksheet Options, cell R48 type, multiplier for PPS in comparator (exploratory)
12. Go to worksheet Options, cell R49 type 1
13. Name cell R49 Comp_PPS_mult
14. Open the VBA editor
15. Go to the Declaration_variable module
16. Add the following line of code Public EAG_mult_PPS_comp_ As Double somewhere in the module
17. Go to the module patient prediction, on line 51, add the following line of code

EAG_mult_PPS_comp_ = Range("Comp_PPS_mult").Value

18. Go to the module patient prediction, on line 297, add the following lines of code

If ((pop_an_ = 3 Or pop_an_ = 2) And Trt_arm_ = 1) Then

Time_pps_ = Time_pps_ * EAG_mult_PPS_comp_

End If

Scenario: Change the PFS assumptions

- a) One-knot hazard spline for PFS

1. Go to the Worksheet Options, Change the Distribution PFS to splinehaz1

- b) Use the company's preferred PFS assumptions
 - 1. Start from the company's base case
 - 2. Combine scenarios 2 and 3 in one model

Single Technology Appraisal

Dabrafenib with trametinib for treating BRAF V600E mutation-positive glioma in children and young people aged 1 to 17 [ID5104]

EAG report – factual accuracy check and confidential information check

“Data owners may be asked to check that confidential information is correctly marked in documents created by others in the evaluation before release.” (Section 5.4.9, [NICE health technology evaluations: the manual](#)).

You are asked to check the EAG report to ensure there are no factual inaccuracies or errors in the marking of confidential information contained within it. The document should act as a method of detailing any inaccuracies found and how they should be corrected.

If you do identify any factual inaccuracies or errors in the marking of confidential information, you must inform NICE by **5pm on Friday 12 January 2024** using the below comments table.

All factual errors will be highlighted in a report and presented to the appraisal committee and will subsequently be published on the NICE website with the committee papers.

Please underline all confidential information, and information that is submitted as **confidential** should be highlighted in turquoise and all information submitted as **depersonalised data** in pink.

Issue 1 Inaccurate description of the TADPOLE trial

Description of problem	Description of proposed amendment	Justification for amendment	Response
<p>Inaccurate description of the duration of treatment in the TADPOLE trial.</p> <p>Page 4 states “<i>The duration of treatment is limited to 80 weeks in the clinical study</i>”.</p> <p>Page 83 states “<i>The mean treatment duration was 80 weeks to assess the safety profile of D+T.</i>”</p> <p>Page 176 states “<i>Finally, the mean duration of D+T treatment was 80 weeks in TADPOLE</i>”</p> <p>Page 177 states: “<i>Finally, like the LGG population, the mean duration of D+T treatment was 80 weeks in TADPOLE</i>”</p>	<p>This statement doesn’t accurately reflect duration of treatment in the TADPOLE trial. Please consider removing or amending these statements to be accurate.</p> <p>Please further consider amending any related texts where this is presented.</p>	<p>As stated in document B of the CS, for the LGG cohort (Section B.2.10.1.2, page 76), the median duration of follow-up was 39.0 months (range: 28.0–55.5).</p> <p>The median duration of exposure to dabrafenib (Section B.2.10.1.1, page 76) was 140.0 weeks (range: 2.7–218.6), and exposure to trametinib was 135.1 weeks (range: 2.7–218.6).</p> <p>For the HGG cohort (Section B.2.10.2.2, page 82), the patient median duration of follow-up was 45.2 months (range: 31.9–61.2). The median duration of exposure to both dabrafenib and trametinib was 121.1 weeks (range: 1.3–213.4) at the time of the final analysis DCO (section B.2.10.2.1, page 82)”</p>	<p>On page 83, the text has been amended as follows:</p> <p>“The main uncertainties in the clinical evidence primarily relate to duration of treatment and follow-up to assess the safety profile of D+T. For the LGG cohort the median duration of exposure to dabrafenib was 140.0 weeks and exposure to trametinib was 135.1 weeks, and the median duration of follow-up was 39 months. In the HGG cohort the median duration of exposure to both dabrafenib and trametinib was 121.1 weeks at the time of the final analysis DCO and the median duration of follow-up was 45.2 months.”</p> <p>Similar changes have been made on pages 4, 176, 177</p>

<p>Page 177 states: “<i>Longer term follow-up of the patients recruited into the TADPOLE study will help inform whether the treatment continuation on D+T is an important issue to consider or not.</i>”</p>	<p>Please consider removing or amending this statement to be accurate.</p>	<p>It is inaccurate to state that longer term follow-up of patients recruited in TADPOLE will help inform this assumption as data from the final DCO were presented and used in the clinical and economic section of the CS.</p>	<p>Not a factual error. Longer term data on time on treatment would help inform treatment discontinuation assumptions.</p>
--	--	--	--

Issue 2 Inaccuracy of data points

Description of problem	Description of proposed amendment	Justification for amendment	EAG response
<p>In Section 3.2.6.1.2, page 41, it states, “<i>Among the 40 responders (CR or PR) in the D+T arm...</i>”</p>	<p>We propose to amend the sentence to the following: “Among the 43 responders (CR or PR) in the D+T arm...”</p>	<p>Three patients in the D+T arm experienced complete response, while 40 patients in the D+T arm achieved a partial response.</p>	<p>Not a factual error. We were referring to the blinded independent review results. For clarity, we have amended the first sentence in this paragraph on page 41 to read</p> <p>“As reported by the independent reviewer, progressive disease as best response was 5.5% in D+T patients and</p>

			24.3% in C+V patients.”								
<p>Table 9, page 44 has a pasting error in the Primary analysis data cut column for 24-month KM event-free estimates:</p> <table border="1"> <tr> <td>24 months</td> <td>46.4 (20.6, 68.9)</td> <td>NE (NE, NE)</td> <td>100.0 (100.0, 100.0)</td> </tr> </table>	24 months	46.4 (20.6, 68.9)	NE (NE, NE)	100.0 (100.0, 100.0)	<p>We propose to amend the columns to the following:</p> <table border="1"> <tr> <td>46.4 (20.6, 68.9)</td> <td>NE (NE, NE)</td> <td>100.0 (100.0, 100.0)</td> <td>NE (NE, NE)</td> </tr> </table>	46.4 (20.6, 68.9)	NE (NE, NE)	100.0 (100.0, 100.0)	NE (NE, NE)	<p>There is an error in the reporting of 24-month KM event-free estimates for DOR.</p>	<p>Proposed amendment is accurate and implemented.</p>
24 months	46.4 (20.6, 68.9)	NE (NE, NE)	100.0 (100.0, 100.0)								
46.4 (20.6, 68.9)	NE (NE, NE)	100.0 (100.0, 100.0)	NE (NE, NE)								

Issue 3 Inaccurate description of the HRQoL SLR

Description of problem	Description of proposed amendment	Justification for amendment	EAG
<p>Inaccurate description of the HRQoL SLR.</p> <p>Page 10 states “<i>To identify utility values the company conducted an SLR of glioma in adults and then applied these values to children</i>”.</p>	<p>It is inaccurate to describe that the HRQoL SLR only considered adult studies. Please consider removing or amending these statements to be accurate.</p> <p>Please further consider amending related texts.</p>	<p>The SLR included all studies irrespective of age, as indicated by the PICO (Table 5, Appendix H).</p>	<p>Thank you for pointing out this factual we have made the following amendments</p> <p>Page 10</p> <p>All studies used by the company to obtain utility estimates were conducted in an adult population. These utility</p>

<p>Page 84 states “HRQoL studies in adults with glioma (CS², Appendix H)”</p> <p>Page 84 states “The EAG also notes that the company’s review would miss any studies on HRQoL in children with glioma.”</p> <p>Page 85 states “The inclusion and exclusion criteria for the three reviews are presented in Error! Reference source not found., Error! Reference source not found. and Error! Reference source not found.. These are generally appropriate for the reviews, albeit the EAG does have general concerns about using HRQoL from adults directly in a paediatric population. These concerns are given in greater detail in Section Error! Reference source not found..”</p> <p>Page 144 states: “The EAG believes that company should have searched for all HRQoL values related to glioma and</p>			<p>changes were then applied in a population who are all children</p> <p>“Unknown, if the current utility values are invalid for children, then sensitivity analyses using current utility values are of minimal use in informing how sensitive the ICER will be.”</p> <p>Page 84 This sentence has been removed</p> <p>Page 85 The 2nd half of this text has been removed from this section and the text on page 89 (section 4.1.4) now reads: “The utilities review did identify studies in adults that were used in the CS and are discussed in Sections 4.2.5.1.10 and 4.2.5.2.5. Albeit the EAG</p>
--	--	--	---

not just restricted the search to adult populations as this would be good practice.”

Page 150 states: “*Utilities, only values in adults were searched for*”

does have general concerns about using HRQoL from adults directly in a paediatric population. These concerns are given in greater detail in Section 4.3.7.3.”

The first sentence on page 144 now reads:

“All of the studies used to inform the utilities in the company’s model were conducted in adults. The EAG believes that this is important to consider when interpreting the results of both the company’s and the EAG’s exploratory analyses.”

On page 150, the amended text reads

“2. Utilities, all values were sourced from studies in adults”

Issue 4 Inaccurate description of the treatment duration assumed in the economic model

Description of problem	Description of proposed amendment	Justification for amendment	EAG response
<p>Page 118 (Section 4.2.5.2.4) states: <i>“Patients were assumed to discontinue their D+T at the earliest of progression or death (PFS), at 3.71 years or upon independent treatment discontinuation. The time to progression or death is described in Section Error! Reference source not found.</i></p> <p><i>The assumption of discontinuation of D+T at 12.5 years was included in the model, on the basis of the company’s clinical expert’s opinion that treatment would be unlikely to be stopped, but a small fraction of patients may stop treatment.(CS², page 115) This is implemented in the company’s economic model as a stopping rule in which treatment will stop after 3.71 years.”</i></p>	<p>Inaccurate description of the time on treatment assumed in the economic model for the HGG cohort.</p> <p>Please amend to::</p> <p><i>“Patients were assumed to discontinue their D+T at the earliest of progression or death (PFS), at 3.71 12.5 years or upon independent treatment discontinuation. The time to progression or death is described in Section Error! Reference source not found.</i></p> <p><i>The assumption of discontinuation of D+T at 12.5 years was included in the model, on the basis of the company’s clinical expert’s opinion that treatment would be unlikely to be stopped, but a small fraction of patients may stop treatment.(CS², page 115) This is implemented in the company’s economic model as a stopping rule in which treatment will stop after 3.71 12.5 years.”</i></p>	<p>As stated in Section B.3.2.8.1. (page 96) of document B, the base-case economic analysis assumed an informal stopping rule at 12.5 years for HGG</p>	<p>Proposed amendment is accurate and implemented.</p>

<p>Page 144 states “<i>The maximum time on D+T is assumed in the CS to be 3.71 years based on expert opinion. This means that the costs are limited to this period, but the benefits are extrapolated out to the future based on the TADPOLE LGG RCT or the ITCs using the TADPOLE HGG prospective cohort study</i>”.</p>	<p>Inaccurate description of the time on treatment assumed in the economic model and model logic. Please consider removing or amending this statement to be accurate.</p>	<p>As stated in Section B.3.2.8.1. (page 96) of document B, the base-case economic analysis assumed an informal stopping rule at 3.71 for LGG and 12.5 years for HGG.</p> <p>Furthermore, once treatment is assumed to be stopped, no benefit is assumed as the same hazard of progression is used between arms.</p>	<p>The text has been amended as follows for accuracy:</p> <p>“The maximum time on D+T is assumed in the CS to be 3.71 years in the LGG cohort and 12.5 years in the HGG cohort based on expert opinion. This means that the costs are limited to this period. Whilst the same hazard is assumed in both arms after this, this is a relative benefit. If D+T were to be used for a longer time period in clinical practice it may accrue the ratio of costs accrued and benefits received may be different than during the time on treatment in the initial 3.71 years in the LGG cohort or 12.5 years in the HGG model”</p> <p>“This means that the costs are limited to this period. Whilst the same hazard is assumed in both arms after this, this is a relative benefit. If D+T were to be used for a longer time period in clinical practice it</p>
---	---	--	--

			may accrue the ratio of costs accrued and benefits received may be different than during the time on treatment in the initial 3.71 years.”
--	--	--	--

Issue 5 Incomplete description

Description of problem	Description of proposed amendment	Justification for amendment	
<p>On page 149, the EAG states: “<i>In the no prior TMZ subgroup and independent assessment of progression, the company’s model predicts a mean survival of [redacted] ([redacted] years before PFS event, [redacted] years after PFS event [PPS]) years for D+T and [redacted] ([redacted] years before PFS event, [redacted] years after PFS event [PPS]) for TMZ. The ITC (see Error! Reference source not found.) gave median estimates of overall survival for D+T in years of [redacted] and for TMZ of 0.71, (95% CI 0.25, 1.58). For progression</i></p>	<p>Incomplete description which may mislead the interpretation of results. Please consider adding a statement along the following line (highlighted in bold).</p> <ul style="list-style-type: none"> • <i>The median OS predicted in the model was [redacted] years for D+T and [redacted] years for TMZ respectively. The median PFS predicted in the model was [redacted] years for D+T and [redacted] years for TMZ respectively.</i> “ <p>Please further consider if the statement below needs amending in light of the proposed change above.</p>	<p>The EAG compares the mean model prediction for OS and PFS with medians values from the ITC.</p> <p>Including values for the median predictions for OS and PFS provide a fairer comparison of model prediction and results from the ITC.</p>	<p>Agree with the amendment for clarity and fairness.</p> <p>In light of this information, the statement has been revised to:</p> <p>“The EAG believes that overall survival is likely to be overestimated in the TMZ arm of no prior TMZ subgroup by applying one distribution for PPS after a progression event.”</p>

<p>free survival (using independent review of progression), the median estimates (in years) were, [REDACTED] for D+T and [REDACTED] for TMZ. The EAG believes that it is difficult to judge whether the overall survival would be over, under or correctly estimated in the no prior TMZ subgroup by applying one distribution for PPS after a progression event.”</p>	<p>“The EAG believes that it is difficult to judge whether the overall survival would be over, under or correctly estimated in the no prior TMZ subgroup by applying one distribution for PPS after a progression event.”</p>		
<p>On page 149, the EAG states: “In the prior TMZ subgroup and independent assessment of progression, the company’s model predicts a mean survival of [REDACTED] years ([REDACTED] years before PFS event, [REDACTED] years after PFS event [PPS]) years for D+T and [REDACTED] (0 [REDACTED] years before PFS event, [REDACTED] years after PFS event [PPS]) for BSC. The ITC (Error! Reference source not found.) gave median estimates of overall survival for D+T in years of [REDACTED] and for BSC of 0.50, (95% CI 0.33, NE). However, it should be noted that the median OS for D+T was driven by a single event.</p> <p>For progression free survival (using independent review of progression), the median estimates (in years) were, [REDACTED] for D+T and [REDACTED] for TMZ.</p>	<p>Incomplete description which may mislead the interpretation of results. Please consider adding statements along the following line (see in bold). “The ITC (Error! Reference source not found.) gave median estimates of overall survival for D+T in years of [REDACTED] and for BSC of 0.50, (95% CI 0.33, NE). However, it should be noted that the median OS for D+T was driven by a single event.</p> <p>For progression free survival (using independent review of progression), the median estimates (in years) were, [REDACTED] for D+T and [REDACTED] for TMZ.</p>	<p>As above, the EAG compares mean model prediction for OS and PFS with medians values from the ITC.</p> <p>Including values for the median predictions for OS and PFS and some description of number of patients at risk and events provide a fairer comparison of model prediction and results from the ITC.</p>	<p>Thank you for providing the additional emphasis on the ITC results and the median results from the model.</p> <p>The text has been amended as follows: “In the prior TMZ subgroup and independent assessment of progression, the company’s model predicts a median OS of [REDACTED] years for D+T and [REDACTED] years for BSC. The company’s</p>

NE). For progression free survival (using independent review of progression), the median estimates (in years) were, [REDACTED] for D+T and [REDACTED] for TMZ.

The EAG believes that there may be a misestimation of the overall survival benefit of D+T in comparison to its comparators in the HGG, prior TMZ population. The EAG notes that it may not be possible to completely address this concern as it would require a full restructuring of the company's analyses to be compatible with its individual level simulation. To get compatible estimates of time to events at the patient level, a set of competing risks time to event analyses, with treatment discontinuation (D+T only), progression and death as the events, would need to be undertaken. This may not be possible with the available data."

The median OS in the model was [REDACTED] for D+T and [REDACTED] years for TMZ respectively. The median PFS in the model was [REDACTED] for D+T and [REDACTED] years for TMZ respectively."

Please further consider if the statement below needs amending in line with the proposed change above.

"The EAG believes that there may be a misestimation of the overall survival benefit of D+T in comparison to its comparators in the HGG, prior TMZ population. The EAG notes that it may not be possible to completely address this concern as it would require a full restructuring of the company's analyses to be compatible with its individual level simulation. To get compatible estimates of time to events at the patient level, a set of competing risks time to event analyses, with treatment discontinuation (D+T only), progression and death as the events, would need to be undertaken. This may not be possible with the available data."

model predicts a median PFS of [REDACTED] years for D+T and [REDACTED] years for BSC. The ITC (**Error! Reference source not found.**) gave median estimates of overall survival for D+T of [REDACTED] and for BSC of 0.50 years, (95% CI 0.33, NE). For progression-free survival (using independent review of progression), the median estimates (in years) were, [REDACTED] for D+T and [REDACTED] for TMZ. It should be noted that when comparing these data, that median's by definition are driven by the time at which a single event occurs. In particular, the company places emphasis on the median OS for D+T in the ITC was driven by a single event."

Issue 6 Clarity

Description of problem	Description of proposed amendment	Justification for amendment	
<p>On page 4 the issues in the indirect comparison row includes the statement, <i>“The EAG expects that patients with BRAF V600E mutations would have worse outcomes than patients without BRAF V600E mutations, so this may lead to the true effect being larger than those estimated.”</i></p>	<p>This wording may give the impression that the effectiveness of the comparator has been underestimated, when in fact it has been overestimated.</p> <p>The company suggests replacement with the following wording:</p> <p>“The EAG expects that patients with <i>BRAF</i> V600E mutations would have worse outcomes than patients without <i>BRAF</i> V600E mutations, so this may lead to an overestimation of outcomes on comparator treatments for patients with a <i>BRAF</i> V600E mutation.”</p>	<p>The submission has used the best available evidence for estimation of outcomes for patients with HGG on comparator treatments. Limitations in the available evidence indicates a bias against D+T in the analysis. The direction of bias is important to convey on this key issue.</p>	<p>We agree with this principle, we have amended the last sentence as follows.</p> <p>“So this may lead to an underestimation of the relative treatment effect of D+T.”</p>
<p>On page 7, the first row of the table for issue 6 states, <i>“To extrapolate PFS data a piecewise hybrid approach using Kaplan-Meier data followed by a parametric model at a fixed time point was adopted by the company. In the LGG population, the same rate of progression was assumed for both arms.”</i></p>	<p>This wording may give the impression that no difference was assumed between D+T and V+C whereas use of the KM data captured the delay in progression for V+C compared with D+T observed in TADPOLE.</p> <p>The company suggests replacement with the following wording:</p> <p>“To extrapolate PFS data a piecewise hybrid approach using Kaplan-Meier data followed by a parametric model at a fixed time point was adopted by the company. In the LGG population, the same rate of</p>	<p>The current wording could be misinterpreted to conclude that the analysis assumed no difference in the rate of progression for D+T and V+C.</p>	<p>Agree with the amended wording</p> <p>Issue 6 now reads:</p> <p>“In the LGG population, the same rate of progression was assumed for both arms after the period in which the KM data were used.”</p>

	progression was assumed for both arms after the period in which the KM data were used.”		
On page 69, paragraph four states “Verschuur et al. excluded patients with brainstem glioma. To keep the patient population consistent in the ITC analysis, the company excluded patients with brainstem glioma from the TADPOLE study.” And “But as neither Lashford et al., nor Verschuur et al., enrolled DMG patients, these TADPOLE11 patients were also excluded from the ITC analyses.”	We propose amending to “Verschuur et al. excluded patients with brainstem glioma. In addition, Lashford did not enroll patients with brainstem glioma. To keep the patient population consistent in the ITC analysis, the company excluded patients with brainstem glioma (may also called DMG) from the TADPOLE study.”	Diffuse brainstem glioma is officially known as a diffuse midline glioma according to new classifications published by the World Health Organisation (WHO) in 2016. Therefore, the originally paragraph is repeating the same exclusion of patients.	Thank you for providing raising this issue. The suggested amendment has been made.

Issue 7 Incorrect confidentiality marking

Location of incorrect marking	Description of incorrect marking	Amended marking	EAG response
Page 37	“In total, ██████ patients in D+T arm and ██████ patients in C+V arm experienced AEs leading to dose adjustment/interruption”	Please remove confidentiality marking	The confidentiality marking has been removed.

<p>Section 3.2.6.1.3, page 50</p>	<p>Subgroup data are not marked as confidential in EAG report, but are in the Company submission:</p>	<p>Where radiographic progression was used as an indicator to treatment, the ORR was █% (█) in the D+T arm vs █% (█) in the C+V arm (OR: █, 95% CI: █). Where radiographic progression was not used as indication to treatment, the ORR was █% (█) in D+T vs █% (█) in C+V (OR: █, 95% CI: █).</p>	<p>Sorry for this omission. The confidentiality marking has been applied to this text.</p>
<p>Page 75, paragraph three,</p>	<p>The following was incorrectly marked in the clarification questions</p>	<p>“TADPOLE enrolled approximately █ Grade III patients and █ Grade IV patients whereas MacDonald et al., enrolled 12.5% of Grade III patients and approximately three times the proportion of Grade IV patients (62.5%).“</p>	<p>This confidentiality marking has been applied.</p>
<p>Page 79, Table 19</p>	<p>The following was incorrectly marked in the clarification questions: TADPOLE WHO tumour grade (central histology) not marked as confidential in EAG report.</p>	<p>Grade II █ Grade III █ Grade IV █ Other Missing: █</p>	<p>The confidentiality marking has been applied.</p>
<p>Page 131, Figure 16</p>	<p>Incremental QALYs should be marked as CIC</p>	<p>Please mark Figure 16 (page 131) as CIC to avoid back-calculation</p>	<p>Thank you pointing out that the CIC marking has incorrectly applied to Figure 16 and 17. The CIC marking has been reapplied.</p>

Page 134, Figure 18	Incremental QALYs should be marked as CIC	Please mark Figure 18 (page 134) as CIC to avoid back-calculation	Thank you pointing out that the CIC marking has incorrectly applied to Figure 18 and 19. The CIC marking has been reapplied.
Page 137, Figure 20	Incremental QALYs should be marked as CIC	Please mark Figure 20 (page 137) as CIC to avoid back-calculation	Thank you pointing out that the CIC marking has incorrectly applied to Figure 20 and 21. The CIC marking has been reapplied.
Page 94, 95, 98, 116, 151, 153, 154	Confidentiality marking is not required	Please remove confidentiality marking in Page 94, 95, 98, 116, 153, 154	Confidentiality markings have been removed from page 94, 95, 98, 116, 153 and 154.

Issue 8 Typographical errors

Description of problem	Description of proposed amendment	Justification for amendment	EAG response
On page 10, the cell containing the response is incorrect for the question, " <i>What alternative approach has the EAG suggested?</i> ". The cell contents appear to have been incorrectly pasted from a previous table entry	Replace contents with the EAG's intended response.	The current response has been incorrectly pasted from a previous table entry.	Thank you for pointing this out, this has been amended.
On page 11, the column headings ' <i>incremental cost</i> '	Flip the two column headings.	To correct typographical error.	Thank you, this has been corrected as suggested.

Description of problem	Description of proposed amendment	Justification for amendment	EAG response
and 'Incremental QALYs' in Table 2 are transposed			
On page 14, World Health Organization is misspelled as 'World Health Organisation'	Amend 'Organisation' to 'Organization'	Organisation names should not be changed, even if report text is UK English.	Thank you, this has been corrected as suggested.
On page 17, paragraph 1, there is an extraneous 'it' in the sentence, "The draft summary of product characteristics (SmPC) would preclude this use of the therapy as a 1st line treatment for HGG patients at this time, as it the draft SmPC explicitly states that for HGG patients..."	Delete extraneous word.	To correct typographical error.	Thank you, this has been corrected as suggested.
In Section 3.2.6.1.2, page 40, it states, "Overall, there were no major concerns regarding the efficacy data between the different data cut".	We propose to amend the sentence to: "Overall, there were no major concerns regarding the efficacy data between the different data <u>cuts</u> ".	Missing plural at the end of the sentence.	Thank you, this has been corrected as suggested.
In Section 3.2.6.1.2, page 40, it states, "The overall response rate by blinded independent review by RANO criteria, ^{26, 27} demonstrated a clinically meaningful improvement	We propose to amend the sentence to: "The overall response rate by blinded independent review by RANO criteria, ^{26, 27} demonstrated	Missing plural when mentioning a group of patients.	Thank you, this has been corrected as suggested.

Description of problem	Description of proposed amendment	Justification for amendment	EAG response
<i>among the 73 patients treated with D+T (ORR: 54.8%; 95% CI: 42.7, 66.5) compared with 37 patient treated with C+V...</i>	a clinically meaningful improvement among the 73 patients treated with D+T (ORR: 54.8%; 95% CI: 42.7, 66.5) compared with 37 <u>patients</u> treated with C+V..."		
On page 41, the statement "Progressive disease as best response was 5.5% in D+V patients and 24.3% in C+V patients."	This should be corrected to "D+T"	To correct typographical error.	Thank you, this has been corrected as suggested. A search and replace has been made throughout the document with any instance of D+V being replaced with D+T or any instance of C+T replaced with C+V.
On page 65, paragraph 1 states "A summary of the design and study characteristics of the three studies included in the matching-adjusted indirect comparisons (MAIC) ..."	We propose to amend this sentence to: "A summary of the design and study characteristics of the three studies included in the ITCs"	IPTW analyses also performed so ITC is the broader term.	Thank you, this has been corrected as suggested.
On page 66, the heading for Table 15 refers to MAIC analyses when it should be ITC analyses and it is missing a reference	Update table heading to refer to ITC analyses and include reference to Table 19 for the response outcome definitions.	To correct typographical error.	Thank you, this has been corrected as suggested.

Description of problem	Description of proposed amendment	Justification for amendment	EAG response
In the last sentence of page 69, Section 3.4.1, 'Verschuur' is spelled incorrectly	Amend 'Verchuur' to 'Verschuur'	Minor typographical error as authors name is misspelt.	Thank you, this has been corrected as suggested. We have conducted a replace throughout the document to catch any other instances of this misspelling.
On page 80, paragraph two states "Both MAIC and IPTW analysis when comparing to Verschuur et al. adjusted for age and prior chemotherapy."	Please amend to "Both MAIC and IPTW analysis when comparing to Verschuur et al. adjusted for age, prior radiotherapy and prior chemotherapy."	To correct missing matching variable.	Thank you, this has been corrected as suggested.
On page 81, Table 20 references the CS as "adapted from CS Table 25 and Table 26"	Please amend to "adapted from CS Table 25 and Table 27"	To correct typographical error.	Thank you, this has been corrected as suggested.
On page 88, the heading for Table 25 refers to HRQoL whereas the table describes the review of evidence on costs	Update table heading to refer to costs (Appendix I instead of Appendix G).	To correct typographical error.	Thank you, this has been corrected as suggested.
On page 89, paragraph four states, "This was partly in partly implemented in Microsoft ® Excel 365 and	Replace sentence with "This was implemented in Microsoft ® Excel 365 augmented with Visual Basic for Applications code."	To correct grammatical error.	We have amended this to read "This was implemented in Visual Basic for Applications code, augmented with

Description of problem	Description of proposed amendment	Justification for amendment	EAG response
<i>Visual Basic for Applications code.</i>			parameter data and any necessary parameter calculations using Microsoft® Excel 365. This is because the EAG believes that core model calculations, applying time to events, accruing costs and QALYs over time are all in VBA.
On page 90, paragraph three states, “ <i>The perspective taken that of the NHS personal and social services.</i> ”	Replace sentence with, “ <i>The perspective taken is that of the NHS personal and social services.</i> ”	To correct typographical error.	Thank you, this has been corrected as suggested.
On page 91, last paragraph the reference “ <i>Section4.2.5.1.6.3</i> ” requires a space.	Insert space after the word Section	To correct typographical error.	Thank you, this has been corrected as suggested.
On page 92, an apostrophe is missing in the word “patients” in the third paragraph	Replace with “Once the events are ordered and the patient’s flow through the model...”	To correct typographical error.	Thank you, this has been corrected as suggested.
On page 95, final paragraph, contains a typographical error, “ <i>The reasons for select lognormal were (i) it provides</i>	Replace with, “ <i>The reasons for selecting lognormal were (i) it provides a good fit to the data as</i>	To correct typographical error.	Thank you, this has been corrected as suggested.

Description of problem	Description of proposed amendment	Justification for amendment	EAG response
<i>the good statistical goodness-of-fit (lowest BIC); ...</i>	<i>judged by statistical goodness-of-fit (lowest BIC); ...</i>		
In Section 4.2.5.1.4, page 96, 'Gnekow' is spelled incorrectly	Amend 'Gneckow' to 'Gnekow'	Minor typographical error as authors name is misspelt.	Thank you, this has been corrected as suggested. A find and replace has been conducted throughout the document to find any other misspellings.
In Section 4.2.5.1.5, page 96, there is a typographical error in the sentence, " <i>The event free survival curve for the ACNS0423 cohort in Jakacki et al. was digitised and the same range of parametric survival models as for the extrapolating PFS were fitted.</i> "	Replace with, " <i>The event free survival curve for the ACNS0423 cohort in Jakacki et al. was digitised and the same range of parametric survival models as for the extrapolation of PFS were fitted.</i> "	To correct typographical error.	Thank you, this has been corrected as suggested.
In Section 4.2.5.1.7, page 99, there is a typographical error in the sentence, " <i>No time to glioma specific death was sampled for people with a malignant transformation and had not progressed.</i> "	Replace with, " <i>No time to glioma specific death was sampled for people with a malignant transformation and who had not progressed.</i> "	To correct grammatical error.	Thank you, this has been corrected as suggested.

Description of problem	Description of proposed amendment	Justification for amendment	EAG response
In Section 4.2.5.1.10.2, page 104, there is a missing word in the sentence, “...however this may been due to some confusion as the company’s only refers to HGG.”	Replace with, “...however this may been due to some confusion as the company’s response only refers to HGG.”	To correct typographical error.	Thank you, this has been corrected as suggested.
In Section 4.2.5.1.10.2, page 104, there is an extraneous word in the sentence, “To get to the utility for someone with LGG before after they experienced a progression, but had not malignantly transformed to HGG...”	Replace with, “To get to the utility for someone with LGG after they experienced a progression, but had not malignantly transformed to HGG...”	To correct typographical error.	Thank you, this has been corrected as suggested.
In Section 4.2.5.1.10.2, page 104, there is an incorrect word in the sentence, “This data was taken from Vera et al., which as a retrospective cohort study of 336 patients...”	Replace with, “This data was taken from Vera et al., which is a retrospective cohort study of 336 patients...”	To correct typographical error.	Thank you, this has been corrected as suggested.
In Section 4.2.5.1.10.2, page 104, there is an incorrect word in the sentence, “In the overall cohort, the median age was 52 years old and then population was 64% male...”	Replace with, “In the overall cohort, the median age was 52 years old and the population was 64% male...”	To correct typographical error.	Thank you, this has been corrected as suggested.

Description of problem	Description of proposed amendment	Justification for amendment	EAG response
<p>In Section 4.2.5.1.10.2, page 105, there is an incorrect word in the sentence, “<i>Uncertainty was included in this decrement in the CS, as a 95% confidence interval was reported in Vera et al.</i>”</p>	<p>Replace with, “<i>Uncertainty was included in this decrement in the CS, as a 95% confidence interval as reported in Vera et al.</i>”</p>	<p>To correct typographical error.</p>	<p>We have corrected this to: Uncertainty was included in this decrement in the CS, as a 95% confidence interval that could be used to parameterise a distribution for the probabilistic analysis was reported in Vera <i>et al</i></p>
<p>In Section 4.2.5.1.11.1, page 105, there is an incorrect word in the sentence, “<i>which is equal to everyone in the C+V arm having these utility losses for a full 81-week treatment course even if they received a shorted course of treatment.</i>”</p>	<p>Replace with, “<i>which is equal to everyone in the C+V arm having these utility losses for a full 81-week treatment course even if they received a shortened course of treatment.</i>”</p>	<p>To correct typographical error.</p>	<p>Thank you, this has been corrected as suggested.</p>
<p>In Section 4.2.5.1.11.3, page 107, there are incorrect words in the sentence, “<i>The CS uses that disutility values associated with grade 3/4 AEs has been taken from a regression analysis conducted as part of TA772...</i>”</p>	<p>Replace with, “<i>The CS uses disutility values associated with grade 3/4 AEs that have been taken from a regression analysis conducted as part of TA772...</i>”</p>	<p>To correct typographical error.</p>	<p>Thank you, this has been corrected as suggested.</p>

Description of problem	Description of proposed amendment	Justification for amendment	EAG response
In Section 4.2.5.1.11.3, page 107, there is an incorrect word in the sentence, “ <i>This was calculated by adjusted the AE incidence rates...</i> ”	Replace with, “ <i>This was calculated by adjusting the AE incidence rates...</i> ”	To correct typographical error.	Thank you, this has been corrected as suggested.
Inconsistency in spelling of ‘tioguaninee’ and ‘tioguanine’ on pages 16, 109, 110, 111	Amend spelling of tioguaninee	To ensure consistency in spelling of tioguaninee	Thank you, this has been corrected as suggested. A find and replace has been applied throughout the EAG report.
In the abbreviations list for Table 31, ‘formulary’ is spelled incorrectly	Amend ‘formulary’ to formulary’	To correct typographical error.	Thank you, this has been corrected as suggested. A find and replace has been applied throughout the EAG report.
In the abbreviations list for Table 31, ‘trametinib’ is spelled incorrectly	Amend ‘trametinib’ to ‘trametinib’	To correct typographical error.	Thank you, this has been corrected as suggested. A find and replace has been applied throughout the EAG report.
In Section 4.2.6, page 126, there is an incorrect word in the sentence, “ <i>The EAG validated the company’s model parameters corresponded to the original CS...</i> ”	Replace with, “ <i>The EAG validated the company’s model parameters corresponding to the original CS...</i> ”	To correct typographical error.	Not a typographical error – this is stating that we checked the model inputs matched the CS as written, rather than we only checked the parameters that were explicitly in the CS which we believe is implied by the

Description of problem	Description of proposed amendment	Justification for amendment	EAG response
			company's suggested correction.
In Section 4.2.6, page 126, the clarity of the following sentence would be improved with quotation marks, " <i>Secondly, the function generate time, was unclear in its purpose ...</i> "	Replace with, " <i>Secondly, the function 'generate time', was unclear in its purpose ...</i> "	To improve the clarity of the text.	Thank you, this has been corrected as suggested.
In Section 4.2.8.2.1, page 139, the relevant cohort is mislabelled in the sentence, " <i>The tornado plot of the sensitivity of the LGG model is given in Figure 24.</i> "	Replace with, " <i>The tornado plot of the sensitivity of the HGG model is given in Figure 24.</i> "	To correct typographical error.	Thank you, this has been corrected to: "The tornado plot of the sensitivity of the HGG model for the no prior TMZ subgroup is given in Figure 24."
In Section 4.2.8.2.2, page 140, the following sentence is incorrect and requires updating, " <i>The ICER was most sensitive to the treatment duration and the PFS definition.</i> "	Replace with inference from Figure 25.	To correct typographical error.	Thank you, this has been amended to "The ICER was most sensitive to the parametric extrapolation model for PFS and the treatment duration."
In Section 4.2.8.3.1, page 142, the relevant cohort is mislabelled in the sentence,	Replace with, " <i>The tornado plot of the sensitivity of the HGG model is given in Figure 26.</i> "	To correct typographical error.	Thank you, this has been corrected as suggested.

Description of problem	Description of proposed amendment	Justification for amendment	EAG response
<p><i>"The tornado plot of the sensitivity of the LGG model is given in Figure 26."</i></p>			
<p>In Section 4.2.8.3.2, page 143, the following sentence is incorrect and requires updating, <i>"The ICER was most sensitive to the treatment duration and the PFS definition."</i></p>	<p>Replace with inference from Figure 27.</p>	<p>To correct typographical error.</p>	<p>The text has been amended to read</p> <p><i>"The ICER was most sensitive to parametric model used to extrapolate PFS."</i></p>
<p>In Section 4.3.7.3, page 144, there is an incorrect word in the sentence, <i>"...and the other believing that the company's base case was reasonable as a treatment would be considered at this point if the patient had not progressed, died or discontinued due to other adverse events."</i></p>	<p>Replace with <i>"... and the other believing that the company's base case was reasonable as treatment cessation would be considered at this point if the patient had not progressed, died or discontinued due to other adverse events."</i></p>	<p>To correct typographical error.</p>	<p>Thank you, this has been corrected as suggested.</p>
<p>In Section 4.3.8.1, page 145, the relevant cohort is mislabelled in the sentence, <i>"The company uses investigator determined progression from the</i></p>	<p>Replace with, <i>"The company uses investigator determined progression from the TADPOLE LGG cohort in the base case"</i></p>	<p>To correct typographical error.</p>	<p>Thank you, this has been corrected to</p> <p><i>"The company uses investigator determined progression from the</i></p>

Description of problem	Description of proposed amendment	Justification for amendment	EAG response
TADPOLE HGG cohort in the base case”			TADPOLE LGG RCT in the base case.”
In Section 4.4.2.1.4, page 156, there is a missing word in the sentence, “ <i>For the post-progression after malignant transformation as per independent review, the PPS data from the D+T HGG cohort (pooled TMZ status) was used.</i> ”	Replace with, “ <i>For post-progression mortality after malignant transformation as per independent review, the PPS data from the D+T HGG cohort (pooled TMZ status) was used.</i> ”	To correct typographical error.	Thank you, this has been corrected as suggested.
In Section 5.3.7.1, page 169, there is an missing word in the sentence, “ <i>The biggest driver of the different is the different assumptions the EAG prefer around the modelling of progression free survival.</i> ”	Replace with, “ <i>The biggest driver of the different ICERs is the different assumptions the EAG prefer around the modelling of progression free survival.</i> ”	To correct typographical error.	Thank you, this has been corrected as suggested.
In Section 5.3.7.2.3, page 171, the following sentence requires clarification, “ <i>The ICER changes from £21,512 per QALY gained to £16,636 per QALY gained.</i> ”	Replace with, “ <i>The ICER changes from £21,512 per QALY gained to £16,636 per QALY gained when PPS is doubled in the control arm.</i> ”	To correct typographical error and for clarity	Thank you, this has been corrected as suggested.

Description of problem	Description of proposed amendment	Justification for amendment	EAG response
<p>In Section 5.3.7.2.4, page 172, the following sentence requires amendment, “<i>This is potentially important, however important this will depend on the final licence and the final summary of product characteristics.</i>”</p>	<p>Replace with, “<i>This is potentially important, but the magnitude of impact will depend on the final licence and the final summary of product characteristics.</i>”</p>	<p>To correct a grammatical error.</p>	<p>Thank you, this has been corrected as suggested.</p>
<p>In Section 5.3.8.2.2, page 174, the following entry in Table 75 is missing a hyphen, “ Use a oneknot odds spline model for post-progression survival for patients with progressed HGG”.</p>	<p>Replace, ” Use a one-knot odds spline model for post-progression survival for patients with progressed HGG”.</p>	<p>To correct typographical error.</p>	<p>Thank you, this has been corrected as suggested. A find and replace has been done so this corrected throughout the EAG report</p>
<p>In Section 5.3.8.2.2, page 174, the report states, “<i>This scenario shows that even if 10% of all vials were to spilled or broken, the ICER would only increase from £27,500 per QALY gained in the base case to [REDACTED] per QALY gained.</i>”</p>	<p>For clarity,we propose the sentence is amended to: “<i>This scenario shows that even if 10% of all vials were to <u>be</u> spilled or broken, the ICER would only increase from £27,500 per QALY gained in the base case to [REDACTED] per QALY gained.</i>”</p>	<p>To correct typographical error and for clarity</p>	<p>Thank you, this has been corrected as suggested.</p>
<p>In Section 5.3.8.2.3, page 175, the following sentence requires clarification, “<i>The ICER</i></p>	<p>Replace with, “<i>The ICER changes from £27,500 per QALY gained to</i></p>	<p>To correct typographical error and for clarity</p>	<p>Thank you, this has been corrected as suggested.</p>

Description of problem	Description of proposed amendment	Justification for amendment	EAG response
<i>changes from £27,500 per QALY gained to £18,784 per QALY gained.”</i>	<i>£18,784 per QALY gained when PPS is doubled in the control arm.”</i>		

Issue 9 Missing detail

Description of problem	Description of proposed amendment	Justification for amendment	EAG amendment
On page 66, Table 15 is missing columns that refer to number of prior treatments and prior treatments to align with Table 18.	Add the “number of prior treatments” and “prior treatment” columns from Table 15 in the CS, Appendix D and add the following sentence to page 69, paragraph 6. “TADPOLE and Lashford et al. enrolled patients with ≥1 prior treatments, whereas Verschuur et al. did not restrict enrolment by number of prior treatments.”	The detail is included for Section 3.4.2, so for consistency it needs adding to Section 3.4.1.	This is not a factual error but the suggested column and text has been added for consistency.

Issue 10 Correction of errors in the CS

Description of problem	Description of proposed amendment	Justification for amendment	EAG response
On page 19 (table 2), the CS incorrectly used the term vial to describe trametinib (Spexotras®) instead of the term bottle (as used on page	Please consider replacing the term “vial” by “bottle” for trametinib in the following places of the EAG report <ul style="list-style-type: none"> Page 110 (Table 31) 	The correct term to describe trametinib container as per the SmPC is bottle (used in terms of tablets, capsules or powder for reconstitution) and that	Thank you for the clarification, the term “vial” to describe trametinib has been replaced throughout with “bottle”.

<p>125 of the CS). This is likely to have contributed to the wrong terminology used by the EAG when describing trametinib container.</p> <p>Please accept our apologies.</p>	<p>Bottle Vial</p> <ul style="list-style-type: none"> • Page 110 <p><i>“The EAG’s clinical advisors did not comment on the use of trametinib, however the same concerns are unlikely to apply to the same extent for trametinib, as whilst it is in a vial bottle it is an oral therapy given at home”</i></p> <ul style="list-style-type: none"> • Page 144 <p><i>“Furthermore, the EAG notes that trametinib appears to be made from a powder into bottle vials for patients to administer (the draft SmPC for oral trametinib was not available to the EAG).”</i></p> <ul style="list-style-type: none"> • Page 168 <p><i>“Table 1 shows the effect of scenarios on adding in wastage/spillage of the trametinib vials. The EAG believes that this shows that the EAG’s ICER is largely insensitive to increased wastage of the bottle vials of trametinib”</i></p> <ul style="list-style-type: none"> • Page 168 <p><i>“Table 1: Scenario analysis of adding in a proportion of wastage of the bottle vials of trametinib”</i></p>	<p>should be used. Vials are used to refer to small container for an injectable product.</p>	
--	--	--	--

	<ul style="list-style-type: none">• Page 171 <p><i>“Table 2: Scenario analysis of adding in a proportion of wastage of the bottle vials of trametinib in the HGG population who have previously received TMZ”</i></p> <ul style="list-style-type: none">• Page 174 <p><i>“Error! Reference source not found. s hows the results of the EAG’s scenarios of increasing the wastage of trametinib as it distributed in bottle vials, so there may be some spillage and breakage. This scenario shows that even if 10% of all bottle vials were to spilled or broken”</i></p>		
--	---	--	--